

LIGHTNING PROTECTION OF ROOF-MOUNTED SOLAR CELLS

F. D. Martzloff
GENERAL ELECTRIC COMPANY
Schenectady, New York

Working paper developed for a NASA-sponsored study of solar cells

Significance

Part 6: Tutorials, textbooks and reviews

Lightning interception by an unprotected building 30 feet high x 45 feet long on flat land, in the Cleveland area, can be estimated at one strike per 200 years on the average. However, peculiar configuration can easily affect this estimate upward or downward. Means are available to install air terminals so that interception will be done by these, without harm to the roof-mounted photovoltaic array. Economic trade-off on the decision to invest in a lightning protection system during the life of the development project must also include intangible factors such as schedule delays and postmortem apologies for insufficient protection.

LIGHTNING PROTECTION FOR ROOF-MOUNTED SOLAR CELLS

1.0 INTRODUCTION

This discussion is presented as an introductory guideline to alert system designers and provide a basic understanding of the phenomena governing the techniques of lightning protection. No definitive numerical prediction is given at this time, pending availability of architectural details; an example of estimated interception rate is given for an assumed building in the Cleveland area.

A brief description is given of the lightning phenomena, as well as of the basic concepts which need to be understood for effective application of protective techniques. Prevention of direct effects, that is, the effects associated with current flow in the system, to be avoided, is first discussed. Indirect effects are also mentioned, and the document is completed by a bibliography for further reading by interested designers, and an Appendix discussing in more detail the history and rationale of the cone of protection concept.

2.0 LIGHTNING PHENOMENA

The phenomenon of lightning has been the subject of intensive study by many workers (see bibliography) and its behavior is fairly predictable in general terms, although the exact description of specific incidents is not predictable. Protection against lightning effects includes two categories: direct effects concerned with the energy, heating, flash, ignition of the lightning current, and indirect effects concerned with induced overvoltages in nearly electrical and electronic systems.

Claims to the contrary notwithstanding, there is no conclusive evidence that lightning can be prevented. Consequently, one has to design and implement a facility to recognize the possibility of a lightning strike, and take appropriate measures to make this strike harmless. Lightning protection is then an approach where one can make the proper moves if the characteristics of the enemy are anticipated.

Two concepts must be understood to apply effective lightning protection devices: the "cone of protection" and the "striking distance." These will be discussed with some detail in the following pages. Other fundamentals of electricity such as the impedance of a circuit to fast-changing currents impulses are assumed familiar to the reader.

We will first review current theories on the formation of lightning, then go on to the concept of the cone of protection and striking distance. The following descriptions are based on the work and papers of Fisher, Cianos & Pierce, and Golde.

2.1 Generation of the lightning flash

The energy that produces lightning is provided by warm air rising upward into a developing cloud. In detail, several theories vary, but all are based on the observed evidence that the cloud, except for the top, is negative, with

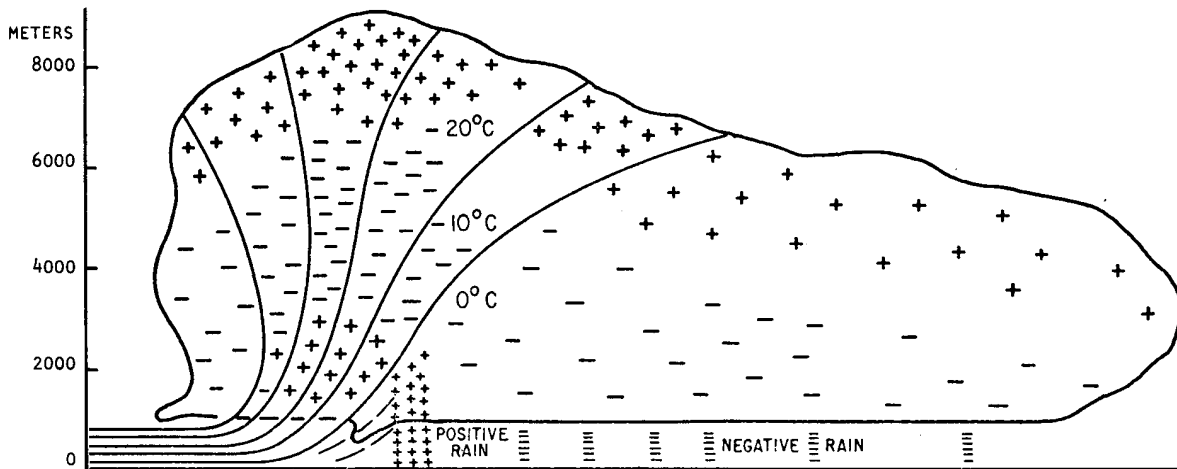

Figure 2-1

Generalized diagram showing distribution of air currents and electrical charge distribution in a typical cumulonimbus

a small body of positive charge near the front base of the cloud. Figure 2.1 shows a typical cloud distribution of charges; the solid lines represent the direction of the air movement in the cloud, with the cloud moving from right to left. As the cloud passes over a point on the ground, an electrical charge is attracted under the cloud on the ground. The average electric field at the surface of the ground will change from its fair-weather value of about 300 volts/meter to several thousand volts/meter. The gradient will be concentrated around sharp protruding points on the ground, and can exceed the breakdown strength of air, typically 30 kV/cm.

However, the first significant event toward formation of a lightning flash occurs at the cloud. A slow-moving column of ionized air forms at the cloud, called pilot streamer, moving by steps of 30 to 50 meters, and followed by a more intense discharge called step-leader, because of the discontinuous process of ionization and filling of the column with charged particles.

The step-leader does not move in straight line towards the ground, but seeks out the path with least electrical resistance, producing the familiar zig-zag pattern of the final stroke, with branches as several paths may be formed in the process of searching a weak path. The interval between the successive steps is about 50 microseconds, allowing progressive build-up of charges on the ground as the charged column advances toward the ground. Finally, a stage is reached with the step-leader being one step only away from the ground, when the last step is completed, either by continuation of the process, or by meeting a leader of positive charges originating from the ground. We will discuss the implications of this in some detail in the section dealing with the striking distance concept.

With the path now completed, a positive charge then flows upward from the ground into the negative channel left in the wake of the step-leader, neutralizing the charge in this channel and moving at roughly one third of the speed of light. This is what constitutes the lightning stroke, carrying the current at peaks of 1000 to 100,000 amperes, with a decrement to half-value in the order of 50 microseconds. The first one of these which occurs in a flash is called the return stroke.

The first return stroke neutralizes the ionized column as well as a small pocket of charges in the cloud; a second or more return strokes, sometimes called re-strikes or subsequent strokes, can take place, using the same ionized channel, but moving much faster. Thus, a series of strokes, such as shown in Figure 2.2, can occur in an interval in the order of a second. Each of these strokes increases from a very low quiescent value to a very high amplitude in a very short time, resulting in rates of current change up to 1×10^{11} amperes/second.

When very tall objects are present, a step-leader can actually originate from this object, and travel upward to the cloud, rather than the more general case of downward-moving leader. Subsequent charges, however, will be similar, that is, move in the ionized channel left by the first discharge.

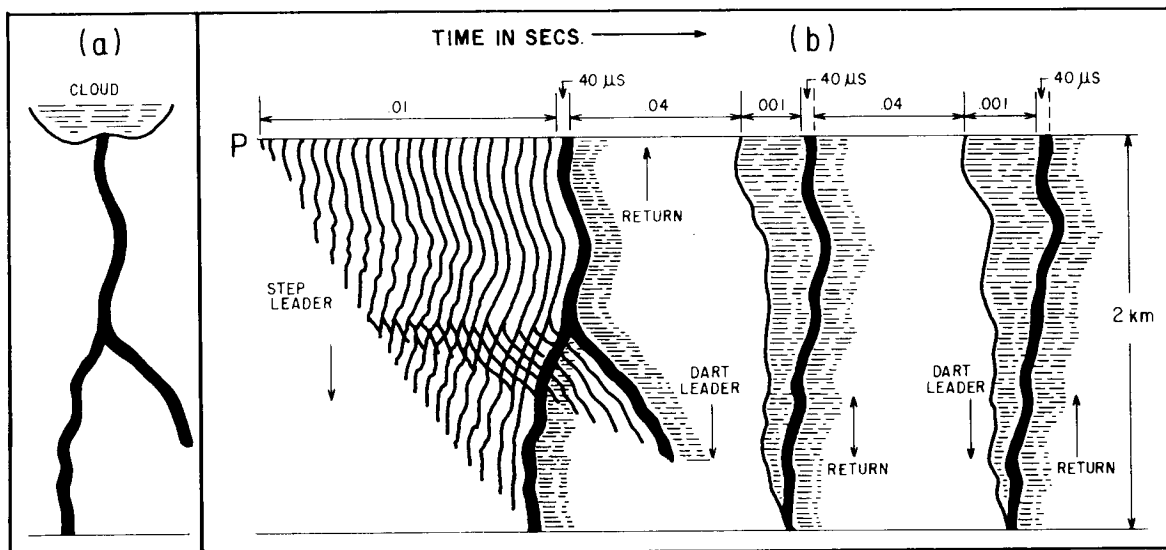

Figure 2-2

Diagram of the development of a lightning flash

- (a) Recording by conventional fixed camera
- (b) Recording by camera with moving film
resolving the progress of the leaders
(After Schonland)

In addition to the short (tens of microseconds) discharges just described, a low amplitude current can exist between the individual strokes. Although low in amplitude (a few hundred amperes), the long duration of this continuing current (tens to hundreds of milliseconds) is significant because of its total charge, resulting in most of the burning and metal-melting effects of a lightning flash.

The wave form and amplitude of lightning stroke and continuing currents vary over such a wide range that information has to be presented in statistical form; Cianos & Pierce have published a comprehensive set of statistics, from which the data of Figures 2-3 through 2-8 are derived, giving the reader a feel for the orders of magnitude involved.

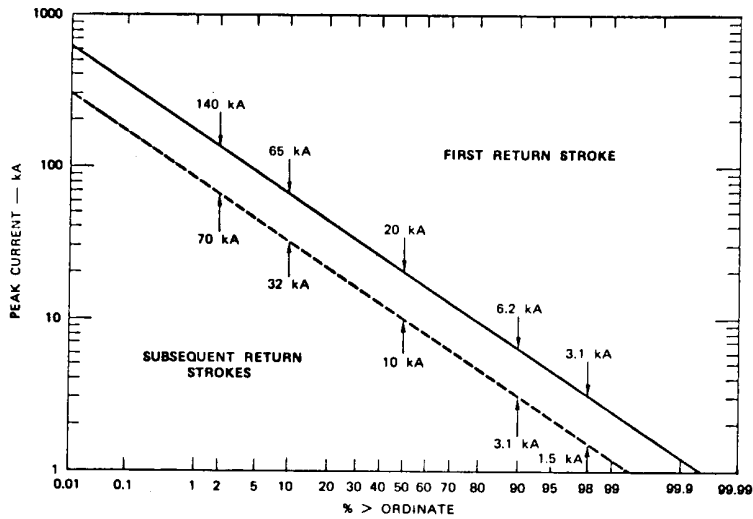

Figure 2-3
Distribution of peak currents
for first return stroke and
subsequent strokes

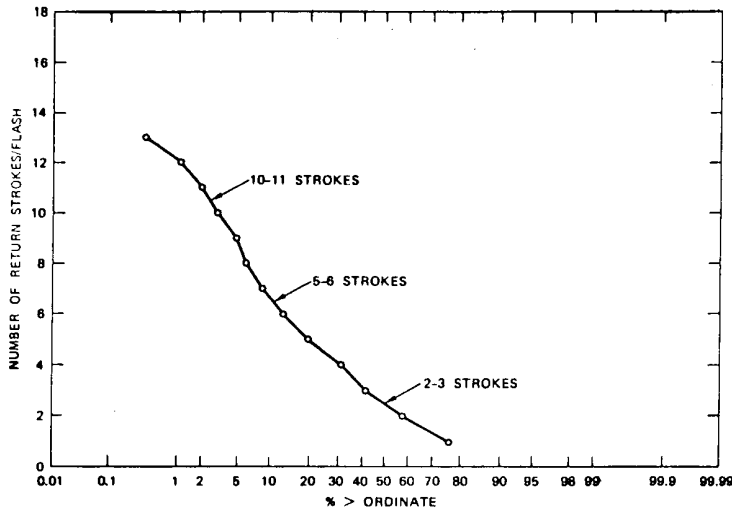

Figure 2-4
Distribution of the number
of return strokes per flash

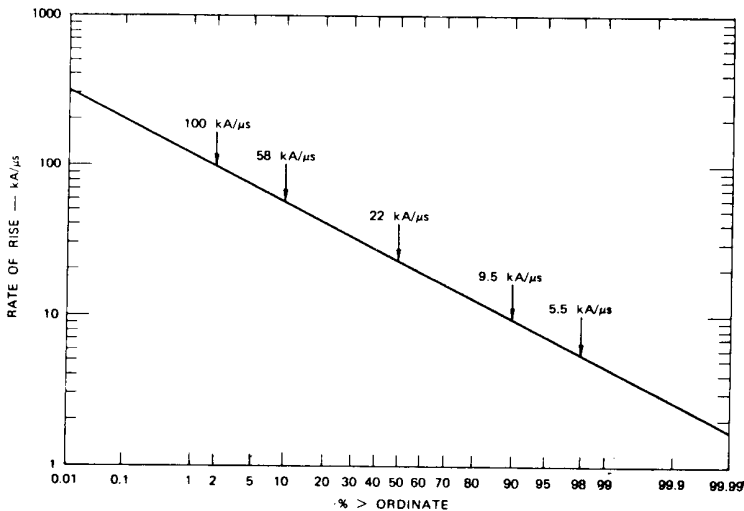

Figure 2-6
Distribution of rates of rise

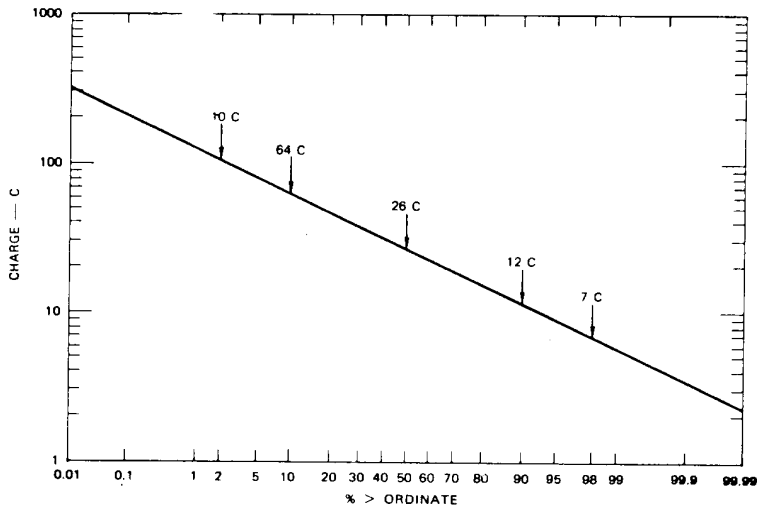

Figure 2-6
Distribution of charges in
continuing current

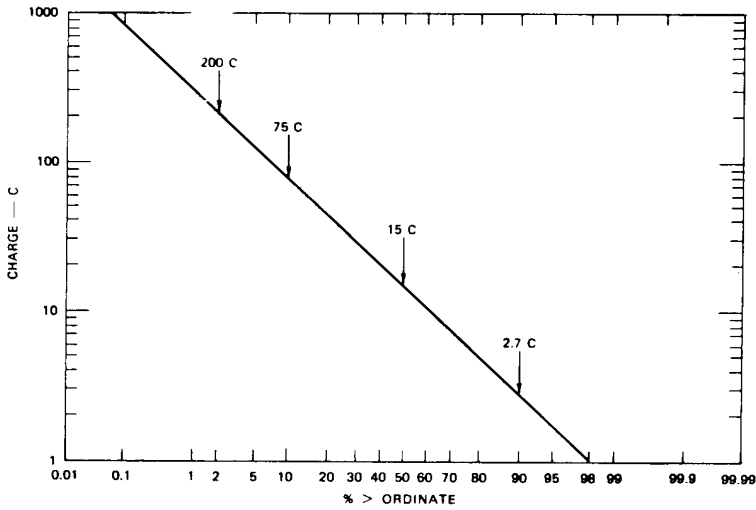

Figure 2-7
Distribution of charge/flash

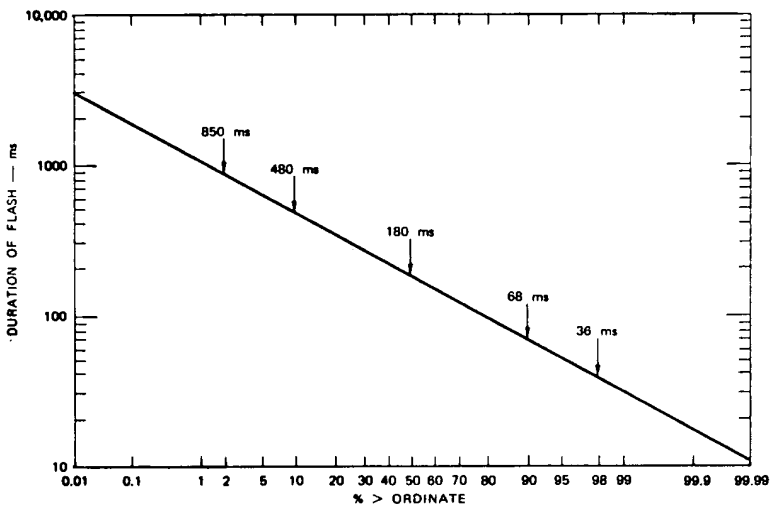

Figure 2-8
Distribution of duration of
flashes to earth

2.2 Frequency of occurrence

One of the major factors to consider in determining the probability of lightning damage, and thus the need for strong protection, is the number of lightning flashes to earth in a given area for a given time. This is not generally available, and instead the number of "thunderstorm days" is quoted. However, this does also include the cloud-to-cloud discharges, and does not represent an accurate parameter, since it does not include the duration and intensity of each storm. Progress is being made in improved statistics, but these are not yet available, and therefore the "isokeraunic level" maps, showing the number of storm-days per year, is still the most widely used description of the occurrence distribution. An empirical equation has been derived, relating the density of flashes to ground and the number of storms per year, as follows:

$$\begin{aligned} \text{density in flashes per km}^2 \text{ per year: } & D \\ \text{thunderstorm-days per year:} & T \\ D = 0.02 T^{1.6} \end{aligned}$$

This corresponds to approximately 1 flash per year per km² at an isokeraunic level of 10, and 10 flashes per year per km² at a level of 40.

The significance of this situation is that, contrary to some popular beliefs, the density of lightning flashes, on the average, is independent of terrain. However, detail of the ground objects (trees, buildings, hills) will produce a bias in the local distribution of this average.

2.3 Striking distance

This distribution at the local scale is determined by the final stages of the step-leader coming from the cloud, so to speak, without knowing what it will find on the ground. Thus the actual point of termination can be somewhat controlled, while the probability of a given area to receive a lightning stroke cannot. This is where the concept of the striking distance, as explained by Golde, becomes very useful.

As the step-leader has approached the ground in the haphazard path described above, the point is reached where one more strike in the discontinuous process will close the path. The distance between the top of the leader and the object about to be struck (or about to emit the meeting leader) is called striking distance. The length of this distance is affected by the field established by the leader, which in turn is determined by the amount of charges existing in the ionized channel coming from the cloud. With large charges in the channel, the field is more intense, so that breakdown can for longer distances, while a shorter distance is necessary to produce breakdown for the weaker fields established by smaller charges. Figure 2-9 shows the relationship between the stroke current (which reflects the charge existing in the ionized channel) and the striking distance, as computed by Golde.

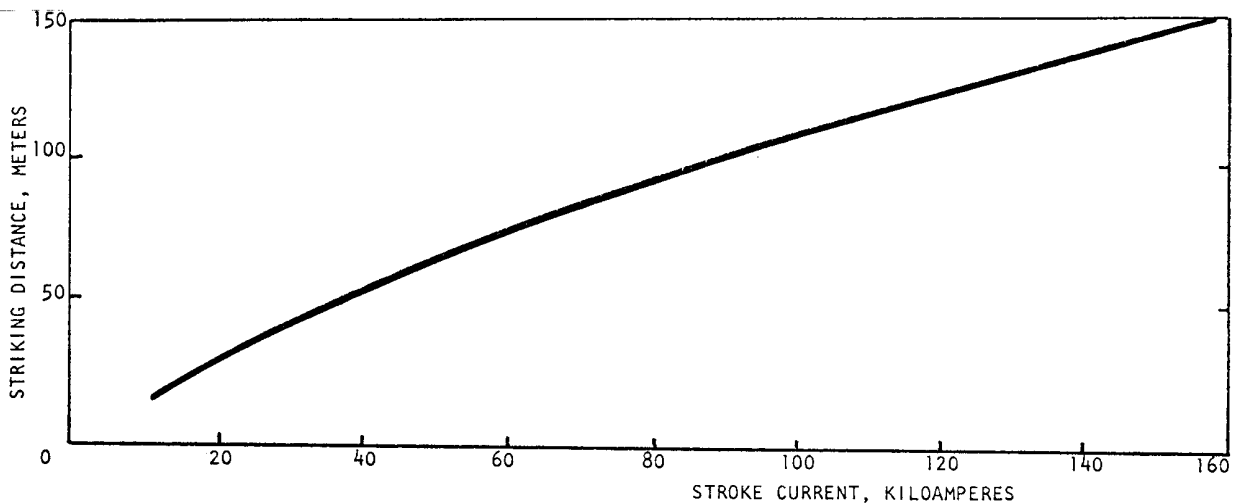

Striking distance vs current amplitude

For instance, an average lightning current of 25 kA would correspond to a striking distance of 40 meters. Thus, for an average stroke, details of the terrain do not affect the point of termination of the stroke beyond this distance, but only within this distance will there be a race, or a competition, as to which point will receive the flash, or invite it by sending a meeting streamer. Conversely, very low amplitude flashes

have an even shorter striking distance, meaning that they will ignore "attractive" points of termination, explaining some of the more puzzling exceptions to the generally assumed effect of tall structures, rods, etc. In other words, once a lightning step-leader has approached the ground within just short of the striking distance, no amount of devices beyond the striking distance will have any effect on the occurrence of the stroke, just the details of the area within the striking distance will determine the point of termination; the area is committed to receive the stroke, and it is now up to the humans controlling the shape of the objects on the ground to provide a least harmful point of termination, and make it most attractive to the approaching leader ("take me to your leader"...)

A number of photographs have been collected, and reported in the literature, showing a lightning flash approaching the ground in a somewhat wandering but generally downward direction, but with a sharp "turn" near the lower part of the path. This, according to the striking distance just described, can be readily explained as being the point where the downcoming step-leader met the upcoming leader from the ground. A photograph of a particularly clear occurrence of this will be found in the Appendix.

We are now ready to tackle the concept of the "cone of protection," having understood how the striking distance concept can explain some of the otherwise unexplained exceptions to the generally accepted and verified protection afforded by projecting objects, natural or artificial.

2.4 Cone of protection

From the days of Benjamin Franklin, the concept of a cone of protection has been used to provide effective protection of objects within the cone. Briefly, this concept states that objects contained within a cone of 1:1 or 1:2 ratio of height to radius (Figure 2-10) will not receive the lightning stroke, but that the object at the apex of the cone will. In the elementary

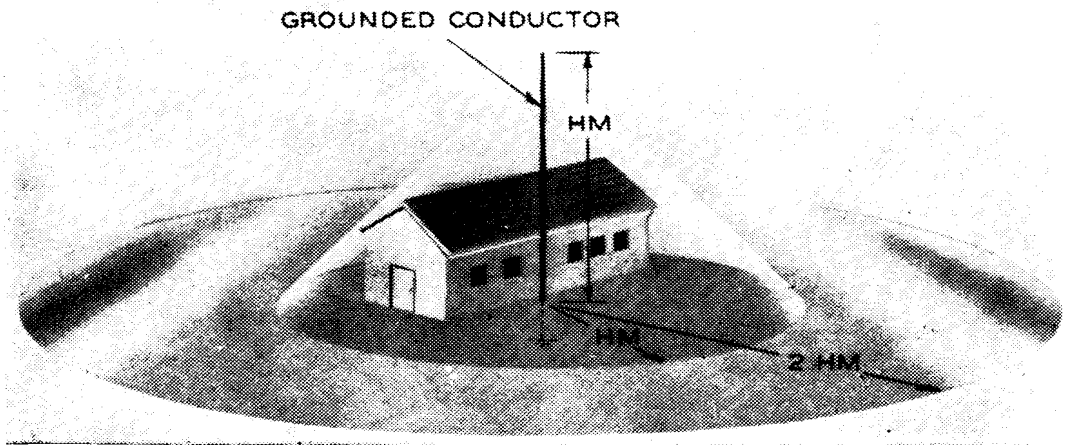

Figure A.

Cone of Protection Provided by a Vertical Grounded Conductor.

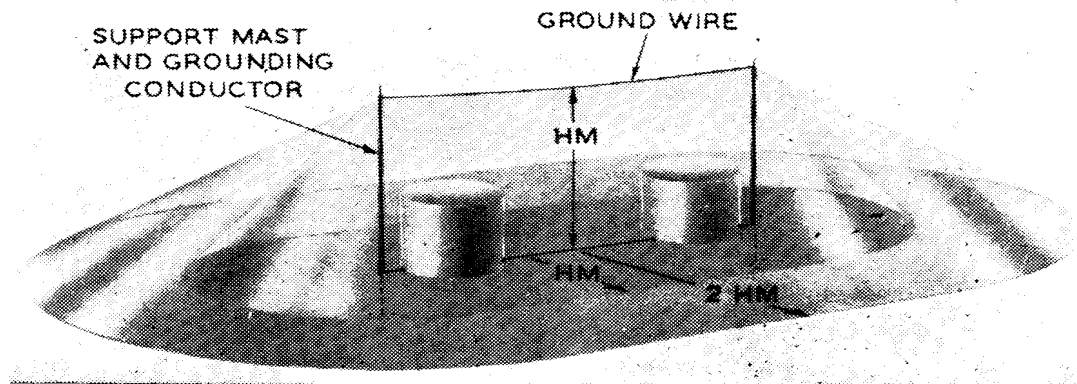

Figure B. $HM = \text{Height of Mast.}$

Zone of Protection Provided by a Horizontal Aerial Ground Wire.

Figure 2-10

Cones of protection (from NFPA 78-1975)

concept, only one projecting object above a ground plane is being considered; in most practical situations involving buildings, multiple cones will be or should be considered.

Historically, a 1:2 cone was considered acceptable. However, some exceptions to the "rule" of protection (as if Zeus should abide by "rules") have recently led to a more conservative use of a 1:1 cone of protection; the exceptions can be explained by the striking distance concept, as we shall now see.

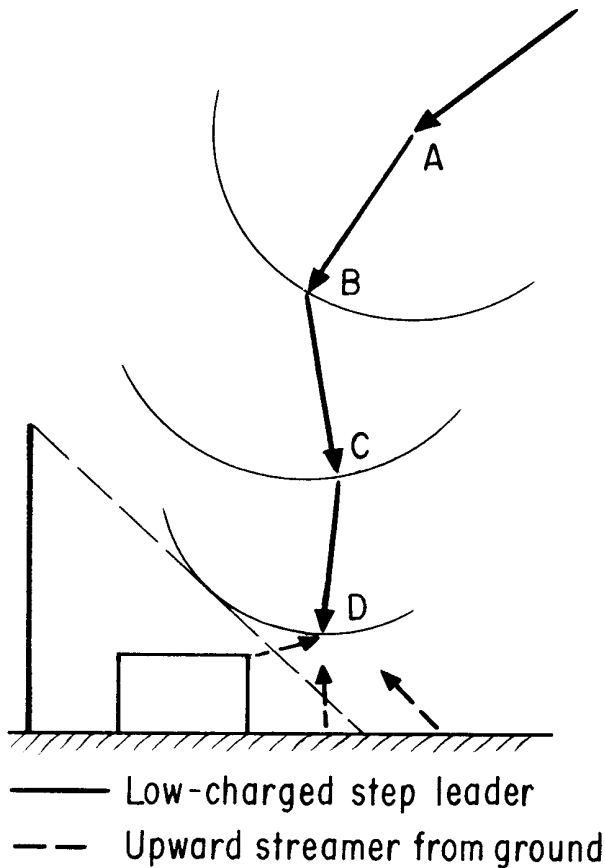

Figure 2-11

Termination of stroke with short striking distance

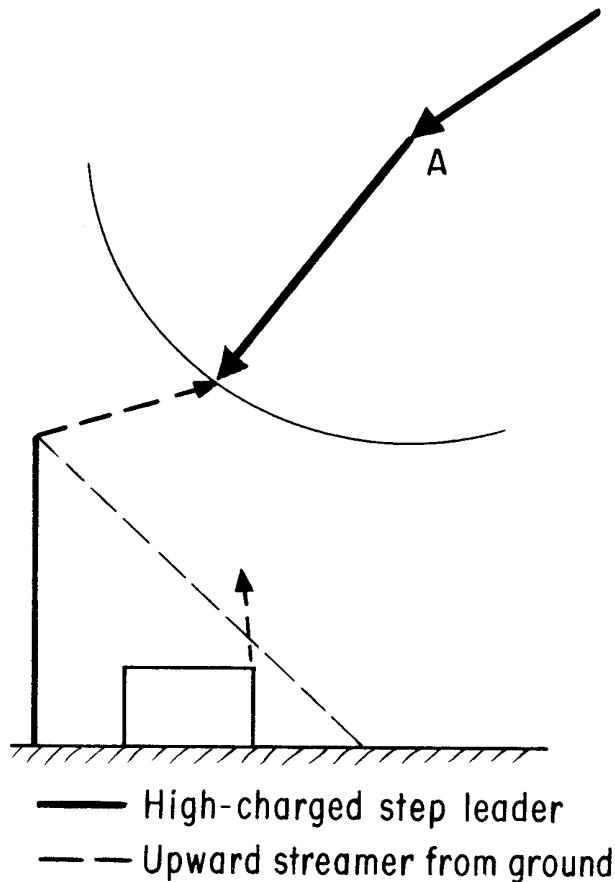

Figure 2-12

Termination of stroke with long striking distance

Classical "cone of protection" rule for the building shown in Figure 2-11 would assure that the lightning mast shown provides dependable protection for the building against an approaching step-leader. However, if we consider the striking distance shown by the circles, at each step of the leader advance, we can see that the leader will have ignored the lightning mast, and that at the fateful last decision point D, the shortest distance is to the corner of the building within the "cone of protection," rather than to ground, even less to the lightning mast. The path drawn here also exhibits

the tell-tale sharp inflexion of the last step mentioned above and often photographed.

By contrast, the step-leader drawn in Figure 2-12 for the case of a stroke with higher prospective intensity, and thus longer striking distance, will terminate at the lightning mast, starting from the same point "A" of its path. This corresponds to the classical cone of protection situation; it implies that the step-leader can find within its striking distance a point of termination which is intentional, rather than an object which happens to be close enough and shaped in a manner promoting the initiation of a streamer which will "win" the race to meet the step-leader.

Further evidence and supporting data for the concept of a cone of protection will be found in the Appendix.

3.0 DIRECT EFFECTS

3.1 Conduction of current to ground

We have now reached the state where lightning has struck, and have seen that it may strike in some rather unexpected (and unprotected) locations, and are faced next with an evaluation of the effects of the stroke and continuing current flow. In the case of a roof-top array of voltage-sensitive cells, the real story begins with the flow of current below the first metallic termination point. Therefore, lightning protection in this context will mean making sure that the lightning does terminate where we want it to terminate, and that from there it is led to earth in an acceptable manner, along a safe, controlled path.

The most important consideration is then what happens to the potential drop along the current path to ground. We have seen that the current increases very rapidly on the front of the wave. Therefore the inductive drop $L di/dt$ over the current path will be extremely large, in other words, during initial phase of the discharge, the "grounded" lightning rods and downcomers of a building network will be elevated to substantial potentials above earth ground, in the order of tens or hundreds of kilovolts. Any circuitous path in the downcomer will increase this voltage drop, with the attendant risk that a flashover may occur to bridge and shorten this path, defeating the intent of carrying the current directly to earth, away from the array.

Another consideration is the difference of potential established during the initial phase, when the current increases at extremely fast rates, between the lightning system and the cell array. The upper portions of the downcomers are elevated at very high potential because of the inductive drop, while the upper metallic parts of the array remain uninvolved in the current path, and therefore remain at "ground" potential. We are writing "ground" in quotes as this is an arbitrary definition in the context of potential distribution during a lightning stroke.

With reference to Figure 3-1, the "ground" point can be represented as the common point "G" at which the electric power system of the house is tied to the downcomer conductors; any further impedance below point "G" and "true" earth is not relevant to the difference of potential V established across the wall of the building at point A. If the length (inductance) between points B and G is large, and the distance between A and B small, the voltage V will exceed the dielectric strength of the AB gap, and a "side flash" will occur between A and B, with possible disastrous effect.

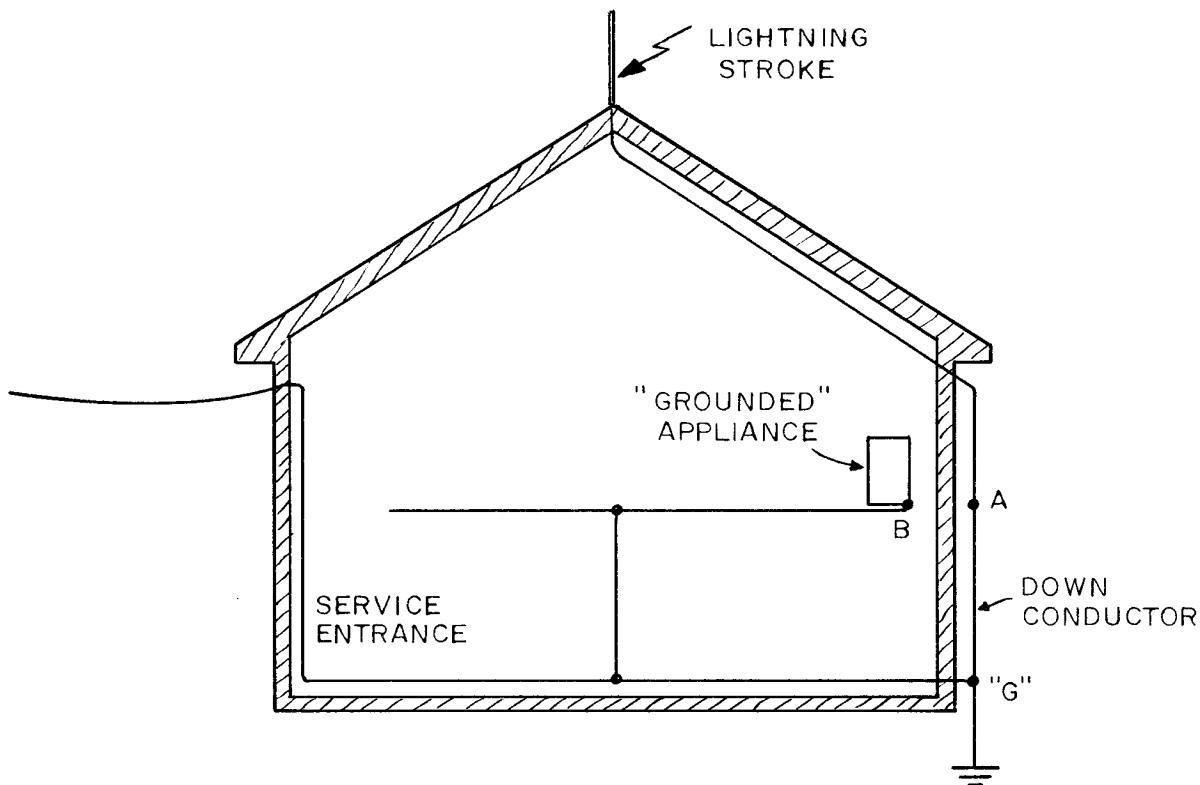

Figure 3-1
Side flash problem on lightning conductors

3.2 Design of the air terminals

Protection of an experimental roof-top array is different from the protection to be provided, if any, for future mass-produced arrays. In the case of the experimental system, the high cost of a lightning strike should prevail over aesthetic considerations, so that the objective will be to maximize protection. Once the cost of the roof array is established as a commercial product, the trade off between economics and aesthetics will be quite different. In this discussion, however, we are addressing the case of the experimental house.

There are two basic approaches to providing sufficient protection: lightning masts, at some distance from the house, with sufficient height to provide an effective cone of protection, and lightning conductors above the roof. Neither can provide absolute protection against all possible strikes; however, the likelihood of a strike attaching to the roof-mounted array will be decreased by several orders of magnitude if a properly designed system is installed.

3.2.1 Lightning masts

The discussion of paragraph 2.4 above, and the possible exception to the protection expected for a strict interpretation of the cone of protection formula, give some guidance on the design of a mast system. For the experimental model, two masts at minimum are recommended, with four being even more effective. (In the case of a project involving a group of closely spaced houses, it may be possible to provide a common mast at each lot boundary. Figure 3-2 shows how such a mast system can be implemented. One of the advantages would be complete independence of the power system and lightning system at all but one point.

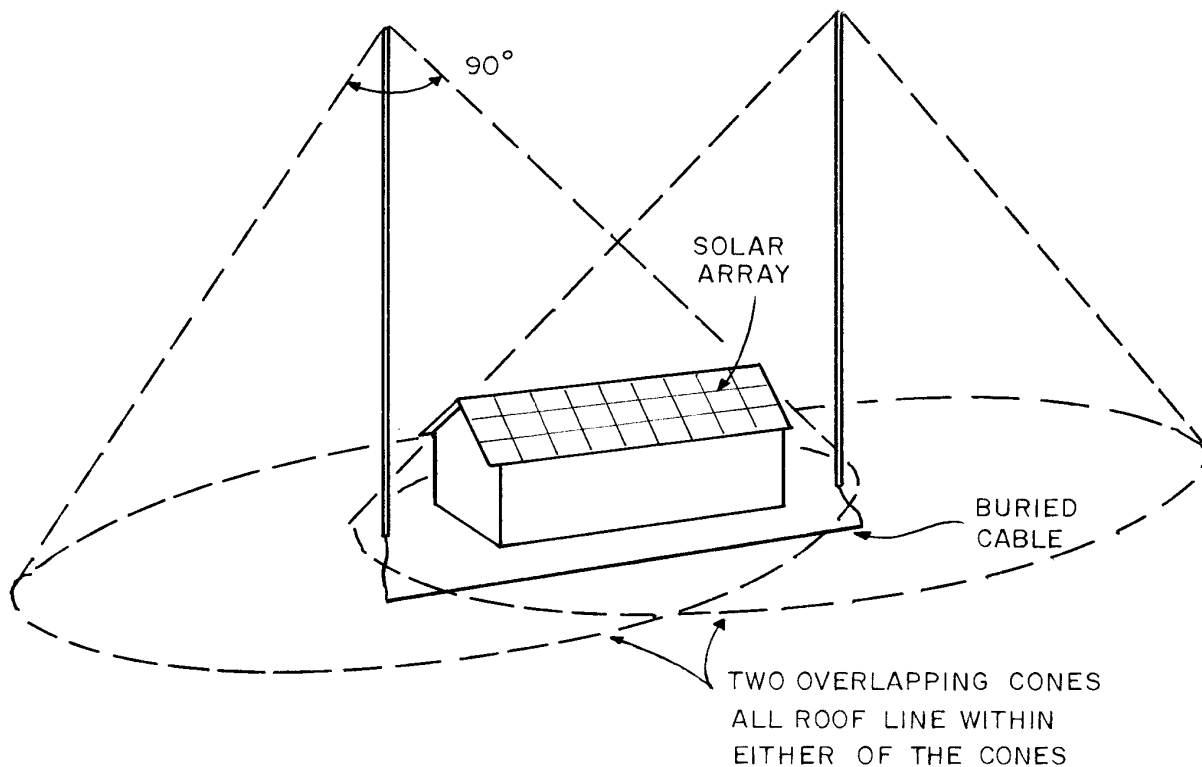

Figure 3-2. Lightning protection using two masts

3.2.2 Lightning conductors

A possibly more effective protection can be expected from a lattice of lightning conductors strung some distance above the roof. The number of conductors, and the distance from the roof are in inverse proportions. Therefore, there is a possible trade-off between a few conductors high above the roof, and many conductors close to the roof. The boundaries of the trade-off correspond to the situation where the many conductors would be so close to the roof that side-flash becomes a problem, or where only a few, very distant conductors would allow a low-amplitude stroke, with attendant short striking distance, travel around the theoretical cone of protection, as discussed in paragraph 2.4.

In any case, the down conductors for the cable lattice have to be routed far enough away from the roof to prevent any side flash. Figure 3.3 shows a possible arrangement for a cable lattice system.

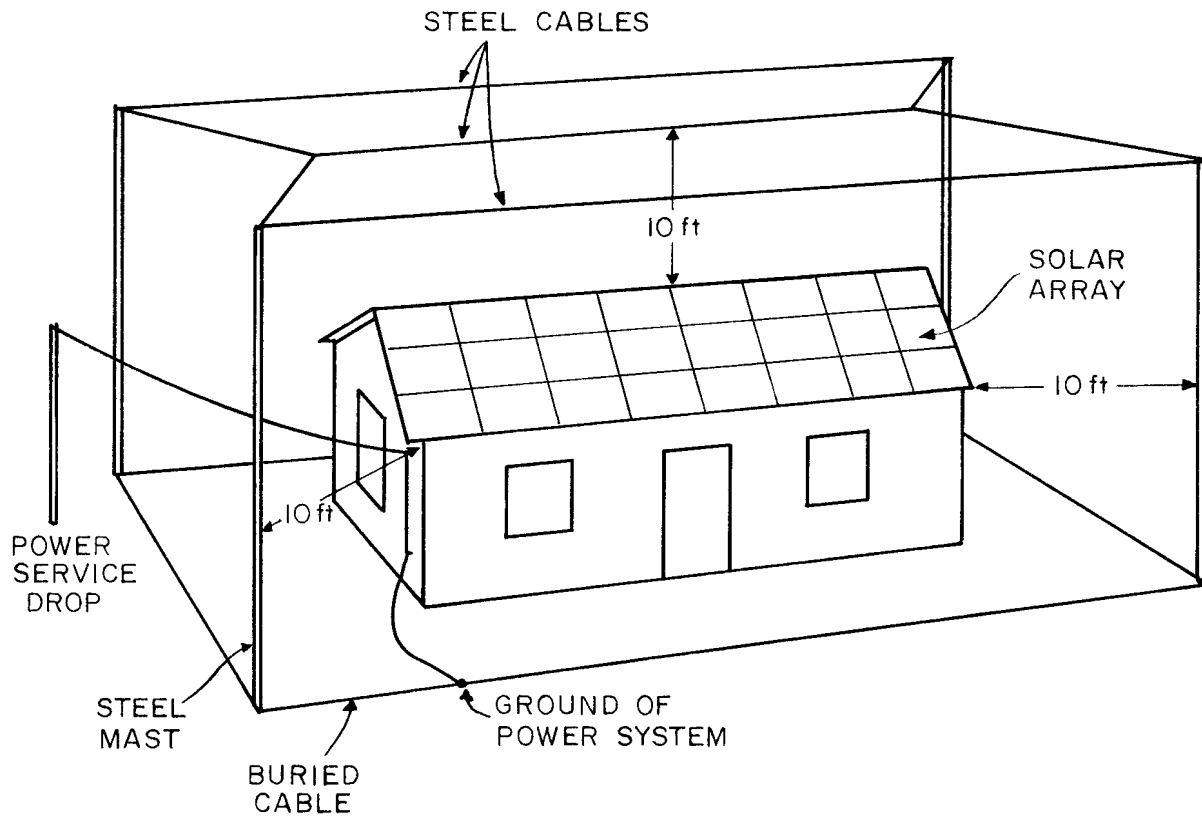

Figure 3-3. Lightning protection using overhead cables

4.0 INDIRECT EFFECTS

4.1 Indirect voltages

The major indirect effect of lightning strokes for this project is the voltage induced on the power system by the rapidly changing magnetic flux associated with the high di/dt of the lightning current. A less important but still significant effect would be the voltage produced by electrostatic coupling between the roof array and the charges associated with atmospheric electricity.

Typical lightning strokes involve currents of 50 kA reaching crest in 1 microsecond. Thus, the $d\phi/dt$ near the lightning conductors will be quite high and capable of inducing destructive voltages in any loop which would link a substantial flux from the lightning current. Therefore, the power system, cell array and control circuits must be designed to minimize intrinsic coupling, or be suitably shielded.

4.2 Effect on incoming power system

There is a certain amount of information available from various sources on the magnitude of transient overvoltage entering a house wiring system by the route of the utility service. While not exhaustive, the data collected so far have indicated that transients up to 6 kV can occur, infrequently, but still often enough to cause concern for sensitive electronics. This problem of course is not unique to photo-voltaic systems, but is faced by every appliance manufacturer.

In the present case, recognition of the problem is all that is necessary since there is a wide variety of commercial devices available to suppress these surges.

5.0 FLASH INTERCEPTION RATE

The relationship between annual thunderstorm days and flash density has been defined by empirical formulæ and plotted by Cianos & Pierce. Table 5-1 shows the computed ground flash density, obtained by multiplying the flash density by a factor relating the ground flashes to the total flashes. This factor depends on the latitude, as suggested by Cianos & Pierce.

Table 5-1
FLASHES/km²/YEAR

<u>Thunderstorm Days per year</u>	<u>Flash Density (total)</u>	<u>Ground Flash Density at 40° latitude</u>
10	0.77	0.2
20	2.52	0.7
30	4.83	1.4
40	7.69	2.1

Using the cone of protection concept in reverse, we can estimate that the effective area of an object protruding over the ground surface, in attracting a strike, increases as its height increases. For a height h , a circle of radius $2h$ can be considered as candidate for flash interception. Thus, assuming a building of 45 feet (15m) x 30 ft (10m), with a height of 30 ft (10m), the effective area is indicated by the sketch of Figure 5-1. The area corresponding to an elongated double cone originating from a roof antenna on one side and the peak of the roof on the other side, at a 2:1 angle, is approximately $50 \text{ m} \times 50 \text{ m} = 2500 \text{ m}^2 = 0.0025 \text{ km}^2$.

Applying the ground flash density of Table 5-1 for an isokeraunic level of 40 (see map of Figure 5-2), we obtain an estimated interception rate of $0.0025 \times 2.1 = 0.005$ flashes per year on the area covered by the house and its associated cones.

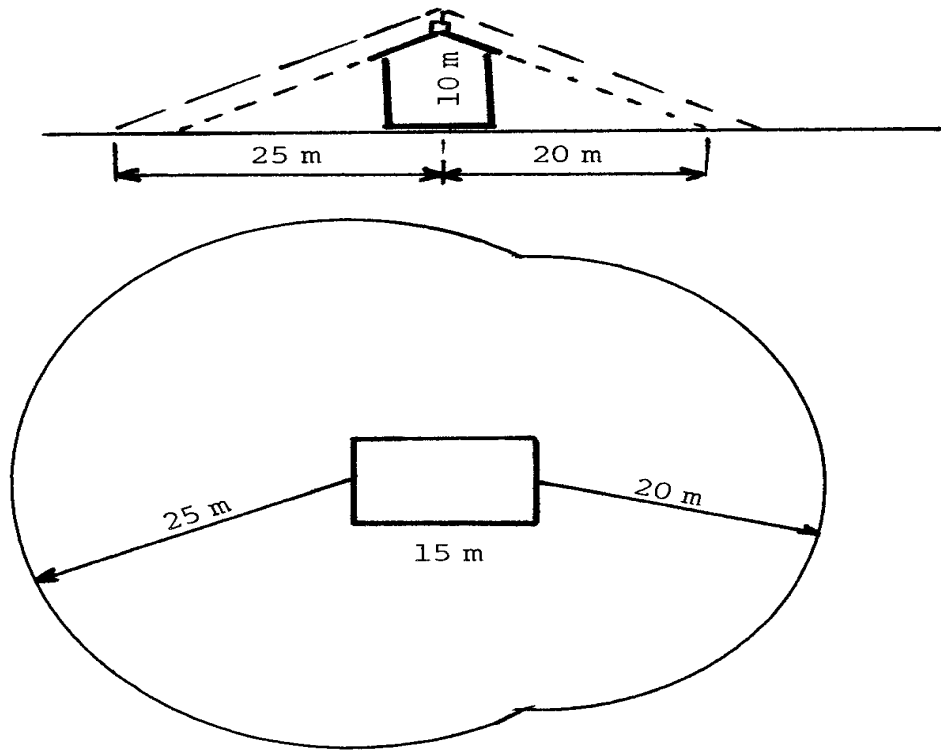

Figure 5-1. Interception area of a typical house

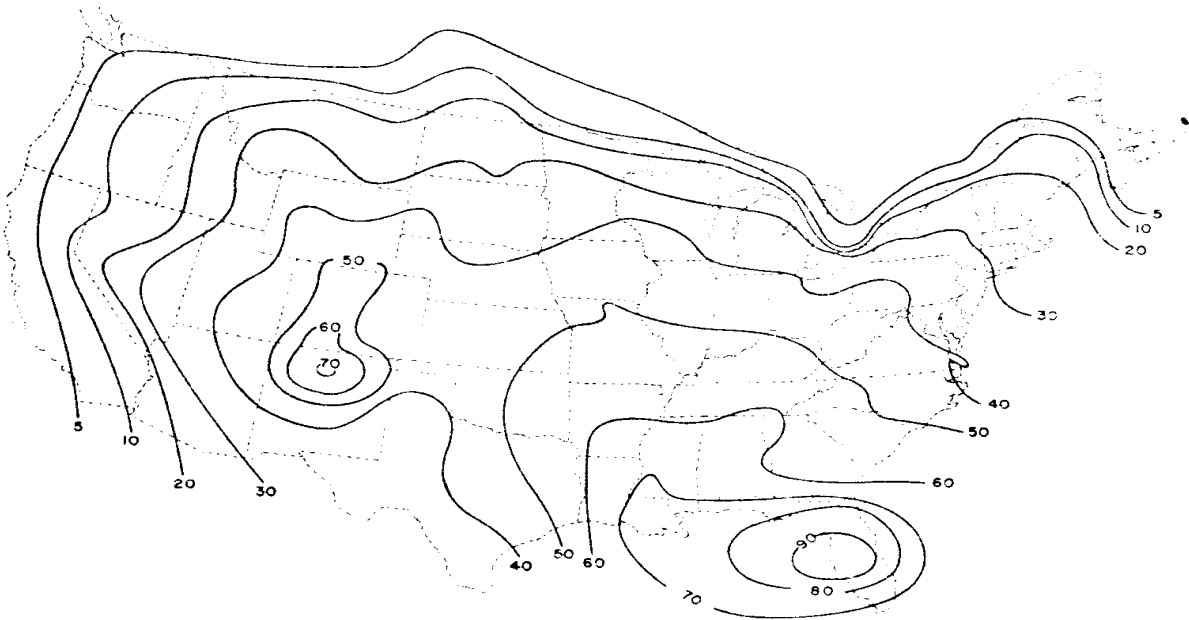

Figure 5-2. Annual isokeraunic map (after Alexander)

In other words, the house in this example can be expected to intercept a lightning strike once every two hundred years. This prediction would be based on a house projecting above flat terrain, which we understand to be the case here. One must bear in mind that in the absence of adjacent, overlapping cones of protection from other buildings, trees or structures, the house and its cones can be treated as completely independent from the surroundings. On the other hand, hill tops and elevated details of the terrain can affect the local isokeraunic level upward, while depressed locations will affect it downward.

A simple trade-off based on economics would then consist in stating that for an estimated repair cost of say, \$ 200 000, and a project life of two years, the break-even value of a lightning protection system is $200\,000 \times 0.005 \times 2 = \2000 . However, this trade-off undoubtedly would be modified to take into consideration the "utility" concept in a game plan. This concept introduces subjective factors which tend to magnify the perceived cost of a failure, but decrease the perceived cost of a desired event. Stated in other terms, a trade-off in this project must also take into consideration intangible factors such as delays in the study and the embarrassing situation of a major failure caused by a single lightning strike.

Therefore we submit that a well designed lightning protection system, at this time divorced from aesthetic considerations, would be a sound investment. This situation may change when the cost of the arrays will be lower, giving greater weight to aesthetics.

6.0 BIBLIOGRAPHY

Cavendish, H., Watson, W., Franklin, B., and Robertson, J.,
"Report of the Committee Appointed by the Royal Society to
Consider a Method of Securing the Powder Magazines at Purfleet,"
Philosophical Transactions of the Royal Society (London, England),
vol. 63, 1773, and vol. 68, 1777.

Walter, B., "Über die Schutzwirkung von Fernblitzableitern und
die Blitzschlaghäufigkeit in einigen Grosstädten," Deutsche
öffentlichrechtliche Versicherung, no. 18, 1935.

Mc Cann, G. D., "The Measurement of Lightning Currents in Direct
Strokes," AIEE Transactions, vol. 63, 1944.

Golde, R. H., "The Frequency of Occurrence and the Distribution of
Lightning Flashes to Transmission Lines," AIEE Transactions, vol.
64, 1945.

Lewis, W. W., The Protection of Transmission Lines Against Lightning.
John Wiley, New York, 1950.

Westinghouse Electric Corp., Electrical Transmission and Distribution
Reference Book, Chapter 16, East Pittsburgh, Pa., 1950.

Hagenguth, J. H. and Anderson, J. G., "Lightning to the Empire State
Building - Part III," AIEE Transactions, vol. 71, Part III (Power
Apparatus and Systems), August 1952.

British Standard Code of Practice CP 326:1965, "The Protection of
Structures Against Lightning," British Standards Institution, British
Standards House, 2 Park Street, London, W.I.

Golde, R. H., "The Lightning Conductor," Journal of the Franklin Institute, vol. 283, No. 6, June 1967.

Berger, K., "Novel Observations of Lightning Discharges: Results of Research on Mount San Salvatore," Journal of the Franklin Institute, vol. 283, No. 6, June 1967.

Blitzschutz, Eighth Edition, VDE-Verlag Gmbh., 1 Berlin 12, Bismarckstrasse 33.

Cianos, N. and Pierce, E. T., "A Ground-Lightning Environment for Engineering Usage," Stanford Research Institute Technical Report 1, August 1972.

Golde, R. H., "Lightning Protection," Edward Arnold Pub., London, 1973.

Lightning Protection Code, 1975, NFPA-78, National Fire Protection Association, 60 Batterymarch St., Boston, Mass. 02110.