

**Proceedings  
of the  
Workshop on Future Large  
CO<sub>2</sub> Compression Systems**

**March 30-31, 2009  
National Institute of Standards and Technology  
Gaithersburg, MD**

**Sponsored by**

**DOE Office of Clean Energy Systems  
National Institute of Standards and Technology  
EPRI**

**Prepared By**

**Ronald H. Wolk  
Wolk Integrated Technical Services  
San Jose, CA**

**July 30, 2009**

**DISCLAIMER OF WARRANTIES AND  
LIMITATIONS OF LIABILITIES**

**This report was prepared by Wolk Integrated Technical Services (WITS) as an account of work sponsored by Pacific Northwest Laboratories**

**WITS: a) makes no warranty or representation whatsoever, express or implied, with respect to the use of any information disclosed in this report or that such use does not infringe or interfere with privately owned rights including any party's intellectual property and b) assumes no responsibility for any damages or other liability whatsoever from your selection or use of this report or any information disclosed in this report.**

**Table of Contents**  
**Title**

<b>Section</b>	<b>Title</b>	<b>Page</b>
1	Summary	1
2	Overview of Technical Presentations	
	A. Sources of CO <sub>2</sub> in the US	4
	B. CO <sub>2</sub> Capture Technology	5
	C. CO <sub>2</sub> Pipelines	7
	D. Delivered Cost of CO <sub>2</sub>	8
	E. Challenges of CO <sub>2</sub> Transportation	8
	F. Properties of CO <sub>2</sub> and Co-constituents Near the CO <sub>2</sub> Critical Point	9
	G. Compression Systems Machinery	11
	H. Electric Drive Machinery	14
	I. Drive Electronics and Components	16
3	Prioritization of Potential R&D Projects	19
4	List of Workshop Presentations	27
5	Appendices	
	A. Workshop Agenda	28
	B. List of Workshop Participants	31

## List of Abbreviations

3D	three dimensional
A	amperes
AC	Alternating Current
acfm	actual cubic feet per minute
API	American Petroleum Institute
Bar	metric unit of pressure, approximately 14.5 psi
Bara	bar, absolute
bcf	billion cubic feet
C	Centigrade
CCS	Carbon Capture and Sequestration
CTE	Coefficient of Thermal Expansion
ERDC-CERL	US Army Engineer Research and Development Center, Construction Engineering Research Lab
EPRI	Electric Power Research Institute
d	day
DC	Direct Current
DMOSFET	Double Diffused (or Implanted) Metal-Oxide-Semiconductor Field Effect Transistor
DOD	Department of Defense
DOE	Department of Energy
EOR	
EOS	Equation of State
F	Fahrenheit
FC	Fuel Cell
GW	Gigawatt
Gt	Giga-tonnes
GTO	Gate Turn-Off Thyristor
HANS	HANS equation of state
HF	High Frequency
Hz	Hertz
hr	hour
HVDC	High Voltage Direct Current
HV	High Voltage
IEA	International Energy Agency
IGBT	Insulated Gate Bipolar Transistor
IGCT	Integrated Gate Commutated Thyristor
kA	kilo-amperes
kHz	kilohertz
km	kilometer
kV	kilovolt
kVA	kilovolt ampere
kW	kilowatt
kWh	kilowatt hour
lbm/hr	pound moles/hour

LCI	Line Commutated Inverter
LMTD	Log Mean Temperature Difference
LNG	Liquefied Natural Gas
MEA	Monoethanolamine
MERGE	Model for Evaluating the Regional and Global Effects of GHG Reduction Policies
M/G	Motor/Generator
MM	million
MMSCFD	million standard cubic feet per day
MSCF	thousand standard cubic feet
MOSFET	Metal-Oxide-Semiconductor Field Effect Transistor
mt	metric tonnes
mt/yr	metric tonnes per year
MVA	Megavolt Ampere
MW	Megawatt electric
MWt	Megawatt thermal
NIST	National Institute of Standards and Technology
Nm <sup>3</sup>	Normal cubic meters
PCS	Power Conditioning System
psia	pounds per square inch absolute
PVT	Pressure Volume Temperature
ppm	parts per million
R&D	Research and Development
RKS	Redlich-Kwong-Soave equation of state
rpm	revolutions per minute
SwRI	Southwest Research Institute
tpd	tons/day
V	volts
VLE	Vapor Liquid Equilibria

# 1. Summary

A Workshop on Future Large CO<sub>2</sub> Compression Systems was held on March 30-31, 2009 at NIST headquarters in Gaithersburg, MD. Such systems could be utilized as part of the equipment needed to transport CO<sub>2</sub> captured at fossil fuel power plants by pipeline to permanent sequestration sites and/or for sequestration well injection. Seventy-seven people who are active in this field participated. The Organizing Committee for the Workshop consisted of Dr. Allen Hefner of NIST, Dr. Robert Steele of EPRI, Dr. Peter Rozelle of DOE and Ronald H. Wolk of Wolk Integrated Technical Services.

The objective of this Workshop was to identify and prioritize R&D projects that could support development of more efficient and lower cost CO<sub>2</sub> compression systems. Reducing the total cost of Carbon Capture and Sequestration is a major goal of R&D programs sponsored by organizations including US DOE, IEA, EPRI, MERGE and others. The capital cost of compression equipment and the associated cost for compression energy are major components of this total cost.

Twenty technical presentations were given to familiarize Workshop participants with a broad spectrum of multiple aspects of the technologies involved including:

- Future Market Drivers for CO<sub>2</sub> Compression Equipment
- Characteristics of Large Power Plants Equipped for CO<sub>2</sub> Capture and Compression
- Oil and Gas Industry Experience with CO<sub>2</sub> Capture, Compressors and Pipelines
- Compressor Vendor Perspective on Changes in Compression Cycle Machinery
- Electric Drive Compressor Potential for Improvement in Capital Cost, Power Requirements, Availability, and Safety
- Advanced Compressor Machinery Future R&D Needs
- Advanced Electric Drive Compressor Future R&D Needs

The presentations are available at [www.nist.gov/eeel/high\\_megawatt/2009\\_workshop.cfm](http://www.nist.gov/eeel/high_megawatt/2009_workshop.cfm)

The key points that can be summarized from these presentations are that:

- Existing commercial CO<sub>2</sub> pipelines in the United States, with a total length of about 5650 km (3500 miles), operate safely
- These pipelines are utilized primarily to deliver about 68,000 mt/day (75,000 tons/day) of pressurized CO<sub>2</sub>, recovered from both natural reservoirs and from natural gas purification and chemical plants to existing Enhanced Oil Recovery projects.
- A typical 550 MW coal-fired power plant will produce about 13,500 mt/day (15,000 tons/day) of CO<sub>2</sub>. A large number of coal-fired power plants of this size are likely to be built between now and 2030 to meet the increased demand for power in the US. According to the EIA *AEO2009* reference case, total electricity generation from coal-fired power plants will increase from 1906 billion kWh in 2009 to 2236 billion kWh in 2030. The current capacity of coal fired generating plants in the US is about 311,000 MW.

- The accuracy of the Equations of State used to predict the properties of the CO<sub>2</sub> recovered from the flue gas produced by coal-fired power plants, which includes a wide variety of contaminants, needs to be improved to reduce typical design margins used by compressor vendors.
- Reciprocating and centrifugal compressors are available from a variety of vendors to meet the pressure and volumetric flow requirements of all applications. The largest machines pressurize about 18,000 mt/day (20,000 tons/day) to 27,000 mt/day (30,000 tons/day) of CO<sub>2</sub> to the pressures required for pipeline transportation or sequestration well injection.
- Power required for compression could be reduced if CO<sub>2</sub> was first compressed to an intermediate pressure, then cooled and liquefied, and that liquid is then pumped to the higher pressure level required for pipeline injection.
- Improved materials are needed to allow higher speed rotor operation and corrosion resistance of rotors and stators.
- Competitively priced commercially available power conditioning components and modules are needed that will allow systems to operate at >10 kV and switch at >10 kHz
- SiC-based power conditioning and control components to replace existing Si-based components can lead to higher efficiency electric drive systems.

After digesting the information presented, the Workshop participants suggested a total of 33 R&D projects in seven categories. Thirty-seven of the Workshop attendees then participated in a Prioritization Exercise that allocated 3700 votes (100 by each of those participants) among the seven categories of R&D activities and 33 specific R&D projects.

The results of the Prioritization Exercise are presented in Tables 1 and 2. Table 1 lists the rank order by total votes of the seven Categories. Table 2 lists the top 10 projects, out of a total of 33, by rank order of total votes.

**Table 1. Rank Order of R&D Categories**

<b>R&amp;D Categories</b>	<b>Total Votes</b>
1. Properties of CO <sub>2</sub> and Co-constituents	914
2. Integration of CO <sub>2</sub> Capture and Compression	726
3. Compression Systems Machinery and Components	690
4. Electric Drive Machinery	545
5. Pipeline Issues	456
6. Drive Electronics and Components	326
7. Impacts of Legislation on CCS	43

**Table 2. Rank Order of Top 10 R&D Projects**

<b>R&amp;D Project</b>	<b>Total Votes</b>
1. Perform more gas properties measurements of CO <sub>2</sub> mixtures	435
2. Improve Equations of State	401
3. Optimize integration of a CO <sub>2</sub> capture/compression system together with the power plant	280
4. Comparison and evaluation of compression-liquefaction and pumping options and configurations	204
5. Higher voltage, higher power, and speed electric motors and drives	165
6. Install test coupons in existing CO <sub>2</sub> pipelines to obtain corrosion data, then develop CO <sub>2</sub> product specifications	150
7. Determine optimal electric motor and drive types, speeds, and needed voltages, etc., for CO <sub>2</sub> compressors	143
8. Establish allowable levels of contaminants in CO <sub>2</sub> pipelines and/or compressors	120
9. Compressor heat exchanger data for power plant applications including supercritical fluids	117
10. Integrate utilization of waste heat to improve cycle efficiency	113



## 2. Overview of Technical Presentations

This section of the report organizes a fraction of the total information presented at the Workshop into brief summaries. Readers are strongly encouraged to review the actual presentation materials for those topics about which they need additional information.

### A. Sources of CO<sub>2</sub> in the US

CO<sub>2</sub> is recovered commercially from a variety of sources including natural sealed reservoirs typically referred to as domes, and industrial plants. High purity (>95%) CO<sub>2</sub> gas streams are available from processing plants that purify raw natural gas to meet standards for pipeline transmission, and from chemical plants that gasify coal or produce hydrogen, ammonia, and other fertilizers, and potentially from future gasified coal power plants. These operations are the preferred man-made sources of CO<sub>2</sub> because the gas from those plants is available at high pressure. Other sources of CO<sub>2</sub> are available at lower pressures at high purity (from fermentation plants producing ethanol) and at low purity (from pulverized coal power plants and cement plants). The locations of various commercially utilized sources of CO<sub>2</sub> are listed below and are also shown in Figure 2.1 (Kubek)

- Natural CO<sub>2</sub> Reservoirs
  - Bravo Dome (TX)
  - Jackson Dome (MS)
  - McElmo Dome (CO)
  - Sheep Mountain Dome (CO)
- Natural Gas Purification Plants
  - LaBarge Gas Plant (WY)
  - Mitchell Gas Plant (TX)
  - Puckett Gas Plant (TX)
  - Terrell Gas Plant (TX)
- Solid Fuel Gasification Plant
  - Great Plains Coal Gasification Plant (ND) – fueled with North Dakota lignite (2.7 million tons CO<sub>2</sub> per year)
  - Coffeerville Resources Plant (KS) – fueled with Coffeerville refinery petroleum coke
- Industrial Chemical Plants
  - Ammonia Plant (OK)

Low purity CO<sub>2</sub> containing streams are produced by coal-fired power plants (12-15%), cement plants (12-15%), and natural gas fired gas turbine/combined cycle power plants (3-4%). These are not used as sources for large scale CO<sub>2</sub> recovery. (Schoff)

Much of the CO<sub>2</sub> that is separated in natural gas purification systems is not utilized commercially but is disposed of by venting to the atmosphere, or if contaminated with H<sub>2</sub>S, is injected into saline aquifers through deep injection wells. Over 50 acid gas (CO<sub>2</sub> + H<sub>2</sub>S) injection projects for acid gas disposal are currently operating in North America. In most cases

the acid gases consist primarily of H<sub>2</sub>S but all streams contain CO<sub>2</sub>. Injection rates range from < 0.0268 MM Nm<sup>3</sup> (<1 MMSCFD) to 0.48 MM Nm<sup>3</sup> (18 MMSCFD) in Canada. The ExxonMobil LaBarge Gas Plant in Wyoming injects about 2.4 MM Nm<sup>3</sup> (90 MMSCFD). Major process components after the Acid Gas Removal plant are either compression with integrated partial dehydration or compression and standard dehydration. Various conceptual projects are in the design stages in the Middle East for acid gas injection rates that will exceed 10.7 MM Nm<sup>3</sup> /day (400 MMSCFD). (Maddocks)

Existing acid gas injection plants typically use reciprocating compressors. Larger volume conceptual projects, for larger volume applications in the Middle East, are being designed with centrifugal compressors. Injection pressures can range from 34.5 bar (500 psi) to over 207 bar (3000 psi) depending upon the depth and permeability of the formation. Depleted reservoirs or deep aquifers are typically utilized. These “relatively” small projects can be designed and operated safely with existing technology. (Maddocks)



**Figure 2.1 Location of CO<sub>2</sub> Sources and Pipelines in the US**

## **B. CO<sub>2</sub> Capture Technology**

CO<sub>2</sub> is typically captured from a process plant gas stream by contacting the stream with an appropriate solvent. The choice of solvent depends primarily on the pressure of that gas, its CO<sub>2</sub>

content, and the levels and types of contaminants contained in that gas. Low pressure (near atmospheric pressure) gas streams are typically treated with amine-based solvents that remove the CO<sub>2</sub> by chemical reaction. High pressure gas streams (>3.6 bar (50 psi)) are typically treated with solvents that capture CO<sub>2</sub> by physical absorption. Solvent regeneration to break the chemical bonds between the amine and CO<sub>2</sub> is done by the use of heat, typically recovered from other plant process streams. CO<sub>2</sub> is typically removed from the physical solvents by pressure reduction.

There are three relatively low capacity plants currently operating in the US that use monoethanolamine (MEA) solvent to capture CO<sub>2</sub> for local uses including freezing chickens, carbonating soda pop, and manufacturing baking soda, at a cost of ~\$140/ton CO<sub>2</sub>. The total amount of CO<sub>2</sub> recovered in these plants is about 270 MT/day (300 tons/day). This is equivalent to the emissions from a very small (~15 MW) power plant.

Coal gasification plants that produce hydrogen, ammonia, and other fertilizers typically use physical solvents to remove CO<sub>2</sub> and H<sub>2</sub>S from product gases. Most of these plants are located in China and South Africa. Some plants of this type operate in the US.

Oxyfuel is a combustion process under development at a number of locations. It combusts fuel with oxygen which is diluted with captured and recycled CO<sub>2</sub>. There are several contaminants that must be controlled to specific levels including O<sub>2</sub>, N<sub>2</sub>, Ar, SO<sub>2</sub>, and H<sub>2</sub>O, to avoid problems with the CO<sub>2</sub> capture system. (Schoff). The largest Oxyfuel development facility is a 50 MWt natural gas fired demonstration plant that is being planned for installation at the Kimberlina Power Plant near Bakersfield, CA. Other test facilities include a number of smaller coal-fired facilities including the B&W 30-MWt test facility in Ohio, a 30-MWt pilot plant under construction by Vattenfall, and several operating pilot-scale (~1 MWt) test units. (Schoff, Hustad)

Other technologies for CO<sub>2</sub> capture are under development. Many pilot plant projects are planned and in development, including those that use chilled ammonia as a solvent. (Schoff)

One CCS demonstration now under way in the North Sea off the Norwegian coast is the Sleipner CO<sub>2</sub> Injection Project. It is located on a drilling platform and utilizes an amine system to capture 1 million mt/y (1.1 million/tons/y) of CO<sub>2</sub> that is then injected into a deep saline aquifer at 65 bar (840 psi). The objective of the project is to reduce the CO<sub>2</sub> content of raw natural gas from 9 % to 2.5 % to meet commercial sale specifications. The test program has been in operation since 1996 with a reliability level of 98-99%. (Miller)

The costs of CO<sub>2</sub> capture from natural gas fired and coal fired power plants (IGCC plants and Oxyfuel plants) followed by pressurization to 150 bar (2200 psi) as reported at the Workshop by two authors are shown in Table 2.1.

**Table 2-1 Cost of CO<sub>2</sub> Capture**

<b>Author</b>	<b>Hattenbach</b>	<b>Amick</b>
	<b>\$/metric ton</b>	<b>\$/metric ton</b>
<b>Natural Gas Combined Cycle</b>	83	
<b>Supercritical Pulverized Coal</b>	67-68	40
<b>IGCC</b>	39	20
<b>Oxyfuel (new)</b>	48	
<b>Oxyfuel (retrofit)</b>	67	
<b>Coal to Liquids</b>		10
<b>Synthetic Natural Gas</b>		8

### **C. CO<sub>2</sub> Pipelines**

As shown in Figure 2.1, existing networks of pipelines move CO<sub>2</sub> from sources to markets. The purity of the CO<sub>2</sub> used for EOR is >95 %. (Hattenbach) At this time, the major markets for CO<sub>2</sub> are for Enhanced Oil Recovery (EOR) in the Permian Basin of Texas and New Mexico, the Gulf Coast, and the Weyburn fields in Saskatchewan, Canada. EOR operations in the Permian Basin utilize 0.043 bNm<sup>3</sup>/d (1.6 bcf/d) of CO<sub>2</sub> to recover ~180,000 barrels per day (B/D) of incremental oil, which represents ~70 % of global CO<sub>2</sub>-EOR production. (Hustad) In the U.S., a limited number of locations in Kansas, Mississippi, Wyoming, Oklahoma, Colorado, Utah, Montana, Alaska, and Pennsylvania also utilize CO<sub>2</sub> injection to increase oil recovery. (Hattenbach, Kuuskraa).

The first CO<sub>2</sub> pipeline in the US was constructed in 1974. All of these pipelines utilize the same type of carbon steel pipe that is used for natural gas pipelines. These systems operate routinely without any significant or safety issues. Corrosion of carbon steel has been successfully avoided by maintaining the water content of the CO<sub>2</sub> at very low levels to avoid formation of carbonic acid, which attacks carbon steel. (Kadnar)

- CO<sub>2</sub> pipelines are protected from damage by the following procedures:
  - 24 hour monitoring by a Control Center
  - Membership in statewide one-call networks
  - Compliance with Common Ground Alliance Best Practices
  - Patrolled by air 26 times per year
- CO<sub>2</sub> pipelines are protected from corrosion by:
  - Annual pipe to soil survey of pipeline
  - Five year cycle of Close Interval Surveys
  - Assessments of High Consequence Areas under Pipeline Integrity Management program (Kruuskaa)

Based on the assumed use of about 0.3 mt (0.33 tons) of CO<sub>2</sub> /barrel of oil produced and production of about 250,000 B/D of oil by using CO<sub>2</sub> injection (Kuuskraa), the total amount of CO<sub>2</sub> carried by all the CO<sub>2</sub> pipelines in the US is estimated at about 67,000 mt/day (75,000 tons/day). To put that number in perspective relative to the potential markets for CO<sub>2</sub> capture for

CCS purposes, a single 550 MW coal-fired power plant produces about 15,000 tons/day of CO<sub>2</sub>. (Schoff) Currently, US emissions of CO<sub>2</sub> resulting from coal combustion amount to about 2100 MMT/y (2300 million tons per year) or about 5.7 million mt/day (6.3 million tons/day, equivalent to 400 coal-fired power plants, each with a capacity of 550 MW).

The costs of new CO<sub>2</sub> pipelines have been estimated as follows:

100 miles of 24" pipe line with a capacity of (500 MMSCFD)

- |   |                 |
|---|-----------------|
| • Flat Dry Land   | \$120,000,000   |
| • Mountains   | \$204,000,000   |
| • High Populated Urban  | \$250,000,000   |
| • Offshore with a water depth of 46 m (150 ft.) – 61 m (200 ft)<br>(Kuuskraa) | \$1,680,000,000 |

IEA has proposed a combination of several approaches to stabilize the CO<sub>2</sub> concentration in the atmosphere at 450 ppm by 2030. These include an annual reduction of CO<sub>2</sub> emissions by 2.3 Gt/year by means of CCS. This would imply that the future amount of captured CO<sub>2</sub> will be about the same as today's natural gas production.

Twelve full-scale CCS projects are in the planning stage for Europe by 2012. These early projects will have individual pipelines. Interconnections among early projects are anticipated in 2015-2025. Looping of these pipelines is anticipated in 2025-2035 to create a CO<sub>2</sub> pipeline ring similar to that now exists in Texas to serve the Permian Basin EOR market. (Bratfos)

#### **D. Delivered Cost of CO<sub>2</sub>**

CO<sub>2</sub> obtained from natural sources is now delivered commercially by pipeline to EOR sites at a price of about \$1.25/MSCF (\$24/metric ton, \$22/ton). In comparison, the cost to compress and transport for 50 miles about 1.34 MM Nm<sup>3</sup> (50 MMSCF/d) of CO<sub>2</sub> recovered from high purity (>95%) man-made sources (natural gas processing plants, hydrogen production plants, etc.) will cost from \$1.30 to \$1.75/ MSCF or \$25.50/mt (\$23/ton) to \$33.70/mt (\$30/ton). The cost of compressing and transporting a similar amount of CO<sub>2</sub> recovered from low purity (<15%) sources a similar distance would range from \$2.85 to \$4.00/MSCF or from \$55.00/mt (\$50/ton) to \$77.00/mt (\$70/ton). Of that total, the cost of capture is much higher than that of compression. Significant reductions are needed in both capture and compression cost for man-made sources of CO<sub>2</sub> to compete with natural sources for EOR markets. (Hattenbach)

#### **E. Challenges of CO<sub>2</sub> Transportation**

The development of a national pipeline network equal in scope to the present natural gas pipeline network is a challenging task. An alternate approach is to focus on regional sequestration sites, and be proactive about siting issues so that new plants will be near sequestration sites. The use of CO<sub>2</sub> for EOR is mature and the liability issues have been resolved. DOE cost goals for CO<sub>2</sub>

sequestration are very aggressive relative to currently estimated costs of capture and transportation. (Hattenbach)

For non-EOR sequestration to be commercially attractive, US industry needs visibility on:

- Value of emission reduction credit
- Regulations – Federal and State
  - Early action might be penalized
  - Economic - benefit or cost?
- Pore space ownership
- Liability issues
- Cost for capture and compression of man-made CO<sub>2</sub> needs to be decreased (Hattenbach)

There are a number of concerns related to large scale CO<sub>2</sub> transmission by pipeline:

- **Root causes**
  - Emergency blowdown of large dense phase inventories
  - Accidental denting
  - CO<sub>2</sub> corrosion leaks in case of accidental intake of water
  - Material compatibility (elastomers, polymers)
  - Ductile fracture of pipeline (“un-zipping”)
- **Consequences**
  - Dispersion of concentrated CO<sub>2</sub>
  - Dispersion of toxic impurities
  - Pipeline damage/downtime

(Bratfos)

## **F. Properties of CO<sub>2</sub> and Co-constituents Near the CO<sub>2</sub> Critical Point**

One of the conclusions reached by participants of the Workshop was that the use of currently available versions of the Equations of State (EOS) to predict the properties of supercritical CO<sub>2</sub> which is contaminated with other compounds (i.e. A, N<sub>2</sub>, O<sub>2</sub>, CO, NH<sub>3</sub>, H<sub>2</sub>S,) at conditions near the critical point are not reliable enough for precise compression system designs. Several of the presentations commented on this issue as follows.

“GE has used the BWRS (Benedict-Webb-Rubin-Starling) EOS for the last 30 years: up to 300 bar on regular basis and up to 540 bar with CO<sub>2</sub> + HC gas mixture in specific cases .... also in the supercritical region. BWRS above 480 bar requires careful verification of literature data and is not suitable for liquid-vapor equilibrium calculations. Many existing CO<sub>2</sub> EOS are optimized for pure CO<sub>2</sub> but not for mixtures. To allow for regions not adequately covered by current EOS, GE is introducing a new thermodynamic model to improve predictability.” (Minotti)

“Better understanding of Phase behavior and confidence in EOS predictions” is needed.”(Maddocks)

“Equations of state near critical point... theories vary at high pressure also with co-constituents”. (Miller)

“Compressibility is an issue at high pressure to stay away from liquid phase.” (Kisor)

“Equation of state models for CO<sub>2</sub> based mixtures have not been fully developed or validated. Large differences (19% variation) exist in gas properties predicted by standard equation of state models (API, RKS, HANS) and pure CO<sub>2</sub> correlation models from 1000-2000 psia. EOS fall short on density and speed of sound especially with NIST supertrack program – is it applicable? “The needed actions are to perform more gas properties measurements of CO<sub>2</sub> mixtures and refine equation of state near critical point and with mixtures.” (Moore)

”Equations of state are not good enough when we have water condensing out. Small amounts of impurities in CO<sub>2</sub> change the location of the supercritical line. Better [pressure, volume, temperature] PVT data are needed on mixtures of CO<sub>2</sub> and other gases.” (Hustad)

As a result of the deficiencies in the available data, larger margins than may be necessary are used by designers and manufacturers in their products. Better EOS have the potential to be used to lower equipment costs. As one illustration of the differences, Figure 2-2 (Moore) shows the variation in predicted density of CO<sub>2</sub> obtained with various prediction methodologies.

Figure 2-2

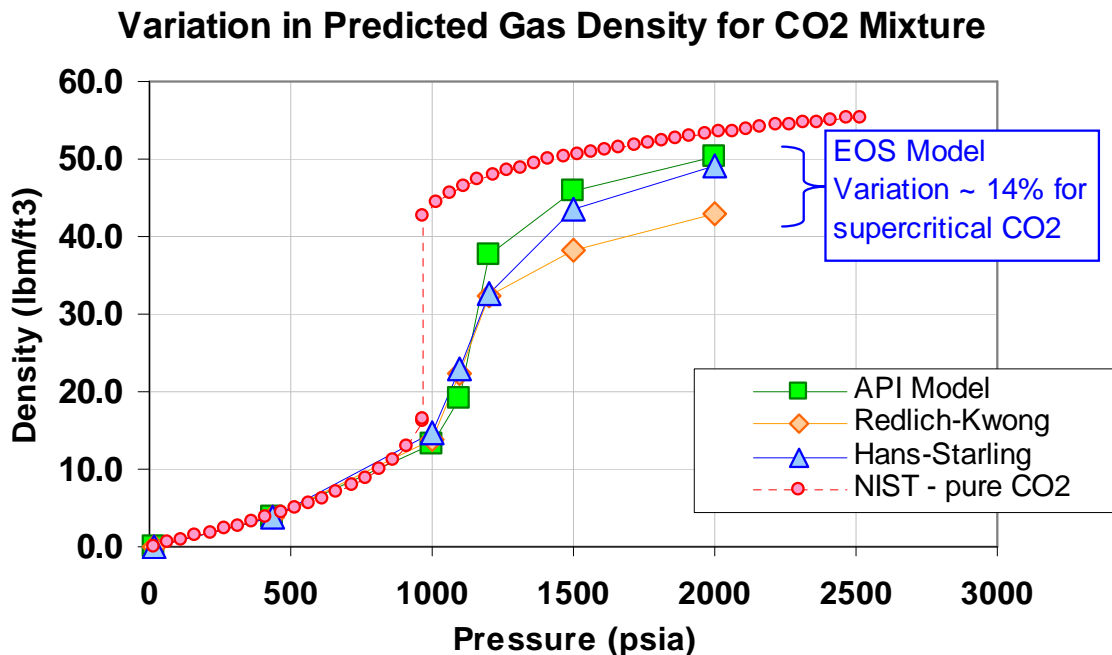

## **G. Compression Systems Machinery**

### **1. Existing Compression System Machinery**

Most of the large scale industrial experience with CO<sub>2</sub> compression has been with CO<sub>2</sub>+H<sub>2</sub>S re-injection, fertilizer and hydrogen manufacturing, and CO<sub>2</sub> pipelines. (Miller, Minotti, and Kisor) Reliability experience ranks centrifugal compressors highest, followed by integrally geared, and then reciprocating units. (Minotti) GE has recently utilized supercritical compression (6 stages) to reach liquefaction conditions, followed by centrifugal pumping to enable pumping the supercritical fluid to the final required pressure. (Minotti) Integrally geared machines achieve near-isothermal compression, which saves energy, but those machines have many more moving parts compared to reciprocating and centrifugal compressors. MAN Turbo compressors are used to pressurize CO<sub>2</sub> at the Great Plains Coal Gasification plant in Beulah, ND for transmission by pipeline to the Weyburn oil fields in Saskatchewan, Canada a distance of more than 325 km. (200 miles).

CO<sub>2</sub> compression requires a significant amount of energy to achieve a final pressure of 103 bara (1,500 psia) to 152 bara (2,200 psia) for pipeline transport or re-injection. For a typical 400 MW coal-fired plant, the typical CO<sub>2</sub> flow rate is 120 mt/hr (132 tons/hr) to 140 mt/hr (154 tons/hr). The type of compressor selected is highly dependent on the starting pressure, which is approximately 1.3 bar (20 psia) to 34.5 bara (500 psia) for CO<sub>2</sub> scrubbing of the fuel stream from an IGCC plant and approximately one bara (14.5 psia) from conventional pulverized coal power and Oxy-Fuel process power plants. Various types of compressors including ordinary and integrally geared centrifugal and reciprocating machines have been utilized to meet these compression service requirements depending on inlet and outlet pressures and volumetric flows. Reciprocating compressors are capable of achieving higher final pressures than centrifugal compressors, while centrifugal compressors can handle higher flow rates. For the large quantities of CO<sub>2</sub> that must be handled in CCS applications, large capacity, single compression trains offer a significant cost advantage. (Moore)

Many vendors market the compressors that could be used in CO<sub>2</sub> compression service for CCS projects. Dresser Rand, GE, and MAN Turbo, which are representative of vendors that produced very large compressors were invited to present information on their typical products. Participants in the Workshop included representatives of other compressor vendors and technology developers including ABB, Curtiss-Wright, Elliott, Florida Turbine Technologies, Mitsubishi Heavy Industries, Solar Turbines, Turbplex, and others.

The compressor data presented by Dresser-Rand, GE and MAN Turbo is summarized in Table 2-2.



**Table 2.2 – Representative Large Compressor Data**

<b>Vendor</b>	<b>Dresser Rand</b>	<b>GE</b>	<b>MAN Turbo</b>
<b>Reference</b>	<b>Miller</b>	<b>Minotti</b>	<b>Kisor</b>
<b>Compressor type</b>	<b>Reciprocating, Centrifugal</b>	<b>Centrifugal</b>	<b>Integrally Geared Centrifugal</b>
<b>Centrifugal Compressors in service/ total power</b>	105/ ~300 MW total	200+/up to 18 MW for largest unit	
<b>Maximum Discharge Pressure</b>	Centrifugal 178 bar (2,580 psia) operating 309 bar (4,472 psia) to be delivered in late 2009	280 bara	225 bar
<b>Maximum inlet flow</b>	82,100 m <sup>3</sup> /hr (48,300 acfm)	300,000 Nm <sup>3</sup> /hr (176,500 acfm)	350,000 Nm <sup>3</sup> /hr (205,800 acfm)
<b>Reciprocating Compressors in service/ total power demand</b>	227 units/  >395MW	180+/  	
<b>Maximum Discharge Pressure</b>	426 bara (6,213 psia)	750 bara	
<b>Maximum inlet flow</b>	7,300 m <sup>3</sup> /hr (4,300 acfm)	19,000 Nm <sup>3</sup> /hr (11,300 acfm)	

Design issues for CO<sub>2</sub> compressors include carbonic acid corrosion of carbon steel if water is present in the system. The use of stainless steel for any components in contact with wet CO<sub>2</sub> eliminates the problem. Similarly, the presence of water containing CO creates iron carbonyl upon contact with carbon steel. Again, the use of stainless steels solves the problem. Special O-ring materials are required to resist explosive decompression due to entrapped CO<sub>2</sub> within the O-rings. (Miller)

Aerodynamic challenges include very high pressure ratio and compressibility and a wide range of flow coefficient stages. Additional challenges relative to rotor dynamics are the very high density of CO<sub>2</sub> and destabilizing effects and predictability of compressor seal dynamic coefficients. (Minotti)

Integrally geared compressors can be optimized for each stage due to lower volume and higher pressure at each progressive stage. This attribute provides the ability to spin high pressure impellers at higher speed. It is possible to go to different speeds on each pinion and stage so that very high (50,000) rpm are possible. The polytropic efficiency of these machines is in the high eighties. As a result of the potential to form liquid phases at high pressures, the final compression

stages are not intercooled, so that the temperature is always maintained above the critical point to stay in gas regions. (Kisor)

A sketch of a recent design of a MAN Turbo integrally geared compressor is shown in Figure 2-3.

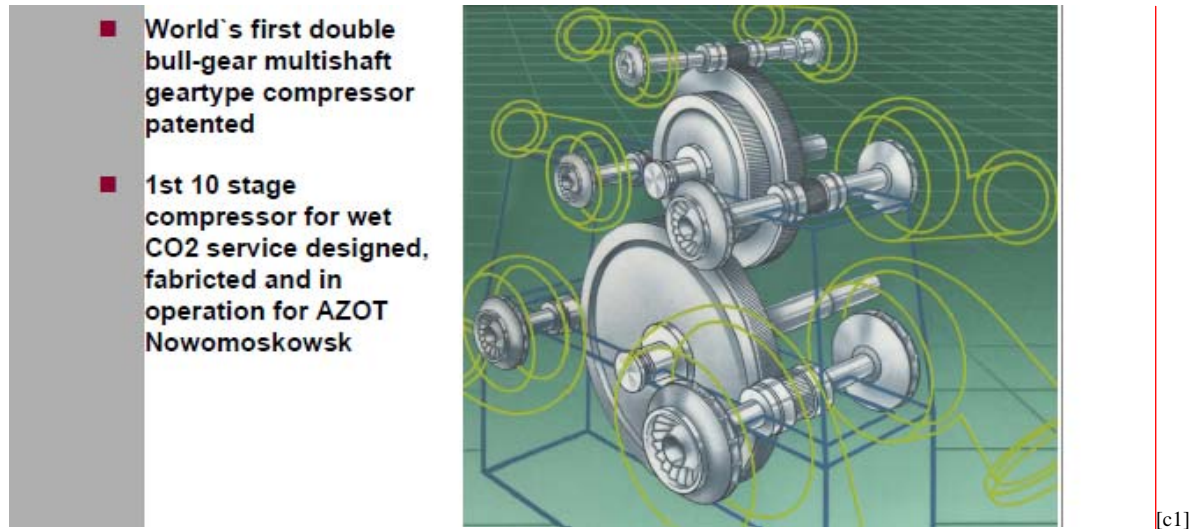

**Figure 2.3 MAN Turbo Integrally Geared Compressor**

## **2. R&D to Support Future Advancements in Compression Systems Machinery**

### **Interstage Cooling/Liquefaction/Cryogenic Pumping**

The high pressure ratios required in each turbine stage to ultimately reach the high total pressures required by CCS systems results in a significant amount of heat of compression. Compression systems must also be integrated with both the power production and CO<sub>2</sub> capture plants to optimize heat integration. DOE-supported studies by SwRI, working with Dresser-Rand, have demonstrated that an isothermal compressor combined with cryogenic pumping offers the potential to significantly reduce compression power requirements by 20-35%. The goal of this R&D program is to develop an internally cooled compressor stage and qualify a liquid CO<sub>2</sub> pump for CCS service

The focus of the internally cooled compressor stage program is to:

- Provide performance equivalent to an integrally geared compressor
- Achieve the high reliability of an in-line centrifugal compressor
- Reduce the overall footprint of the package
- Have less pressure drop than an external intercooler

The CO<sub>2</sub> liquefaction process that SwRI has identified as being very promising in terms of reducing compression requirements significantly follows the steps listed below:

- Utilizes a refrigeration system to condense CO<sub>2</sub> at about 17.2 bar (250 psia) and -20°C (-36°F).
- Liquid is then pumped from 17.2 bara (250 psia) to 153 bara (2,215 psi).
- Significantly less power is required to pump liquid compared to compressing a gas.
- The cost of the refrigeration system must be accounted for. (Moore)

GE is now using supercritical compression (4 stages) and centrifugal pumps and refrigeration at -20 °C (-36 °F) to reduce power requirements by about 25 % in one specific application. (Minotti)

## **Advanced Compressors**

Ramgen is developing an advanced compressor for CCS applications with the following:

- 100:1 CO<sub>2</sub> compressor 2-casings/2-stages/intercooled
  - No aero Mach # limit
  - 10+:1 pressure ratio; 400°F temperature rise
  - 1400 fps tip speeds; Shrouded rotor design
- Single-stage, discrete-drive
  - Single stage per drive optimizes specific speed match
- “Compressor” heat exchanger cost can be eliminated
  - Eliminate or substantially reduce cooling tower requirement
  - Eliminate or substantially reduce cooling tower make-up water
  - 3x LMTD heat exchangers with 1/3 the surface area

The claimed attributes of this approach are:

- 1/10th the physical size – facilitate space constrained retrofits
- 1/2 the installation cost
- Reduce CCS cost by 56 % from \$64 to \$28/tonne CO<sub>2</sub> (Baldwin)

Dresser-Rand has recently begun supporting this program. (Miller)

## **H. Electric Drive Machinery**

### **1. Existing Electric Drive Machinery**

The oil and gas industry is following the world-wide trend to increased electrification with a diverse range of applications for high power electric drives which require:

- High reliability/availability/maintainability
- High power
- High voltage
- High speed

- Ability to operate in harsh environments  
(Zhang)

A variety of high megawatt direct electric drives are currently available for exploration, production, transport, and processing applications. However, further improvements in capabilities are needed to serve the market for remote sub-sea power located more than 100 miles off-shore in water with depths greater than 200 feet.

The relationship among speed and power rating for various segments of the electric drive market is shown in Figure 2.4.

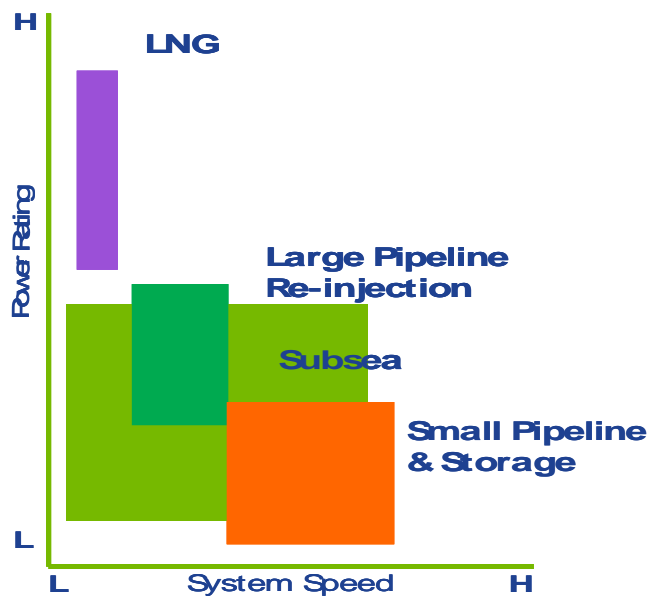

**Figure 2.4 Market Segments for Large Electric Drives (Zhang)**

Among the requirements for this equipment are low ripple currents and low harmonics. GE is offering an integrated high speed motor/generator to the oil and gas markets with drive power needs of up to 15 MW. High speed, high power, direct drive systems eliminate the need for a gear box, which improves reliability.

Recent achievements reported by GE include:

- Replacement of LCI with ICGT drive systems reduces torque ripple by a factor of 3
- Move to high frequency integrated M/G operating at 11,000-17,000 rpm
- 35 MW output at 100 Hz with multi-thread parallel and interleaving control system design

High efficiency synchronous motors are an important approach to minimum total lifecycle costs for drive machinery, since the cost of the electricity used represents 74 % of total lifetime cost for these systems. 4-6 pole synchronous motors offered by ABB in the range of 10-60 MW feature high efficiency, low inrush current and variable power factor. (Kullinger)

Converteam offers Variable Motor Drive Systems in two power ranges, 2-32 MW and 10-100 MW. The lower power system, which uses MV- IGBT press pack technology, can be used with high speed motors, induction motors, and synchronous motors. The higher power system, which uses LCI – Thyristor technology, can be used with both synchronous motors and high speed synchronous motors. (Moran)

## **2. R&D to Support Future Advancements in Electric Drive Machinery**

The market requirements for electric drive machinery are focused on the needs to operate at higher power ratings with even greater reliability and efficiency than today's product offerings. The key to meeting these market demands lies in the realm of technology development that will allow commercial products to operate reliably at voltages above 10 kVA and frequencies above 10 kHz.

Drive component R&D needs include:

- Advanced stator and rotor cooling schemes
- Improved materials for high speed rotors, advanced design tools
- Advanced stator and rotor materials to handle corrosive gases
- Improved drive electronics
  - higher fundamental frequencies for high speed machines
  - improved controls and bandwidth to provide low torque ripple
- Tighter integration of compressor, motor and drive components and engineering

(Raju)

### **I. Drive Electronics and Components**

#### **1. Existing Drive Electronics and Components**

Mechanical drives have been widely used in the past. They are available at high ratings and are independent of the requirements associated with electricity supply infrastructure. Compared to mechanical drives, electrical drives offer improved speed control, higher system efficiency, reduced maintenance, dynamic braking, the capability of short start-up time and load assumption, and elimination of the gear box that enables tight integration of drive motor with the compressor. Electrical drive challenges include the requirement of availability of on-site electricity and power ratings have to be met by both motor and frequency converter (“drive”). The integration advantages of electric drives include direct coupling of motor and compressor rotors thereby eliminating the gear box and the ability to cool motors with the flow of process gas. The power train can be levitated by magnetic bearings. As a result of these characteristics, there is the potential for substantial simplification of compression stations through the use of electric drives in place of mechanical drives.

Permanent magnet motor technology using rare-earth permanent magnet rotor poles, metallic retaining ring and magnetization after assembly, offer the benefits of robust manufacturing processes, no active rotor components, and minimal heating and thermal cycling. (Raju/Weeber)

The use of SiC based components in place of Si-based components can enhance the performance of semiconductor power devices by an order of magnitude for switching frequency and a factor of 5 for device voltage, as shown in Figure 2.5

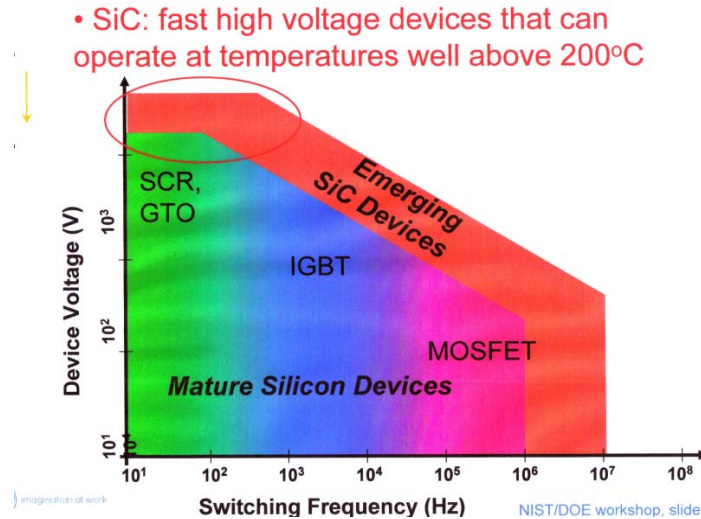

**Figure 2.5 Semiconductor Power Devices (Stevanovic)**

Currently, there are no commercially available SiC devices that are capable of operating at 10 kV. Robust, reliable devices scaleable to >1 kA are also needed. The challenges facing currently available power modules include thermal limitations, electrical de-rating, and wirebond reliability. New soft magnetic materials have the advantages of minimizing hysteretic losses, minimizing eddy current losses and maximizing materials utilization. (Stevanovic)

Today's commercial market for power conditioning devices, used primarily in Power Factor Correction (PFC) and solar power conversion applications, utilizes Si (silicon)-based 600-1200 V, 5 A-50 A components. Silicon Carbide (SiC) based components offer significant technical advantages relative to silicon components, which are summarized below:

- 10X Breakdown Field of Si
  - Tradeoff higher breakdown voltage
  - Lower specific on-resistance
  - Faster switching
- 3X Thermal Conductivity of Si
  - Higher current densities
- 3X Bandgap of Si
  - Low  $n_i \Rightarrow$  Low leakage current
  - Higher temperature operation

Today SiC based components are relatively expensive but larger production volumes and larger wafer sizes (4 inch diameter instead of 3 inch diameter) are resulting in continuous product cost reduction.

Recent field experience with SiC-based test components was reported at the Workshop by Cree. A 2.4 % increase in efficiency of a 3-phase solar inverter was achieved using Cree 1200 V SiC DMOSFETs in place of 1200 V Si IGBTs. Significant cost savings were achieved by reducing losses in power conversion efficiency. Switching losses with 3.3 kV SiC DMOSFET were more than >10X lower than with 3 kV Si IGBT at 125 °C. The 3.3 kV SiC DMOSFET is capable of 20 kHz switching operation. Early field data is showing a 10X lower failure rate than comparable silicon-based parts. (Palmour)

## **2. R&D to Support Future Drive Electronics and Components**

Robust, reliable devices scaleable to >1 kA are needed. There are no commercially available 10 kV SiC devices. The challenges include:

- VON(T) for majority carrier devices
- Improving the yield of large MOS-gated (FET, IGBT) devices
- Gate oxide reliability, stability
- Bipolar degradation

There are no commercially available >10 kV, >1 kA modules. Design challenges include:

- Device interconnect for high currents and temperatures
- Materials CTE matching
- Fault tolerant to open/short failure
- High performance (top & bottom) device cooling

Development of new magnetic materials requires R&D to:

- Advance alloy theory and modeling to impact: saturation magnetization, anisotropy magnetostriction
- Apply advanced magnetic and structural probes to magnetic materials
- Develop new process routes to achieve desired microstructures
- Validate material performance in pilot-scale processing (Stevanovic)

To provide the needed capabilities for 10 kV devices, SiC IGBTs, GTOs and PiN Diodes are needed. This will require:

- SiC production and reliability proven at low voltages (600-1200 V) and running in high volume
- SiC MOSFETs nearing production at 1.2 kV, and 3.2 kV – 10 kV devices are proven and circuit demos show incredible performance
- For higher voltage (>10 kV), GTOs and IGBTs have been demonstrated
- SiC will enable high voltage drive trains with efficiencies and frequencies far in excess of what can be achieved in Si (Palmour)

## **3. Prioritization of Potential R&D Projects**

Workshop participants were asked to suggest research projects for consideration by the group and subsequent prioritization. Similar suggestions were combined with one another to reduce the

number of proposed projects. A total of 33 projects were suggested which were organized into seven categories.

The voting process allocated 100 total votes to each participant. Individuals could distribute their votes among as many projects as they wished, but were not allowed to award more than thirty votes to any one project. As a result of time constraints, participants were asked to submit their completed ballots by email. A total of 37 individuals participated. Employees of the sponsoring organizations (DOE, NIST, and EPRI) did not participate in the prioritization process.

Tables 3.1 presents the distribution of total votes among the seven categories. Table 3.2 lists the ten highest ranked projects. Tables 3.3 through 3.9 present the total votes for R&D projects in each of the seven categories.

The highest ranked category and highest ranked projects related to the need to have more accurate prediction methodologies available for calculating the thermodynamic properties of mixtures of CO<sub>2</sub> containing relatively small concentrations of contaminants totaling less than about 5 %. This category and topic were followed in priority by projects to improve integration of the capture and compression systems.

**Table 3.1 Category Rank Order**

<b>Category Rank Order</b>	<b>Total Votes</b>
<b>1. Properties of CO<sub>2</sub> and Co-constituents</b>	<b>914</b>
<b>2. Integration of CO<sub>2</sub> Capture and Compression</b>	<b>726</b>
<b>3. Compression Systems Machinery and Components</b>	<b>690</b>
<b>4. Electric Drive Machinery</b>	<b>545</b>
<b>5. Pipeline Issues</b>	<b>456</b>
<b>6. Drive Electronics and Components</b>	<b>326</b>
<b>7. Impacts of Legislation on CCS</b>	<b>43</b>



**Table 3.2 R&D Project Rank Order**

<b>R&amp;D Project</b>	<b>Total Votes</b>
1. Perform more gas properties measurements of CO <sub>2</sub> mixtures	435
2. Improve Equations of State	401
3. Optimize integration of a CO <sub>2</sub> capture/compression systems together with the power plant	280
4. Comparison and evaluation of compression-liquefaction and pumping options and configurations	204
5. Higher voltage, higher power, and speed machines and drives.	165
6. Install test coupons in existing CO <sub>2</sub> pipelines to obtain corrosion data, then develop CO <sub>2</sub> product specifications	150
7. Determine optimal machine types, speeds, needed voltages, etc. for CO <sub>2</sub> compressors	143
8. Establish allowable levels of contaminants in CO <sub>2</sub> pipeline and/or compressors	120
9. Compressor heat exchanger data for power plant applications including supercritical fluids	117
10. Integrate utilization of waste heat to improve cycle efficiency	113

**Table 3.3 Voting Distribution - Properties of CO<sub>2</sub> and Co-constituents**

Category	Total R&D Project Votes (Rank Order)	R&D Project Descriptions
<p><b>1. Properties of CO<sub>2</sub> and Co-constituents</b></p> <p><b>Total Category Votes = 914</b></p>	<p>435 (1)</p>	<p>Perform more gas properties measurements of CO<sub>2</sub> mixtures</p> <ul style="list-style-type: none"> <li>• Collect experimental PVT and VLE data and develop correlations for systems with 60-100 % CO<sub>2</sub>, 0-40 % H<sub>2</sub>S, 0-5 % Ar, and 0-5 % N<sub>2</sub>, H<sub>2</sub>O</li> <li>• Develop an understanding of the impact of Ar and N<sub>2</sub> and the pressure required to obtain dense phase supercritical CO<sub>2</sub></li> <li>• Thermodynamic properties of CO<sub>2</sub> and ranges of impurities expected in CCS applications within vapor dome is liquid (also supercritical)</li> <li>• Variable speed of sound pulsation models (real gas effects)</li> <li>• Provide experimental data of CO<sub>2</sub> and co-constituents properties including (NH<sub>3</sub>)<sub>2</sub> at pressures ranging from 5-2500 psia and then develop simulation model with experimental data</li> </ul>
	<p>401 (2)</p>	<p>Improve Equations of State</p> <ul style="list-style-type: none"> <li>• Equation of State predictions at all pressures with water present at various concentrations</li> <li>• Establish standard equations of state usage in analysis</li> <li>• Refine equation of state near critical point and with mixtures from 1 psia up to 11,000 psia</li> </ul>
	<p>78 (21)</p>	<p>Define compositions/pressures for power plants, reinjection recycle, pipeline</p>

**Table 3.4 Voting Distribution - Integration of CO<sub>2</sub> Capture and Compression**

Category	Total R&D Project Votes (Rank Order)	R&D Project Descriptions
<b>Integration of CO<sub>2</sub> Capture and Compression</b>	280 (3)	Optimized integration of a CO <sub>2</sub> capture/compression systems together with the power plant
<b>Total Category Votes = 726</b>	161 (6)	Evaluate cost/benefits for various CO <sub>2</sub> capture options based on various CO <sub>2</sub> impurity specs (10 ppm, 50 ppm, 100 ppm, 1000 ppm)
	113 (11)	Integrate utilization of waste heat to improve cycle efficiency
	91 (16)	Evaluate alternate CO <sub>2</sub> compressor drives (steam and gas turbines)
	81 (20)	IGCC Demonstration project with CO <sub>2</sub> capture to reduce risk and enhance workability

**Table 3.5 Voting Distribution - Compression Systems Machinery and Components**

<b>Category</b>	<b>Total R&amp;D Project Votes (Rank Order)</b>	<b>R&amp;D Project Descriptions</b>
<b>Compression Systems Machinery and Components</b>	204 (4)	Comparison and evaluation of compression-liquefaction and pumping options and configurations
<b>Total Category Votes = 690</b>	117 (10)	Compressor heat exchanger data for power plant applications including supercritical fluids
	99 (15)	Advanced rotating equipment clearance control and sealing technology demonstration
	91 (16)	Axial compression system demonstrator for 13 k ton/day
	90 (18)	Design very large axial compressors to provide initial stages of compression followed by conventional HP compressors
	48 (25)	Integrated back-pressure steam turbine and CO <sub>2</sub> compressor
	30 (28)	Document duty cycle requirements for reference plant
	11 (31)	Improve reliability of recipe EOR recycle compressors, i.e. valve reliability, lubrication

**Table 3.6 Voting Distribution =- Electric Drive Machinery**

<b>Category</b>	<b>Total R&amp;D Project Votes (Rank Order)</b>	<b>R&amp;D Project Descriptions</b>
<b>Electric Drive Machinery</b>  <b>Total Category Votes = 545</b>	165 (5)	Higher voltage, higher power, and speed machines and drives.
	143 (8)	Determine optimal machine types, speeds, needed voltages, etc. for CO <sub>2</sub> compressors
	111 (12)	Tighter integration of compressor, motor and drive components and engineering.
	56 (23)	Improve drive electronics <ul style="list-style-type: none"> <li>• higher fundamental frequencies for high speed machines, improved controls, and bandwidth to provide low torque ripple</li> </ul>
	45 (26)	Advanced Stator and Rotor cooling schemes
	15 (28)	Improve materials for high speed rotors and advanced design tools
	10 (32)	Advanced Stator and Rotor materials to handle corrosive gases

**Table 3.7 Voting Distribution - Pipeline Issues**

<b>Category</b>	<b>Total R&amp;D Project Votes (Rank Order)</b>	<b>R&amp;D Project Descriptions</b>
<b>Pipeline Issues</b>  <b>Total Category Vote - 456</b>	150 (7)	Install test coupons in existing CO <sub>2</sub> pipelines to obtain corrosion data, then develop CO <sub>2</sub> product specifications including H <sub>2</sub> O, O <sub>2</sub> , NH <sub>3</sub> , TEG, Amines
	120 (9)	Establish allowable levels of contaminants in CO <sub>2</sub> pipeline and/or compressors
	111 (12)	Perform optimization of pipeline booster stations. Station spacing, liquid vs. gas, driver selection

	75 (22)	Perform further corrosion studies on the effects of moisture on pipeline corrosion
--	------------	--

**Table 3.8 Voting Distribution - Drive Electronics and Components**

<b>Category</b>	<b>Total R&amp;D Project Votes (Rank Order)</b>	<b>R&amp;D Project Descriptions</b>
<b>Drive Electronics and Components</b>  <b>Total Category Votes= 326</b>	108 (14)	Development of SiC components and inverter modules for cost effective variable speed drive and cost effective electrically driven compressors <ul style="list-style-type: none"> <li>• Manufacturing and cost reduction for SiC power modules</li> <li>• Determine and develop optimal device type for CO<sub>2</sub> compression application</li> </ul>
	88 (19)	Integration of CO <sub>2</sub> compression electric drive with power plant electrical system
	55 (24)	Development and demonstration of high voltage, high frequency motor drives
	45 (26)	Integration of pipeline pumping station motor drive with electrical grid
	25 (29)	High frequency transformer magnetic materials: nano-crystalline magnetic materials
	5 (33)	High voltage, high current module packaging <ul style="list-style-type: none"> <li>• Better thermal performance</li> <li>• Better reliability</li> </ul>

**Table 3.9 Voting Distribution - Effects of Legislation on CCS**

<b>Category</b>	<b>Total R&amp;D Project Votes (Rank Order)</b>	<b>R&amp;D Project Descriptions</b>
<b>Effects of legislation on CCS</b>	43 (27)	Determine practical effects of new legislation on CCS (after new legislation is in place)
<b>Total Category Votes = 43</b>		

## 4. List of Workshop Presentations

Phil Amick, ConocoPhillips; *Gasification Project Outlook*

Peter Baldwin, RamGen; *Ramgen Power Systems*

Hans Axel Bratfos, DNV; *Risk Aspects Related to Pipeline Transmission of CO<sub>2</sub>*

Ray Hattenbach, Blue Source LLC; *Future Market Drivers for CO<sub>2</sub> Compression Equipment*

Carl Hustad, CO<sub>2</sub> Global; *CO<sub>2</sub> Compression for Advanced Oxy-Fuel Cycles*

Joy Kadnar, US Department of Transportation; *CO<sub>2</sub> Transportation Via Pipelines*

Kevin Kisor, MAN Turbo; *Centrifugal Compressors for High Pressure CO<sub>2</sub> Applications*

Dan Kubek, Gas Processing Solutions; *Large CO<sub>2</sub> Sources and Capture Systems*

Kenneth Kullinger, ABB; *High-megawatt Electric Drive Motors*

Vello Kuuskraa, Advanced Resources International; *Summary of Results from the EPRI Workshop on Costs of CO<sub>2</sub> Storage and Transportation*

Jim Maddocks, Gas Liquids Engineering; *Gas Processing*

Harry Miller, Dresser Rand; *Carbon Dioxide Compression*

Marco Minotti, GE; *CO<sub>2</sub> Compression Capabilities*

Jeff Moore, SwRI; *Research and Development Needs for Advanced Compression of Large Volumes of Carbon Dioxide*

Steve Moran, Converteam; *Multi-megawatt Motor Drive Technology Electronics*

John Palmour, Cree; *Future High-Voltage Silicon Carbide Power Devices*

Ravi Raju (for Konrad Weeber), GE Research; *Advanced Electric Machines Technology*

Ron Schoff, EPRI; *Introduction of Large Power Plants with CO<sub>2</sub> Capture and Compression*

Ljubisa Stevanovic, GE Energy; *Advanced Electronic Components for High Speed, High-megawatt Drives*

Richard Zhang, GE Oil and Gas; *High-megawatt Electric Drive Applications in Oil and Gas*



## 5. Appendices

### 5a. Workshop Agenda

#### Workshop on Future Large CO<sub>2</sub> Compression Systems

Sponsored by  
DOE Office of Clean Energy Systems, EPRI, and NIST

Dates  
March 30-31, 2009

#### March 30, 2009

- Future Market Outlook for CO<sub>2</sub> Compression and Sequestration
- Existing Industry Experience with CO<sub>2</sub> Compression
- Approaches to Improve Cost, Efficiency, Availability, and Safety

#### March 31, 2009

- Advanced Compressor Machinery R&D Needs
- Advanced Electric Drive Technology R&D Needs
- Identify and Prioritize R&D Needed for Future CO<sub>2</sub> Compressors

Time	Topics
	<u>First Day (March 30)</u>
8 AM	<b>Registration and Breakfast</b>
8:30 AM	<b>1.0 Opening Welcome</b> <ul style="list-style-type: none"> <li>• Introduction of Participants, Opening Remarks Al Hefner, NIST; Pete Rozelle, DOE; Rob Steele, EPRI</li> </ul> <b>1.1 Review of Workshop Objectives</b> <ul style="list-style-type: none"> <li>• Ron Wolk</li> </ul> <b>1.2 Keynote Speakers</b> <ul style="list-style-type: none"> <li>• Future Market Drivers for CO<sub>2</sub> Compression Equipment; Ray Hattenbach, Blue Source LLC</li> <li>• Introduction of Large Power Plants with CO<sub>2</sub> Capture and Compression; Ron Schoff, EPRI</li> </ul>
10:00 AM	<b>Break</b>
10:20 AM	<b>2.0 Oil and Gas Industry Experience with CO<sub>2</sub> Compressors and Pipelines</b> <ul style="list-style-type: none"> <li>• Joy Kadnar, US Department of Transportation; CO<sub>2</sub> Transportation Via Pipelines</li> <li>• Hans Axel Bratfos, DNV; Risk Aspects Related to Pipeline Transmission of CO<sub>2</sub></li> <li>• Dan Kubek, Gas Processing Solutions; Large CO<sub>2</sub> Sources and Capture Systems</li> <li>• Vello Kuuskraa, Advanced Resources International; Summary of</li> </ul>

	<p><b>Results from the EPRI Workshop on Costs of CO<sub>2</sub> Storage and Transportation</b></p> <p><b>2.1 Panel Discussion</b></p> <ul style="list-style-type: none"> <li>• <b>Jim Maddocks, Gas Liquids Engineering</b></li> <li>• <b>Phil Amick, ConocoPhillips</b></li> </ul>
<b>12:15 PM</b>	<b>Lunch</b>
<b>1:15 PM</b>	<p><b>3.0 Compressor Vendor Perspective on Changes in Compression Cycle, Machinery, and CO<sub>2</sub> Capture System to Increase Energy Efficiency</b></p> <ul style="list-style-type: none"> <li>• <b>Harry Miller, Dresser Rand; Dresser-Rand Centrifugal and Reciprocating Compressor Technology and Experience with CO<sub>2</sub> Compression Applications.</b></li> <li>• <b>Kevin Kisor, MAN Turbo; Compressors for High Pressure CO<sub>2</sub> Applications</b></li> <li>• <b>Marco Minotti, GE; CO<sub>2</sub> Compression Capabilities</b></li> </ul>
<b>3 PM</b>	<b>Break</b>
<b>3:30 PM</b>	<p><b>4.0 Electric Drive Compressor Potential for Improvement in Capitol Cost, Power Requirements, Availability, and Safety</b></p> <ul style="list-style-type: none"> <li>• <b>Richard Zhang, GE Oil and Gas; High-megawatt Electric Drive Applications in Oil and Gas</b></li> <li>• <b>Kenneth Kullinger, ABB; High-megawatt Electric Drive Motors</b></li> <li>• <b>Steve Moran, Converteam; High-megawatt Motor Drive Electronics</b></li> </ul>
<b>5 PM</b>	<b>Adjourn</b>
<b>6:30 PM</b>	<b>EPRI-Hosted Workshop Dinner</b>
	<b><u>Second Day (March 31)</u></b>
<b>8 AM</b>	<b>Breakfast</b>
<b>8:30 AM</b>	<p><b>5.0 Review Workshop Charge to Identify and Prioritize R&amp;D for Future CO<sub>2</sub> Compression Systems</b></p> <ul style="list-style-type: none"> <li>• <b>Ron Wolk</b></li> </ul>
<b>8:40 AM</b>	<p><b>6.0 Advanced Compressor Machinery Future R&amp;D Needs</b></p> <ul style="list-style-type: none"> <li>• <b>Jeff Moore, SwRI; Research and Development Needs for Advanced Compression of Large Volumes of Carbon Dioxide</b></li> <li>• <b>Carl Hustad, CO<sub>2</sub> Global; CO<sub>2</sub> Compression for Advanced Oxy-Fuel Cycles</b></li> <li>• <b>Peter Baldwin, RamGen; Ramgen Overview and Status Update</b></li> </ul>
<b>10 AM</b>	<b>Break</b>
<b>10:30 AM</b>	<p><b>7.0 Advanced Electric Drive Compressor Future R&amp;D Needs</b></p> <ul style="list-style-type: none"> <li>• <b>Ravi Raju for Konrad Weeber, GE Research; Advanced PM and Synchronous Machine Technology</b></li> <li>• <b>Ljubisa Stevanovic, GE Energy; Advanced Electronic Components for High Speed, High-megawatt Drives</b></li> <li>• <b>John Palmour, Cree; Future High-Voltage SiC Power Device Manufacturing Technology</b></li> </ul>

<b>Noon</b>	<b>Lunch</b>
<b>1 PM</b>	<b>8.0 Compilation of Potential R&amp;D Areas</b> <b>Workshop Participants, (Ron Wolk, Facilitator)</b> <ul style="list-style-type: none"> <li>• <b>Capture and Compression System Modifications</b></li> <li>• <b>Potential Compressor Machinery Improvements</b></li> <li>• <b>Potential Electric Drive Compressor Developments</b></li> <li>• <b>Potential Improvements in High Power Electronics</b></li> </ul>
<b>2:00 PM</b>	<b>R&amp;D Prioritization Exercise</b> <b>Workshop Participants, (Ron Wolk, Facilitator)</b>
<b>3:00 PM</b>	<b>Adjourn</b>

## 5b. Workshop Participants

Last Name	First Name	Company	E-mail
Agarwal	Anant	Cree Inc.	Anant_Agarwal@cree.com
Alsup	Charles (Chuck)	DOE/NETL	calsup@netl.doe.gov
Altpeter	Paul D.	Air Products and Chemicals	altpetpd@airproducts.com
Ames	Robin	NETL - DOE	Robin.Ames@NETL.DOE.GOV
Amick	Phil	Conoco-Phillips	Phil.Amick@ConocoPhillips.com
Anderson	Malcolm	Southern California Edison	malcolm.anderson@sce.com
Baldwin	Peter	Ramgen Power Systems	pete_baldwin@ramgen.com
Beermann-Curtin	Sharon	DARPA	Sharon.Beermann-curtin@darpa.mil
Behnke	Paul W.	Bechtel	PWBEHNKE@BECHTEL.COM
Bender	William	Technology & Management Services	wbender@tms-hq.com
Biondo	Sam	DOE Headquarters	SAMUEL.BIONDO@HQ.DOE.GOV
Boal	Charles	Elliott Company	cboal@elliott-turbo.com
Bower	Richard D. (Rick)	Alter NRG Corp.	rbower@alternrg.ca
Bratfos	Hans Axel	Det Norske Veritas (DNV) Energy	hans.axel.bratfos@dnv.com
Brent	Richard	Solar Turbines	cochraham_nicole@solarturbines.com
Brostmeyer	Joseph	Florida Turbine Technologies	jbrostmeyer@fttinc.com
Brown	Barry	Florida Turbine Technologies	bbrown@fttinc.com
Bygrave	Jonathan W.	Rolls-Royce Energy Systems, Inc.	jonathan.bygrave@rolls-royce.com
Colangelo	Mike	A.O. Smith	Mike.Colangelo@AOSEPC.COM
Davis	Gary	Elliott Company	gdavis@elliott-turbo.com
Dennis	Richard	US DOE - NETL	Richard.dennis@netl.doe.gov
Ericson	Terry	ONR	ericset@onr.navy.mil
Faller	Wolfgang	Solar Turbines, Inc.	Faller_Wolfgang@solarturbines.com
Feier	Ioan	Battelle Memorial Institute	feieri@battelle.org
Gaspar	Jeff	Converteam	jeffrey.gaspar@converteam.com
Hannon	Cesar	ALSTOM Power - Environmental Control Systems	cesar.hannon@power.alstom.com
Hattenbach	Ray P	Blue Source LLC	rhattenbach@bluesource.com
Hefner	Allen	NIST	allen.hefner@nist.gov
Hoffman	James	DOE/NETL	jhoffman@netl.doe.gov
Hood	Colleen	NIST	colleen.hood@nist.gov
Hoover	Ron	Southern California Edison	Ronald.hoover@sce.com
Hopkinson	David	DOE	david.hopkinson@hq.doe.gov
Horiba	Junichi	Mitsubishi Heavy Industries America, Inc.	junichi_horiba@mhiahq.com
Huntington	Richard	ExxonMobil Research & Engineering Co.	Richard.huntington@exxonmobil.com
Hustad	Carl-W.	CO2-Global	cwh@co2-global.com
Jones	Russell	Florida Turbine Technologies	rjones@fttinc.com
Kadnar	Joy O.	U.S Department of Transportation	Joy.kadnar@dot.gov

Kerth	Jason	Dresser-Rand	Jkerth@dresser-rand.com
Kindt	Jack T.	Air Products and Chemicals	kindtjt@airproducts.com
Kisor	Kevin W.	MAN Turbo Inc. USA	Kevin.Kisor@manturbo-us.com
Kubek	Dan	Gas Processing Solutions LLC	dan.kubek@sbcglobal.net
Kullinger	Kenneth	ABB	Kenneth.kullinger@se.abb.com
Kuuskaa	Vello A.	Advanced Resources International, Inc.	vkuuskaa@adv-res.com
Lai	Jason	Virginia Tech	laijs@vt.edu
Le	Patrick H.	US DOE/NETL	ple@netl.doe.gov
Ludwiczak	Christian	E.ON Ruhrgas AG	Christian.ludwiczak@eon-ruhrgas.com
Maddocks	Jim	Gas Liquids Engineering Ltd.	jmaddocks@gasliquids.com
Miller	Harry F.	Dresser-Rand	hmiller@dresser-rand.com
Minotti	Marco	GE Oil & Gas	Marco.minotti@ge.com
Moore	Jeff	Southwest Research Institute	jeff.moore@swri.org
Moran	Steven	Converteam Naval Systems	steven.moran@converteam-navsys.com
Muraskin	David	Alstom Power	David.j.Muraskin@power.alstom.com
Olliver	Richard A.	CH2M Hill	rolliver@ch2m.com
Omatick	Todd	Elliott Company	tomatick@elliott-turbo.com
Palmour	John	Cree, Inc.	john_palmour@cree.com
Peralta-Solorio	David	E.ON Engineering Ltd.	David/peralta-solorio@eon-engineeringuk.com
Pollard	Alicia	Elliott Company	apollard@elliott-turbo.com
Quedenfeld	Heather	U. S. DOE	heather.quedenfeld@netl.doe.gov
Raines	Tom	Alstom Power Environmental Control Systems	thomas.s.raines@power.alstom.com
Raju	Ravisekhar(Ravi)	General Electric Company	raju@crd.ge.com
Royal	John	Praxair Inc.	John_royal@praxair.com
Rozelle	Peter	DOE Headquarters	peter.rozelle@hq.doe.gov
Sadok	Richard D.	ConocoPhillips	Richard.D.Sadok@Conocophillips.com
Schoff	Ronald L.	Electric Power Research Institute	rschoff@epri.com
Shaffer	Ron	Curtiss-Wright EMD	Rshaffer2@curtisswright.com
Shelton	Walter W.	U.S. DOE / NETL/ OSAP	Walter.Shelton@NETL.DOE.GOV
Soghomonian	Dr. Zareh	BMT Syntek Technologies	zsoghomonian@bmtsyntek.com
Steele	Rob	EPRI	rsteale@epri.com
Stevanovic	Ljubisa	GE Global Research Center	stevanov@crd.ge.com
Temofonte	Peter	Turblex, a Siemens Company	peter.temofonte@siemens.com
Tipsword	Robert	Core Energy, LLC	btipsword@coreenergyllc.com
Wadas	Brian	G E Oil & Gas	brian.wadas@ge.com
Wen	Harvey	Bechtel Power Corp	hwen@bechtel.com
Wheeler	Emily	DOE	Emily.wheeler@hq.doe.gov
Williams	Ben	Ariel Corporation	bwilliams@arielcorp.com
Wolk	Ronald H.	Wolk Integrated Technical Services	ronwolk@aol.com
Worst	Jeff	Curtiss-Wright	jworst@curtisswright.com

Wung	Dr. Peter	A. O. Smith Electrical Products Company	Peter.wung@aosepc.com
Zgrabik	Larry	ABB Inc.	larry.l.zgrabik@us.abb.com
Zhang	Richard	GE Oil & Gas	zhangr@ge.com

Filename: March 2009 CO2 Workshop Proceedings.doc  
Directory: H:\colleen's Documents\Al's stuff\2009 Meetings\Co2  
Compression Wksp-March 30-31\Post to website\Proceedings - Wolk  
Template: C:\Documents and Settings\colleen\Application  
Data\Microsoft\Templates\Normal.dotm  
Title: CO2 Workshop Final Report  
Subject:  
Author: Ron Wolk  
Keywords:  
Comments:  
Creation Date: 5/12/2010 9:14:00 AM  
Change Number: 2  
Last Saved On: 5/12/2010 9:14:00 AM  
Last Saved By: colleen  
Total Editing Time: 5 Minutes  
Last Printed On: 7/28/2010 10:28:00 AM  
As of Last Complete Printing  
Number of Pages: 38  
Number of Words: 8,828 (approx.)  
Number of Characters: 50,498 (approx.)

# FINAL AGENDA

## Workshop on Future Large CO<sub>2</sub> Compression Systems

Sponsored by  
DOE Office of Clean Energy Systems, EPRI, and NIST

Dates  
March 30-31, 2009

### March 30, 2009

- Future Market Outlook for CO<sub>2</sub> Compression and Sequestration
- Existing Industry Experience with CO<sub>2</sub> Compression
- Approaches to Improve Cost, Efficiency, Availability, and Safety

### March 31, 2009

- Advanced Compressor Machinery R&D Needs
- Advanced Electric Drive Technology R&D Needs
- Identify and Prioritize R&D Needed for Future CO<sub>2</sub> Compressors

Time	Topics
	<b><u>First Day (March 30)</u></b>
8 AM	Registration and Breakfast
8:30 AM	1.0 Opening Welcome <ul style="list-style-type: none"><li>• Introduction of Participants, Opening Remarks Al Hefner, NIST; Pete Rozelle, DOE; Rob Steele, EPRI</li></ul> 1.1 Review of Workshop Objectives <ul style="list-style-type: none"><li>• Ron Wolk</li></ul> 1.2 Keynote Speakers <ul style="list-style-type: none"><li>• Future Market Drivers for CO<sub>2</sub> Compression Equipment; Ray Hattenbach, Blue Source LLC</li><li>• Introduction of Large Power Plants with CO<sub>2</sub> Capture and Compression; Ron Schoff, EPRI</li></ul>
10:00 AM	Break
10:20 AM	2.0 Oil and Gas Industry Experience with CO <sub>2</sub> Compressors and Pipelines <ul style="list-style-type: none"><li>• Joy Kadnar, US Department of Transportation; CO<sub>2</sub> Transportation Via Pipelines</li><li>• Hans Axel Bratfos, DNV; Risk Aspects Related to Pipeline Transmission of CO<sub>2</sub></li><li>• Dan Kubek, Gas Processing Solutions; Large CO<sub>2</sub> Sources and Capture Systems</li><li>• Vello Kuuskraa, Advanced Resources International; Summary of Results from the EPRI Workshop on Costs of CO<sub>2</sub> Storage and Transportation</li></ul>



	<b>2.1 Panel Discussion</b> <ul style="list-style-type: none"> <li>• Jim Maddocks, Gas Liquids Engineering</li> <li>• Phil Amick, ConocoPhillips</li> </ul>
<b>12:15 PM</b>	<b>Lunch</b>
<b>1:15 PM</b>	<b>3.0 Compressor Vendor Perspective on Changes in Compression Cycle, Machinery, and CO2 Capture System to Increase Energy Efficiency</b> <ul style="list-style-type: none"> <li>• Harry Miller, Dresser Rand; Dresser-Rand Centrifugal and Reciprocating Compressor Technology and Experience with CO2 Compression Applications.</li> <li>• Kevin Kisor, MAN Turbo; Compressors for High Pressure CO2 Applications</li> <li>• Nicola Banchi, GE Italy</li> </ul>
<b>3 PM</b>	<b>Break</b>
<b>3:30 PM</b>	<b>4.0 Electric Drive Compressor Potential for Improvement in Capital Cost, Power Requirements, Availability, and Safety</b> <ul style="list-style-type: none"> <li>• Richard Zhang, GE Oil and Gas; High-megawatt Electric Drive Applications in Oil and Gas</li> <li>• Kenneth Kullinger, ABB; High-megawatt Electric Drive Motors</li> <li>• Steve Moran, Converteam; High-megawatt Motor Drive Electronics</li> </ul>
<b>5 PM</b>	<b>Adjourn</b>
<b>6:30 PM</b>	<b>EPRI-Hosted Workshop Dinner</b>
	<b><u>Second Day (March 31)</u></b>
<b>8 AM</b>	<b>Breakfast</b>
<b>8:30 AM</b>	<b>5.0 Review Workshop Charge to Identify and Prioritize R&amp;D for Future CO2 Compression Systems</b> <ul style="list-style-type: none"> <li>• Ron Wolk</li> </ul>
<b>8:40 AM</b>	<b>6.0 Advanced Compressor Machinery Future R&amp;D Needs</b> <ul style="list-style-type: none"> <li>• Jeff Moore, SwRI; Research and Development Needs for Advanced Compression of Large Volumes of Carbon Dioxide</li> <li>• Carl Hustad, CO2 Global; CO2 Compression for Advanced Oxy-Fuel Cycles</li> <li>• Peter Baldwin, RamGen; Ramgen Overview and Status Update</li> </ul>
<b>10 AM</b>	<b>Break</b>
<b>10:30 AM</b>	<b>7.0 Advanced Electric Drive Compressor Future R&amp;D Needs</b> <ul style="list-style-type: none"> <li>• Konrad Weeber, GE Research; Advanced PM and Synchronous Machine Technology</li> <li>• GE Energy (tbd); Advanced Electronic Components for High Speed, High-megawatt Drives</li> <li>• John Palmour, Cree; Future High-Voltage SiC Power Device Manufacturing Technology</li> </ul>
<b>Noon</b>	<b>Lunch</b>

<b>1 PM</b>	<b>8.0 Compilation of Potential R&amp;D Areas</b> <b>Workshop Participants, (Ron Wolk, Facilitator)</b> <ul style="list-style-type: none"><li>• <b>Capture and Compression System Modifications</b></li><li>• <b>Potential Compressor Machinery Improvements</b></li><li>• <b>Potential Electric Drive Compressor Developments</b></li><li>• <b>Potential Improvements in High Power Electronics</b></li></ul>
<b>2:00 PM</b>	<b>R&amp;D Prioritization Exercise</b> <b>Workshop Participants, (Ron Wolk, Facilitator)</b>
<b>3:00 PM</b>	<b>Adjourn</b>

## **ANNOUNCEMENT**

# **Workshop on Future Large CO<sub>2</sub> Compression Systems**

**Sponsored by  
DOE Office of Clean Energy Systems, EPRI, and NIST**

**Dates  
March 30-31, 2009**

**Location  
Advanced Metrology Laboratory (AML) Conference Room  
National Institute of Standards and Technology (NIST) Headquarters,  
100 Bureau Drive, Gaithersburg, MD 20899**

### **Background**

Pipeline transportation of large quantities of compressed carbon dioxide from both natural and industrial sources is a well established industry. The transported CO<sub>2</sub> is used primarily for enhanced oil recovery and secondarily for industrial use. Concerns about global warming related to CO<sub>2</sub> emissions have intensified interest in carbon capture at power plants with subsequent transportation to long-term sequestration sites. DOE has instituted R&D programs to investigate the integrated capture, compression, transportation, and sequestration of compressed CO<sub>2</sub>.

Advances in compression technology in both the mechanical and electric drive systems of the compression machinery have the potential to improve system performance by reducing both capitol investment and energy requirements.

### **Workshop Objectives**

At this workshop, we will review the field experience obtained in commercial CO<sub>2</sub> compression and pipeline projects, discuss on-going compressor product development efforts, and then identify and prioritize apparent compressor R&D gaps for consideration by industry, academia and government.

### **Registration**

If you are interested in attending, please email the attached registration form to Colleen Hood ([colleen.hood@nist.gov](mailto:colleen.hood@nist.gov)) prior to March 20, 2009.

### **Attachments**

A preliminary agenda, registration form, and logistical information are attached.

# PRELIMINARY AGENDA

## Workshop on Future Large CO<sub>2</sub> Compression Systems

Sponsored by  
DOE Office of Clean Energy Systems, EPRI, and NIST

Dates  
March 30-31, 2009

### March 30, 2009

- Future Market Outlook for CO<sub>2</sub> Compression and Sequestration
- Existing Industry Experience with CO<sub>2</sub> Compression
- Approaches to Improve Cost, Efficiency, Availability, and Safety

### March 31, 2009

- Advanced Compressor Machinery R&D Needs
- Advanced Electric Drive Technology R&D Needs
- Identify and Prioritize R&D Needed for Future CO<sub>2</sub> Compressors

Time	Topics
	<u>First Day (March 30)</u>
8 AM	Registration and Breakfast
8:30 AM	<b>1.0 Opening Welcome</b> <ul style="list-style-type: none"><li>• Introduction of Participants, Opening Remarks</li><li>• Review of Workshop Objectives</li></ul> <b>1.1 Keynote Speakers</b> <ul style="list-style-type: none"><li>• Future Market Drivers for CO<sub>2</sub> Compression Equipment</li><li>• CO<sub>2</sub> Capture Approaches for Coal and Natural Gas Plants</li></ul>
10:00 AM	Break
10:30 AM	<b>2.0 Oil and Gas Industry Experience with CO<sub>2</sub> Compressors and Pipelines</b> <ul style="list-style-type: none"><li>• Operating Issues</li><li>• Maintenance Issues</li><li>• Safety Issues/Areas of Concern</li><li>• Areas of Potential Cost Savings</li><li>• Materials Issues</li></ul>

	<ul style="list-style-type: none"> <li>• Contaminants</li> </ul>
<b>Noon</b>	<b>Lunch</b>
<b>1:00 PM</b>	<b>3.0 Compressor Vendor Perspective on Changes in Compression Cycle, Machinery, and CO2 Capture System to Increase Energy Efficiency</b> <ul style="list-style-type: none"> <li>• Reduce Inter-stage Cooling Energy Losses</li> <li>• Modify Compressor Cycle</li> <li>• Increase Acceptable Levels of H2S/SO2/O2/Other Contaminants</li> </ul>
<b>3 PM</b>	<b>Break</b>
<b>3:30 PM</b>	<b>4.0 Electric Drive Compressor Potential for Improvement in Capital Cost, Power Requirements, Availability, and Safety</b> <ul style="list-style-type: none"> <li>• Steam versus Electric Drive</li> <li>• High-Megawatt Electric Drive Technology Status/Issues</li> <li>• Recent High-Megawatt Electric Drive Compressor Products for LNG refrigeration, NG distribution, and ASUs</li> </ul>
<b>5 PM</b>	<b>Adjourn</b>
<b>6:30 PM</b>	<b>Hosted Workshop Dinner</b>
	<b><u>Second Day (March 31)</u></b>
<b>8 AM</b>	<b>Breakfast</b>
<b>8:30 AM</b>	<b>5.0 Review Workshop Charge to Identify and Prioritize R&amp;D for Future CO2 Compressors</b>
<b>8:40 AM</b>	<b>6.0 Advanced Compressor Machinery Future R&amp;D Needs</b> <ul style="list-style-type: none"> <li>• Recently Introduced Product Improvements</li> <li>• Future Improvements that are Currently in the Product Pipeline</li> <li>• Future Technologies that may Provide Substantial Improvement</li> </ul>
<b>10 AM</b>	<b>Break</b>
<b>10:30 AM</b>	<b>7.0 Advanced Electric Drive Compressor Future R&amp;D Needs</b> <ul style="list-style-type: none"> <li>• High-Megawatt Electric Motors</li> <li>• High-Megawatt Drive Electronics</li> <li>• Advanced High Power Electronic Components including SiC Power Semiconductors</li> </ul>
<b>Noon</b>	<b>Lunch</b>
<b>1 PM</b>	<b>8.0 Compilation of Potential R&amp;D Areas</b> <ul style="list-style-type: none"> <li>• Capture and Compression System Modifications</li> <li>• Potential Compressor Machinery Improvements</li> <li>• Potential Electric Drive Compressor Developments</li> <li>• Potential Improvements in High Power Electronics</li> </ul>
<b>2:00 PM</b>	<b>R&amp;D Prioritization Exercise</b>
<b>3:00 PM</b>	<b>Adjourn</b>

## REGISTRATION FORM

### Workshop on Future Large CO2 Compression Systems March 30-31, 2009

Please Submit Before March 20, 2009:  
email to [colleen.hood@nist.gov](mailto:colleen.hood@nist.gov)

<b>Name:</b>	
<b>Organization:</b>	
<b>Mail Address:</b>	
<b>Email Address:</b>	
<b>Telephone Number:</b>	
<b>Fax Number:</b>	
<b>I will attend March 30 Workshop Dinner</b>	<input type="checkbox"/> <b>Yes</b> <input type="checkbox"/> <b>No</b>
<b>Indicate any Special Needs:</b>	

**NON-US CITIZENS PLEASE COMPLETE THE FOLLOWING ADDITIONAL  
FORM FOR NIST SECURITY**

<b>Date of Birth:</b>	
<b>Passport #:</b>	
<b>Issuing Passport Country:</b>	
<b>Citizenship:</b>	
<b>Employer/Sponsor</b>	
<b>Country of Residence:</b>	

## LOGISTICAL INFORMATION

### Workshop on Future Large CO<sub>2</sub> Compression Systems March 30-31, 2009

*Please be advised that all meeting participants will need to register in advance and provide a photo ID upon arrival at NIST's main gate at Diamond Avenue and 100 Bureau Drive, Gaithersburg, MD.* There will be no day-of-meeting registrations. We encourage those who have not yet made a decision to join us in this important endeavor to please contact Al Hefner ([hefner@nist.gov](mailto:hefner@nist.gov)) or Colleen Hood ([colleen.hood@nist.gov](mailto:colleen.hood@nist.gov)) prior to February 27 or Ron Wolk ([ronwolk@aol.com](mailto:ronwolk@aol.com), 408-996-7811) after February 27, 2009, if you have any questions.

Local ground transportation, maps/directions from the major Washington DC-Baltimore area airports, and more travel information may be found at: [http://www.nist.gov/public\\_affairs/visitor/visitor.htm](http://www.nist.gov/public_affairs/visitor/visitor.htm). Maps of the NIST site with building and parking directions, and the areas surrounding NIST are given below.

#### **Hotel Accommodations**

A room block at the government rate of \$129 has been arranged for the nights of March 29 and 30, 2009 at:

Gaithersburg Hilton  
620 Perry Parkway  
Gaithersburg, MD 20877  
Tel 301-977-8900 Fax 301-869-8597

**Gaithersburg Hilton reservation** for this event (**CO<sub>2</sub> Compression**) includes:

Free Breakfast  
Free Transportation to and from NIST site for Workshop  
Free Transportation to and from restaurant for Workshop Dinner 3/30/09

**To make your hotel reservation**, please contact the hotel directly. The room block name is: **CO<sub>2</sub> Compression**. The room block will be held until March 20 2009, after which unreserved rooms in block will be released. You may go to: [Gaithersburg Hilton](#) for additional maps/driving directions and other hotel information.

#### **Food Accommodations**

Lunch, coffee, drinks and snacks will be provided on March 30 and 31 during the Workshop. A Workshop Dinner will also be provided on March 30, 2009. Transportation to the dinner will be provided for attendees staying at the Gaithersburg Hilton and driving directions to the restaurant will also be provided.

## Other Area Hotels

Please note that transportation to NIST and the Workshop Dinner are only provided for the Gaithersburg Hilton:

### [Gaithersburg Hilton](#)

(room block name: **CO2 Compression**)

620 Perry Parkway

Gaithersburg, MD 20877

Tel 301-977-8900 Fax 301-869-8597

### [Courtyard Marriott-Gaithersburg](#)

805 Russell Ave.

Gaithersburg, MD 20879

(301) 670-0008 Fax: (301) 948-4538

### [Holiday Inn](#)

2 Montgomery Village Ave.

Gaithersburg, MD 20879

(301) 948-8900 Fax: (301) 258-1940

### [Courtyard Gaithersburg Washingtonian Center](#)

204 Boardwalk Place, Gaithersburg, MD 20878

Gaithersburg, MD 20877

(301) 527-9000 Fax: (301) 527-9001

### [SpringHill Suites by Marriott-Gaithersburg](#)

9715 Washingtonian Blvd.

Gaithersburg, MD 20878

(301) 987-0900 Fax: (301) 987-0500

### [Residence Inn by Marriott-Gaithersburg](#)

9721 Washingtonian Blvd.

Gaithersburg, MD 20878

(301) 590-3003 Fax: (301) 590-2722

### [Gaithersburg Marriott Washingtonian Center](#)

9751 Washingtonian Blvd.

Gaithersburg, MD 20878

(301) 590-0044 Fax: (301) 212-6155



## **Transportation to and from NIST:**

### **Gaithersburg Hilton Provided Transportation:**

The Hilton shuttle will run several times before and after the Workshop each day (stops at the NIST guard gate to pick up visitor badge and then continues to the AML meeting building).

### **Individual Traveler to NIST by Car:**

**From northbound I-270** take Exit 10, Route 117 West, Clopper Road. Bear right at the first light onto Clopper Road/West Diamond Avenue. At the next light, turn left onto the NIST grounds.

**From southbound I-270** take Exit 11, Route 124, Montgomery Village Avenue/Quince Orchard Road. Bear right at the first light onto Route 124 West, Quince Orchard Road. After you merge onto Rt. 124, Quince Orchard Road, turn left at the second light onto Route 117, West Diamond Avenue. Turn right at the first light onto NIST grounds.

**Upon Arrival at NIST by Car:** When you turn off of Diamond Avenue into the NIST main entrance, proceed to the main gate, staying to the right and enter the Visitor's Center parking lot. You will need to go inside the Visitor's center and show your picture ID to pick up your visitor pass to enter for March 30 and 31. Once you have your pass, turn left onto North Drive. (Road signs for the meeting will guide you to the Building 216 parking lot. ) North Drive will bear around to the right and bring you to a crossroad where you will turn left onto East Drive. Then follow signs into the building 216 parking lot. There will be someone at the door of building 216 to let you in and direct you to the meeting room straight down the hall.

### **Individual Traveler to NIST by Metro:**

The headquarters site of the National Institute of Standards & Technology is located near Gaithersburg, Maryland, just off Interstate Route 270, about 25 miles (40 kilometers) from the center of Washington, D.C. NIST provides shuttle service from the Shady Grove Metro (subway) station. For further information on transportation, food/dining, hotels/motels and more, see the [Visitor Information](#) page. (also, please let us know in advance if you will be taking metro.)

After arriving at Shady Grove Metro Center, go through turnstiles and turn right through tunnel to the East Kiss and Ride parking lot. After exiting tunnel turn to the right to find the bus stop. The NIST shuttle leaves Shady Grove Metro Center every half hour starting at 6:45 am. (The last return shuttle leaves NIST at 6:00 pm.) The shuttle will drop you at the Visitor's Center for you to pick up your visitor badge. We will arrange someone to transport you from the main gate to the meeting building (please let us know in advance if you will be taking metro.)

**MAP of NIST Site Indicating driving directions to Visitor Center and AML parking lot, and then to AML Conference room.**

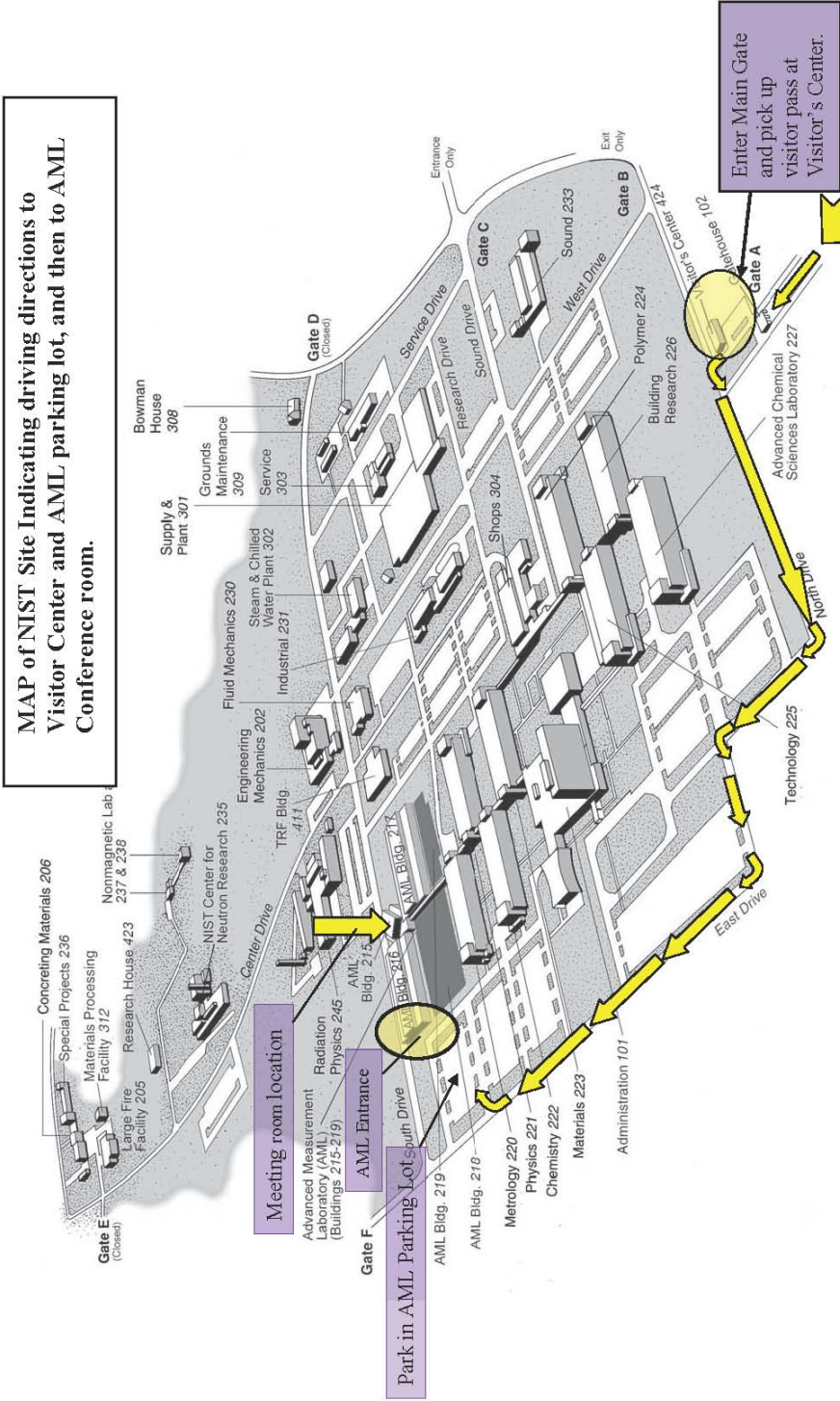

For information or help at anytime while at NIST, call 301-975-2054.

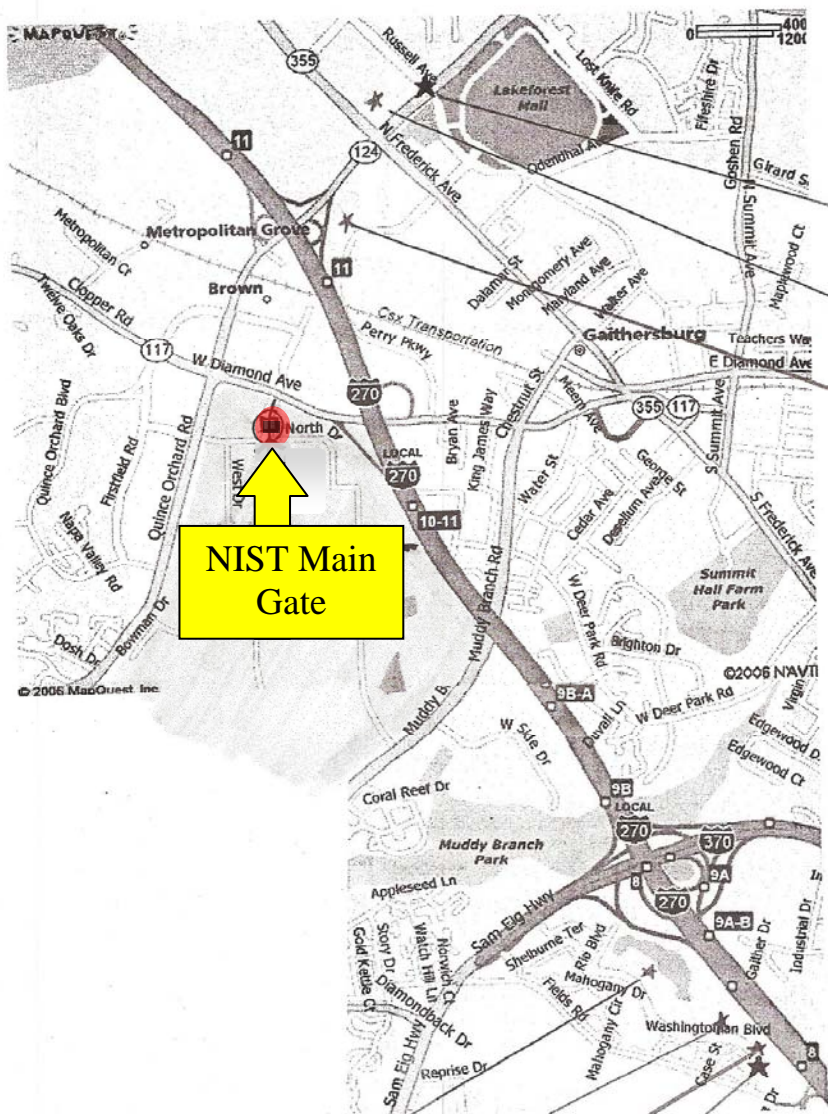

**NIST Main Gate**

1. Courtyard Marriott-Gaithersburg  
805 Russell Ave.  
Gaithersburg, Md., 20879  
(301) 670-0008 Fax: (301) 948-4538
2. Holiday Inn  
2 Montgomery Village Ave.  
Gaithersburg, Md., 20879  
(301) 948-8900 Fax: (301) 258-1940
3. Gaithersburg Hilton  
620 Perry Parkway  
Gaithersburg, Md., 20877  
(301) 977-8900 Fax: (301) 869-8597

4. Courtyard Gaithersburg Washingtonian Center  
204 Boardwalk Place, Gaithersburg, Md. 20878  
(301) 527-9000 Fax: (301) 527-9001
5. SpringHill Suites by Marriott-Gaithersburg  
9715 Washingtonian Blvd.  
Gaithersburg, MD 20878  
(301) 987-0900 Fax: (301) 987-0500
6. Residence Inn by Marriott-Gaithersburg  
9721 Washingtonian Blvd.  
Gaithersburg, MD 20878  
(301) 590-3003 Fax: (301) 590-2722
7. Gaithersburg Marriott Washingtonian Center  
9751 Washingtonian Blvd.  
Gaithersburg, Md. 20878  
(301) 590-0044 Fax: (301) 212-6155



**Presentations**

Session 1.0



**Opening Welcome**  
Hefner

# Welcome to Workshop on Future Large CO<sub>2</sub> Compression Systems



# **FINAL AGENDA**

## **Workshop on Future Large CO<sub>2</sub> Compression Systems**

**Sponsored by  
DOE Office of Clean Energy Systems, EPRI, and NIST**

Dates  
March 30-31, 2009

### March 30, 2009

- Future Market Outlook for CO<sub>2</sub> Compression and Sequestration
- Existing Industry Experience with CO<sub>2</sub> Compression
- Approaches to Improve Cost, Efficiency, Availability, and Safety

### March 31, 2009

- Advanced Compressor Machinery R&D Needs
- Advanced Electric Drive Technology R&D Needs
- Identify and Prioritize R&D Needed for Future CO<sub>2</sub> Compressors

## Session 1.1



**Review of  
Workshop Objectives**  
Wolk



# **Workshop on Large Future CO2 Compression Systems**

**NIST  
March 30-31, 2009**

**Ron Wolk**

# Product of Prioritization Exercise

<b>R&amp;D Categories</b>	<b>Highest priority R&amp;D Project</b>					<b>Lowest Priority R&amp;D Project</b>
<b>Compression Systems Machinery and Components</b>	1	2	3	4	5	6
<b>Electric Drive Machinery</b>	1	2	3	4	5	6
<b>Drive Electronics and Components</b>	1	2	3	4	5	6
<b>Pipeline Issues</b>	1	2	3	4	5	6
<b>Integration of CO2 Capture and Compression</b>	1	2	3	4	5	6
<b>Properties of CO2 and Co-constituents</b>	1	2	3	4	5	6

# Product of Prioritization Exercise

<b>R&amp;D Categories</b>	<b>R&amp;D Project (“1” is highest priority)</b>
<b>Compression Systems Machinery and Components</b>	1
	2
	...
<b>Electric Drive Machinery</b>	1
	2
	...
<b>Drive Electronics and Components</b>	1
	2
	...
<b>Pipeline Issues</b>	1
	2
	...
<b>Integration of CO2 Capture and Compression</b>	1
	2
	...
<b>Properties of CO2 and Co-constituents</b>	1
	2
	...

# Proposed R&D Project Details

- **Title**
- **R&D Objective – experimental data, correlations, computational approaches, development and/or qualification of materials, component development, demonstration, field experience, etc.**
- **What is the desired result? – increased efficiency, reduced investment, reduced operating cost, reduced risk, etc.? By how much?**
- **Who will use the results? – researchers, designers, A&E's, operators, etc.**
- **How much will it cost?**
- **How long will it take?**

# Prioritization Process

- **During the discussion from 1-2 PM on Tuesday we will discuss the R&D topics suggested by the Workshop participants.**
- **We will display the suggestions on a screen visible to all by entering enter that information on the forms through a computer link.**
- **From 2-3 PM on Tuesday we will discuss the proposed R&D projects and then ask the participants to give us their priorities by voting on the forms during the discussion. Each Workshop participant will get ten votes to allocate. No more than three of those votes can be allocated to a single R&D project.**
- **After the meeting, I will sum the votes and provide a prioritized list of R&D topics to the Workshop participants to provide an opportunity for additional input. I will also try and summarize the votes by different interest groups – compressor machinery, electric drive, pipeline users, system integrators, A&E firms, researchers, etc., to determine if there is a difference of opinion based on background.**

# **Workshop Outputs**

- The authorized presentations will be posted on one or more publicly accessible websites**
- The prioritized results will be posted on the websites**
- A Proceedings of the Workshop will be prepared and distributed**



Keynotes

## Session 1.2 a

**Future Market Drivers  
for CO<sub>2</sub> Compression  
Equipment**  
Hattenbach



# Future Market Drivers for CO2 Compression Equipment

## Workshop on Future CO2 Compression Systems

Ray Hattenbach, VP  
Blue Source LLC  
March 30, 2009



**Blue Source**

# Key Driver

## Carbon Capture and Storage (CCS)



**Blue Source**

# Focus on Lowering CO<sub>2</sub> Emissions

- We Should Use and Develop!
  - Clean and Renewable Energy Sources
    - Wind
    - Solar
    - Nuclear
    - New Technologies (Tide / Wave ...)
  - Energy Efficiencies
    - Transportation – Improved Miles Per Gallon
    - Construction Methodology – Lower Energy Usage
      - HVAC / Lighting / Automation / Other Efficiencies
- But-Hydrocarbons are important to our economy TODAY and will be for some time in the Future!

# Where Our Energy Comes From!

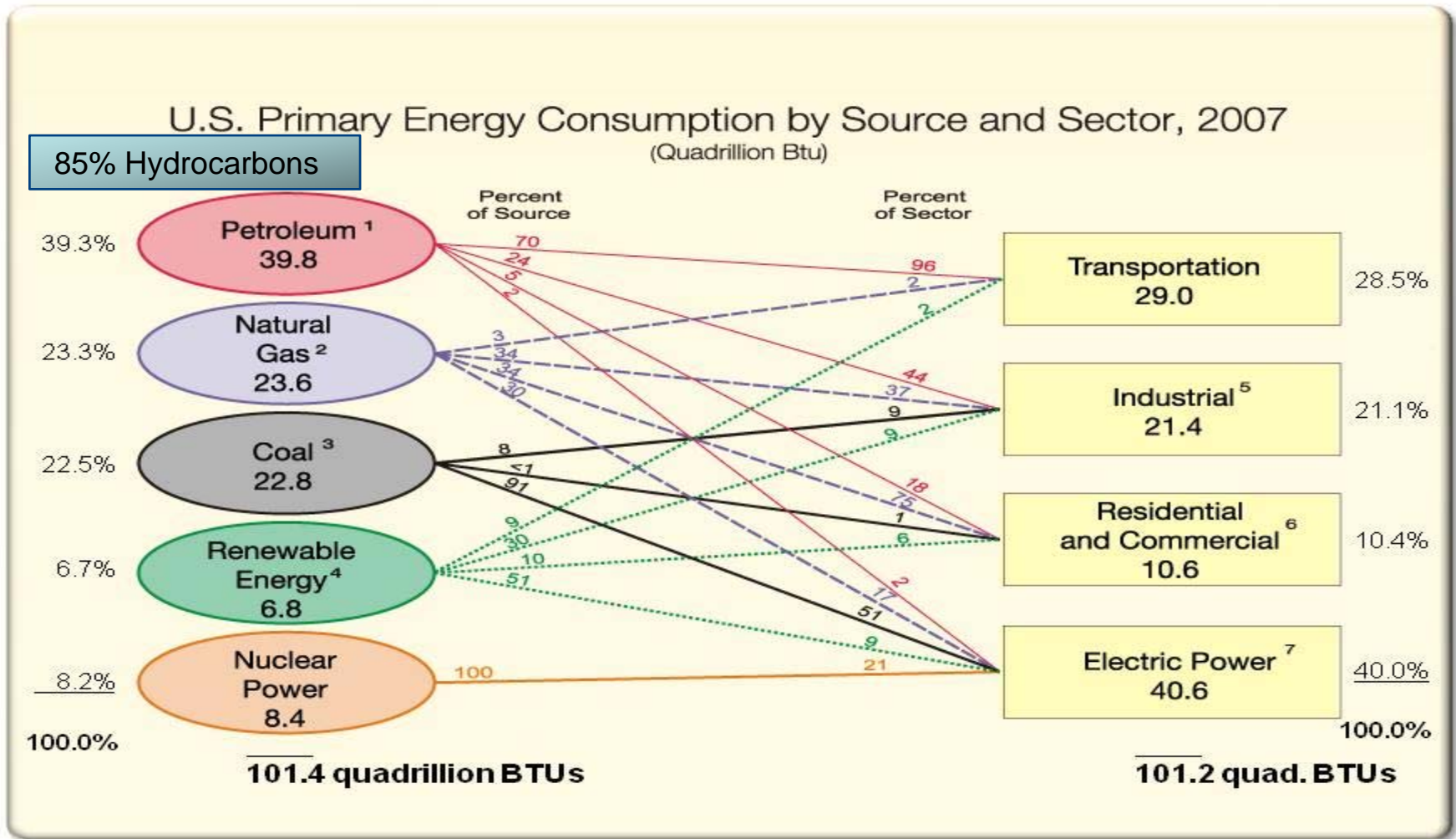

Source: US Department of Energy, Energy Information Administration (DOE/EIA)  
<http://www.eia.doe.gov/basics/energybasics101.html> From Perot Charts

# Lowering CO<sub>2</sub> Emissions

- If we want to significantly lower CO<sub>2</sub> emissions in the short term, CCS is a key component to the equation!
- CCS Options
  - Near Term Solution - EOR is **Now!!**
    - The U. S. needs the Oil!
    - Need to resolve issues relating to Liability & Pore Space
  - Long Term Solution - CCS
    - Depleted Hydrocarbon Reservoirs
    - Saline Aquifers (Issues: Liability & Pore Space Ownership)

# Why Promote CO<sub>2</sub>a in EOR?

- Infrastructure development
  - Existing 3,500 miles of CO<sub>2</sub> pipelines was built for EOR
  - Sunk assets will lower delivery cost and risk for CCS (depleted O&G reservoirs and aquifers)
- Environmental additionality
- Acceleration of CCS due to liability management, technology acceptance and economics as related to EOR

# What To Do?

- Provide Incentives for CCS Today
  - Federal / State / Industry
- EOR with CO<sub>2</sub> (anthropogenic) Leads
  - Lowers CO<sub>2</sub> emissions
  - Stores CO<sub>2</sub> in known geologic traps
  - Pays for pipeline infrastructure for future geological sequestration in non-hydrocarbon reservoirs
  - EOR with CO<sub>2</sub> does not create incremental Bbls
  - Maximizes the use of America's resources
  - Lowers Oil Imports
- Deep Saline Aquifers Follow
  - As Issues are resolved

# What Do We Need to Happen?

- Reasonable Rules and Regulations
  - CO<sub>2</sub> (anthropogenic) used for EOR should count as CCS
  - Proper characterization of CO<sub>2</sub>
    - It is a commodity for EOR!
    - Pollutant – No (EPA ?)
    - Hazardous Waste – No (EPA ?)
  - States should take the long term liability for storage – After proper injection and P&A
  - Clarification of pore space ownership
    - Storage Only
    - During EOR (mineral extraction) and After EOR (storage)
- Be proactive in sighting new facilities which can economically capture the CO<sub>2</sub>, such as gasification projects



# Carbon Infrastructure: Today and Tomorrow



**Blue Source**

# Overview of CO<sub>2</sub> Infrastructure in USA

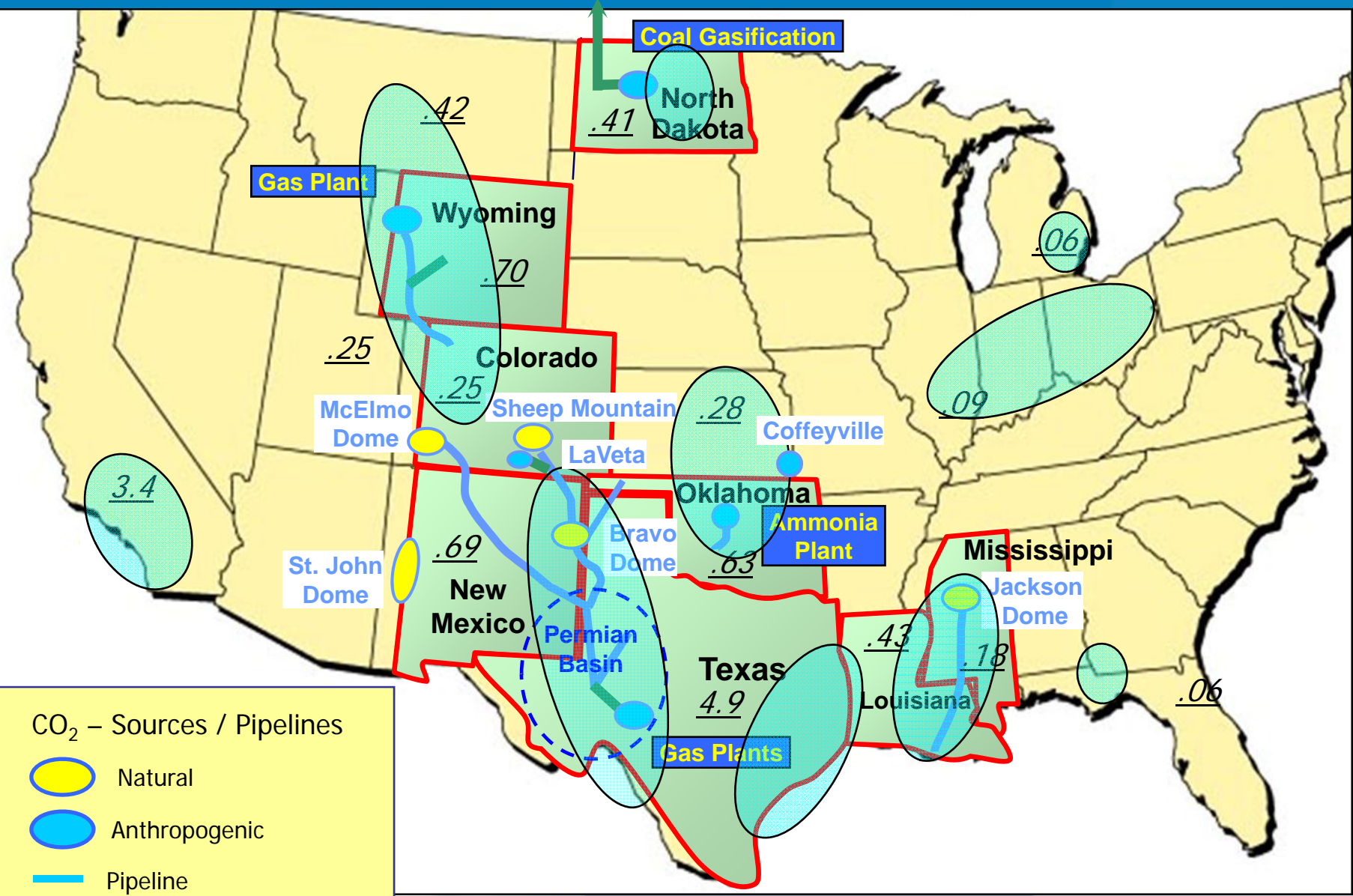

CO<sub>2</sub> – Sources / Pipelines

- Natural
- Anthropogenic
- Pipeline

10 Blue Source | A Leading Climate Change Portfolio

~~XX~~ Proved Oil Reserves (Billion Bbls) – EIA Data

# Anthropogenic Sources of CO<sub>2</sub>

## ■ High Purity

- Gas Processing
- Fertilizer
- Ethanol
- Hydrogen
- Gasification

## Low Purity

- Electrical Generation
  - Coal – 12% to 15%
  - Gas – 3% to 5%
- Cement – 12% - 15%

# High Purity Sources

- Generally 95%+ CO<sub>2</sub> – No Separation Cost
- Generally Low Pressure – High Cost to Compress
- Location to Sink – Aquifer or EOR
  - For EOR, need 25 to 50 MMcf/d + to lay pipeline 50 miles; as volume goes up so does distance for economic transport
  - For Saline Aquifer, long distances may be uneconomic
- What does that mean
  - Cost to Compress and Transport about 50 MMcf/d for 50 miles will cost \$1.30 to \$1.75/ Mcf or \$32.50 to \$33.70 /metric ton
    - Note: (These cost can vary significantly depending upon such things as power cost at certain locations, terrain to construct pipelines and many other factors.)

# Low Purity Sources

- **Generally less than 15% CO<sub>2</sub>**
  - Significant Separation Cost
  - Current Technology – Amine (Too Energy Intensive)
  - New Technology's – Chilled Ammonia? / Other  
Most likely 3-5+ Years Out
- Generally Low Pressure – High Cost to Compress
- Location to Sink – Critical for Aquifer or EOR

# Low Purity Sources

- ❑ For EOR, need 25 - 50 MMcf/d to lay 50 miles pipeline; as volume goes up so does distance
- ❑ For Saline Aquifer, longer distance is extra cost
- What does that mean
  - ❑ Cost to Capture, Compress and Transport about 50 MMcf/d for 50 miles will cost \$2.85 to \$4.00/ Mcf or \$55.00 to \$77.00/metric ton

Note: (These cost can vary significantly depending upon such things as local power cost, terrain to construct pipelines and many other factors.)

# Capture & Compression Costs for CO2a

- Recent Studies for CO2a Capture and Compression

	IGCC	SCPC	NGCC	PC-OxyFuel	
				New	Retro
• DOE/NETL*	\$39	\$68	\$83		
• Canada BERR*				\$48	\$67
• DOE (Trimeric)*		\$67			

\* 2007 Study

# Challenges

- Hydrocarbon Reservoirs
  - EOR requires High Purity CO<sub>2</sub> – 95% +
  - Need Significant Quantity > 25 MMcf/d / 1,300 metric tons/day
  - Needs to be relatively close to source – 1 to 2 miles for each 1 MMSCF/D
  - DOE Target of \$20/tonne for CO<sub>2</sub>a Capture
  - Cost Target for Capture & Compression (C&C)  
CO<sub>2</sub>a ~\$25-\$30/tonne (\$1.30-\$1.55/MSCF)



# Challenges

- Issues Emerging from Pending State Laws
  - CO<sub>2</sub>-EOR May Not Be Storage
  - Pore Space is Being Clarified “but”  
May Inhibit Oil & gas Operations in Storage Facilities
  - States Are Not Yet Willing to Accept Liability for Long Term Storage

# Conclusions

- For Non EOR Sequestration to Commence, US Industry Needs Visibility On
  - Value of Emission Reduction Credit
  - Regulations – Federal and State
    - Early Action Might be Penalized
    - Economic - Benefit or Cost?
  - Pore Space Ownership
  - Liability Issue
  - Cost for C&C of CO<sub>2</sub>a Needs to be Decreased

# Conclusions

- EOR Can and Is Happening Today
  - U. S. Infrastructure Backbone Can Be Built on the Back of Oil
  - High Purity Anthropogenic CO<sub>2</sub> Sources Can Lead the Way
  - Infrastructure Starts Out Regionally

# Questions!!



**Blue Source**

Session 1.2 b

**Introduction of Large Power  
Plants with CO<sub>2</sub> Capture  
and Compression**

Schoff



**EPRI**

ELECTRIC POWER  
RESEARCH INSTITUTE

# Introduction of Large Power Plants with CO<sub>2</sub> Capture and Compression

**DOE CO<sub>2</sub> Compression Workshop**  
Gaithersburg, MD

March 30, 2009

**Ronald L. Schoff**  
*Project Manager*  
*Advanced Generation & Industry Technology*  
*Demonstration Projects*

# EPRI Prism Analysis (2008 Revision)

## Technical Potential for CO<sub>2</sub> Reductions

*Achieving all targets is very aggressive, but potentially feasible.*

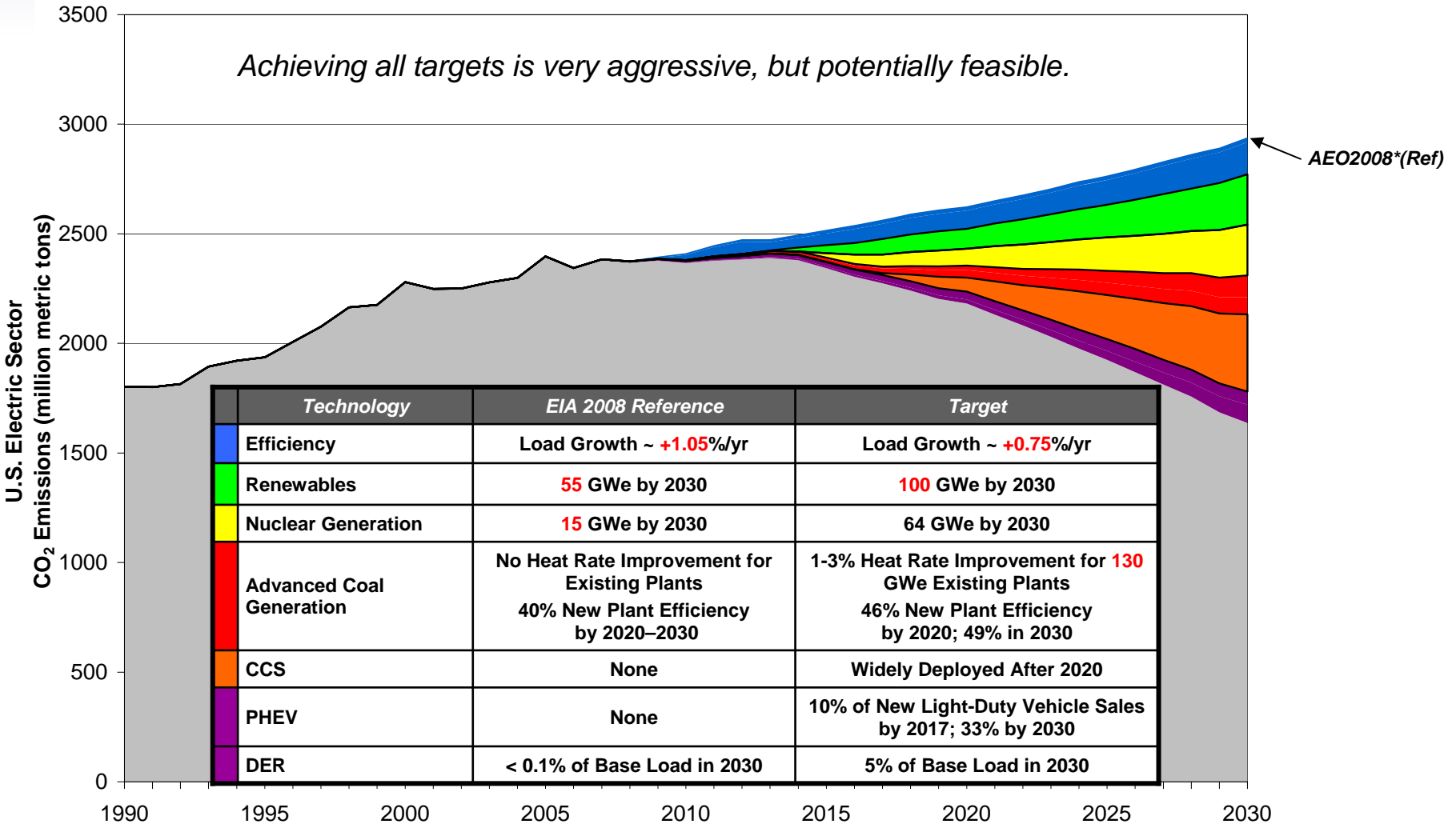

\*Energy Information Administration (EIA) Annual Energy Outlook (AEO)

# EPRI MERGE Analysis (2008 Revision)

## Increase in Real Electricity Prices...2000 to 2050

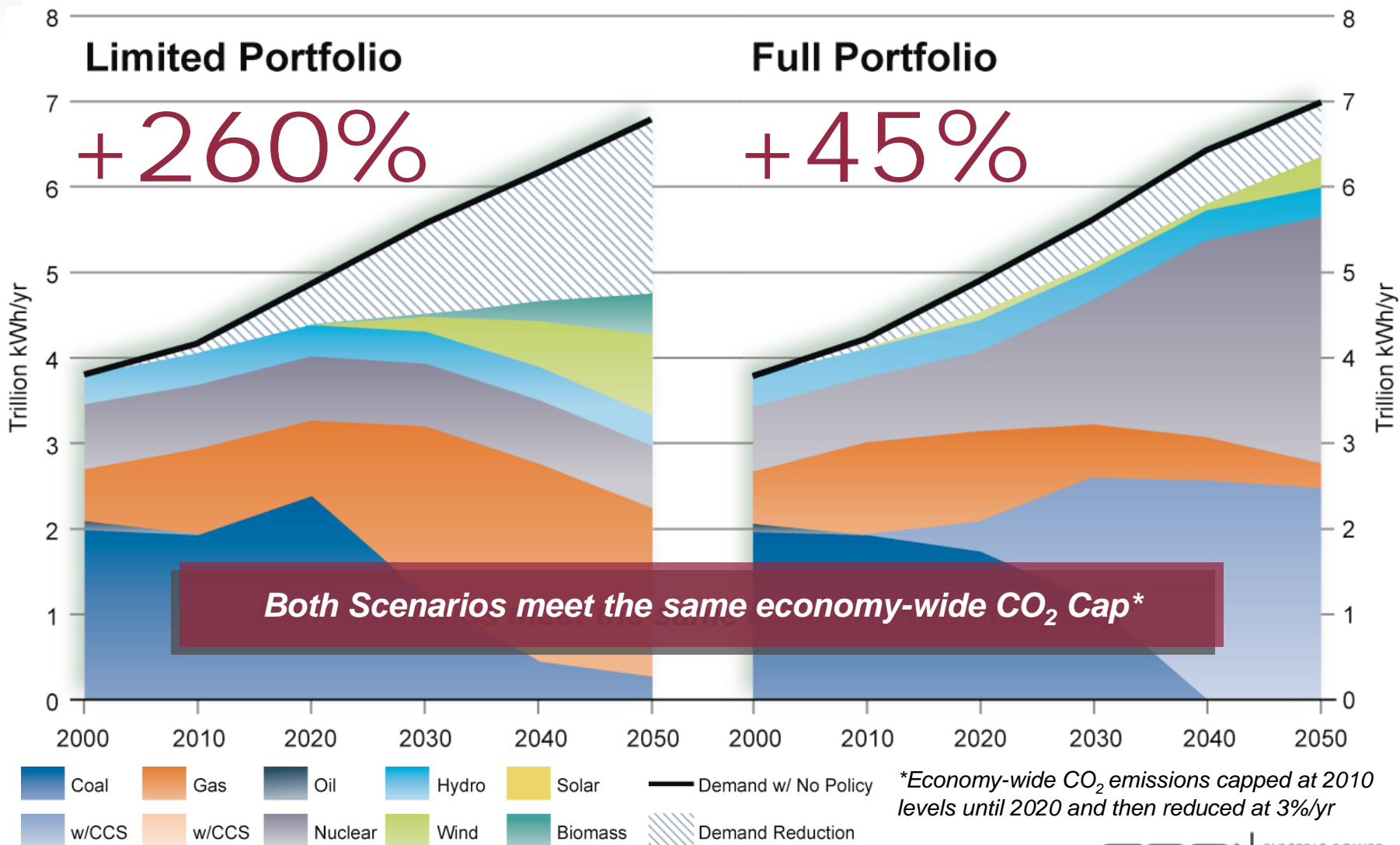



# Advanced Coal Plants with CCS

## Overview of Power & CO<sub>2</sub> Capture Technologies

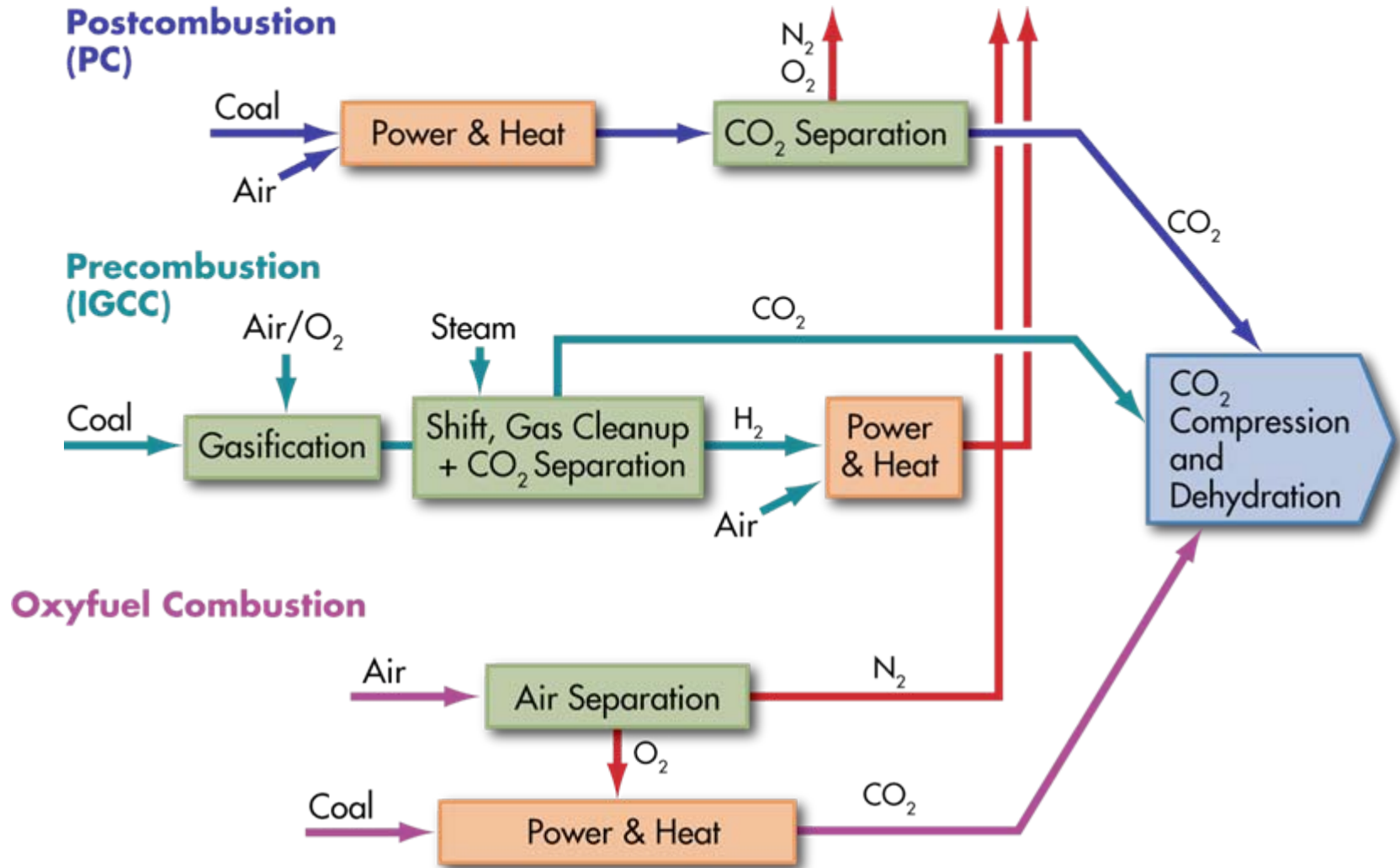

# Advanced Coal Plants with CCS

## Pulverized Coal w/CCS Process Flow Diagram

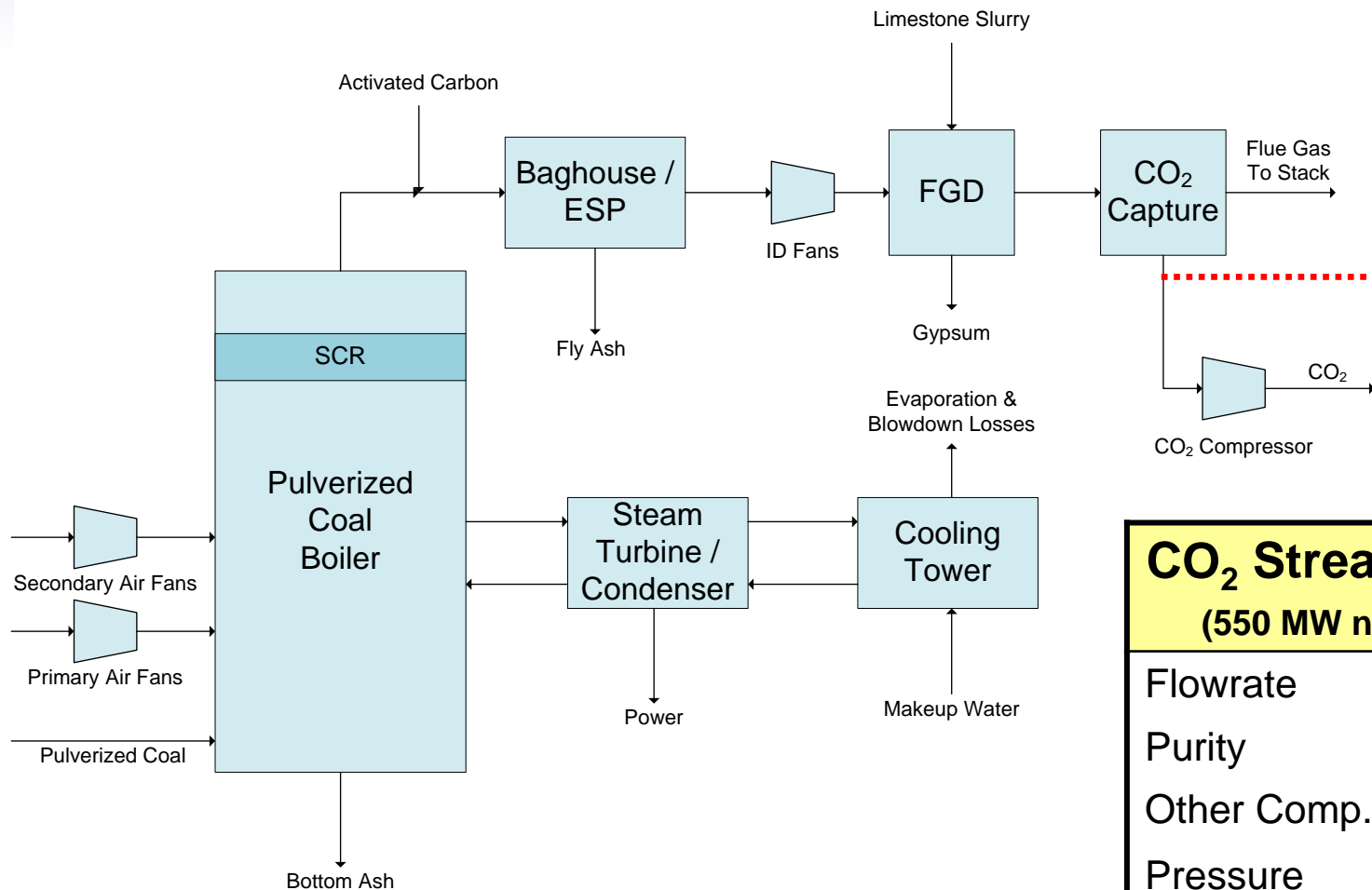

### CO<sub>2</sub> Stream Properties (550 MW net plant output)

Flowrate	15,000+ tpd
Purity	98%+
Other Comp.	O <sub>2</sub> , SO <sub>2</sub> , H <sub>2</sub> O
Pressure	15 to 25 psia
Temperature	~70°F

Data Source: NETL *Pulverized Coal OxyCombustion Plants*, August 2007

# Advanced Coal Plants with CCS

## *Pulverized Coal w/CCS Current Experience*

- **Three U.S. small plants in operation today**
  - Monoethanolamine (MEA)-based
- **CO<sub>2</sub> sold as a product or used**
  - Freezing chickens
  - Soda pop, baking soda
  - ~140 \$/ton CO<sub>2</sub>
- **300 metric tons recovered per day**
  - ~15-MWe power plant equivalent
- **Many pilots planned and in development**
  - 1.7-MWe chilled ammonia pilot (at right)
  - Many other processes under development



**PC + CO<sub>2</sub> Capture: Technology Exists but Larger-Scale Demonstrations & Less-Expensive Processes Needed**

# Advanced Coal Plants with CCS

## OxyFuel Combustion w/CCS Process Flow Diagram

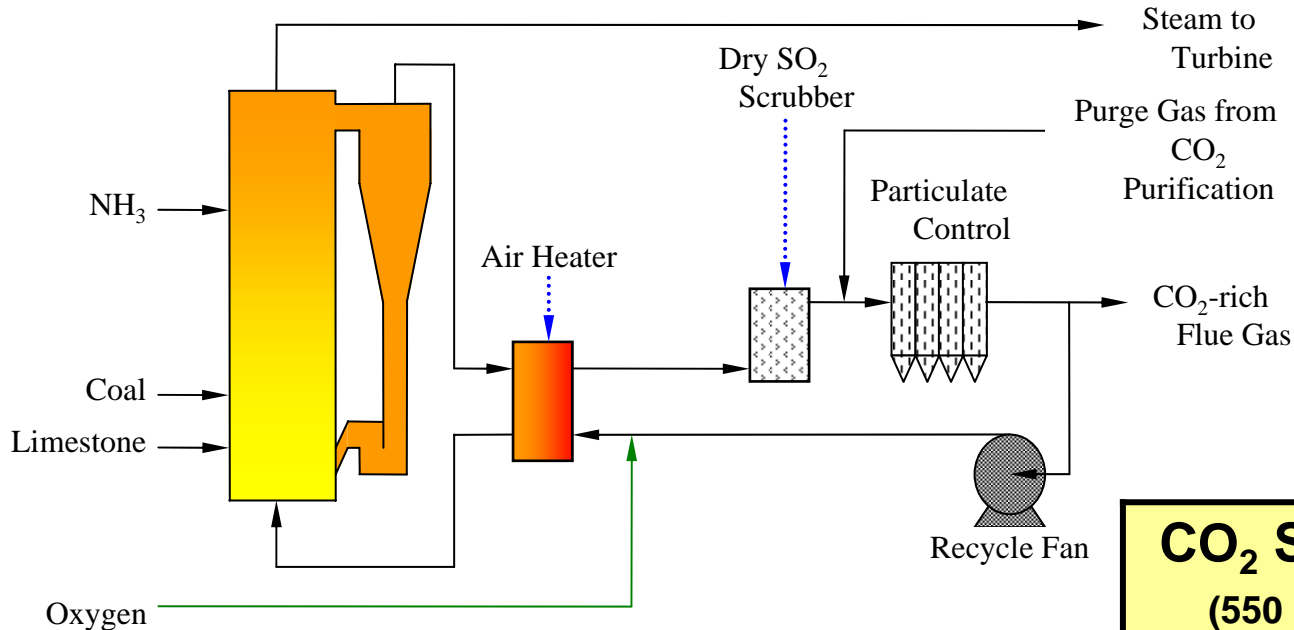

### CO<sub>2</sub> Stream Properties

(550 MWe net plant output)

Flowrate	18,000+ tpd
Purity	83 to 90%+
Other Comp.	Air, SO <sub>2</sub> , H <sub>2</sub> O
Pressure	<15 psia
Temperature	~80-100°F

Data Source: NETL *Pulverized Coal OxyCombustion Plants*, August 2007

# Advanced Coal Plants with CCS

## *OxyFuel w/CCS Current Experience*

### **No commercial power plants use oxy-combustion today, but:**

- Several pilot-scale (~1 MW) test units operating
- Vattenfall 30-MWth pilot plant under construction
- B&W 30-MWth test facility in Ohio

### **Significant design work under way:**

- Boiler design to limit air ingress and reduce flue gas recycle
- FGD for deeper sulfur removal
- Flue gas condensation for water separation from CO<sub>2</sub>
- CO<sub>2</sub> purification to limit amount of O<sub>2</sub>, N<sub>2</sub>, Ar, SO<sub>2</sub> and other constituents in the CO<sub>2</sub> product stream

**Technology under consideration for Greenfield and retrofit applications**

# Advanced Coal Plants with CCS

## IGCC w/CCS Process Flow Diagram

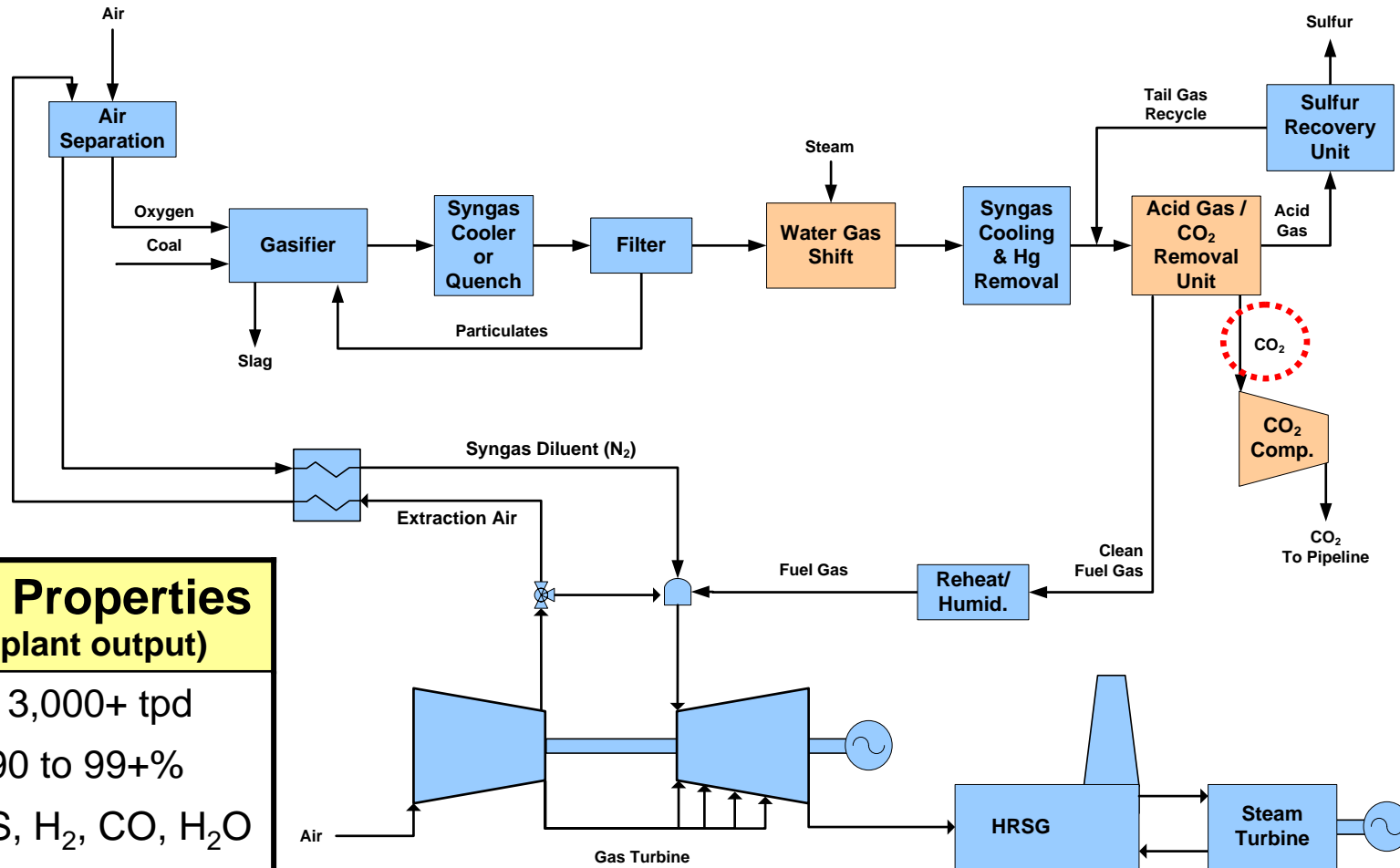

### CO<sub>2</sub> Stream Properties (550 MWe net plant output)

Flowrate	13,000+ tpd
Purity	90 to 99+%
Other Comp.	S, H <sub>2</sub> , CO, H <sub>2</sub> O
Pressure	15 to 300 psia
Temperature	~100°F

# Advanced Coal Plants with CCS

## *Gasification w/CCS operating experience*

- **IGCC and CO<sub>2</sub> removal offered commercially**
  - Have not operated in an integrated manner
- **Three U.S. non-power facilities and many plants in China recover CO<sub>2</sub>**
  - Coffeyville
  - Eastman
  - Great Plains
- **Great Plains recovered CO<sub>2</sub> used for EOR**
  - 2.7 million tons CO<sub>2</sub> per year
  - ~340 MWe if it were an IGCC
- **Several demonstrations and commercial projects in early development at present**

**IGCC + CO<sub>2</sub> capture – Ready for demonstration but need to lower costs**

# Advanced Coal Plants with CCS

## CO<sub>2</sub> Product Stream Compositions

	PC <sup>1</sup>	OxyFuel <sup>2</sup>	IGCC <sup>3</sup>
CO <sub>2</sub>	0.98	0.83	0.95 – 0.99+
Moisture	0.01	0.00	<1000 ppm
Total Sulfur (H <sub>2</sub> S, COS, SO <sub>2</sub> )	<0.01	0.01	50-1000 ppm
Combustibles (H <sub>2</sub> , CH <sub>4</sub> , CO, etc.)	0.00	0.00	0.05 – 0.02
Inerts (N <sub>2</sub> , Ar, etc.)	Trace	0.16	Trace
<b>Total</b>	<b>1.0</b>	<b>1.0</b>	<b>1.0</b>
<b>Flowrate (tpd)</b>	<b>10,000 - 20,000</b>		
<b>Pressure (psia)</b>	<b>15 – 30</b>	<b>Ambient</b>	<b>10 – 300</b>

- 1 – CO<sub>2</sub> capture system includes water wash and sulfur polishing
- 2 – Oxyfuel system includes flue gas condenser to remove water from CO<sub>2</sub>
- 3 – IGCC capture systems are flexible to meet required CO<sub>2</sub> specs

**CO<sub>2</sub> capture design may have a significant impact on design of compressors**



# Advanced Coal Plants with CCS

## CO<sub>2</sub> system chain of custody

- **CO<sub>2</sub> capture**
  - Plant design impacts
- **CO<sub>2</sub> compression**
  - In/out pressure, phase selection, reliability
- **Pipeline transport**
  - Metallurgy, venting?
- **CO<sub>2</sub> re-compression**
  - Number, design, other?
- **CO<sub>2</sub> injection**
  - Pressure, chemistry
- **CO<sub>2</sub> end-use**
  - Storage
  - EOR
  - Other

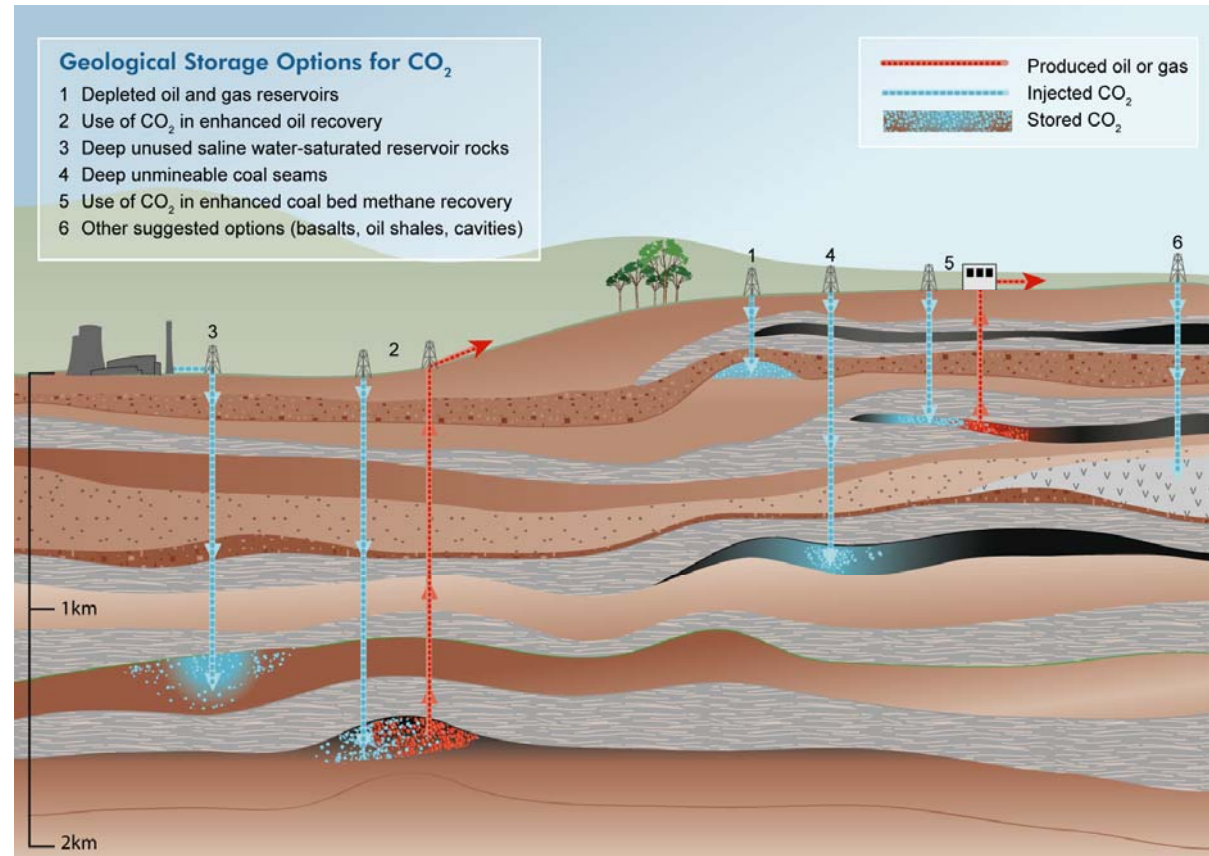

Courtesy of Peter Cook, CO2CRC

# What's Next – What's Needed for Coal?

- Acceleration of industry efforts worldwide in addition to governmental efforts
- Enhanced collaboration among industry, R&D and government
- Cost reductions and efficiency improvements for capture “systems”
- Large-scale testing of storage of CO<sub>2</sub> in deep saline reservoirs



# Discussion



## Session 2.0

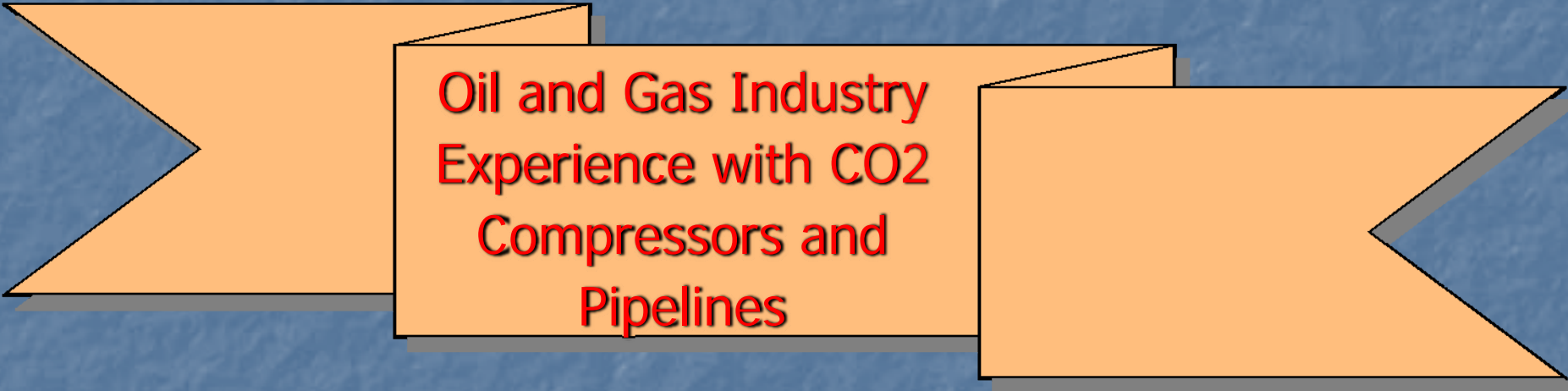

**Oil and Gas Industry  
Experience with CO<sub>2</sub>  
Compressors and  
Pipelines**

Session 2.1

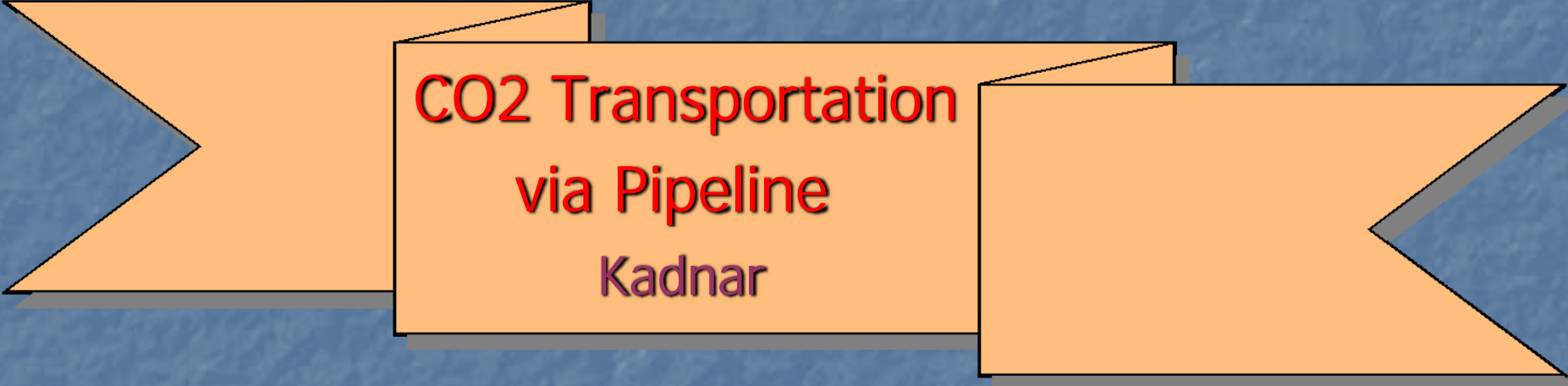

**CO2 Transportation  
via Pipeline**  
Kadnar

U.S. Department of Transportation

# CO<sub>2</sub> Transportation via Pipeline

Joy O. Kadnar

Pipeline & Hazardous Materials Safety  
Administration



Pipeline and Hazardous  
Materials Safety Administration

*... safe, reliable, and environmentally sound operation  
of the Nation's pipeline transportation system*

# Overall Message

- CO<sub>2</sub> pipelines are:
  - Well-established
  - Safe
    - Accident history is on par with other hazardous liquids pipelines
- Existing regulatory environment is satisfactory
- Pipeline operators know the hazards and manage their assets accordingly



# Background

- PHMSA
  - Hazardous materials transportation regulator
  - Extensive experience managing the risks of CO<sub>2</sub> in each of its physical states
  - Assures operators manage risk appropriately.
- Hazardous Materials Transportation Laws pertaining to CO<sub>2</sub>
  - 49 USC. 5101 et seq. and 49 USC 60101 et seq.
  - HazMat implementing regulations in 49 CFR Parts 171-180
  - Pipeline implementing regulations in 49 CFR Parts 190-199





# Regulatory Authority?

- Why does Part 195 apply to CO<sub>2</sub>?
  - Properties and characteristics
    - Can cause rapid suffocation
    - May cause nervous system damage, frostbite, dizziness and drowsiness
    - Self-contained breathing apparatus and protective clothing may be required by rescue workers



# PHMSA's Pipeline Safety Program

- Oversight shared with authorized state programs
- Other Federal and State agencies jointly make siting and permitting decisions
- 3,468 miles of CO<sub>2</sub> transmission pipelines
- Regional pipeline safety offices
  - # and staffing



Pipeline and Hazardous  
Materials Safety Administration

*... safe, reliable, and environmentally sound operation  
of the Nation's pipeline transportation system*

# What do Regulations Include?

- The hazardous liquid pipeline regulations include requirements for:
  - Pipeline design
  - Construction
  - Mapping
  - Operation and maintenance
  - Qualification of personnel
  - Incident reporting
  - Emergency response
  - Integrity Management



# CO<sub>2</sub> Pipeline Infrastructure

- 2007 Annual Reports
  - 3,468 miles
  - $\approx$  50 billion barrel-miles
  - Midwestern corridor



Pipeline and Hazardous  
Materials Safety Administration

*... safe, reliable, and environmentally sound operation  
of the Nation's pipeline transportation system*



U.S. Department of Transportation  
Pipeline and Hazardous Materials Safety Administration  
Projection: Albers Equal-Area Conic  
Map produced March 2009  
Source: National Pipeline Mapping System (NPMS), December 2008.

H:\Maps\Joy\National\_CO2



# Diameters vs. Mileages

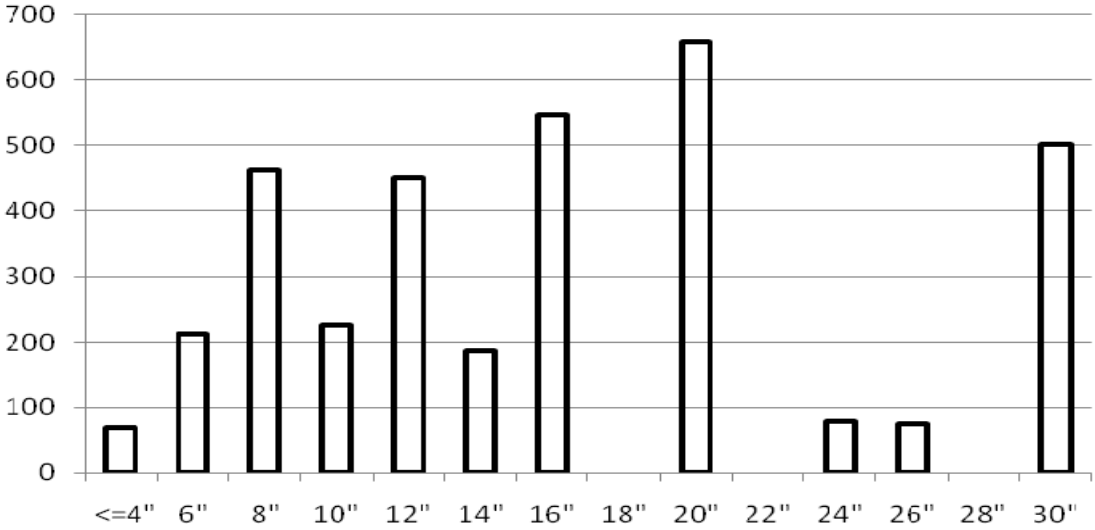
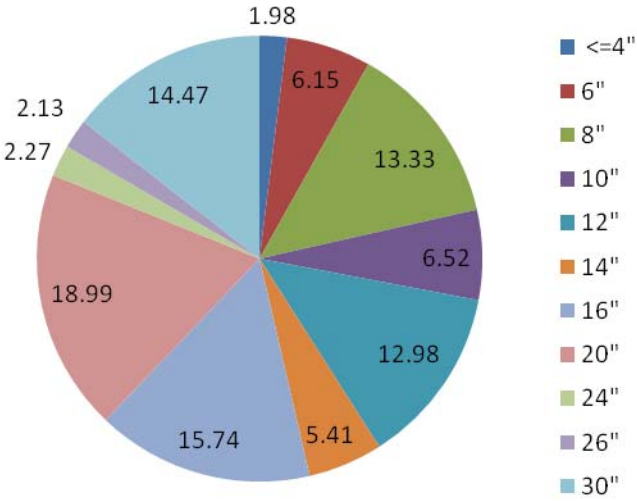

**Pipeline and Hazardous  
Materials Safety Administration**

*... safe, reliable, and environmentally sound operation  
of the Nation's pipeline transportation system*

# Age of Regulated Assets

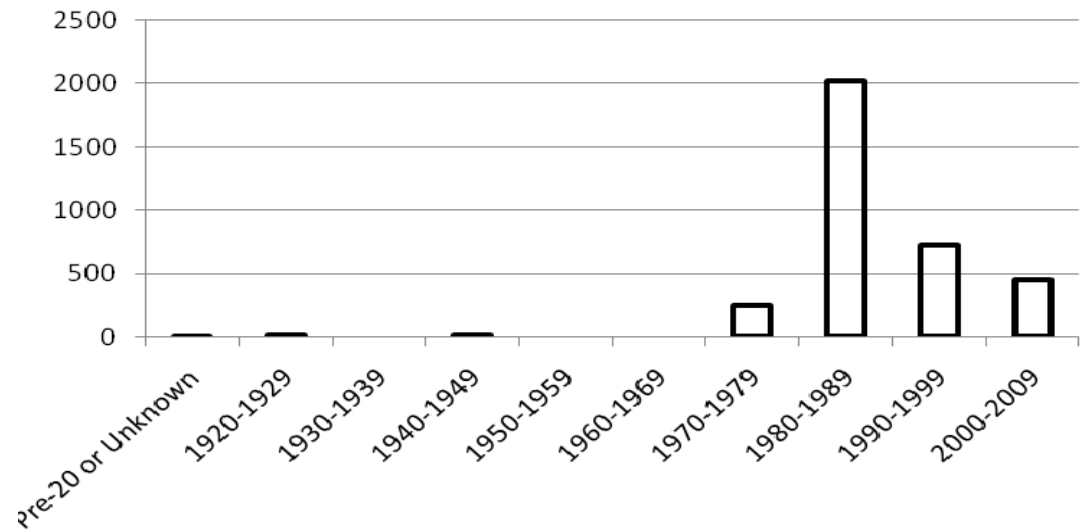
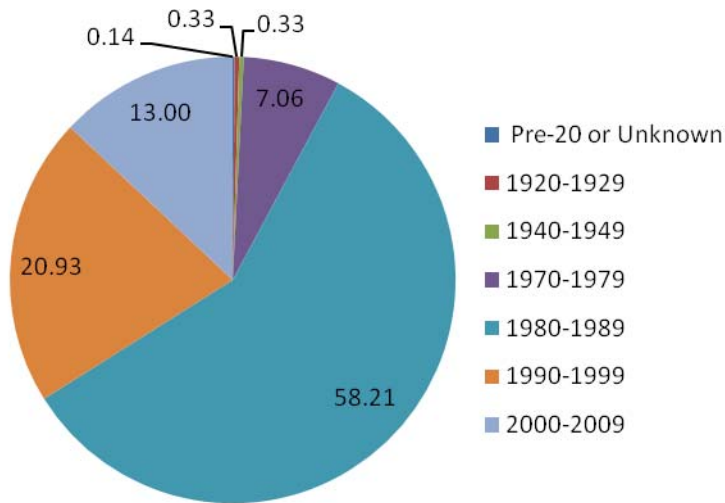

**Pipeline and Hazardous  
Materials Safety Administration**

*... safe, reliable, and environmentally sound operation  
of the Nation's pipeline transportation system*

# Failure Causes: 2004-07

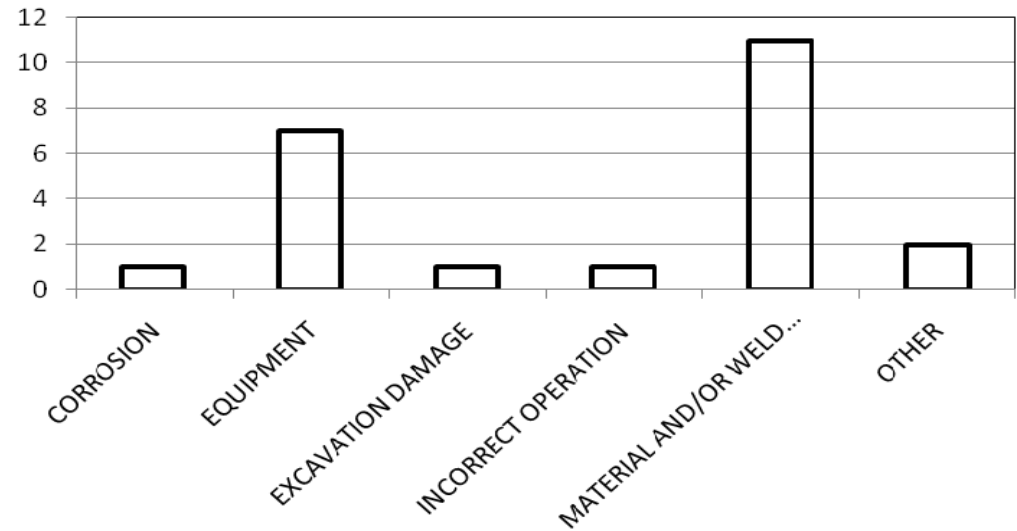
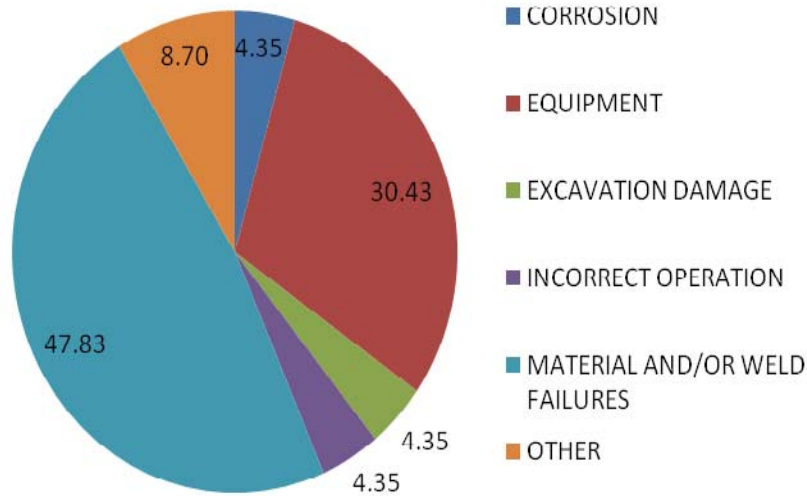

**Pipeline and Hazardous  
Materials Safety Administration**

*... safe, reliable, and environmentally sound operation  
of the Nation's pipeline transportation system*



# PEG

- PHMSA established new division
  - We will be looking at CO<sub>2</sub> as well as other pipelines using better data
  - This will provide improved information on risks to enable decisions on:
    - regulations, inspection program and enforcement



# Key Entities and Path Forward

- Federal Government—DOE, DOI, DOT and EPA
- States
- NASFM—First responders
- Pipeline siting models
  - CO<sub>2</sub>, oil, gas or hybrid?
  - DOT assistance through CATS



# Thank you

[joy.kadnar@dot.gov](mailto:joy.kadnar@dot.gov)



Pipeline and Hazardous  
Materials Safety Administration

*... safe, reliable, and environmentally sound operation  
of the Nation's pipeline transportation system*

# Abbreviations

- USC—United States Codes
- CFR—Code of Federal Regulations
- DOE—Department of Energy
- DOI—Department of Interior
- DOT—Department of Transportation
- EPA—Environmental Protection Agency
- NASFM—National Association of State Fire Marshals
- PEG—Program & Performance Evaluation Group
- CATS—Community Assistance & Technical Services



## Session 2.2

**Risk Aspects Related  
To Pipeline  
Transmission of CO<sub>2</sub>  
Bratfos**



# Risk Aspects Related to Pipeline Transmission of CO<sub>2</sub>



---

Workshop on Future Large CO<sub>2</sub> Compression Systems  
Gaithersburg March 30-31, 2009

Hans A. Bratfos, Head of Section, Cleaner Energy Norway  
DNV Energy

---

# What is this talk about?

## ■ Intro:

- About risk management
- About CCS
- About CO<sub>2</sub> pipeline transportation

## ■ Risk aspects

- Is CO<sub>2</sub> dangerous?
- Concerns about CO<sub>2</sub> transmission
- Dispersion assessments



- No risk – no business
- Risk Management is to:
  - Understand and control the risks
  - Take the right risks
  - Balance risk and reward for *all* stakeholders

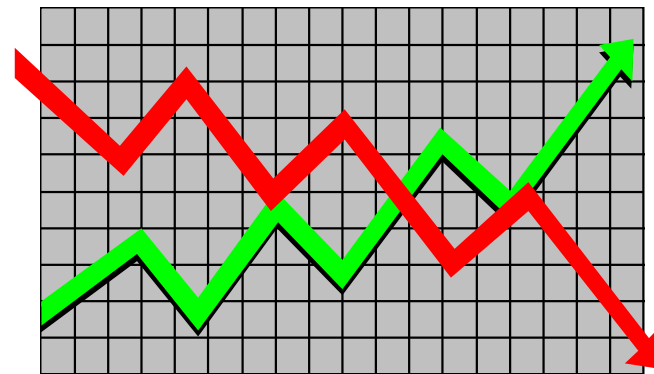

*Opportunities*

*Risks*



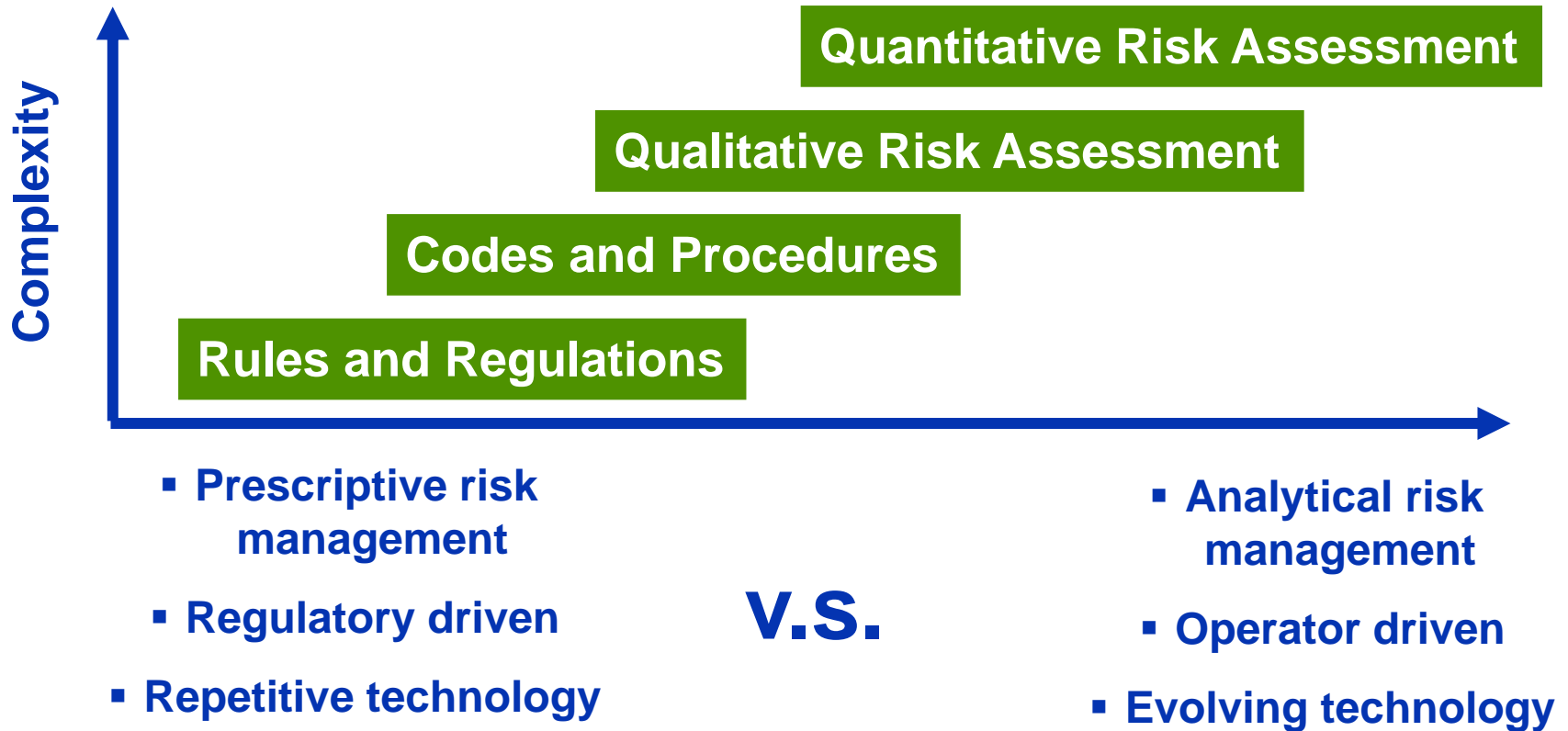

# The basic elements of risk assessment

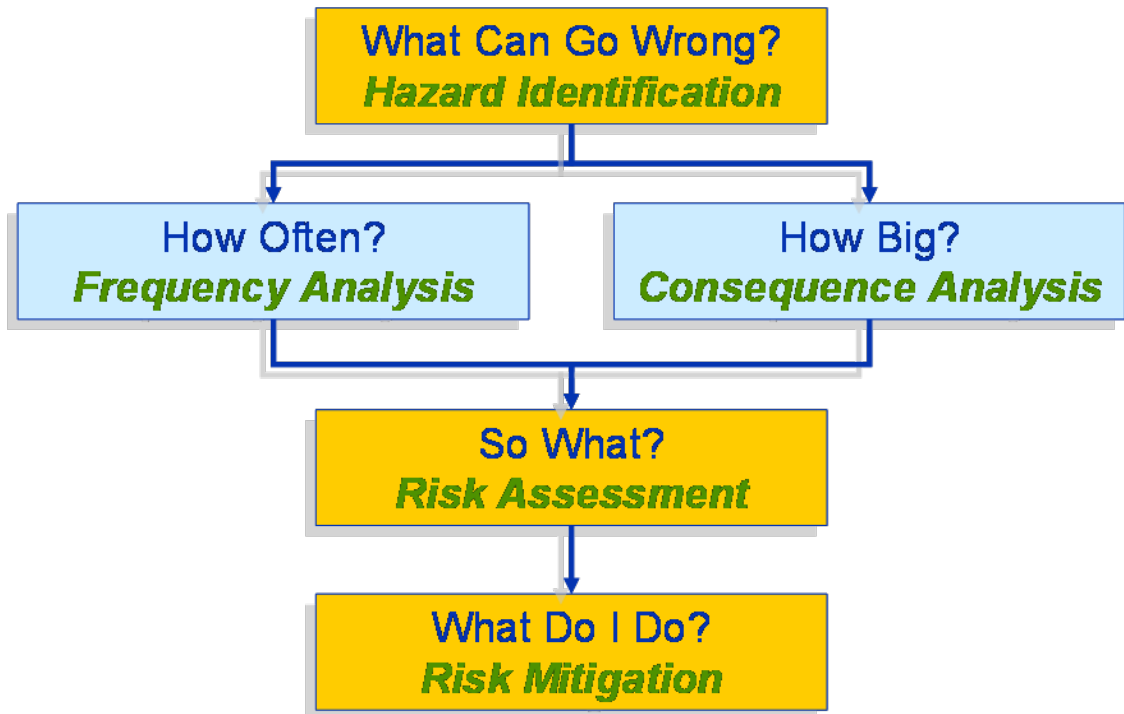

Consequence →

		1	2	3	4	5
		VERY LOW	LOW	MEDIUM	HIGH	VERY HIGH
Frequency ↑	5 VERY HIGH					
	4 HIGH					
	3 MEDIUM					
	2 LOW					
	1 VERY LOW					

Risk mitigation

- Political risks (incentives, future regulations, legal responsibilities)
- Commercial uncertainties (energy prices, value of CO<sub>2</sub>, land rights)
- Reliability (new technologies, different medium)
- Safety risks (releases and dispersion)
- Environmental risks (releases and dispersion)



- Risk acceptance involves a subjective balancing of benefits with risks.
- Two people who may agree on the degree of risk involved may disagree on its acceptability.
- *Environmental risks* are linked to consequences of significance to the nature and the people using it.
- *Environmental risk* is thus a public concern
- The public can not always see the benefits of taking the risks

# Two key challenges – for all of us



Need for energy



Climate change

# Carbon Capture and Storage – The solution?

MANAGING RISK



## Capture



- Fossil power plants
- Natural Gas CO<sub>2</sub> reduction
- Other industrial processes

## Transport



- Pipelines
- Ships

## Storage

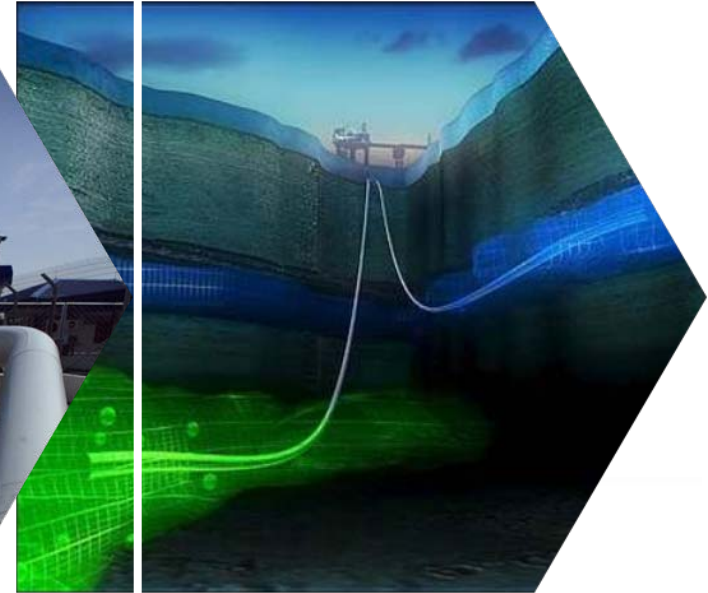

- Empty oil or gas reservoirs
- Saline aquifers
- Enhanced Oil Recovery

## CO<sub>2</sub> Sources & Storage Areas

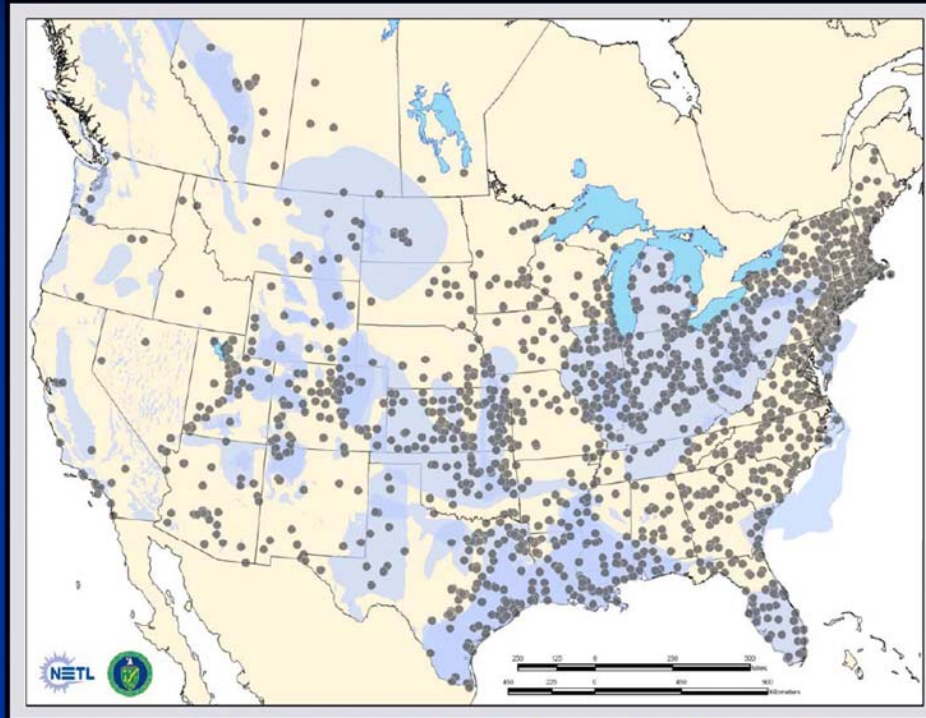

Image courtesy of Tim Carr, Natcarb Principal Investigator, DOE - NETL

8

- The CO<sub>2</sub> sources and sinks are not all in geographical proximity.
- The need for pipelines for CCS may therefore be considerable

# CO<sub>2</sub> pipelines – a booming industry?

Projected CO<sub>2</sub> emissions by 2030

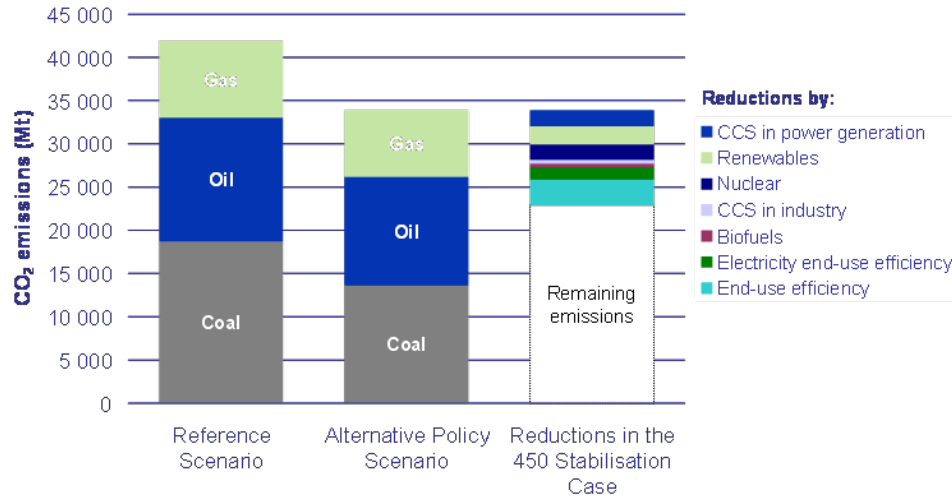

- IEA's proposed mix of means to stabilize the CO<sub>2</sub> concentration in the atmosphere to 450 ppm by 2030 includes 2.3 Gt/year by CCS

CO<sub>2</sub> captured by CCS by 2030 and projected demand for Natural Gas "450 Stabilisation Case"

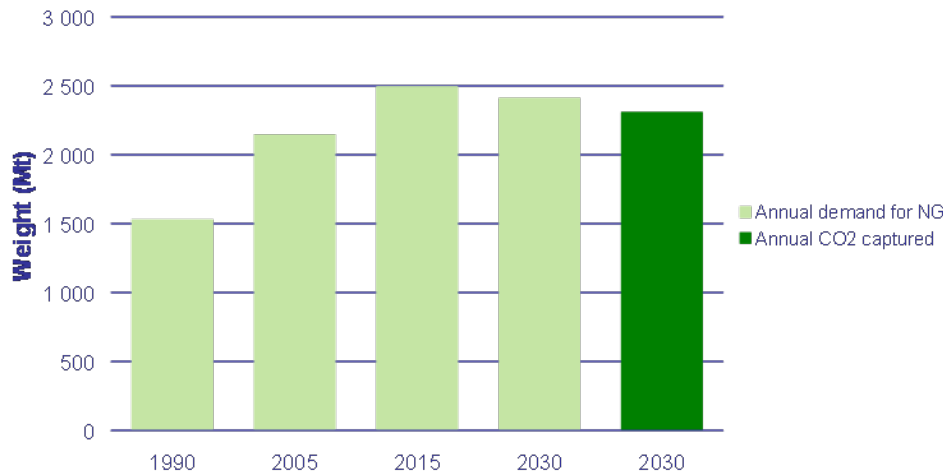

- This would imply that the future amount of captured CO<sub>2</sub> will be in the same order of magnitude as today's natural gas production



# CO<sub>2</sub> – A different risk exposure



- ☺ CO<sub>2</sub> is flammable
- ☺ CO<sub>2</sub> is not toxic in normal concentration
- ☺ A single CO<sub>2</sub> release has insignificant environmental impact

- ☹ Other chemical constituents (as H<sub>2</sub>S) carried in the CO<sub>2</sub> may harm people and the environment
- ☹ Concentrated CO<sub>2</sub> can displace oxygen and cause asphyxia
- ☹ Elevated CO<sub>2</sub> levels causes neurological effects ranging from flushed skin, muscle twitches and raised blood pressure to disorientation, convulsions, unconsciousness and death (IDLH<sup>1)</sup> level is set to 4%)
- ☹ CO<sub>2</sub> is heavier than air and may fill up sunken areas and confined spaces. Safety zones for NG can therefore not be adopted directly.



<sup>1)</sup> IDLH: “Immediately Dangerous to Life and Health”

# UK HSE Exposure Criteria

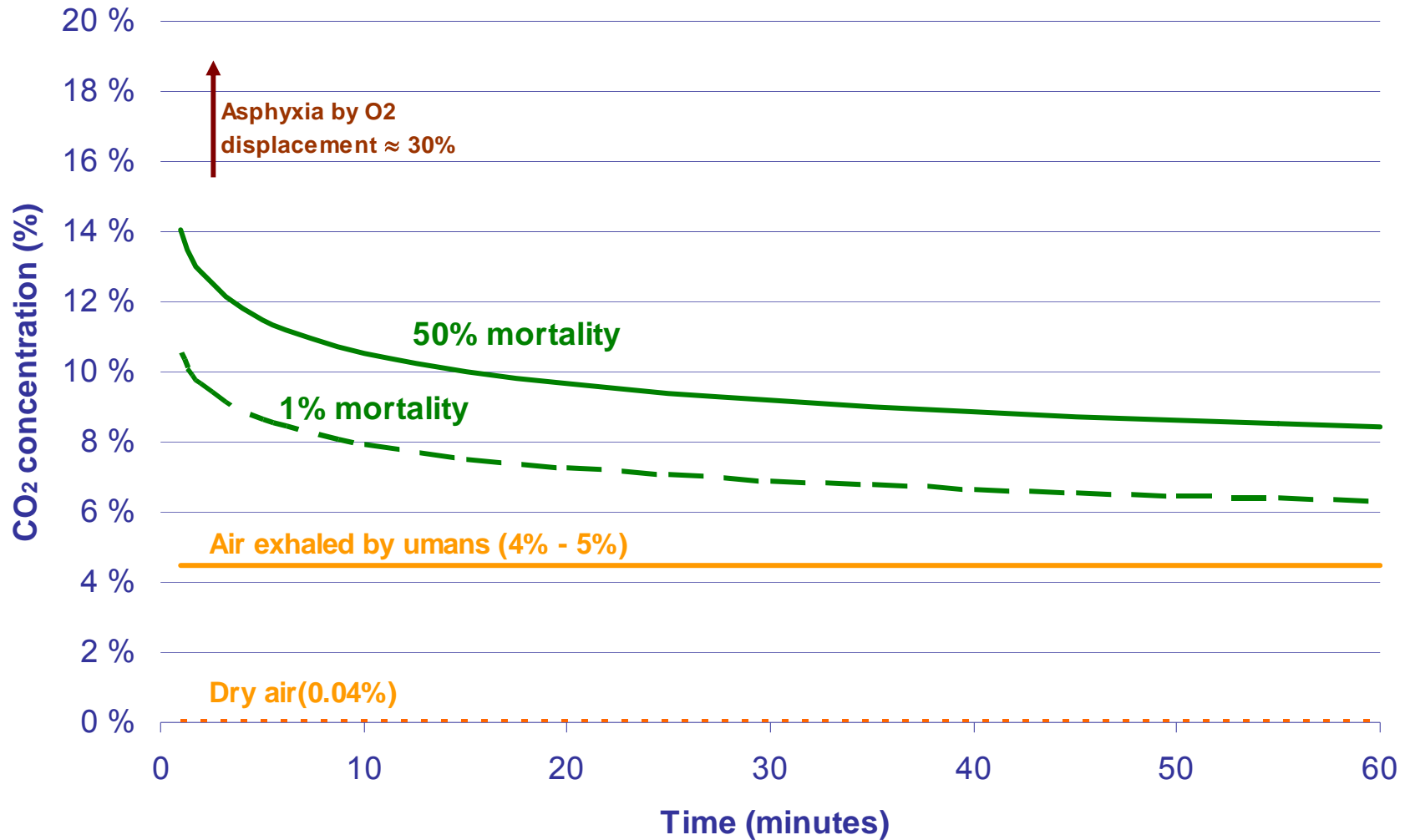

# CO<sub>2</sub> – An enhanced risk exposure

- The future CO<sub>2</sub> pipeline infrastructure may become several hundreds times larger than today.
- The CO<sub>2</sub> will be transported in highly concentrated form at high pressure (dense phase)

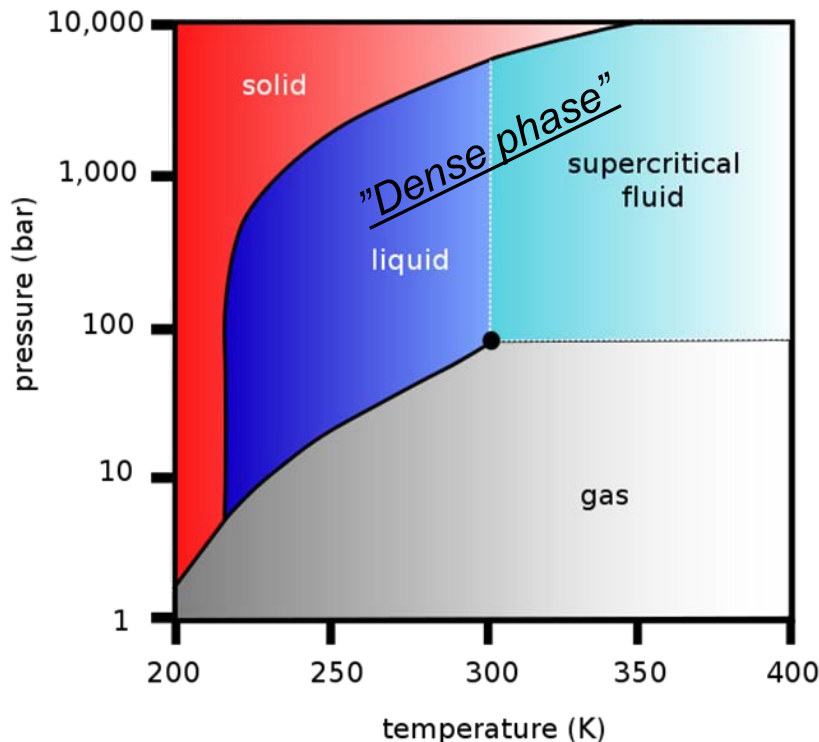

- The need to locate CHP coal power plants near consumers implies that CO<sub>2</sub> pipelines will pass through more densely populated areas
- Thus, large populations will be exposed to a risk, which for them will be perceived as *new*

## ***Root causes:***

- Emergency blowdown of large dense phase inventories
- Accidental denting
- CO<sub>2</sub> corrosion leaks in case of accidental intake of water
- Material compatibility (elastomers, polymers)
- Ductile fracture\_ (“un-zipping”)

## ***Consequences:***

- Dispersion of concentrated CO<sub>2</sub>
- Dispersion of toxic impurities
- Pipeline damage/downtime



- The incident rate for onshore natural gas pipelines is  $\approx 0.00008 \text{ km}^{-1} \text{ yr}^{-1}$  due to:
  - Corrosion (30%)
  - Third party (42%)
  - Design (7%)
  - Incorrect operation (13%)
  - Natural hazards (8%)
  
- The incident rate (from only 10 incidents) for CO<sub>2</sub> pipelines is  $\approx 0.00032 \text{ km}^{-1} \text{ yr}^{-1}$  due to:
  - Corrosion (20%)
  - Third party(10%)
  - Relief valve failure (40%)
  - Weld/gasket/valve packing failure (30%)

- CO<sub>2</sub> in free water phase creates carbonic acid ( $\text{CO}_2 + \text{H}_2\text{O} \rightleftharpoons \text{H}_2\text{CO}_3$ ) which is highly corrosive to C-Mn steels
- At high partial pressures of CO<sub>2</sub> the corrosion rates are expected to be dramatically higher than experienced for O&G pipelines
- We do not have models for predicting CO<sub>2</sub> corrosion rates which are valid for  $P > 10$  bar and  $T < 20^\circ\text{C}$
- Experimental data for high pressure CO<sub>2</sub> are few
- We have little insight in the effect of impurities  
Mixtures of CO<sub>2</sub> streams from different sources makes the picture complex.

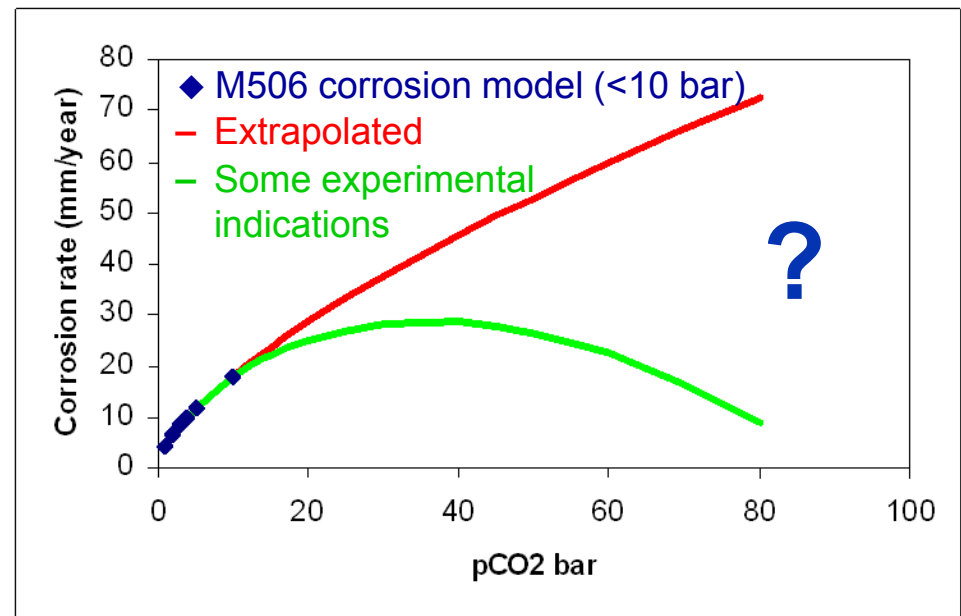

CO<sub>2</sub>PIPETRANS / IFE

- Design basis:  
Dehydration to ensure no formation of free water under any operational condition. (No corrosion allowance needed.)
  - What if an accidental intake of humidity?
    - Can the pipeline be considered undamaged if the situation is quickly restored to normal?
    - Should/can the pipeline be inspected for corrosion damage?
    - What kind of monitoring is required?
- ⇒ ***There is a need to understand more about corrosion rates in case of accidental intake of humidity***

- Today's software for release and dispersion analyses are incomplete with respect to CO<sub>2</sub>
  - Phase transformations directly between gas and solid (deposition/sublimation)
- The calculations models have not been sufficiently validated by large scale experiments
- Proper understanding of CO<sub>2</sub> dispersion is essential to setting safety zones (land sequestration) and determine insurance liability





# BP tests at Spadeadam in UK (DF1)



10% CO<sub>2</sub> Contours For 2" Release

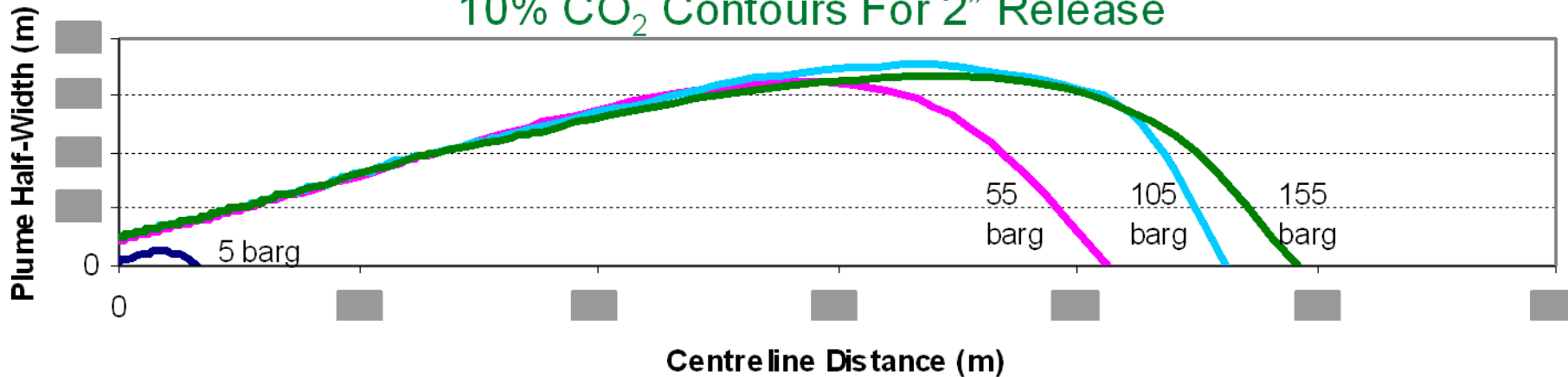

# Dispersion Modelling Examples (1)

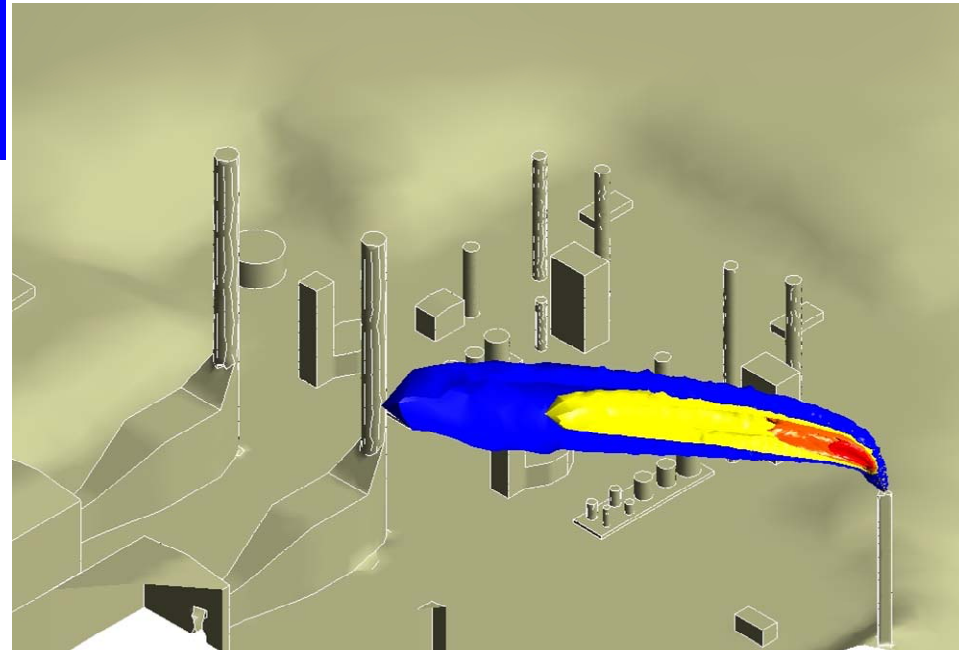
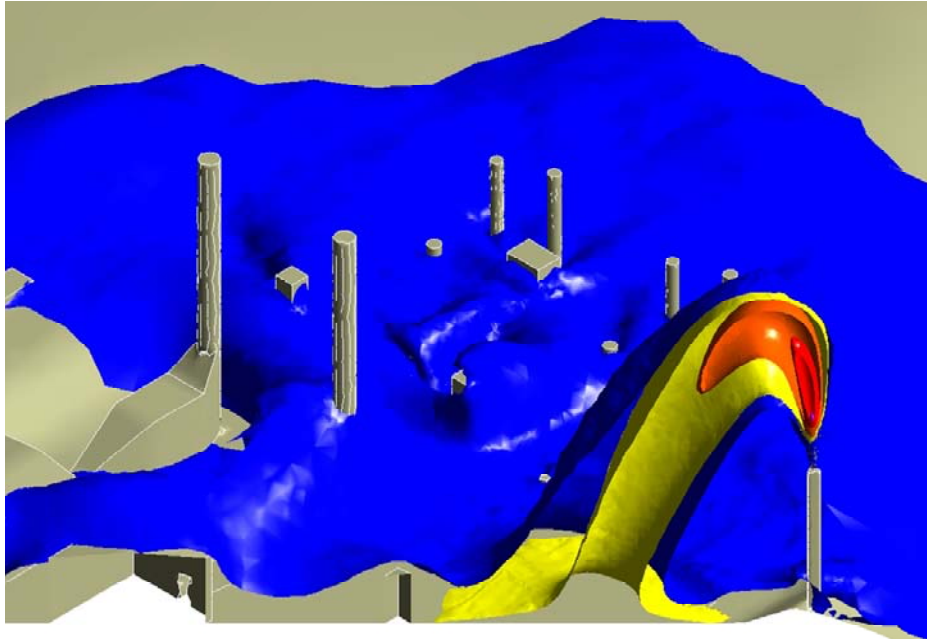

# Dispersion Modelling Examples (2)

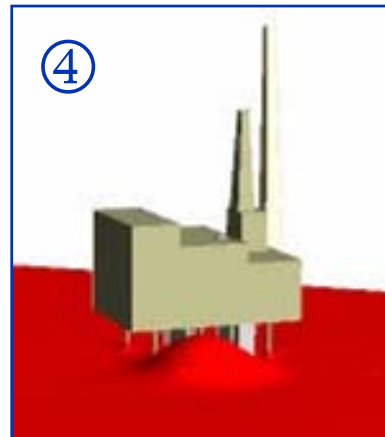
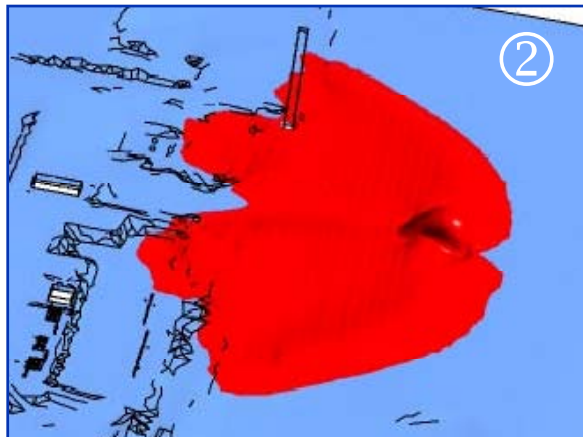
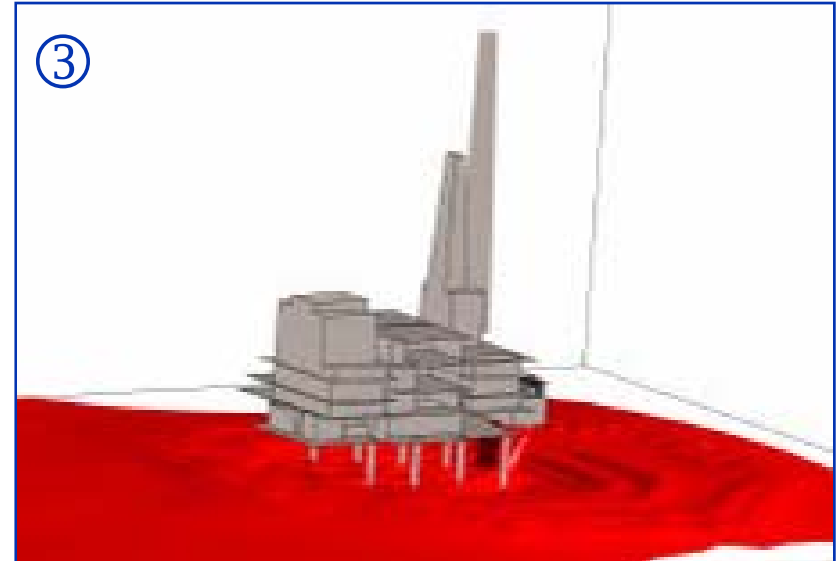
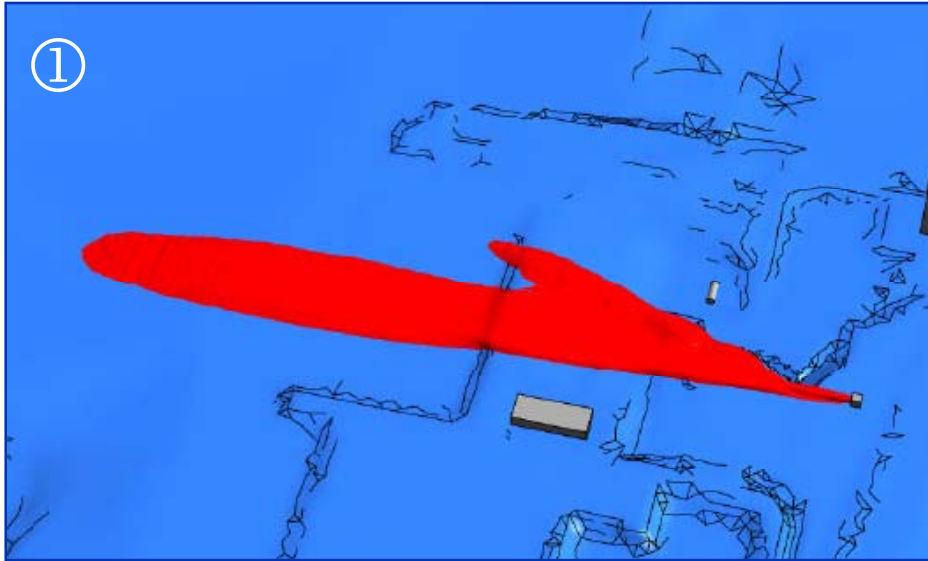

10% hazard range  
100 mm diameter pipeline  
150 barg pressure

- ① Onshore
- ② Underground
- ③ Underwater
- ④ Offshore platform

# Dispersion Modelling Examples (3)

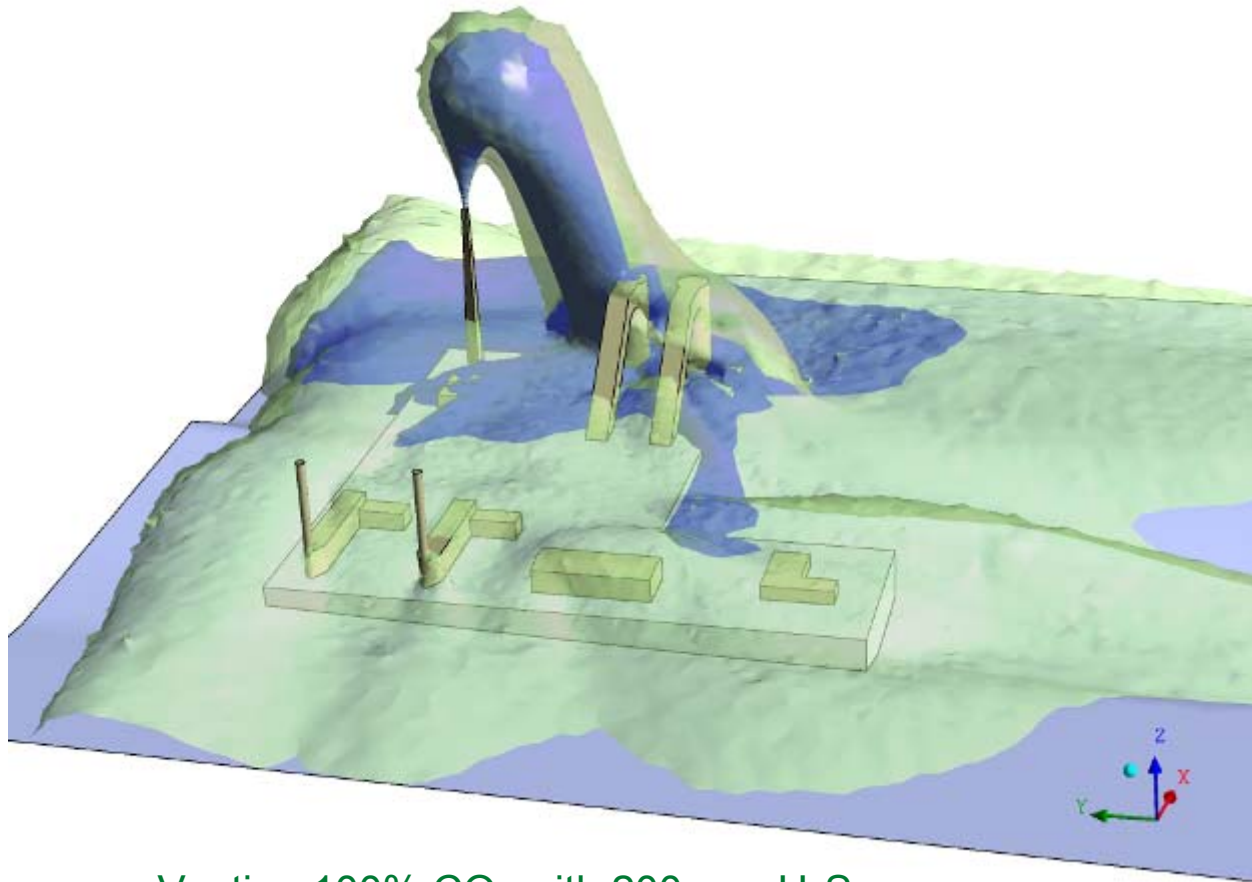

Venting 100% CO<sub>2</sub> with 200ppm H<sub>2</sub>S  
at 416 tonnes/hr (10,000 Tonnes/day)  
through 36" vent with 0.5m/s wind.  
Blue isosurface = 0.5% CO<sub>2</sub> (LTEL)  
Green isosurface = 13ppm H<sub>2</sub>S (odour threshold)

# Approach:

## Recommended Practice for design of CO<sub>2</sub> pipelines

MANAGING RISK



- Existing pipeline design codes do not adequately address issues which are specific to CO<sub>2</sub> transmission
- DNV is developing a Recommended Practice (RP) for transportation of dense phase CO<sub>2</sub>. together with 12 industry partners
- The RP will supplement current design codes such as ASME B31.8, ISO 13623, DNV OS-F101, API RP1111, BSI PD 8010, EN 14161, EN-1594.
- Phase 1:
  - A guideline incorporating current knowledge
  - To be issued in 2009
- Phase 2:
  - Investigations into selected knowledge gaps
  - A revised guideline within 2 – 3 years

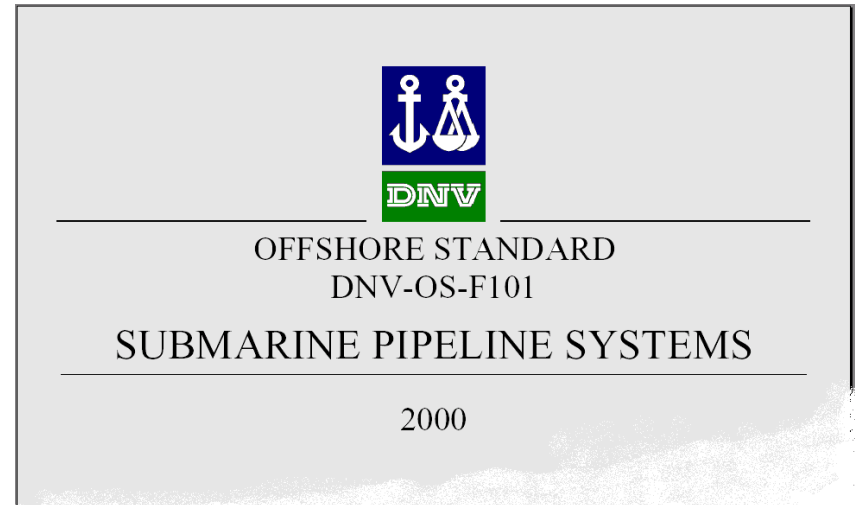

- No risk – no business ...
- ... but risks have to be managed!



*Thank you !*



[www.dnv.com](http://www.dnv.com)

---

## Session 2.3

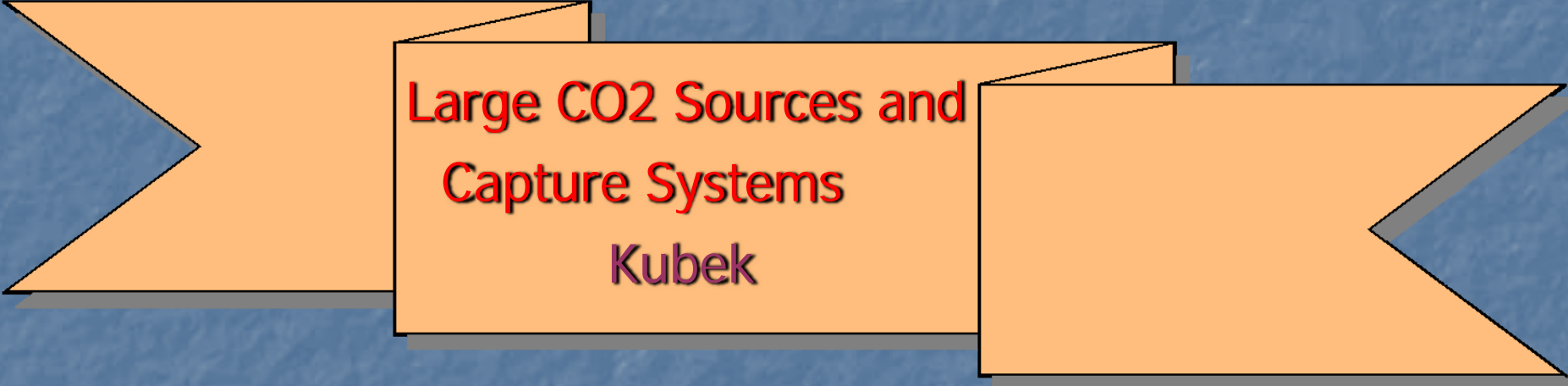

# Large CO<sub>2</sub> Sources and Capture Systems

Kubek



# Workshop on Future Large CO2 Compression Systems

Gaithersburg, MD  
March 30, 2009

Sponsored by EPRI / DOE / NIST

## Large CO2 Sources & Capture Systems

Gas Processing Solutions LLC

Dan Kubek

Dan.Kubek@Yahoo.com



# Workshop on Future Large CO2 Compression Systems

## Large CO2 Source & Capture Systems

### Agenda

- **CO2 Pipelines in USA for EOR**
- **3 Large CO2 Source/Capture/Compression Plants**
  - ExxonMobil LaBarge-Shute Creek, WY Natural Gas Plant
  - CDT Inc / Lubbock, TX CO2-from-CFPP-Flue Gas
  - Coffeyville Resources (KS) Gasification-based Fertilizer Plant



# CO<sub>2</sub> Pipelines in USA for EOR (Enhanced Oil Recovery)



# Major CO2 Pipelines in USA for EOR

Source: Melzer Consulting / 6th Annual Conference  
CC&S Conf-Pittsburgh / 10May2007

The Major* North American CO <sub>2</sub> Pipelines								
Ref: Melzer Consulting '07								
PIPELINE	Owner/Operator	Length (mi)	Length (km)	Diameter - in	Estimated Max Flow	Estimated Max Flow	Location	PL Type
					Capacity (mmcfpd)	Capacity (million tons/yr)		
Adair	Apache	15	24	4	47	1.0	TX	II
Anadarko Powder River Basin CO2 PL	Anadarko	125	201	16	204	4.3	WY	II
Anton Irish	Oxy	40	64	8	77	1.6	TX	II
Bravo	Oxy Permian	218	351	20	331	7.0	NM, TX	II
Canyon Reef Carriers	Kinder Morgan	139	224	16	204	4.3	TX	II
Centerline	Kinder Morgan	113	182	16	204	4.3	TX	II
Central Basin	Kinder Morgan	143	230	16	204	4.3	TX	II
Chaparral	Chaparral Energy	23	37	6	60	1.3	OK	II
Choctaw	Denbury Resources	183	294	20	331	7.0	MS, LA	II
Comanche Creek (2007 reactivated)	PetroSource	100	161	6	60	1.3	TX	II
Cordona Lake	XTO	7	11	6	60	1.3	TX	II
Cortez	Kinder Morgan	502	808	30	1117	23.6	TX	II
Dollarhide	Chevron	23	37	8	77	1.6	TX	II
El Mar	Kinder Morgan	35	56	6	60	1.3	TX	II
Enid-Purdy (Central Oklahoma)	Anadarko	117	188	8	77	1.6	OK	II
Este I - to Welch, Tx	ExxonMobil, et al	40	64	14	160	3.4	TX	II
Este II - to Salt Crk Field	ExxonMobil	45	72	12	125	2.6	TX	II
Ford	Kinder Morgan	12	19	4	47	1.0	TX	II
Joffre Viking	Penn West Petroleum Ltd	8	13	6	60	1.3	Alberta	II
Llano	Trinity CO2	53	85	12-8	77	1.6	NM	II
Pecos County	Kinder Morgan	26	42	8	77	1.6	TX	II
Raven Ridge	Chevron	160	257	16	204	4.3	WY/Co	II
Sheep Mtn	British Petroleum	408	656	24	538	11.4	TX	II
Shute Creek	ExxonMobil	30	48	30	1117	23.6	WY	II
Slaughter	Oxy Permian	35	56	12	125	2.6	TX	II
Transpetco	TransPetco	110	177	8	77	1.6	TX, OK	II
W. Texas	Trinity CO2	60	97	12-8	77	1.6	TX, NM	II
Wellman	PetroSource	25	40	6	60	1.3	TX	II
White Frost	Core Energy, LLC	11	18	6	60	1.3	MI	II
Wyoming CO2	ExxonMobil	112	180	20-16	204	4.3	WY	II
Dakota Gasification (Souris Valley)	Dakota Gasification	204	328	16	204	4.3	ND/Sask	III
Pikes Peak	PetroSource	40	64	8	77	1.6	TX	III
Val Verde	PetroSource	83	134	10	98	2.1	TX	III
Totals:		3,245	5,221					

\* Tabulation does not include many shorter high pressure trunk lines to individual fields

600 MW- IGCC @ 90% CO2 Capture = 4.3 MM T/Y CO2



# CO2 Pipelines in USA for EOR

Source: Polytec (Norway) / 08January2008

## State-of-Art Overview / CO2 Pipeline Transport

Table 5-1: CO<sub>2</sub> composition transported in existing pipelines (given as vol% if not stated otherwise)

	Canyon Reef Carriers (4)	Central Basin Pipeline (5)	Sheep Mountain (6) (7; 8)	Bravo Dome Source (9)	Cortez Pipeline (10)	Weyburn (11)	Jackson Dome, NEJD
CO <sub>2</sub>	85-98	98.5	96.8-97.4	99.7	95	96	98.7-99.4
CH <sub>4</sub>	2-15	0.2	1.7	-	1-5	0.7	Trace
	C6H14						
N <sub>2</sub>	<0.5	1.3	0.6-0.9	0.3	4	<300 ppm	Trace
H <sub>2</sub> S	<200 ppm	< 20 ppm (spec)	--	-	0.002	0.9	Trace
C2+		-	0.3-0.6	-	Trace	2.3	-
CO	-	-	-	-	-	0.1	-
O <sub>2</sub>	-	<10 ppm wt (spec)	-	-	-	<50 ppm wt	-
NO <sub>x</sub>	-	-	-	-	-		-
SO <sub>x</sub>	-	-	-	-	-		-
H <sub>2</sub>	-	-	-	-	-	Trace?	-
Ar	-	-	-	-	-		-
H <sub>2</sub> O	50 ppm wt	257 ppm wt	129 ppm wt	-	257 ppm wt	20 ppm vol	-

# Workshop on Future Large CO2 Compression Systems

## Large CO2 Source & Capture Systems

### Agenda

- CO2 Pipelines in USA for EOR
- 3 Large CO2 Source/Capture/Compression Plants
  - ExxonMobil LaBarge-Shute Creek, WY Natural Gas Plant
  - CDT Inc / Lubbock, TX CO2-from-CFPP-Flue Gas
  - Coffeyville Resources (KS) Gasification-based Fertilizer Plant



# ExxonMobil Shute Creek NG Plant CO2 Capture & Compression for EOR Shute Creek, WY NG Treating Facility



ExxonMobil -- Shute Creek, WY Gas Treating Facility

Source: EXOM – Midland CO2 Conference / 2005

# ExxonMobil Shute Creek Natural Gas (NG) Plant CO<sub>2</sub> Capture & Compression for EOR Gas Processing Overview

- LaBarge NG Field & Shute Creek Gas Treating Facility
- Commissioned in 1986 in SW-Wyoming
  - Initial Capacity of 480 MMSCFD of NG
  - Expanded in 2005 to 700 MMSCFD
- NG Feed: 5%V H<sub>2</sub>S – 66%V CO<sub>2</sub> – 21%V CH<sub>4</sub> – 0.6%V He – 7%V N<sub>2</sub>
- Marketable Products: CH<sub>4</sub>, CO<sub>2</sub>, He, & Sulfur
- Selexol Process (2-trains) used for Acid Gas Removal:
  - H<sub>2</sub>S-Rich Acid Gas (65 MMSCFD H<sub>2</sub>S & 25 MMSCFD CO<sub>2</sub>)
    - Originally sent to Claus-SRU for Elemental Sulfur
    - Now Compressed, Liquified, and Pumped into Formation
    - Largest-known Facility for AG-Injection in Operation
  - CO<sub>2</sub> for Compression to Pipeline for EOR Fields



# ExxonMobil LaBarge / Shute Creek Facilities Overall Block Flow Diagram

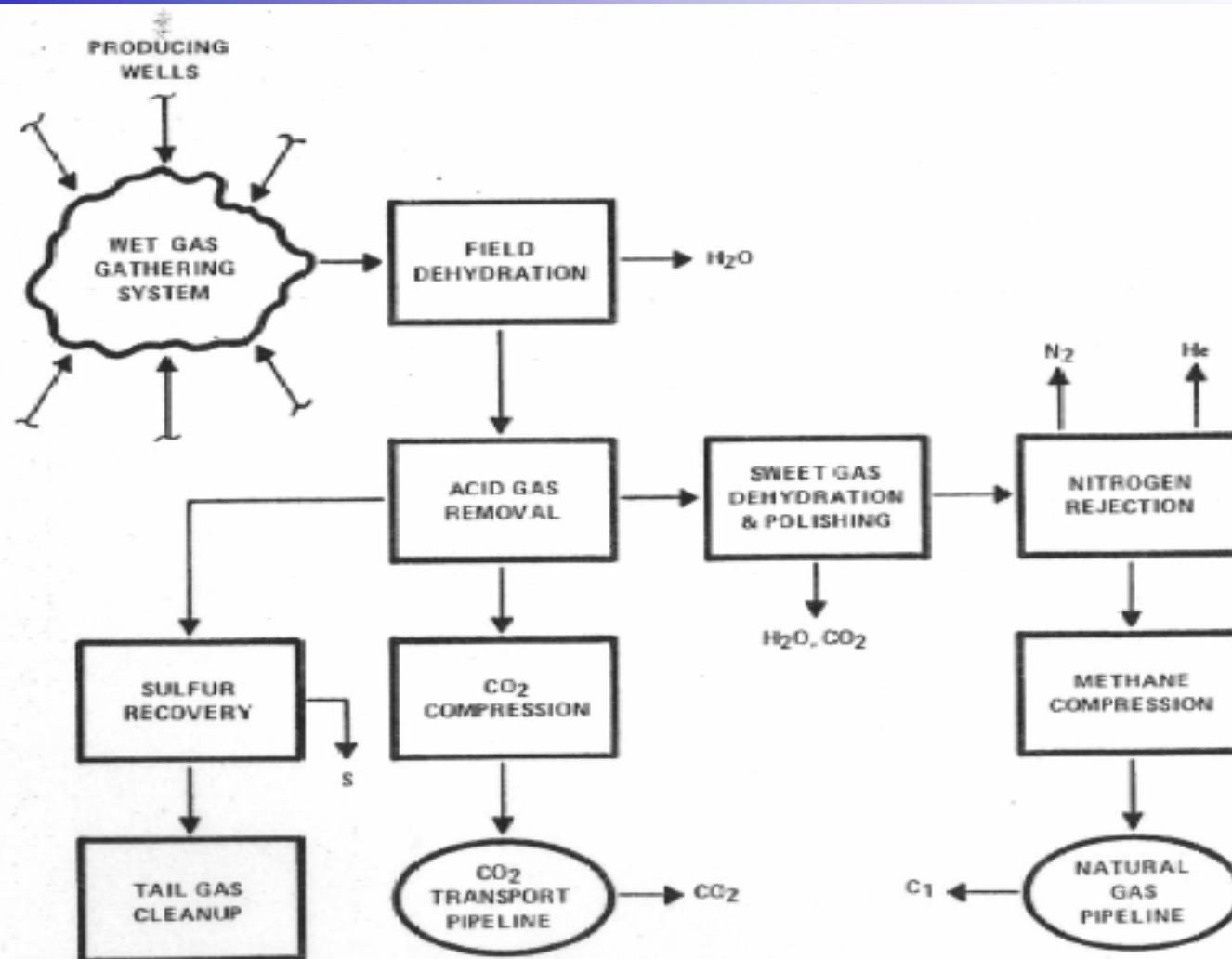

# ExxonMobil LaBarge/Shute Creek Facilities

## CO<sub>2</sub> Capture & Compression for EOR

### CO<sub>2</sub> Source and CO<sub>2</sub> Flood Locations

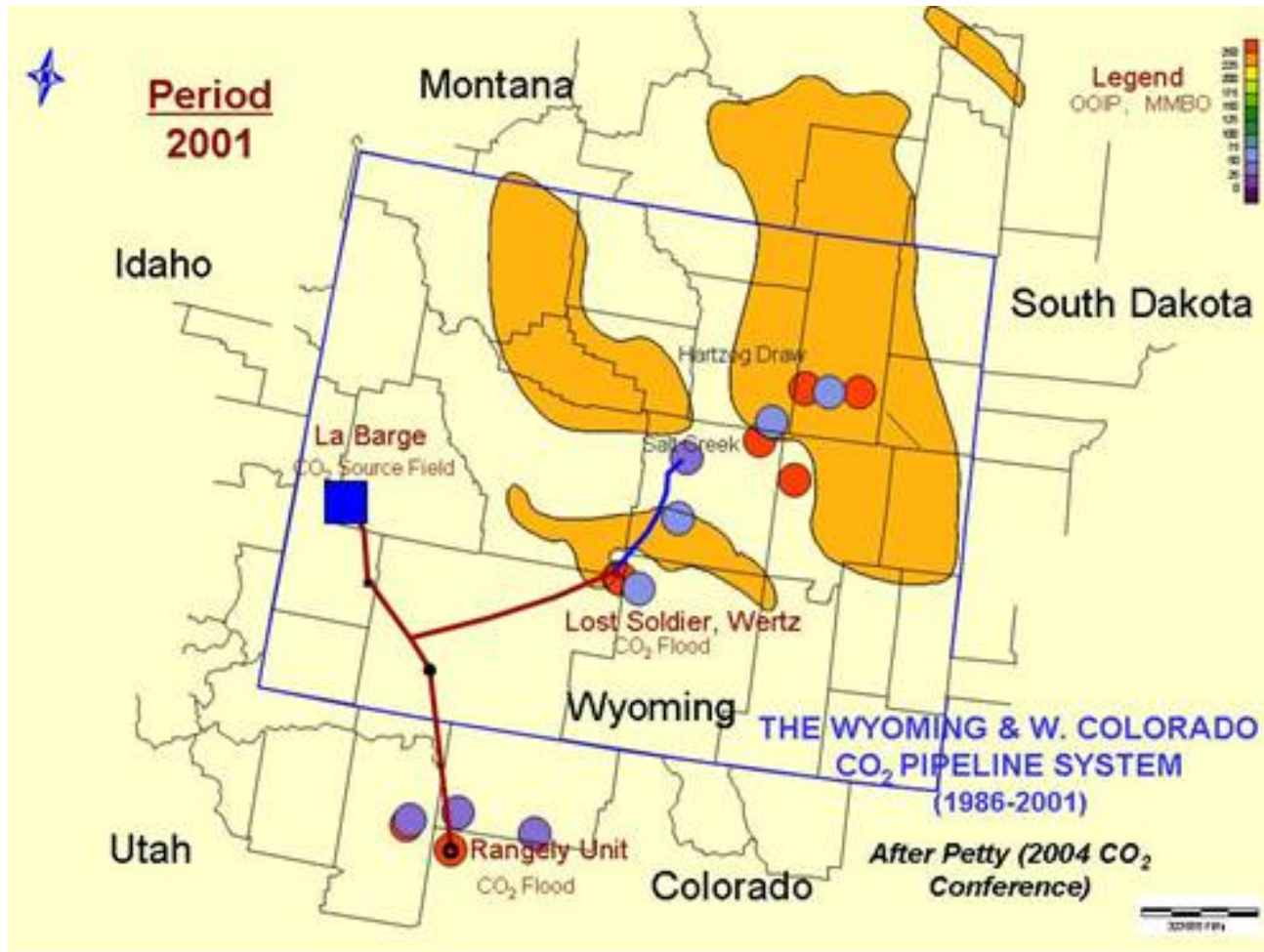

Source: Melzer Consulting / 6th Annual Conference on CC&S Conf-Pittsburgh / 10May2007



# ExxonMobil Shute Creek NG Plant Selexol Unit Process Flow Diagram H<sub>2</sub>S Removal Section

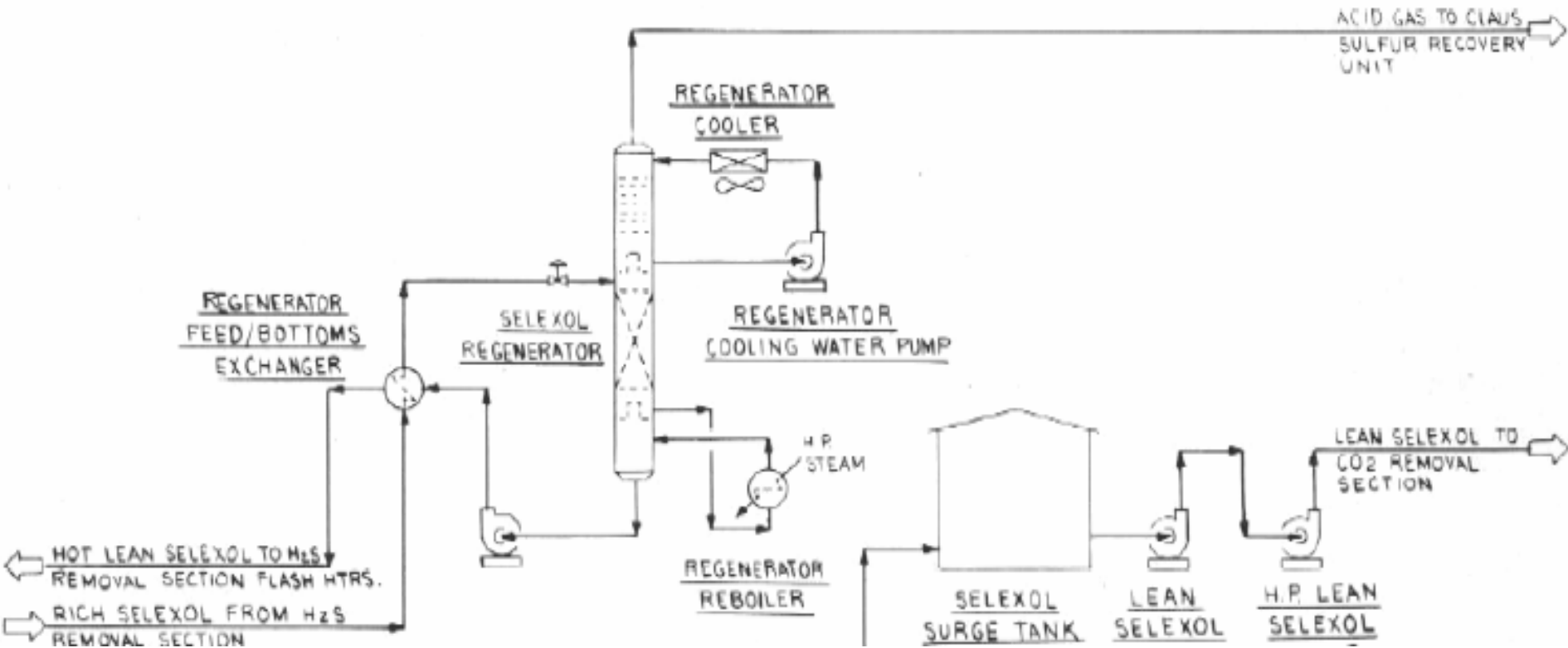

# ExxonMobil Shute Creek NG Plant Selexol Unit Process Flow Diagram CO<sub>2</sub> Removal Section

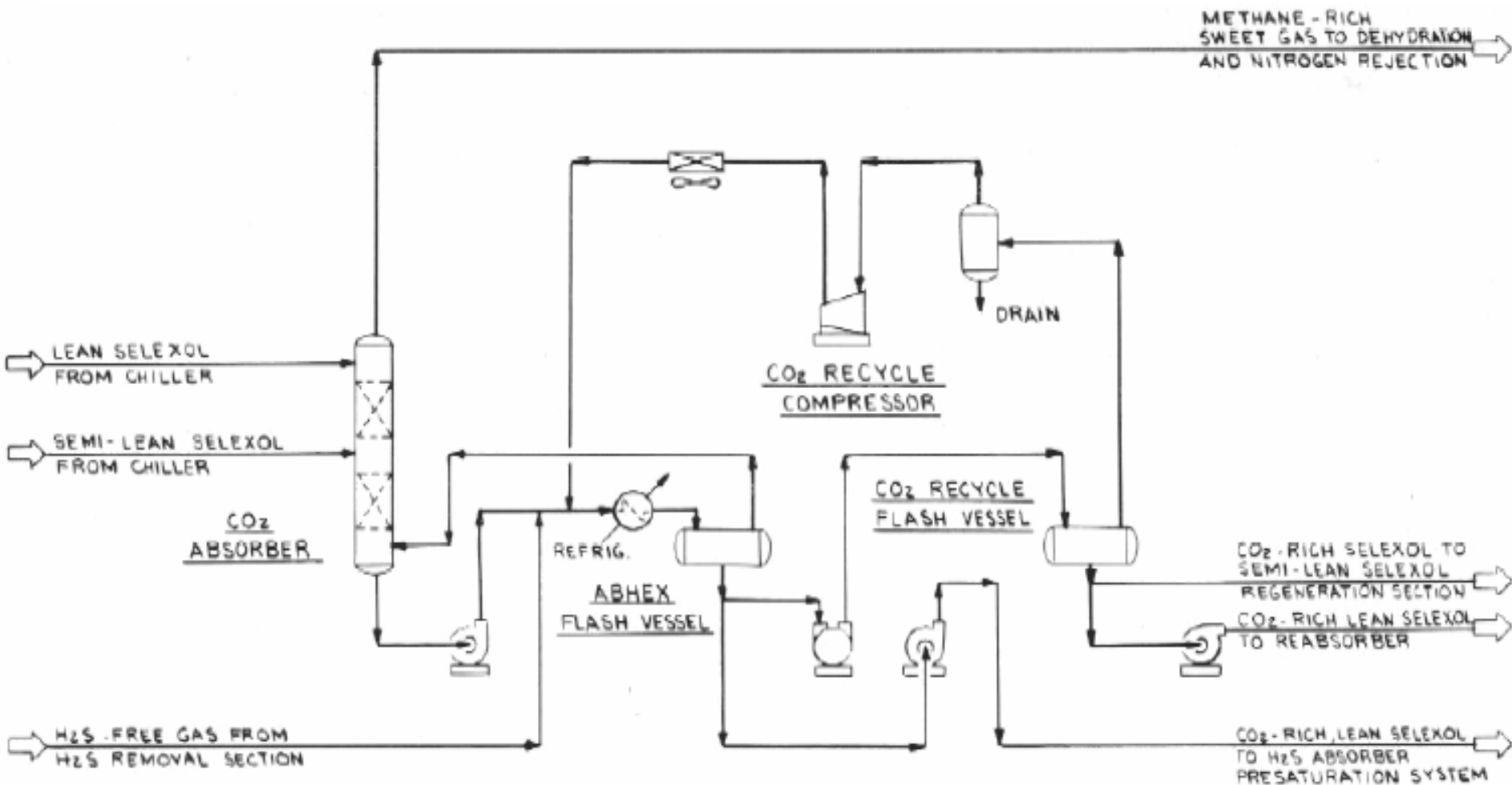

# ExxonMobil Shute Creek NG Plant Selexol Unit Process Flow Diagram CO<sub>2</sub> Regeneration Section

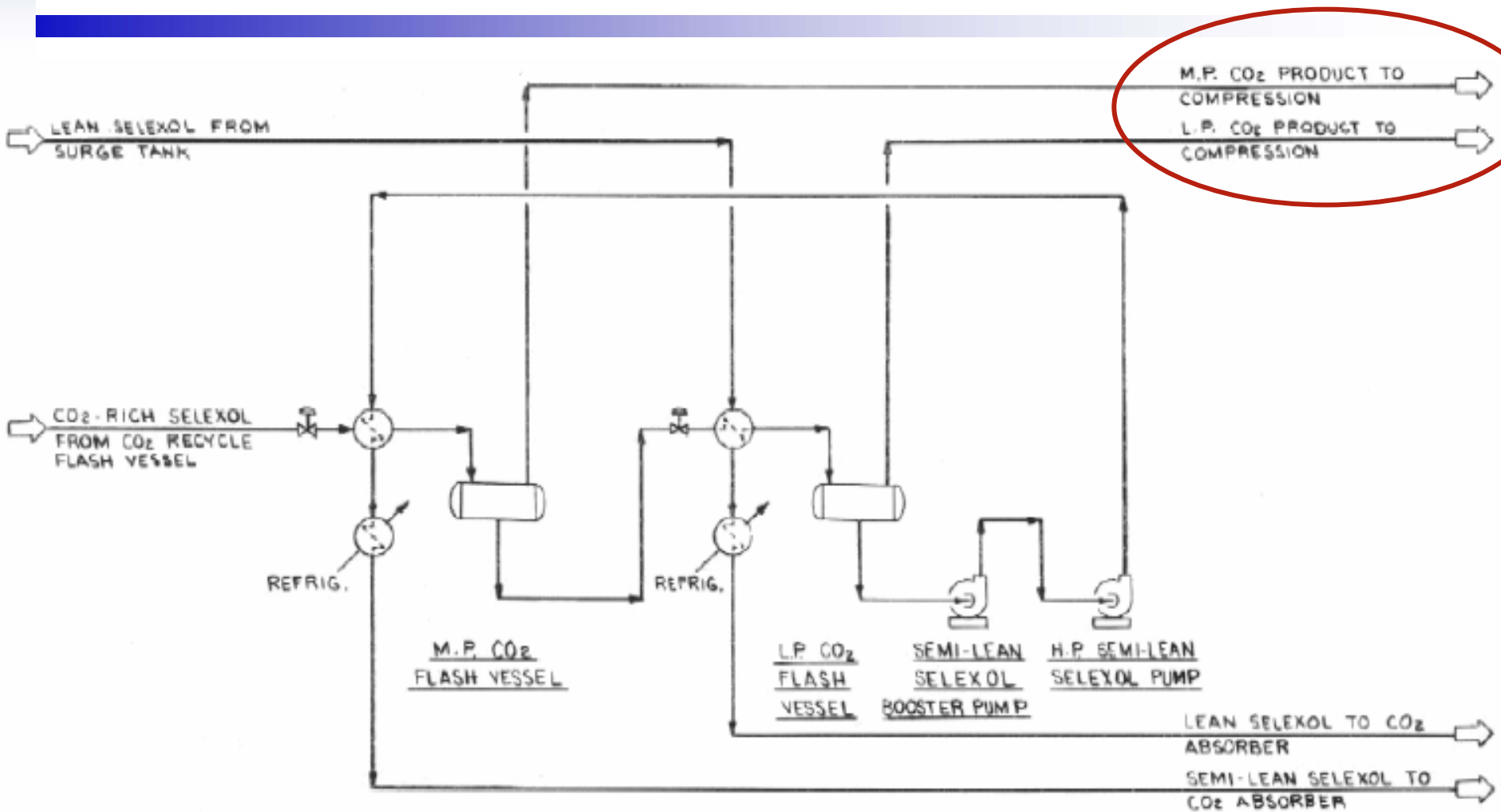

# ExxonMobil Shute Creek NG Plant

## CO2 Capture & Compression for EOR

### Existing CO2 Compression & Pipeline Steps

- **Selexol Unit Supplies CO2 at 200 & 60 (& LP?) psia**
- **270 MMSCFD (15673 STD) CO2 Compressed to 1750 psig**
  - 49,000 HP in 4 Compressor Trains
  - Supplied by Dresser-Rand
- **CO2 is transported via 2 pipelines**
  - 24-inch diameter / 48-mile long line
  - 20-inch diameter / 112-mile line

# **ExxonMobil Shute Creek NG Plant CO2 Capture & Compression for EOR Expansion of CO2 Compression & Pipeline**

- **Expansion of Facilities for Additional 110 MMSCFD (6385 STD) CO2 for Pipeline EOR**
- **Fully-funded \$72MM Project:**
  - **Detailed Design in November 2007**
  - **Long-lead Equipment Purchases Initiated in May 2008**
  - **Construction Initiated in late-2008**
  - **Commissioning Targeted by June 2010**
  - **Project Engineering Execution:**
    - **25 EXOM Engineering Staff**
    - **15 Washington Group Engineering Staff**



# ExxonMobil Shute Creek NG Plant CO2 Capture & Compression for EOR Expansion of CO2 Compression & Pipeline

- **Single 20,000-HP MP/HP compressor and a 3,000-HP LP compressor, both supplied by Dresser-Rand**
  - LP Compressor is a Dresser-Rand DATUM Model D6R4S -- radial (barrel-type) design with 4 impellers with a straight-thru casing configuration
  - MP/HP Compressor is a Dresser-rand DATUM Model D10R8B -- radial (barrel-type) design with 8 impellers with a back-to-back casing configuration
- **Will be the largest compressor unit in ExxonMobil USA Production Operations**

# ExxonMobil Shute Creek NG Plant

## CO2 Capture & Compression for EOR

### CO2 Compression – Existing & Expansion

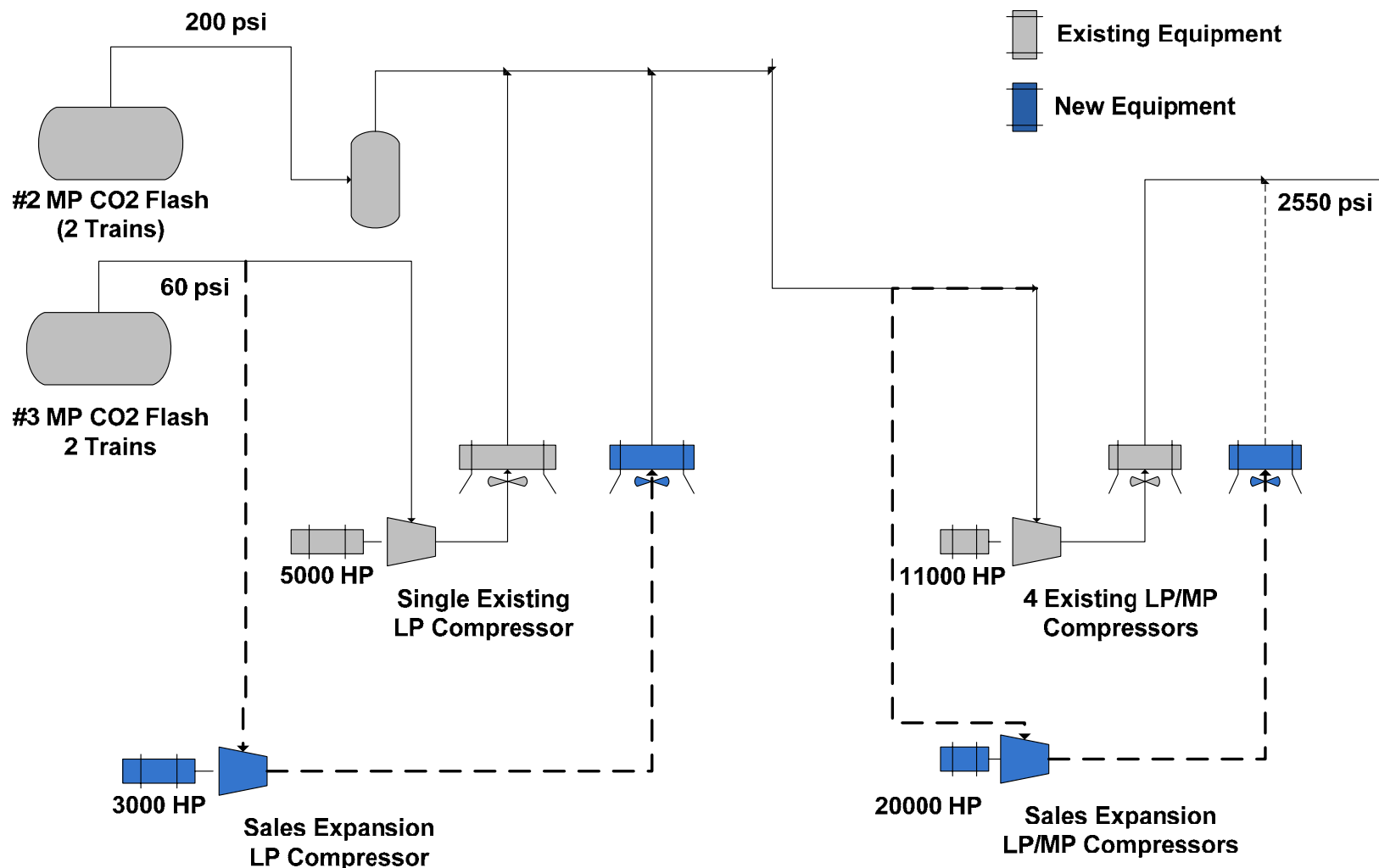

# Workshop on Future Large CO2 Compression Systems

## Large CO2 Source & Capture Systems

### Agenda

- CO2 Pipelines in USA for EOR
- 3 Large CO2 Source/Capture/Compression Plants
  - ExxonMobil LaBarge-Shute Creek, WY Natural Gas Plant
  - CDT Inc / Lubbock, TX CO2-from-CFPP-Flue Gas
  - Coffeyville Resources (KS) Gasification-based Fertilizer Plant



# Carbon Dioxide Technology Corp 1150 STD CO2 from Coal-Fired PP in Lubbock, TX Operational 1983-1984 for EOR Floods

Parallel Amine Absorbers  
190 feet elevation

Common Stripper  
CO2 Purity > 99.5%V  
CO2 Delivery ~ 5 psig

Built by Procon (UOP)

Dow Amine Technology

Gas Spec FS-1L Solvent

Lubbock Power & Light 2x50MW CFPP  
4-Stages CO2 Compression to 2000 psig



# CO2 Capture from CFPP Flue Gas

## EPRI-Nexant Report # 1014924

### Amine Process Flow Diagram

CO2 @ B.L @ 21.3 psia

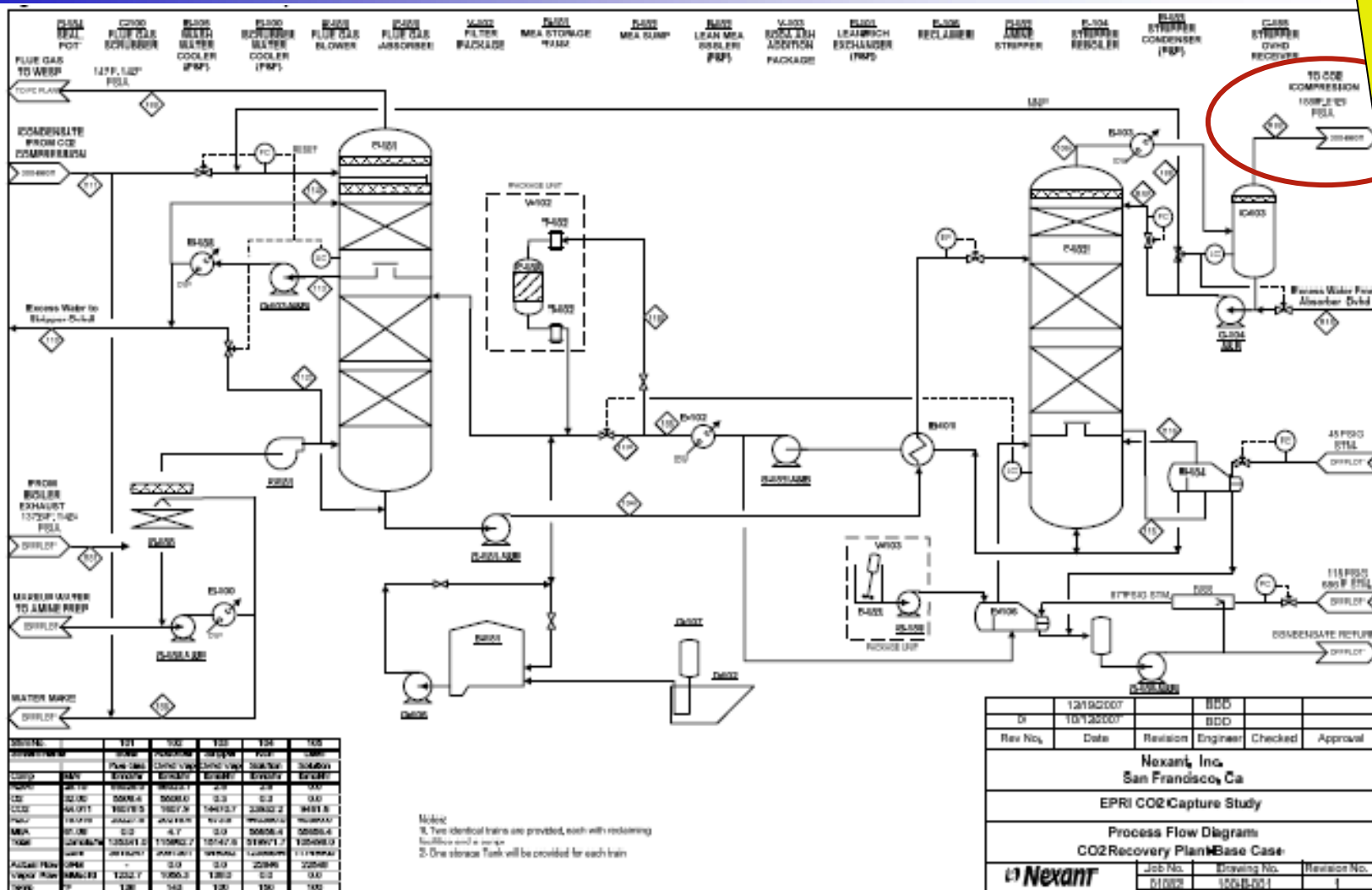

# CO2 Capture from Flue Gas

## EPRI-Nexant Report # 1014924

### CO2 Compression Process Flow Diagram

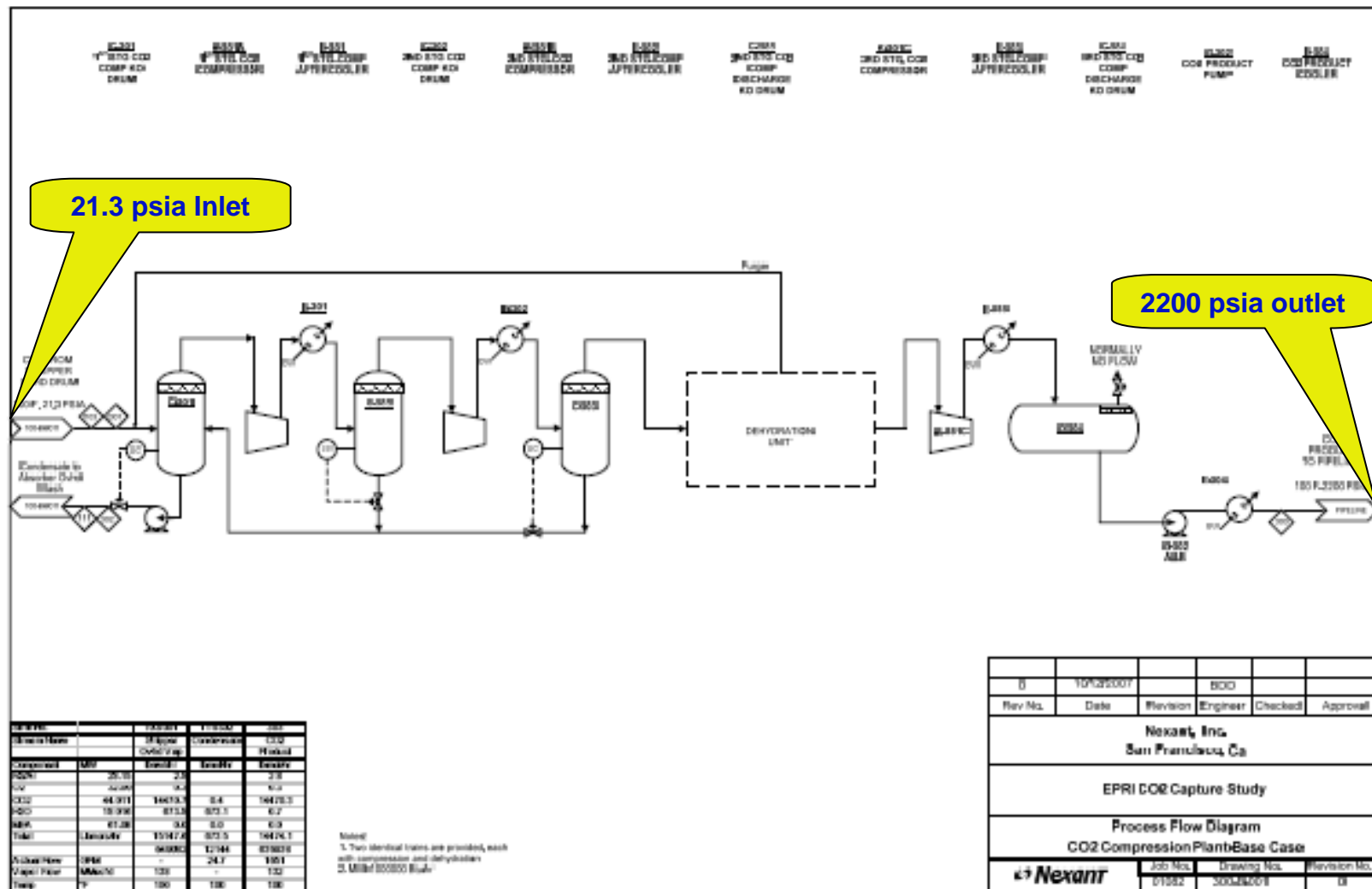

# Workshop on Future Large CO2 Compression Systems

## Large CO2 Source & Capture Systems

### Agenda

- CO2 Pipelines in USA for EOR
- 3 Large CO2 Source/Capture/Compression Plants
  - ExxonMobil LaBarge-Shute Creek, WY Natural Gas Plant
  - CDT Inc / Lubbock, TX CO2-from-CFPP-Flue Gas
  - Coffeyville Resources (KS) Gasification-based Fertilizer Plant



# Coffeyville Resources / USA

## Gasification-based NH<sub>3</sub> Plant w Full CO<sub>2</sub> Capture Key Processing Design Features

- **NH<sub>3</sub> / UAN Fertilizer Complex (Commissioned July 2000):**
  - 1140 MTD Ammonia Production
  - 1800 MTD Urea Ammonium Nitrate Solution Production
- **Coffeyville Resources Refinery Pet Coke as Feedstock (1270 MTD)**
- **GE Quench Gasifiers (2 x 100%) @ ~42 barg pressure**
- **Linde (BOC) ASU Outside Battery Limits (1450 MTD O<sub>2</sub>)**
  - High Purity N<sub>2</sub> to NH<sub>3</sub> Synthesis Loop
  - O<sub>2</sub> to Gasifier
- **2-Stage Sour CO-Shift**
- **2-Stage Selexol Unit AGRU (UOP) for separate H<sub>2</sub>S & CO<sub>2</sub> Capture**
- **10-bed PSA (UOP) for High-Purity H<sub>2</sub> to NH<sub>3</sub> Synthesis Loop**
  - 101,900 NM<sup>3</sup>/Hr of 99.3%V H<sub>2</sub> with <5 ppmv CO<sub>x</sub> & <5 ppbv Sulfur



# Coffeyville Resources / USA

## Gasification-based NH<sub>3</sub> Plant w Full CO<sub>2</sub> Capture Key Processing Design Features (cont)

- **Recycle of PSA Tail Gas to CO-Shift Unit (partial blow-down to fuel) for:**
  - Maximum H<sub>2</sub> Production
  - Maximum CO Conversion to CO<sub>2</sub>
- **EPC – Black & Veatch Pritchard**
- **Sulfur Recovery – Tessenderlo Kerley**
- **NH<sub>3</sub> / UAN – Ammonia Casale / Weatherly**
- **Well-Operated / Knowledgeable Staff / Many Lessons-Learned**
- **Profitable and Expanding Capacity**
  - USA NH<sub>3</sub> Industry Based on NG Virtually Eliminated in Past 5 Years



# Coffeyville Resources Plant Block Flow Diagram

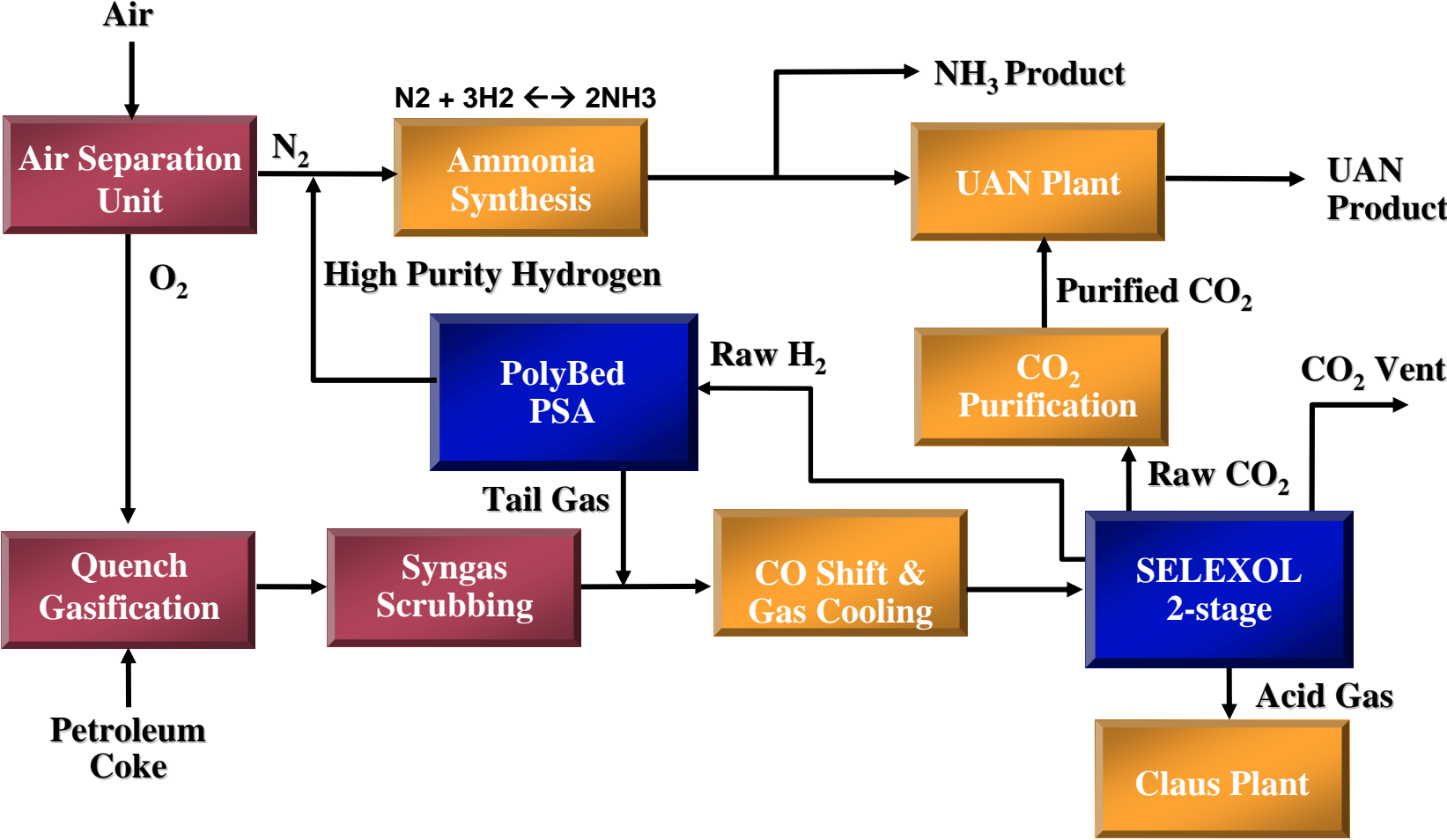

Source: UOP – GTC Conf 2002



# Coffeyville Resources

## Syngas Composition

### Post-CO-Shift & Cooling – Feed to Selexol

<b>Feed Flowrate</b>	<b>169,000 Nm<sup>3</sup>/hr</b>	<b>(151 MM SCFD)</b>
<b>Pressure</b>	<b>36.9 bar-a</b>	<b>(535 psia)</b>
<b>Temperature</b>	<b>38 °C</b>	<b>(100 °F)</b>

<b>Component</b>	<b>Mole %</b>
<b>H<sub>2</sub></b>	<b>&gt; 56</b>
<b>CO</b>	<b>~ 1.2</b>
<b>CO<sub>2</sub></b>	<b>~ 41</b>
<b>H<sub>2</sub>S and COS</b>	<b>~ 0.6</b>
<b>CH<sub>4</sub>, Ar, &amp; N<sub>2</sub></b>	<b>~ 1</b>
<b>H<sub>2</sub>O</b>	<b>Saturated</b>

2 Stages of CO-Shift

CO<sub>2</sub>/H<sub>2</sub>S Ratio ~ 70/1

Source: UOP – GTC Conf 2002



# Coffeyville Resources / USA

## Gasification-based NH<sub>3</sub> Plant w Full CO<sub>2</sub> Capture CO<sub>2</sub> Purification & Compression for UAN

- ~1/3 of the CO<sub>2</sub> (~ 780 STSD) for the CO<sub>2</sub> Compressors at ~150 psia for Urea Production
- ~2/3 of the CO<sub>2</sub> is Presently Vented at ~5 psig
- HP CO<sub>2</sub> for Urea goes through Pre-Purification Steps before Compression for Removal of Sulfur (H<sub>2</sub>S/COS) and H<sub>2</sub>/CO to Trace Levels
- CVR uses a Single Dresser-Rand Reciprocating Compressor to Compress the CO<sub>2</sub> from about ~150 to 3800 psig in three stages using 2500 HP

# Coffeyville Resources CO<sub>2</sub> (for UAN) Trim Purification PFD

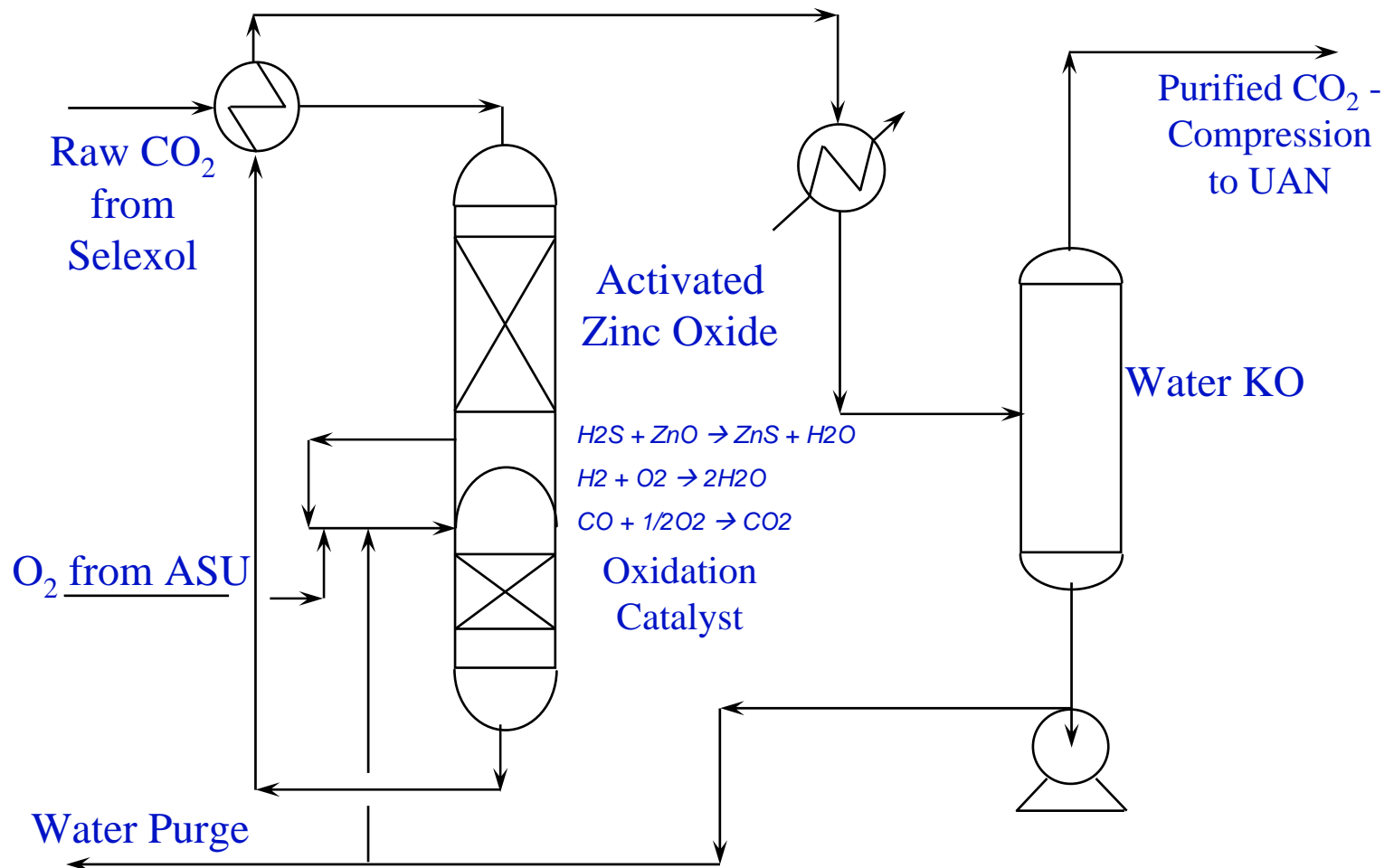

Source: BVP – LRGCC Conf 2000



# Coffeyville Resources Ammonia-UAN Fertilizer Complex – Kansas, USA CO<sub>2</sub> Purity – Pre & Post CO<sub>2</sub> Purification

Table 4  
CO<sub>2</sub> Purification Feed Composition

Component	Mole %
Hydrogen	<5%
Carbon Dioxide	95%
Hydrogen Sulfide	< 1 ppm
Methane, CO & inerts	<0.5%
Carbonyl Sulfide	10 ppm
Feed Flowrate, MMSCFD	≤11
Pressure, psia	<150
Temperature, F	28

Component	Mole %
CO <sub>2</sub>	99.32
H <sub>2</sub>	Nil
CH <sub>4</sub> & CO	Nil
H <sub>2</sub> S & COS	Nil
H <sub>2</sub> O	0.68 (Saturated @ 140 psia and 100 <sup>0</sup> F)
Pressure	~140 psia
Temperature	~100 <sup>0</sup> F

Raw CO<sub>2</sub> from Selexol Unit to Pre-Purification Unit

Source: UOP LLC (a Honeywell Company) & BV Pritchard Presentation

Laurence Reid Gas Conditioning Conference / March 2000

# Coffeyville Resources Ammonia-UAN Fertilizer Complex – Kansas, USA

## Aerial View of Plant

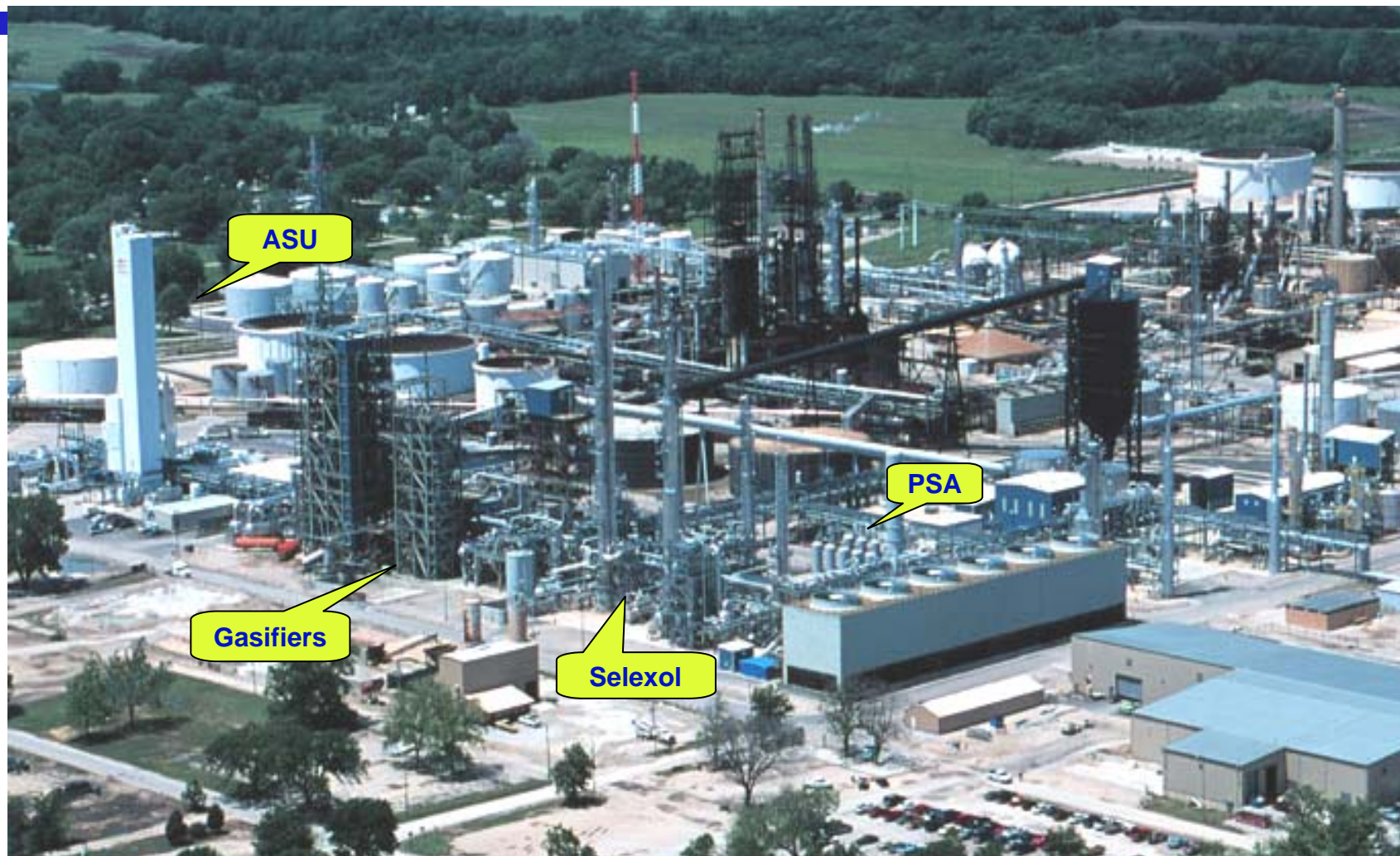

Source: UOP – GTC Conf 2002





# Coffeyville Resources (UOP) SELEXOL and PSA Units



Source: UOP – GTC Conf 2002

# **CVR Fertilizer Complex Blueprint for IGCC w CO2 Capture**



# IGCC with CO<sub>2</sub> Capture Block Flow Diagram

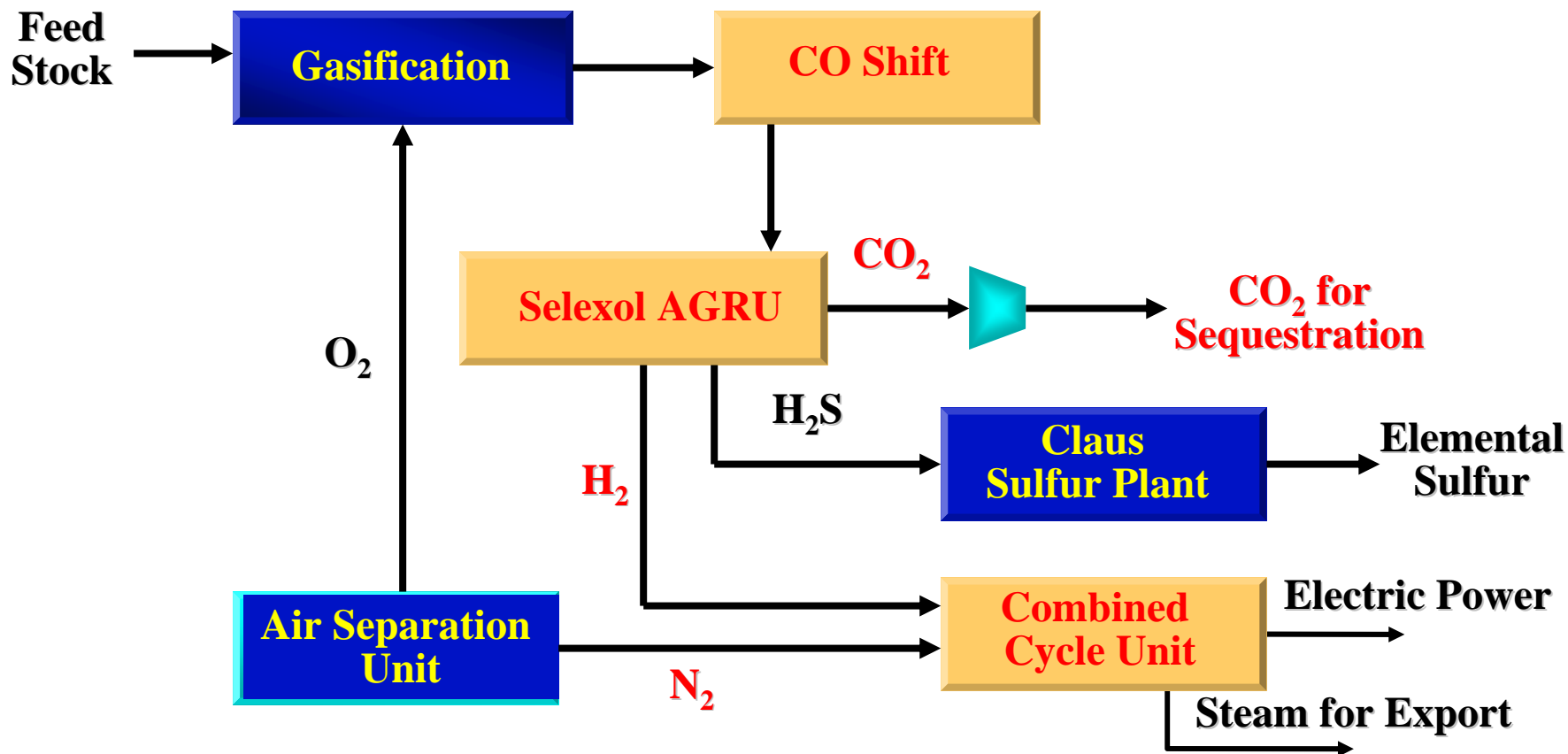

# Coffeyville Resources Plant Block Flow Diagram

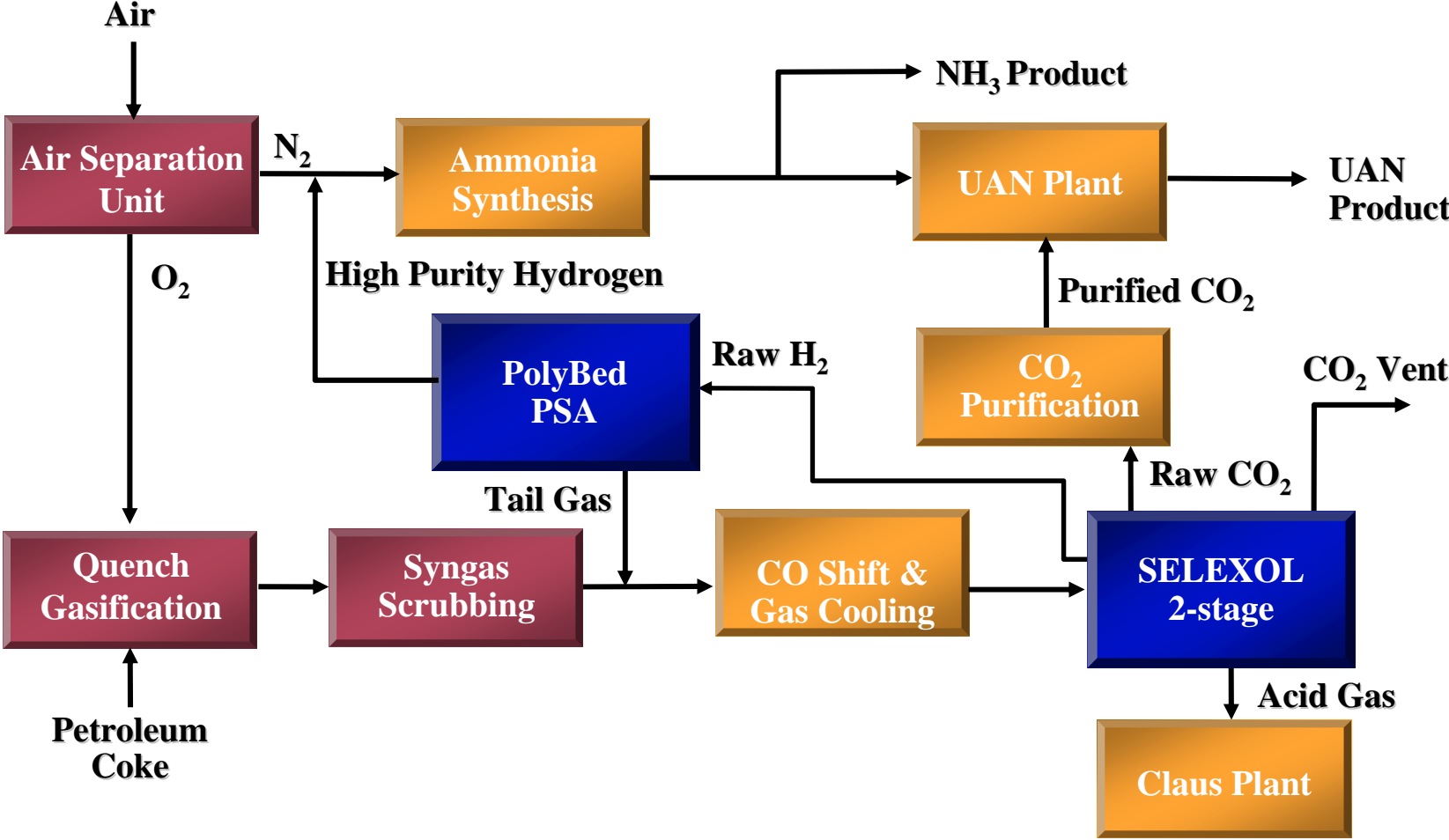

Source: UOP – GTC Conf 2002

# Coffeyville Resources Fertilizer Plant Path Forward to IGCC w CO2 Capture

- **Solid (Pet Coke) Feedstock**
- **Quench Gasifier for CO-Shift-Ready Syngas**
- **2-Stage Sour CO-Shift for High CO Conversion**
- **2-Stage Selexol for Separate H2S and CO2 Capture**
  - **CO2 Capture > 90%**
  - **Portion of CO2 Delivered at Elevated Pressure for Compression**
  - **Portion of CO2 “Sequestered” via N2-Fixation (Fertilizer)**
- **Combination of H2 and N2 for NH3 Synthesis**
  - **(For IGCC – combination to Gas Turbine)**
- **CO2 Trim Purification (dependent upon specifications)**
- **Production of High-Purity H2 by PSA**
  - **(Potential for Fuel Cell Usage)**

# Coffeyville Resources Fertilizer Plant – foreground

## Coffeyville Resources Refinery – background

### Thank You & Questions!



Source: UOP – GTC Conf 2007

## Session 2.4

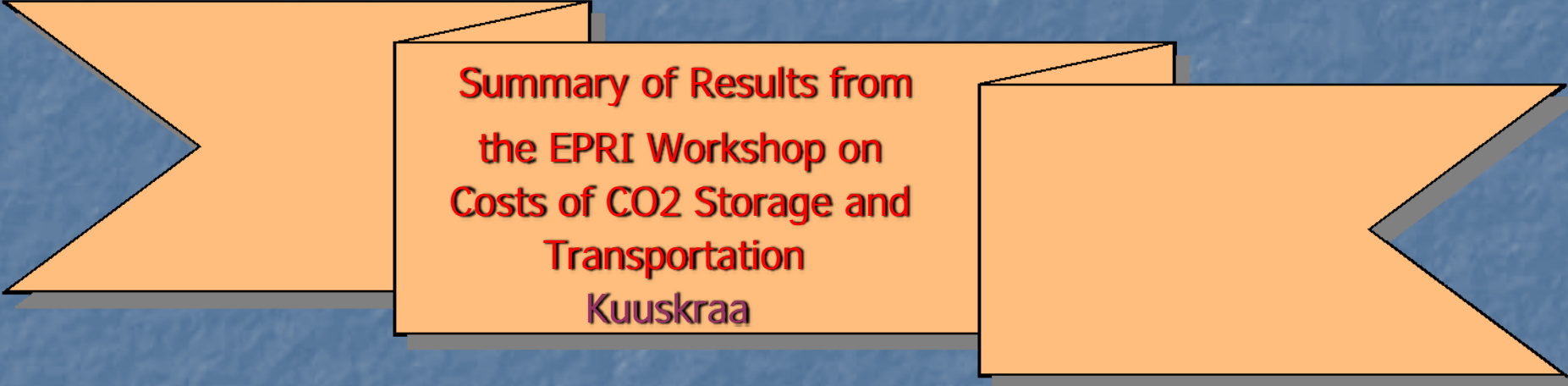

**Summary of Results from  
the EPRI Workshop on  
Costs of CO<sub>2</sub> Storage and  
Transportation**  
Kuuskraa

# Summary of Results from the EPRI Workshop on Costs of CO2 Transport and Storage

---

Prepared for:  
**Workshop on Future Large CO2 Compression Systems**

Sponsored by:  
**U.S. DOE Office of Clean Energy Systems, EPRI, and NIST**

Prepared by:  
**Vello A. Kuuskraa**  
**President, Advanced Resources International**  
**Arlington, VA USA**

**March 30, 2009**





# Outline of Presentation

---

- Background
- EPRI Workshop Session #2: Cost of Compression and Transport
- Lessons Learned from the Gas Storage Industry

# Background

---

The Electric Power Research Institute (EPRI), with organizational assistance from Advanced Resources International, Inc. (ARI), sponsored the recent “Workshop on Costs of CO2 Transport and Storage”. The Workshop was held in Palo Alto, California on March 17th and 18th, 2009.

The purpose of the Workshop was to gain up-to-date perspectives on: (1) recent experiences and cost information for transporting CO2 from a power plant gate to a geological storage site; (2) updates on the costs of installing and operating a CO2 storage facility; (3) updates on the costs of implementing a comprehensive CO2 storage monitoring system; and, (4) the need for and costs of a reliable remediation plan for addressing CO2 injection well or other problems associated with CO2 storage.

# Background

---

The workshop was organized according to six topics, as follows:

- Session #1: Integrated Capture, Transport and Storage Modeling
- Session #2: Cost of Compression and Transportation
- Session #3: Cost of CO2 Storage Site Selection, Appraisal and Modeling
- Session #4: Cost of Designing, Constructing and Operating CO2 Storage
- Session #5: Cost of CO2 Storage Monitoring
- Session #6: Cost of CO2 Storage Remediation and Mitigation

The highlights from the various presentations and the subsequent extensive participant discussion during the Workshop have been documented in a Summary Report for EPRI.

## **Session #2: Cost of Compression and Transportation** **Tuesday, March 17, 2009, 10:30AM – 12:00 Noon**

The purpose of this second workshop session was to discuss and set forth methodology for calculating the capital and operating costs of CO<sub>2</sub> transportation systems, including taking a look at advances in CO<sub>2</sub> compression technology that may influence future costs.

Of particular interest was the discussion on: (1) the economies of scale for CO<sub>2</sub> transportation; (2) how incorporation of special features (e.g., river crossings) affects costs; and, (3) how to make optimum trade offs between size of pipe and booster compression.

Two presentations were provided on these important topics during Session #2, followed by Open Discussion:

- Costs of CO<sub>2</sub> Transportation Systems (Kinder Morgan), K. Havens (45 min)
- Advanced CO<sub>2</sub> Compression Systems (RAMGEN), P. Baldwin (15 min)
- Open Discussion w/K. Havens as Discussion Leader (25 min)

# EPRI Workshop

March 17, 2009

## Costs of CO<sub>2</sub> Transmission Systems

Ken Havens

Director of Source and Transportation



# Domestic CO<sub>2</sub> Industry Operational Achievements

Over the past 30+ years, the oil and gas industry has:

- Produced and safely transported more than 11 TCF of CO<sub>2</sub> from 7 sources.
  - 1.2 TCF of which came from sources that otherwise would have been vented.
- Constructed over 3100 miles of CO<sub>2</sub> mainline pipeline systems.
- Produced in excess of 1.2 billion barrels of incremental oil.
- Secured operating practices of:
  - Corrosion management, Metallurgies, Elastomers
  - Separation, Dehydration and Hydrocarbon extraction
  - Compression/pumping
  - Injection and production well completion and operation

# KMCO<sub>2</sub> FACILITIES

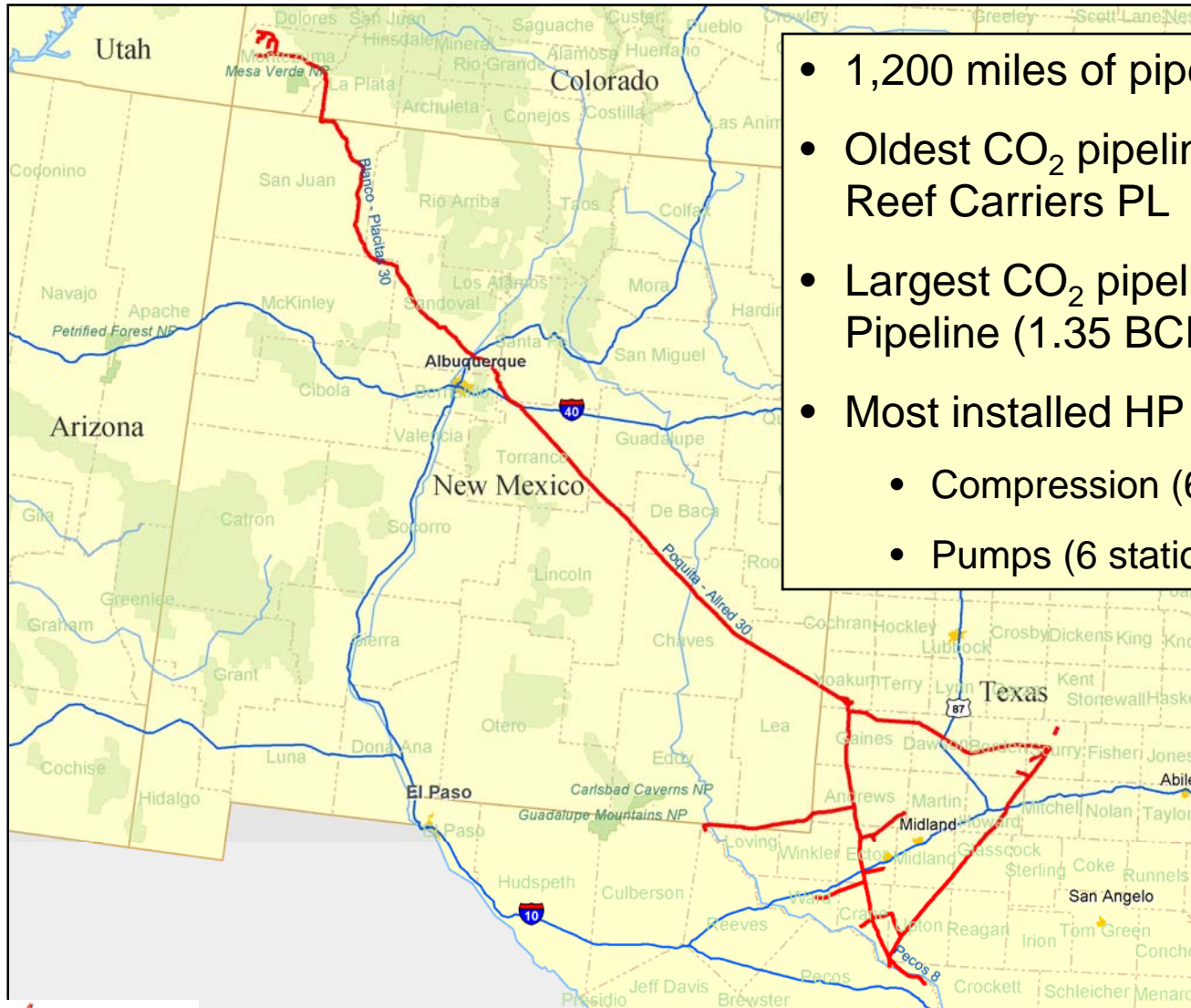

- 1,200 miles of pipeline
- Oldest CO<sub>2</sub> pipeline (1974), Canyon Reef Carriers PL
- Largest CO<sub>2</sub> pipeline 30" OD Cortez Pipeline (1.35 BCFD)
- Most installed HP
  - Compression (6 stations)      70,000
  - Pumps (6 stations)              40,000

# CO<sub>2</sub> vs Gas Pipelines

- Use same steel metallurgy as Natural Gas Pipelines
  - Keep CO<sub>2</sub> dry
- Higher operating pressures
  - Gas – 600 psig to 1200 psig
  - CO<sub>2</sub> – 2000 to 3000 psig
  - Why? Maintain CO<sub>2</sub> in dense phase (>1300 psig) to allow pumping rather than compression.
- Pumps rather than compression
  - Energy savings
- CO<sub>2</sub> - PHMSA regulated under CFR Part 195, “Transportation of Hazardous Liquids by Pipeline”





# Environmental Health and Safety

- CO2 pipelines are protected from damage by
  - 24 hour monitoring by Control Center
  - Membership in statewide one-call
  - Compliance with Common Ground Alliance Best Practices
  - Patrolled by air 26 times per year
- CO2 pipelines are protected from corrosion by:
  - Annual pipe to soil survey of pipeline
  - Five year cycle of Close Interval Surveys
  - Assessments of High Consequence Areas under Pipeline Integrity Management program

# Pipeline Integrity Management

- Assess, evaluate, repair and validate the integrity of the pipeline systems to meet or exceed the requirements of CFR Part 195.452, Pipeline Integrity Management
- Worked with PHMSA to utilize External Corrosion Direct Assessment to assess High Consequence areas
- Worked with high-resolution Magnetic Flux Tool manufacturers to develop pig to run in CO<sub>2</sub>
- Completed high-resolution Magnetic Flux Tool run in November 2007 on the oldest CO<sub>2</sub> PL



# CRC Pipeline Hydrotest

- 36 days out of service
- Tested 131 miles of 16" pipeline
- Raised MOP 1792 to 2025



# CO<sub>2</sub> Pipeline Specifications

Following are specifications for CO<sub>2</sub> pipeline quality CO<sub>2</sub>.

9.1 Specifications. The Product delivered by Seller or Seller's representative to Buyer at the Delivery Point shall meet the following specifications, which herein are collectively called "Quality Specifications":

- (a) **Product**. Substance containing at least ninety-five mole percent (95%) of Carbon Dioxide.
- (b) **Water**. Product shall contain no free water, and shall not contain more than thirty (30) pounds of water per mmcf in the vapor phase.
- (c) **Hydrogen Sulfide**. Product shall not contain more than twenty (20) parts per million, by weight, of hydrogen sulfide.
- (d) **Total Sulfur**. Product shall not contain more than thirty-five (35) parts per million, by weight, of total sulfur.
- (e) **Temperature**. Product shall not exceed a temperature of one hundred twenty degrees Fahrenheit. (120°F).
- (f) **Nitrogen**. Product shall not contain more than four mole percent (4%) of nitrogen.
- (g) **Hydrocarbons**. Product shall not contain more than five mole percent (5%) of hydrocarbons and the dew point of Product (with respect to such hydrocarbons) shall not exceed minus twenty degrees Fahrenheit (-20oF).
- (h) **Oxygen**. Product shall not contain more than ten (10) parts per million, by weight, of oxygen.
- (i) **Other**. Product shall not contain more than 0.3 (three tenths) gallons of glycol per MMcf and at no time shall such glycol be present in a liquid state at the pressure and temperature conditions of the pipeline.



# Pipeline Costs

100 miles of 24" pipe line (500 MMCFD)

- Flat Dry Land \$120,000,000
- Mountains \$204,000,000
- High Populated Urban \$250,000,000
- Offshore 150 – 200 ft. \$1,680,000,000

Compression - 5,000 HP Electric Drive \$10,000,000

Pumps - 4,000 HP Electric Drive \$8,000,000

Measurement Station (500 MMCFD) \$500,000



# Lessons Learned from the Gas Storage Industry

---

Prepared for:

**EPRI Workshop on Costs of CO2 Transport and Storage**

Prepared by:

**Vello A. Kuuskraa**

**President, Advanced Resources International**

**Arlington, VA USA**

**Palo Alto, CA**

**Stanford Park Hotel**

**March 17-18, 2009**



## ***What Lessons Have We Learned From the Gas Storage Industry?***

---

The oldest U.S. gas storage site is the Zoar field, a depleted gas reservoir located south of Buffalo, NY. It has been in operation since 1916 and is still in use today.

The U.S. has 400 active underground gas storage facilities, with 43 of these aquifers, holding 8.4 trillion cubic feet (140 million metric tons of CH<sub>4</sub>, equal to 380 million metric tons of CO<sub>2</sub>). Annually, 3 to 4 Tcf of natural gas are injected and withdrawn, equal to 160 million metric tons of CO<sub>2</sub>.

Worldwide there are 634 underground gas storage facilities:

- 83.5% in depleted oil/gas fields
- 12.6% aquifers
- 3.9% salt caves/abandoned mines



## ***What Lessons Have We Learned From the Gas Storage Industry?***

---

- Lesson #1. The Operation of Underground Natural Gas Storage Has Been Extremely Safe.
- Lesson #2. Improperly Selected Storage Sites With Caprock Problems Have Led to Gas Leakage.
- Lesson #3. Extensive Use of Monitoring Wells Is Used to Detect Loss of Gas from the Storage Structure.
- Lesson #4. Improper Well Plugging, Defective Casing and Poor Cement Placement Can Lead to Gas Leakage.
- Lesson #5. It May Be Possible to Improve the Injectivity of Lower Permeability Storage Sites With “New and Novel” Well Stimulation Technologies.



## Session 2.5

The image features three overlapping orange banners with black outlines and a slight drop shadow. The banners are arranged horizontally, with the middle one being the largest and containing the text. The left and right banners are smaller and have a pointed end. The background is a textured blue.

**Maddocks**



# Workshop on Future Large CO<sub>2</sub> Compression Systems



## Gas Processing – GLE

- ✦ Over 120 gas processing projects completed in the last 20 years.
- ✦ Capacity from 5 MMSCFD to > 2 BSCFD
- ✦ Multiple projects with refrigeration and liquids recovery
- ✦ Multiple sour gas projects with amine plants and sulphur facilities or acid gas injection.
- ✦ Typically 1-2 cryogenic plants with turbo expanders each year.
- ✦ Typically 2-4 acid gas injection projects each year.



## Acid Gas Injection - GLE

### Acid Gas Injection Projects

- Originally consisted of small scale  $H_2S/CO_2$  injection projects designed to minimize  $SO_2$  emissions, ease resident concerns and speed regulatory approval.
- Small scale sulphur plants were considered capex/opex intensive and still resulted in emissions.

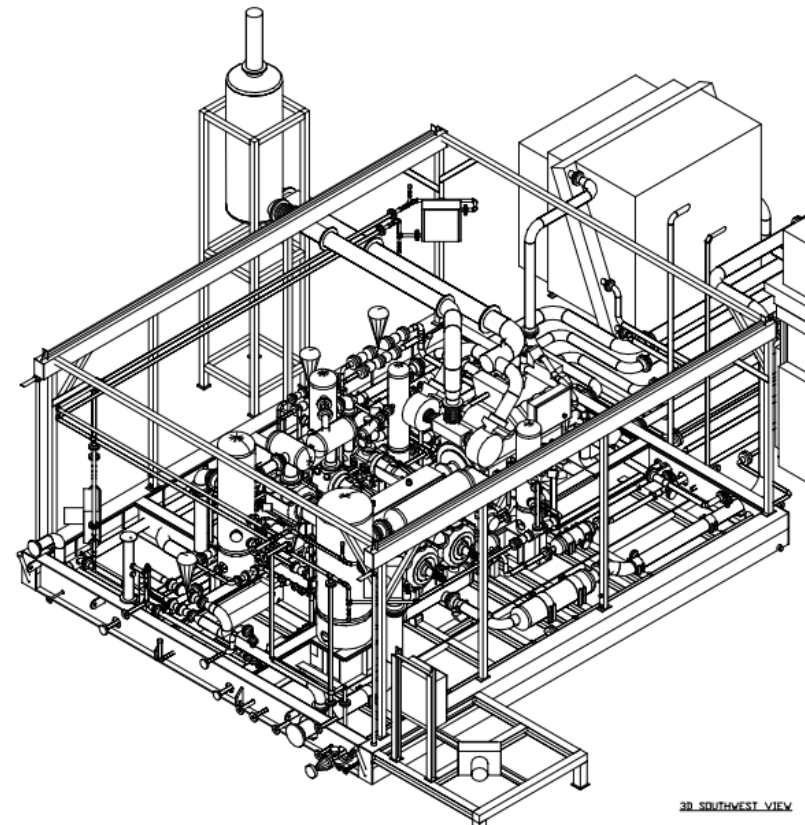

## Acid Gas Injection Projects

- Over 50 acid gas injection (for disposal) projects in North America
- Primarily for H<sub>2</sub>S disposal but all streams contain CO<sub>2</sub>. A few projects are primarily CO<sub>2</sub> injection.
- Injection rates range from <1 MMSCFD to 18 MMSCFD in Canada
- ExxonMobil at LaBarge injects about 90 MMSCFD
- Process components after amine plant are either compression with integrated partial dehydration or compression and standard dehydration
- Various conceptual projects are in the design stages in the Middle East for acid gas injection rates to exceed 400 MMSCFD.

## Acid Gas Compression

- Typical existing installations are reciprocating compressors.
- Larger volume conceptual projects in Middle East are being designed with centrifugal compressors.
- Injection pressures can range from 500 psi to over 3000 psi depending upon the depth and permeability of the formation.
- Formations are typically depleted reservoirs or deep aquifers.
- These “relatively” small projects can be designed and operated safely with existing technology.



## CCS – an engineering perspective

- Within the natural gas industry the challenge is to scale up the facilities including injection schemes to handle larger volumes  $>300$  MMSCFD.
- Within the power industry the challenge is to adapt/improve on the existing technology for larger scale CCS.



## CCS – an engineering perspective

- A simple **natural gas** combined cycle power plant making 750 MW can produce  $2.59 \times 10^6$  ton/yr of  $\text{CO}_2$ .
- After  $\text{CO}_2$  recovery at 90% we would need to inject about 110 MMSCFD of nearly pure  $\text{CO}_2$ .
- Although dependent upon location and formation it can be estimated that around 34-40,000 BHP of compression will be required. This can be reduced with sub-critical subcooling and liquid  $\text{CO}_2$  pumping.
- Each CCS project will require extensive multiple stages of compression power, dehydration, water handling, and controls.
- Wet  $\text{CO}_2$  is very corrosive – interstage wet piping, coolers and vessels will require extensive use of stainless steel.





## CCS – an engineering perspective

- Major engineering challenges include:
  - Considerable capital expense, equipment and utility requirements.
  - Integration within an existing facility.
    - Space and footprint issues.
    - Parasitic power demands of 25-35% (varying estimates)
  - Equipment challenges including sealing, turndown, maintenance, redundancy, efficiency.
  - Phase behaviour and confidence in EOS predictions.
  - Moisture content, water control and water disposal.
  - Materials and corrosion engineering
  - Access to sequestration zones and/or pipelines
  - Regulatory Issues
    - Residents and public management
    - Pipeline integrity and management
    - Wellbore and sequestration integrity – can we guarantee sequestration and not migration?





# GAS LIQUIDS ENGINEERING



# Session 2.6

Three overlapping orange banners are arranged horizontally. The leftmost banner has a pointed right end. The middle banner is the largest and contains the text 'Amick'. The rightmost banner has a pointed left end. All banners have a black outline and a slight drop shadow.

**Amick**

# Workshop on Future Large CO2 Compression Systems

Gaithersburg, Maryland  
March 30, 2009

## *Gasification Project Outlook*

Phil Amick  
Commercialization Director, Gasification  
[Phil.Amick@ConocoPhillips.com](mailto:Phil.Amick@ConocoPhillips.com)

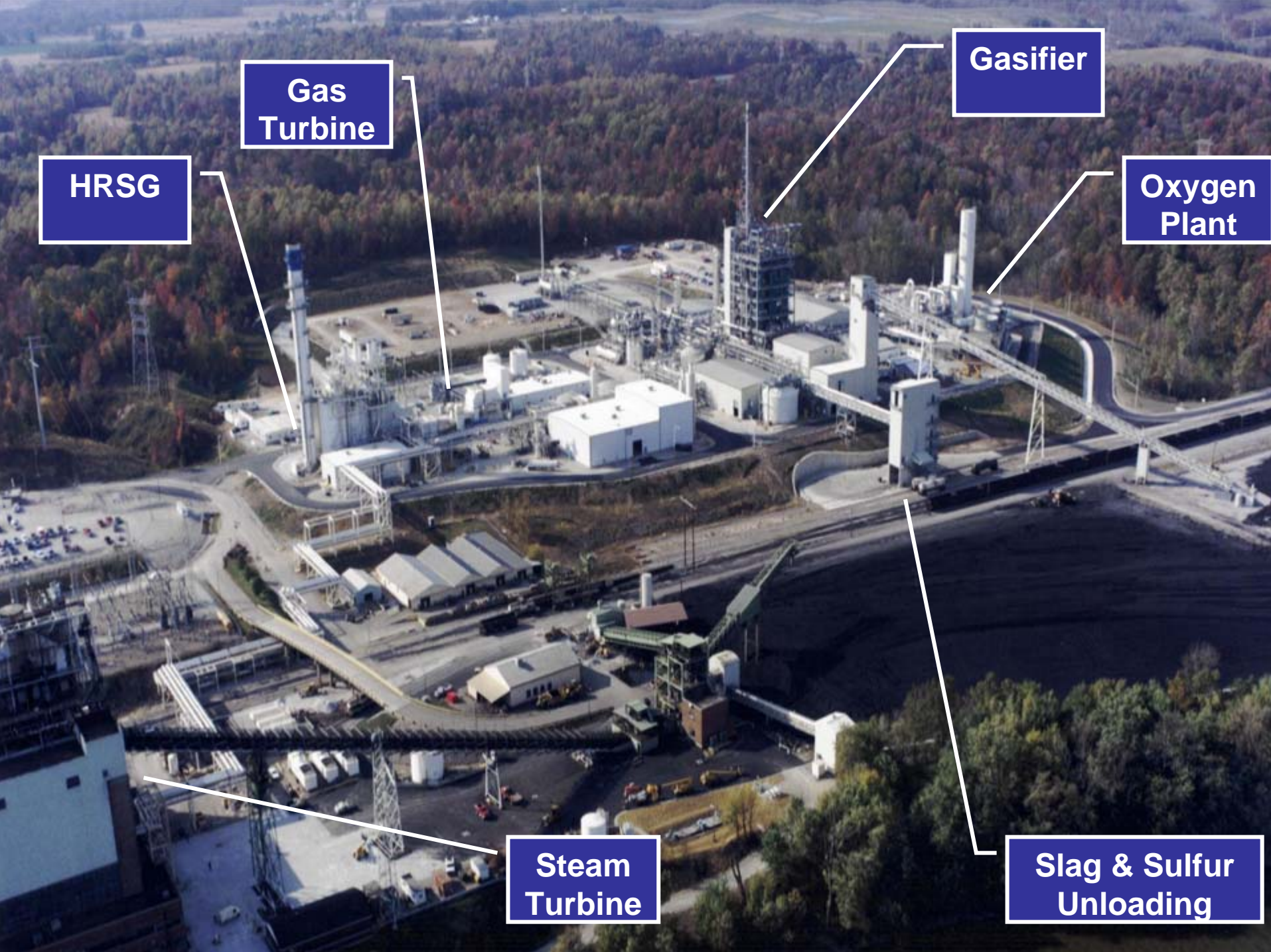

**HRSG**

**Gas  
Turbine**

**Gasifier**

**Oxygen  
Plant**

**Steam  
Turbine**

**Slag & Sulfur  
Unloading**

# Kentucky NewGas Project

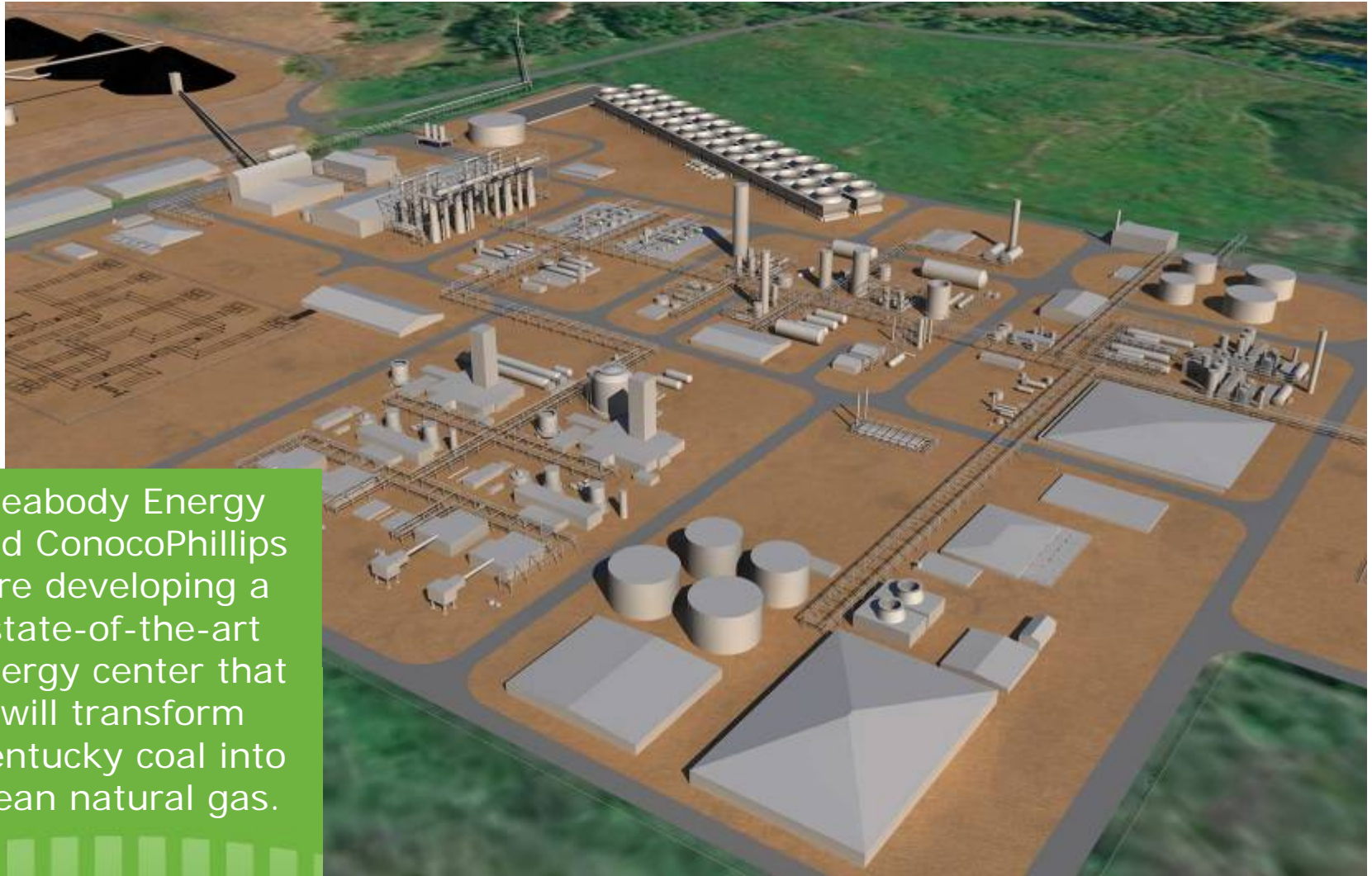

Peabody Energy and ConocoPhillips are developing a state-of-the-art energy center that will transform Kentucky coal into clean natural gas.

# SNG Process Scrubs Carbon from Coal

- Honest “storage ready” CO<sub>2</sub> and Substitute Natural Gas
- Scrubs carbon from the coal and petcoke as CO<sub>2</sub>
- More than 90% of CO<sub>2</sub> generated in the process is captured
- Sequestration places coal on a similar CO<sub>2</sub> footing as natural gas

## Carbon Balance

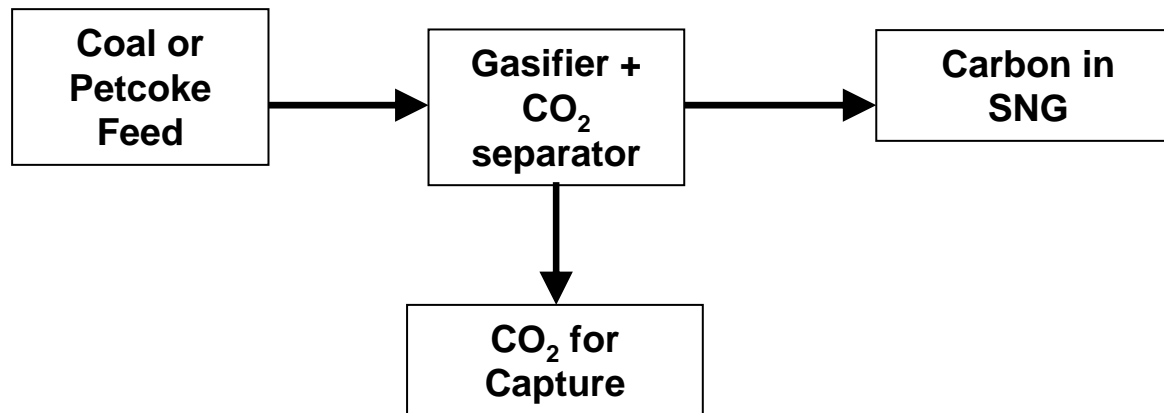

**Greater than 90% CO<sub>2</sub> Capture**

# Carbon Capture & Compression Costs

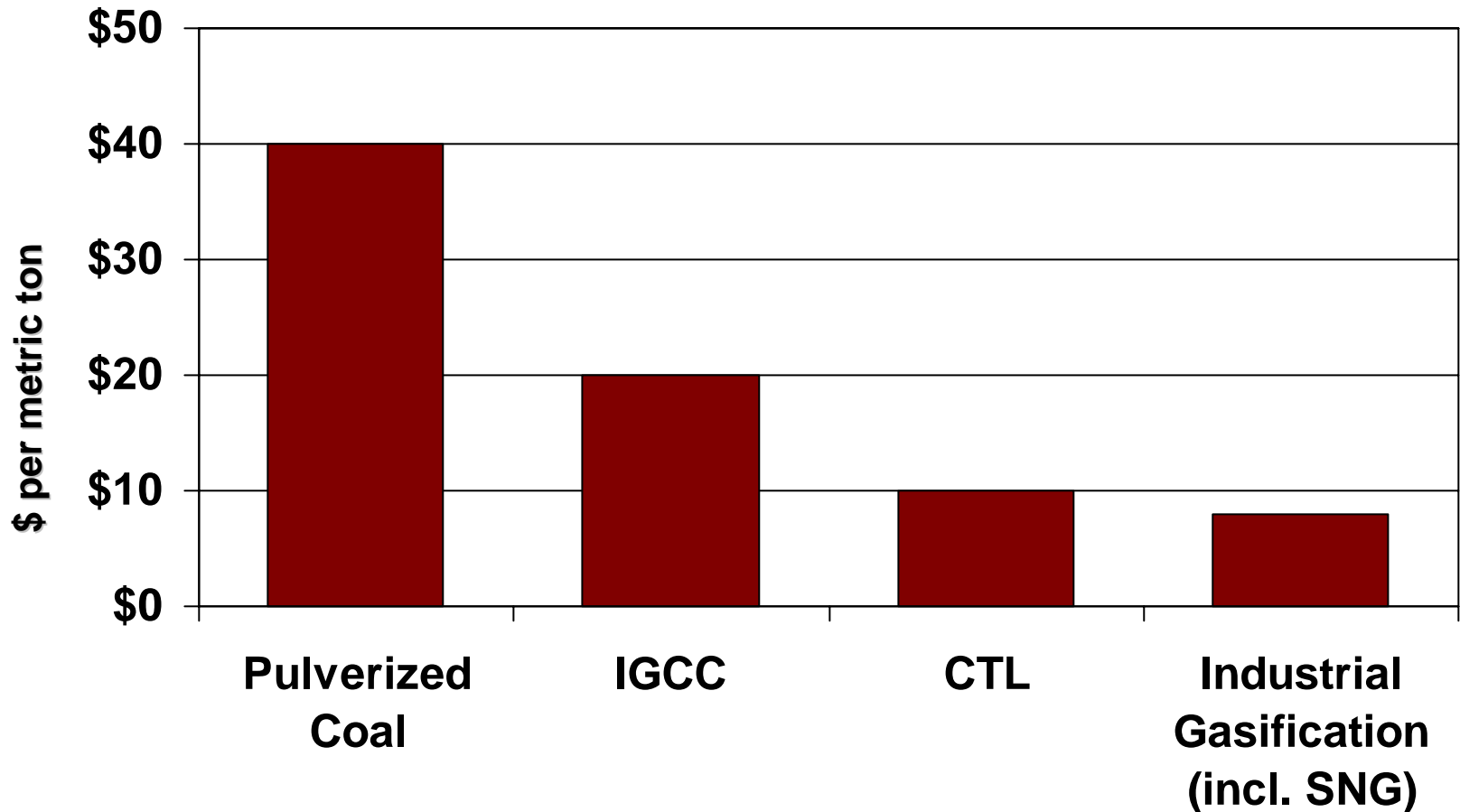

Reference: Jim Childress, Gasification Technology Council,  
Electric Power 2008 <http://www.gasification.org>

Sources: MIT, Eastman Chemical



# CO<sub>2</sub> Emissions from Electricity

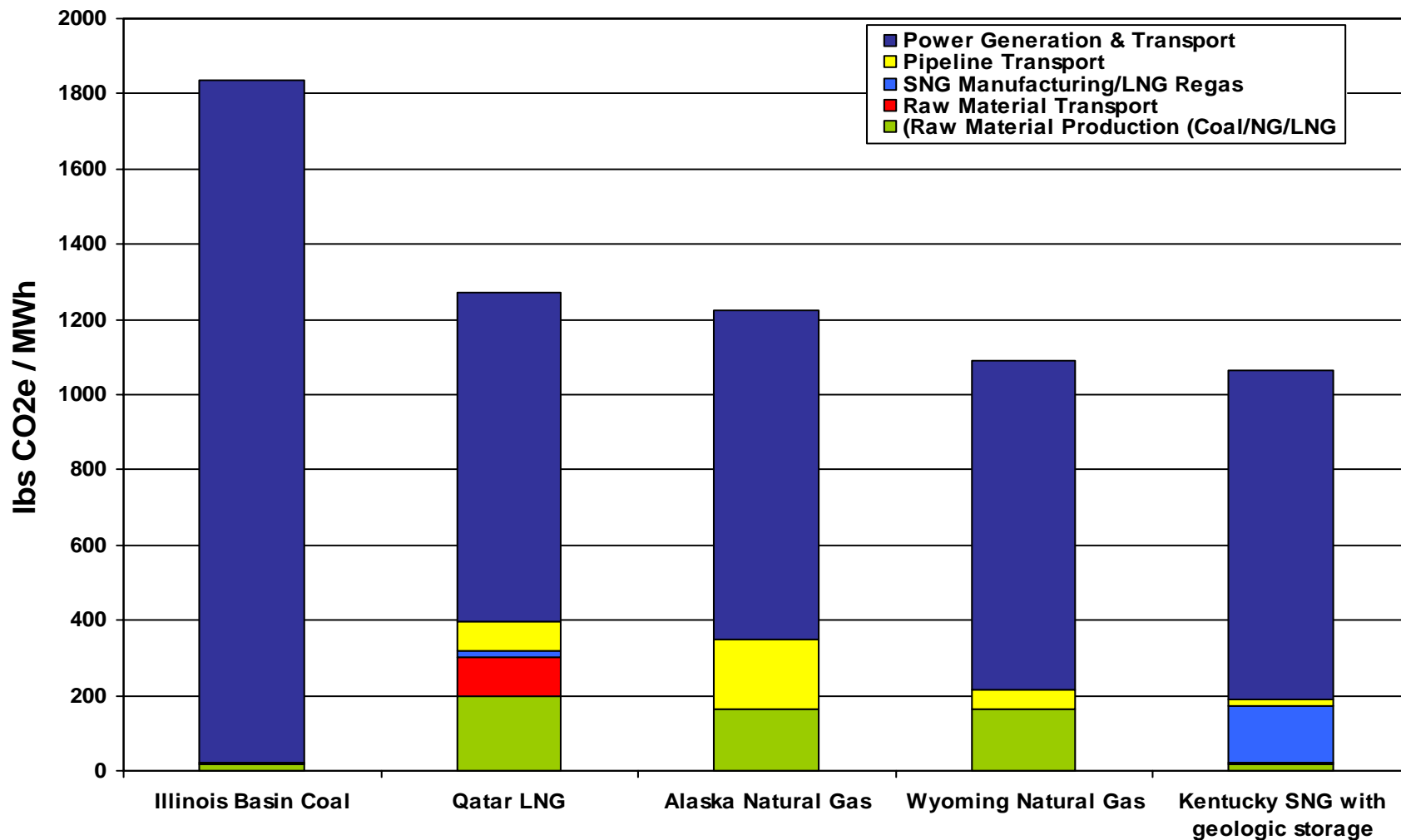

Electricity produced from the projects gas results in lower CO<sub>2</sub> emissions compared to other fossil fuels.

# North American Gasification Projects

2005-2008

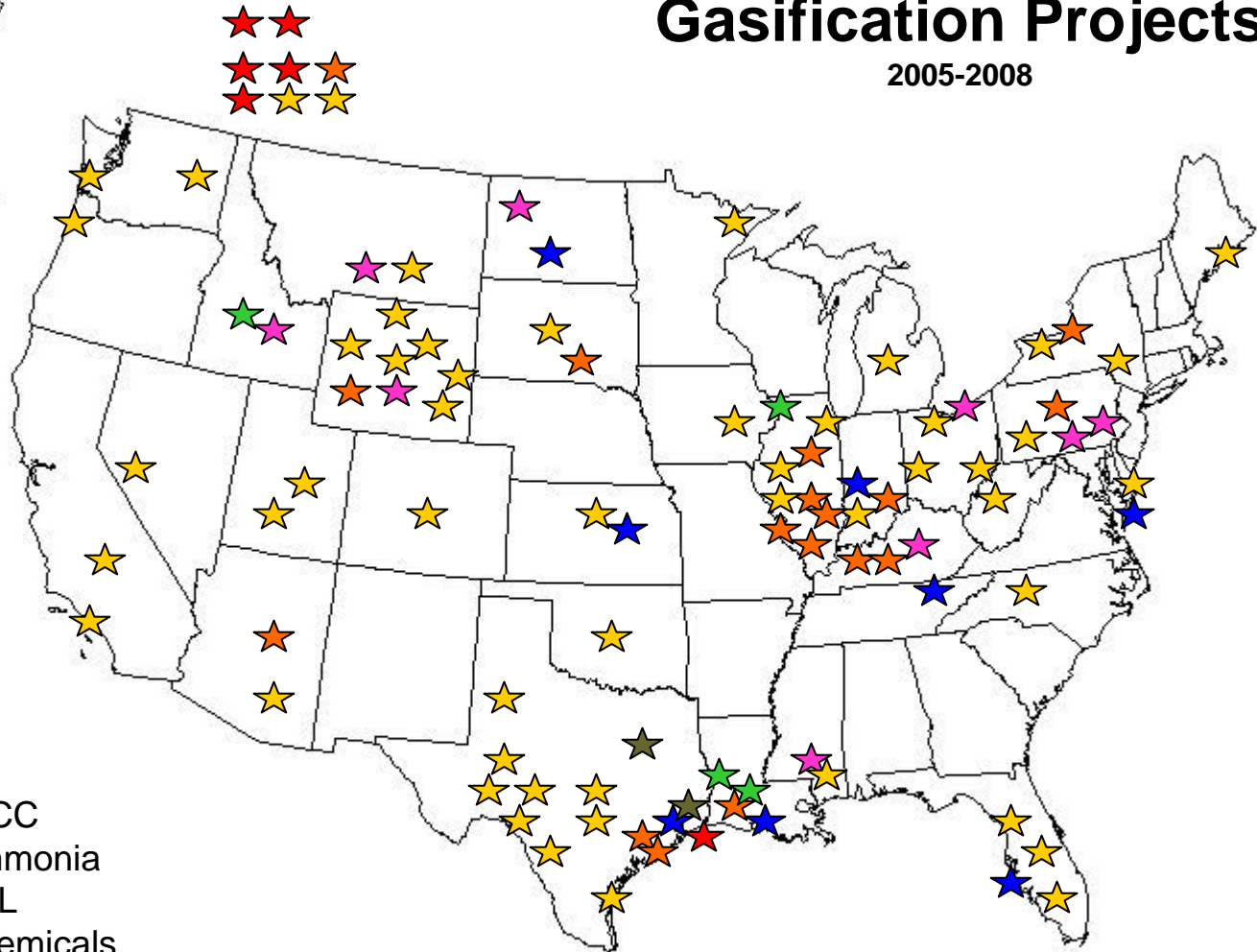

## Projects

- ★ IGCC
- ★ Ammonia
- ★ CTL
- ★ Chemicals
- ★ Hydrogen
- ★ SNG

★ Existing Gasification Facilities

Source: Gasification Technology Council

# North American Gasification Projects

Current Development Activity ?

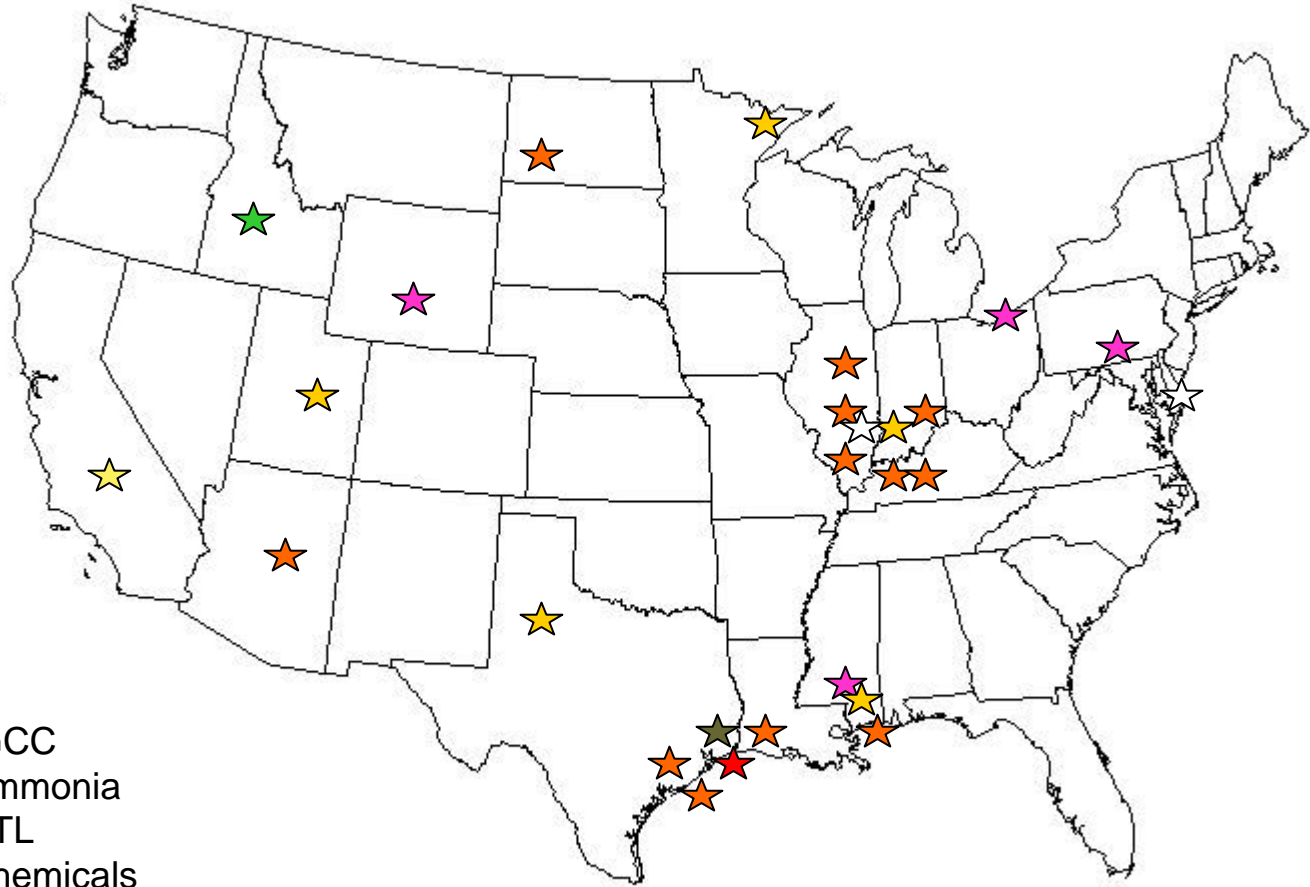

## Projects

- ★ IGCC
- ★ Ammonia
- ★ CTL
- ★ Chemicals
- ★ Hydrogen
- ★ SNG

# North American Gasification Projects

Current Development Activity ?

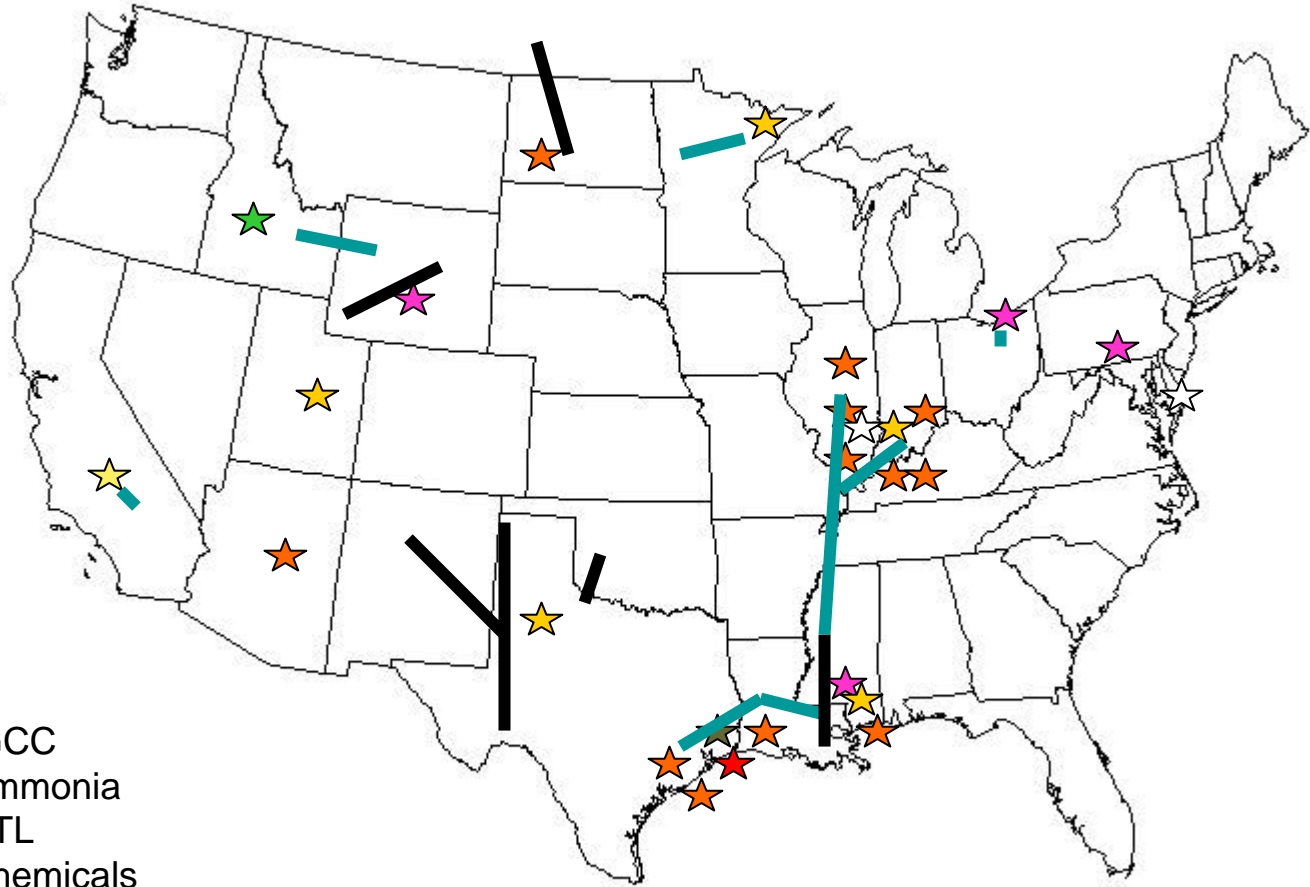

## Projects

- ★ IGCC
- ★ Ammonia
- ★ CTL
- ★ Chemicals
- ★ Hydrogen
- ★ SNG

General areas of existing and proposed CO2 pipelines

# Gasification The Enabling Technology



© 2015 Air Liquide

## Session 3.0

**Compressor Vendor  
Perspective on Changes in  
Compression Cycle, Machinery  
and CO<sub>2</sub> Capture System to  
Increase Energy Efficiency**

## Session 3.1

**Dresser-Rand Centrifugal and  
Reciprocating Compressor  
Technology And Experience with  
CO2 Compression Applications**

**Miller**



*Carbon Dioxide Compression*  
*DOE – EPRI – NIST*  
*Large CO<sub>2</sub> Compression Workshop*

By: Harry Miller  
Product Manager – Marketing  
March 30, 2009

**DRESSER-RAND.**



## *Safe Harbor Disclosure*



Some of the information contained in this document contains "forward-looking statements". In many cases, you can identify forward-looking statements by terminology such as "may," "will," "should," "expects," "plans," "anticipates," "believes," "estimates," "predicts," "potential," or "continue," or the negative of such terms and other comparable terminology. These forward-looking statements are only predictions and as such inherently included risks and uncertainties. Actual events or results may differ materially as a result of risks facing Dresser-Rand Company (D-R) or actual results differing from the assumptions underlying such statements. These forward-looking statements are made only as of the date of this presentation, and D-R undertakes no obligation to update or revise the forward-looking statements, whether as a result of new information, future events or otherwise. All forward-looking statements are expressly qualified in their entirety by the "Risk Factors" and other cautionary statements included in D-R's annual, quarterly and special reports, proxy statements and other public filings with the Securities and Exchange Commission and other factors not known to D-R. Your decision to remain and receive the information about to be presented to you shall constitute your unconditional acceptance to the foregoing.

## *Confidential & Proprietary*



Any person allowing themselves to directly or indirectly receive the information contained in this presentation (the "Receiver") agrees that this presentation and all information contained herein and/or in any way distributed to the Receiver with respect to the same (verbal or otherwise) is the confidential and proprietary property of Dresser-Rand Company and is being provided to and received by the Receiver in confidence. Receiver agrees not to divulge the contents hereof to any third party without the prior written approval of Dresser-Rand's duly authorized representative. Receiver shall advise any permitted recipient of the confidential information of the nature of the same and obtain their agreement to be bound to these terms before such confidential information is disclosed to them. Receiver on behalf of its principal, representatives, employees and themselves individually to hereby unconditionally agree to the terms hereof and agree to defend, indemnify, and hold Dresser-Rand harmless from and against any and all damages that result from Receiver's failure to strictly comply with these terms. Receiver further agrees that failure to comply with these terms will cause Dresser-Rand to suffer irreparable harm. Your decision to remain and receive the information about to be presented to you shall constitute your unconditional acceptance to the foregoing.

# CO<sub>2</sub> Compression Applications



- ◆ CO<sub>2</sub> pipeline transmission
- ◆ CO<sub>2</sub> production
- ◆ CO<sub>2</sub> injection - enhanced oil recovery
- ◆ Feedstock for urea & fertilizer plants
- ◆ Food & beverage processing
- ◆ Refrigerant, propellant, fire extinguishers
- ◆ *Greenhouse gas sequestration*

## *CO<sub>2</sub> Miscible Flooding*



- ◆ CO<sub>2</sub> Injection for EOR has a four-fold benefit
  - Lowers viscosity of the oil in place
  - Provides a measure of pressure drive
  - Can penetrate more types of rocks better than other enhancing agents
  - Leaves a cleaner well

# CO<sub>2</sub> Miscible Flooding

*continued...*



- ◆ CO<sub>2</sub> injection proven to be one of the most efficient EOR methods since its introduction in the early 70's.

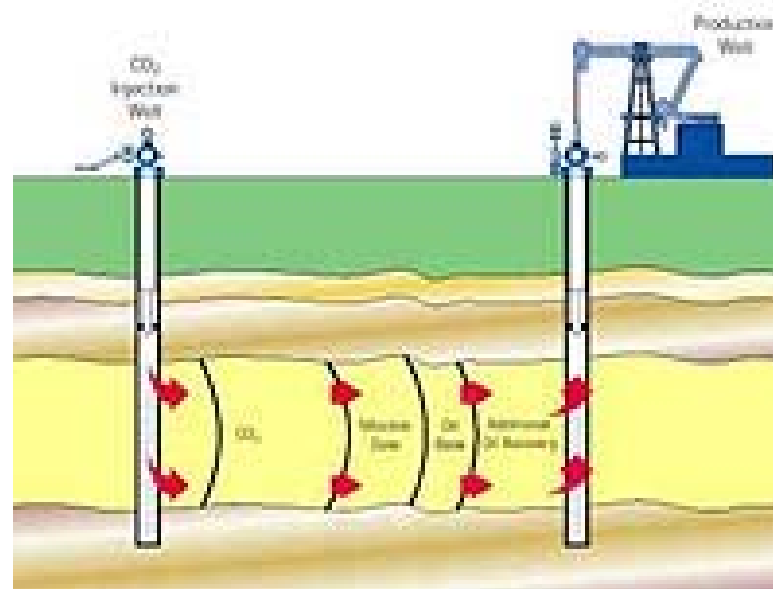

# CO<sub>2</sub> Compression Experience



## ◆ Centrifugal

- More than 100 units, first shipped in 1948, most recent 2009
- Max discharge pressure;
  - more than 2,500psia (175 bar) operating
  - more than 4,400psia (300 bar) - delivery 200
- Installed in 16 different countries
- Max inlet flow greater than 48,000 acfm (82,000 m<sup>3</sup>/hr)
- Max power greater than 15,000 bhp (11,000 kW)
- Total installed power > 400,000 bhp (>300MW)

# *D20R4S CO<sub>2</sub> Booster Rotor & Internal Flowpath*



**DRESSER-RAND**

# *CO<sub>2</sub> EOR Recycle Unit - Canada*



**DRESSER-RAND®**



# *Sleipner CO<sub>2</sub> Injection Compressor*

- ◆ First CO<sub>2</sub> re-injection project for the purpose of mitigating greenhouse emissions
- ◆ 9 million tons CO<sub>2</sub> injected



*Harald Underbakke*



# Sleipner CO<sub>2</sub> Injection Compressor

*continued...*

- ◆ Objective: reduce the CO<sub>2</sub> content from 9% to 2.5% (sale spec.)
- ◆ Capture the CO<sub>2</sub> by an amin plant
- ◆ CO<sub>2</sub> storage in an aquifer
- ◆ Start up: Aug 1996
- ◆ Injection: ~ 1 mill ton CO<sub>2</sub>/yr
- ◆ Regularity: 98-99%

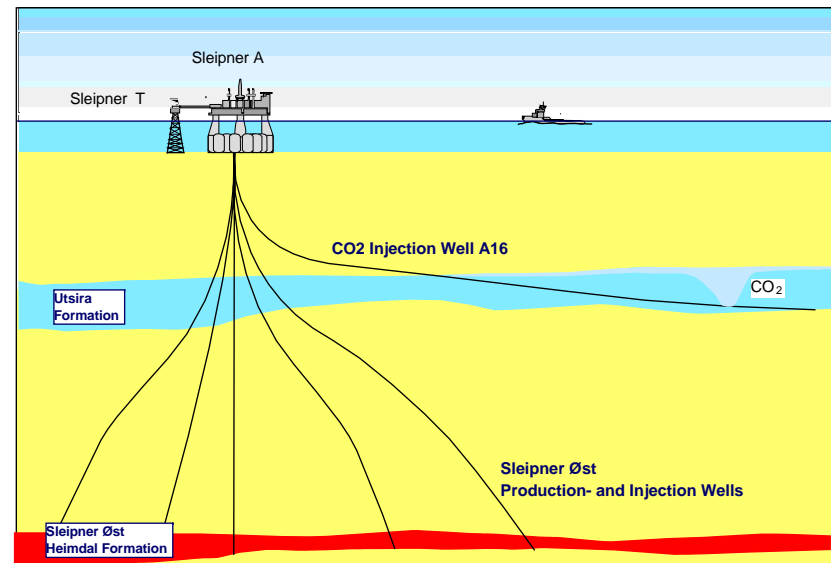

# CO<sub>2</sub> Compression and Injection Systems

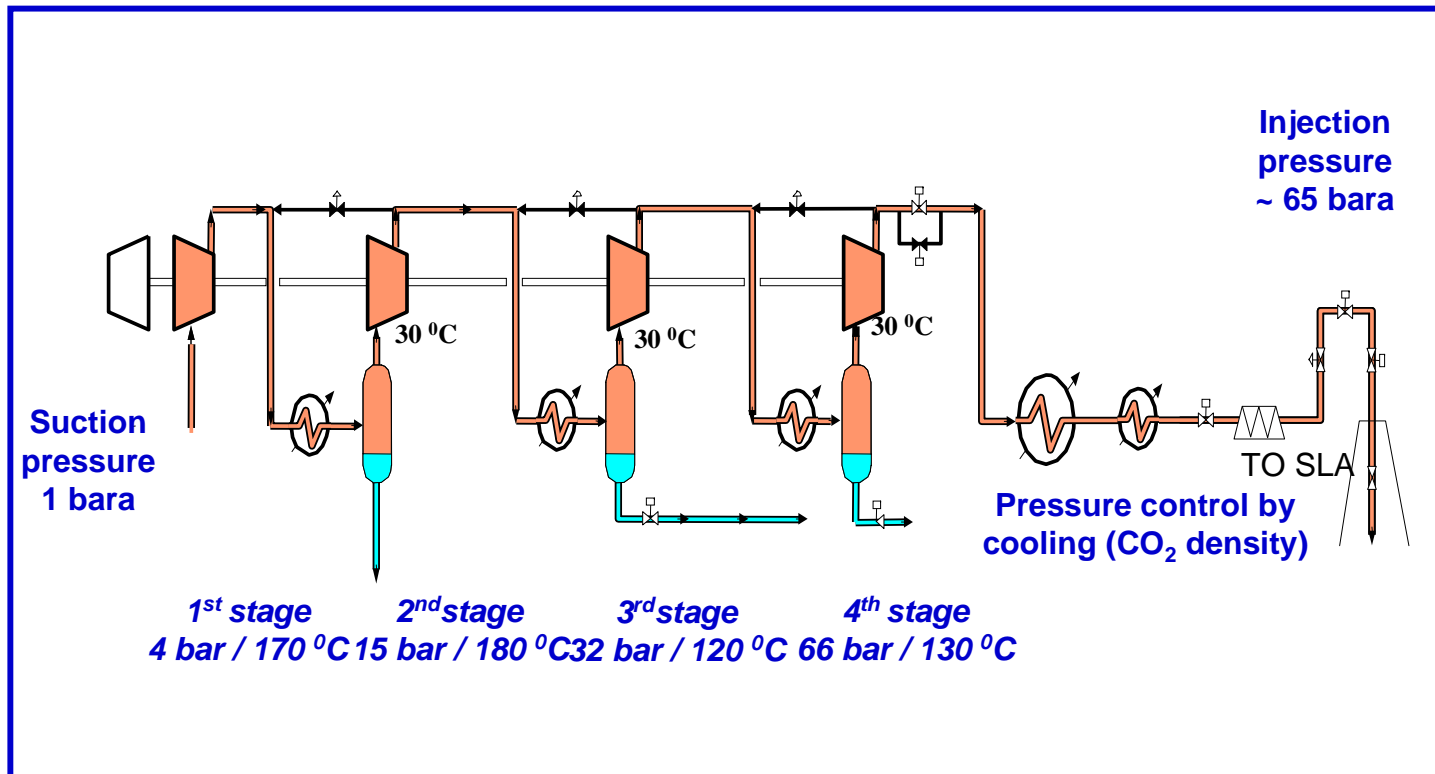

# Compressor General Arrangement

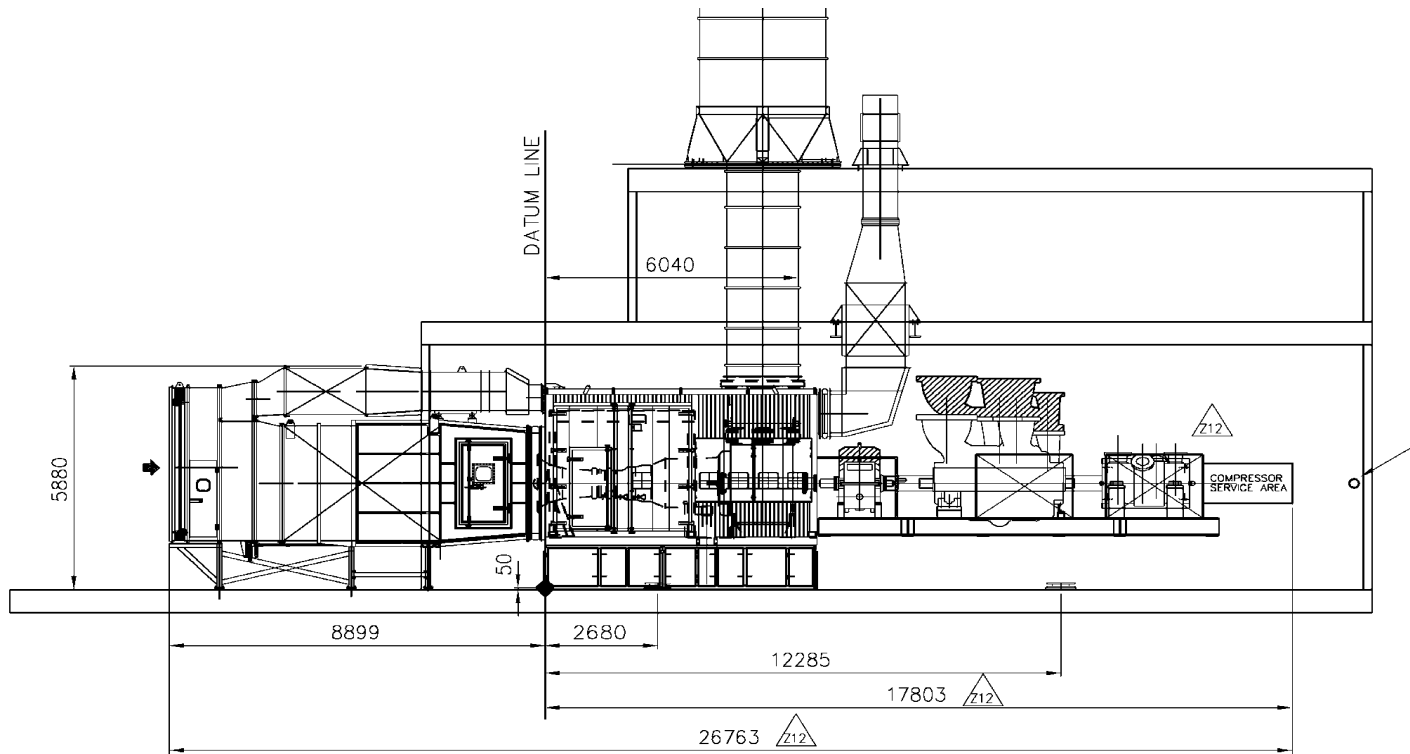

Special Information: Is the property of Dresser-Rand A/S and is credited to the supplier

# *Platform and Injection Module*

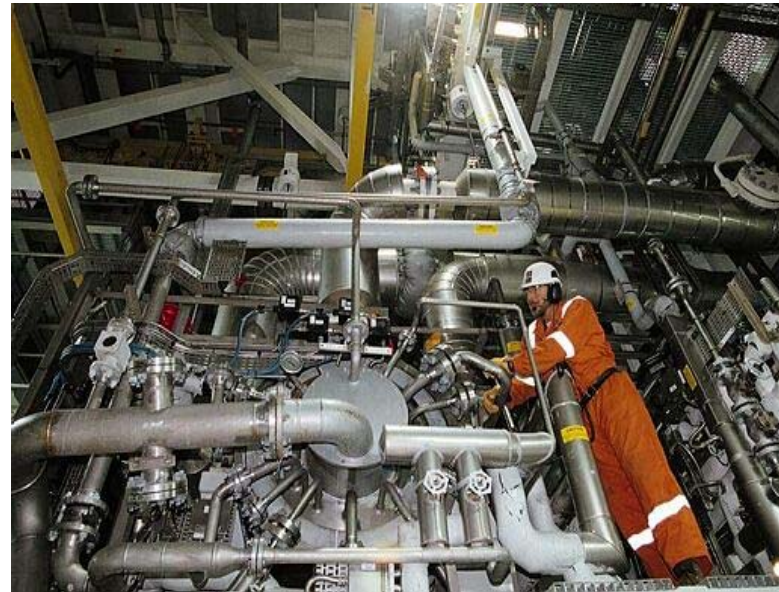

**DRESSER-RAND®**

# 1<sup>st</sup> and 2<sup>nd</sup> Stage Compressor



**DRESSER-RAND®**

 **STATOIL**

# D-R High Pressure CO<sub>2</sub> Application

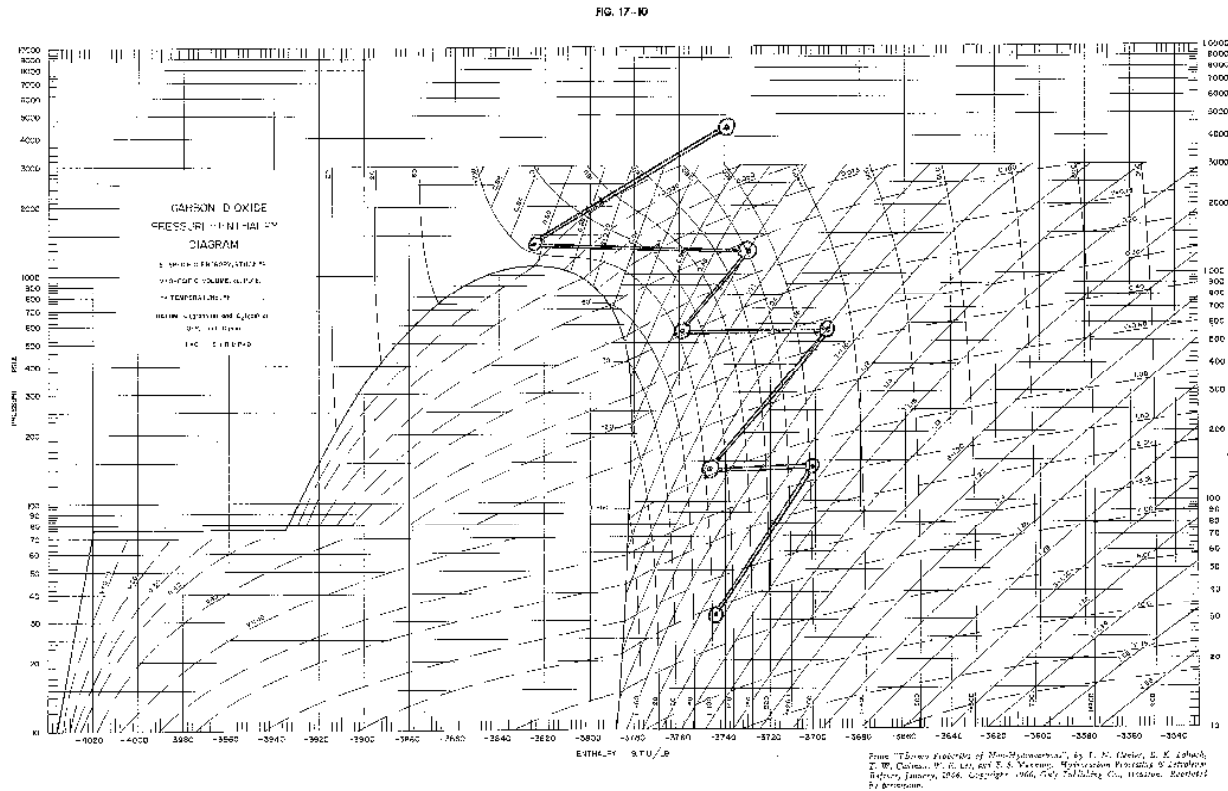

4472 psia final pressure

17-13

# *CO<sub>2</sub> Phase Diagram*

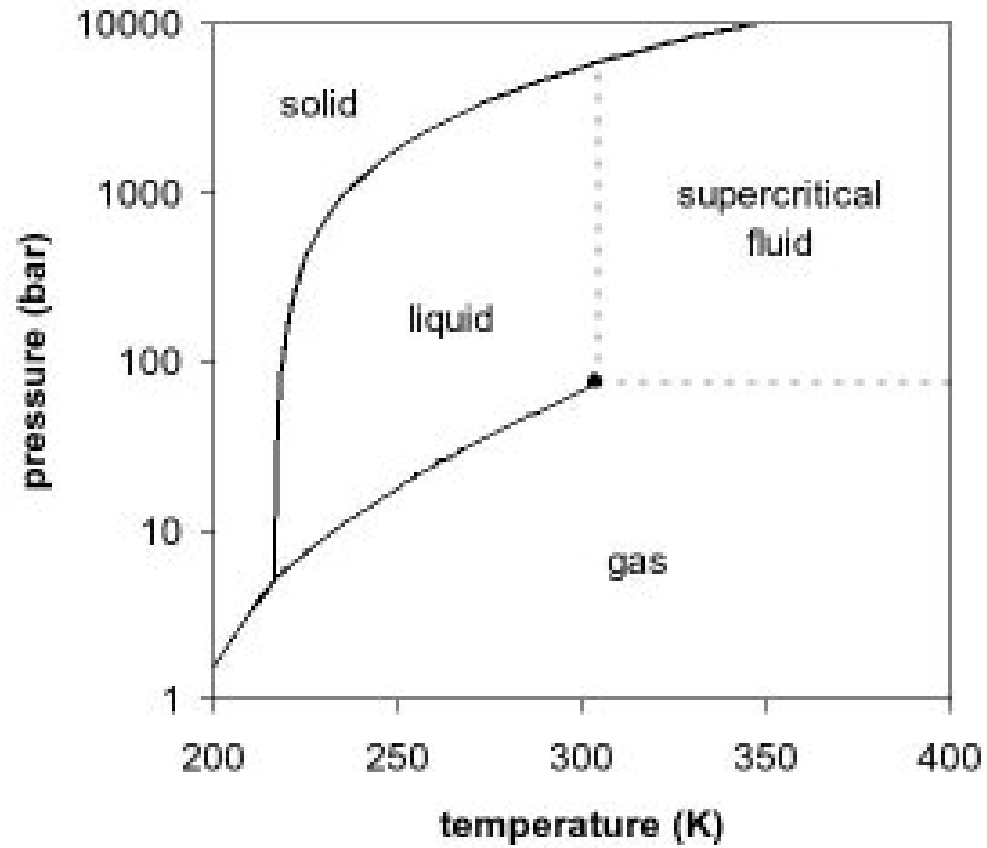



# CO<sub>2</sub> Sealing Gas Phase Map

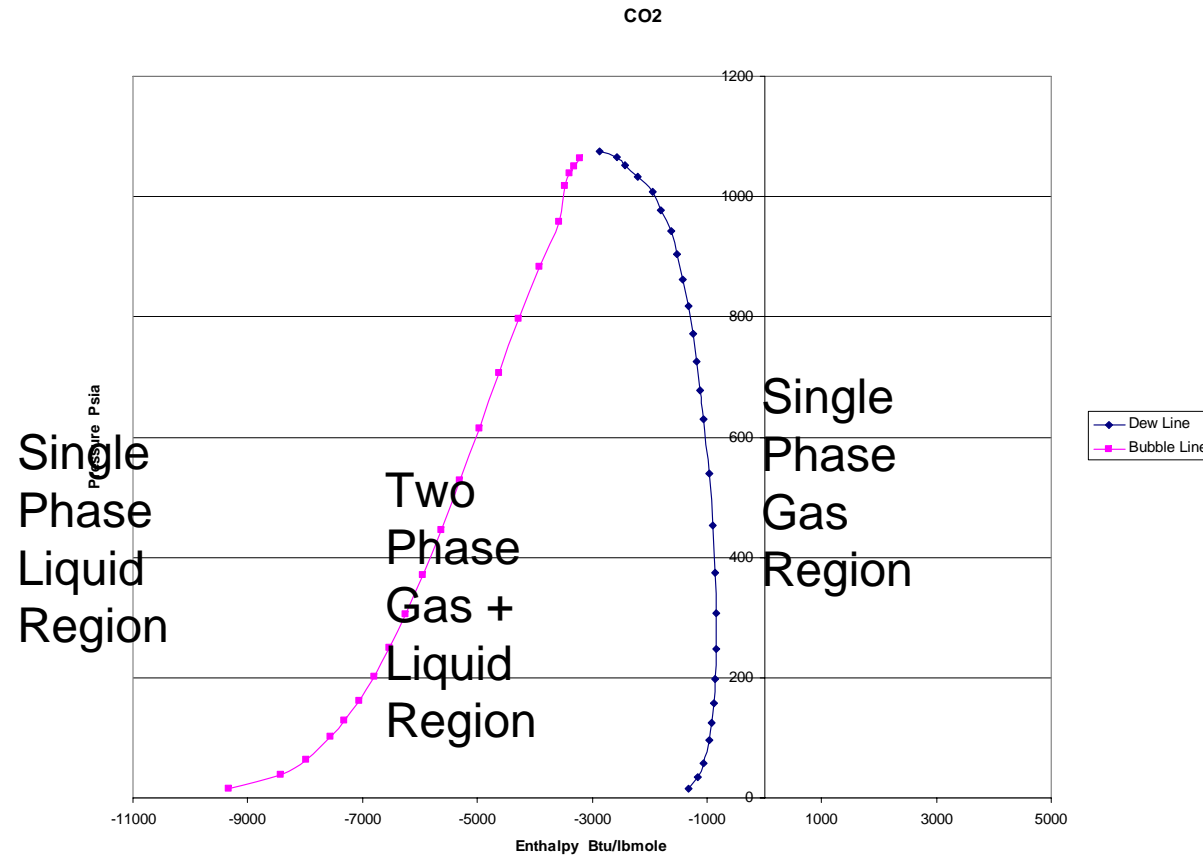

# DATUM CO<sub>2</sub> Predicted vs. Actual Performance

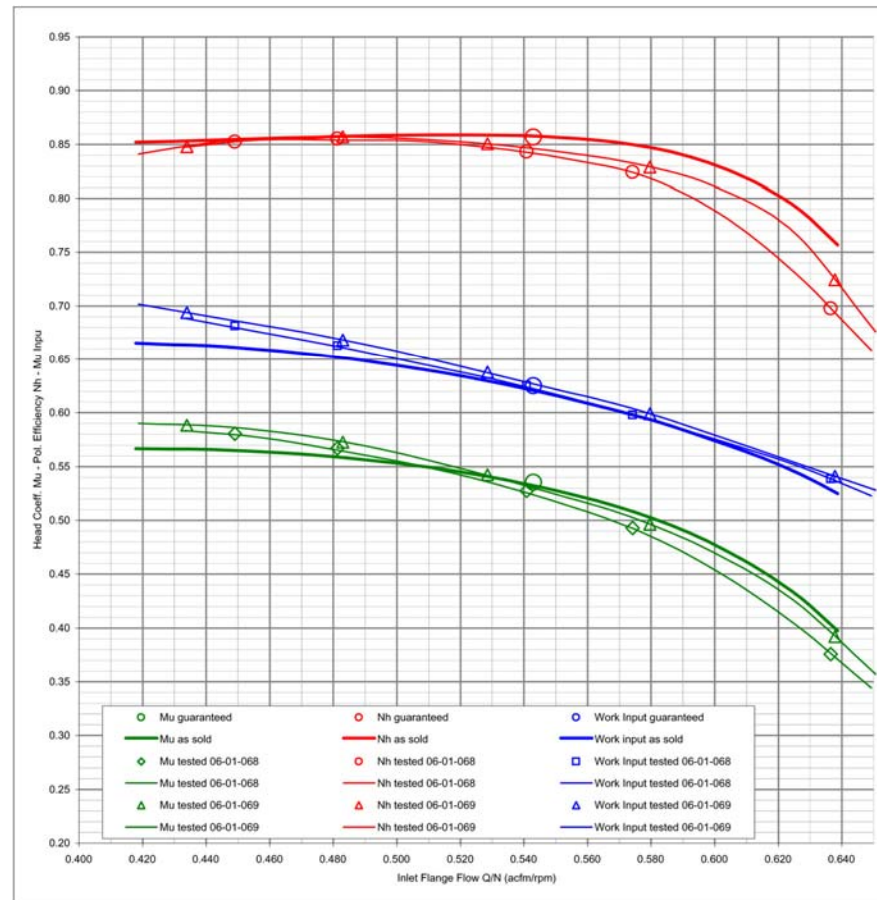

# *D-R Shaft End Seals - Dry Gas Seals*

- ◆ Minimum leakage - approx. 1 scfm
- ◆ Requires seal gas supply
  - Normally comes from compressor discharge
  - Alternate supply source is usually required for start-up
- ◆ D-R manufactures their own high-quality gas seals

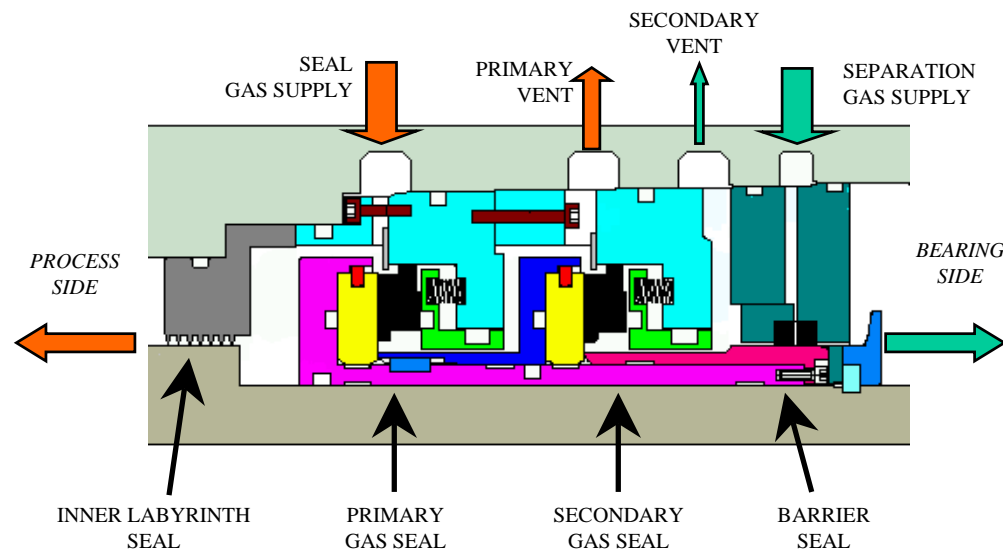

# *CO<sub>2</sub> Compression Experience*



## ◆ Reciprocating

- more than 200 units, first shipped in 1928, most recent 2007
- Max discharge pressure - more than 6000 psig (425 bar)
- Max inlet flow - more than 4000 acfm (7,000 m<sup>3</sup>/hr)
- Max power - greater than 5,000 bhp (4,000 kW)
- Total installed power > 530,000 bhp (>395MW)

# *Process Reciprocating Compressor*

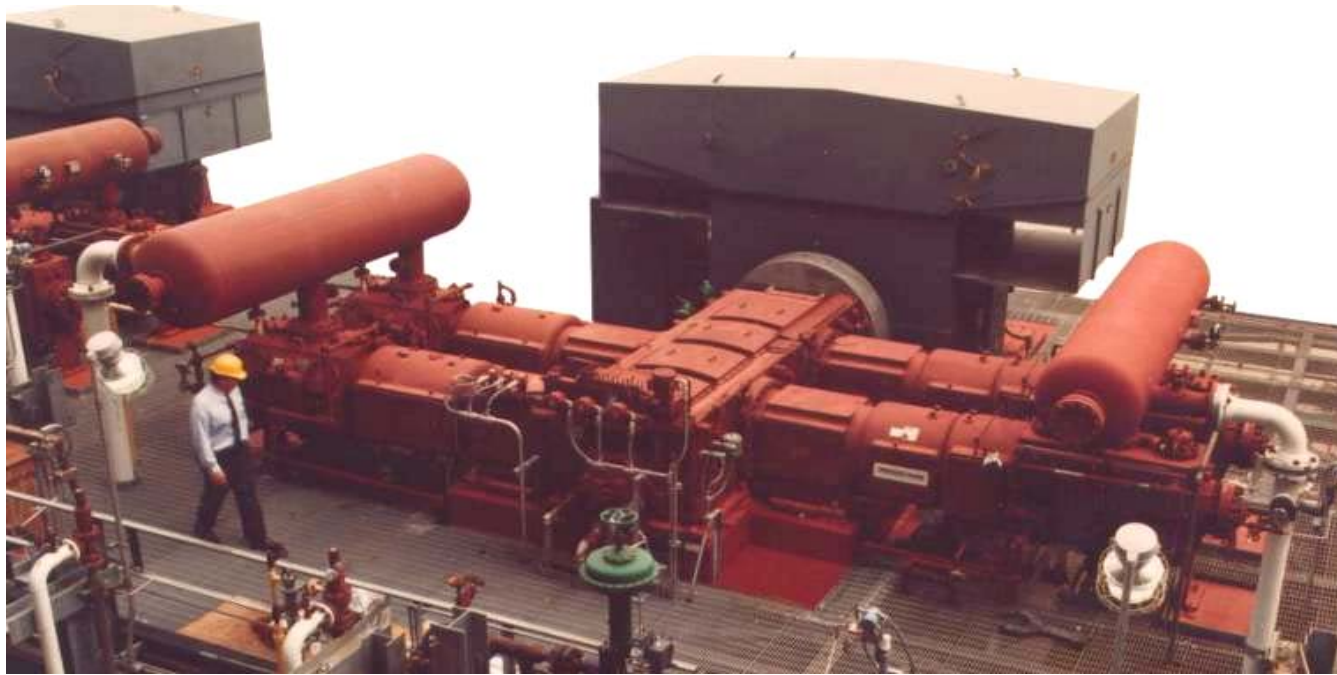

**5,500 HP HHE-VL Process Reciprocating Compressor on Hydrogen Makeup Service in USA Gulf Coast Refinery**

## *Challenges with CO<sub>2</sub> Compression*

- ◆ The presence of water together with CO<sub>2</sub> creates carbonic acid which is corrosive to carbon steels. The use of stainless steel for any components in contact with wet CO<sub>2</sub> eliminates the problem.
- ◆ Similarly, the presence of water with CO creates iron carbonyl upon contact with carbon steel. Again, the use of stainless steels for solves the problem.
- ◆ Special O-ring materials required to resist explosive decompression due to entrapped CO<sub>2</sub>.

## *Toxic Effects of H<sub>2</sub>S*



- ◆ 1 PPM smell
- ◆ 10 PPM 8 hr. TWA
- ◆ 100 PPM loss of smell
- ◆ 300 PPM loss of consciousness with time (~ 30 min.)
- ◆ 1000 PPM immediate respiratory arrest, loss of consciousness, followed by death

## *Future Considerations...*

- ◆ Increasing the amount of inter-stage cooling will reduce the overall power required for CO<sub>2</sub> compression.
- ◆ Advanced inter-stage cooling concepts are being investigated to improve the effectiveness of existing water-cooled stationary diaphragms.
- ◆ D-R working with SwRI on DOE-NETL funded project to develop advanced inter-stage cooling for traditional multi-stage inline centrifugal compressors.
- ◆ D-R supporting RAMGEN supersonic compression development.





## ***High Capacity and High Power Compressor Experience***

# DATUM Product Flexibility

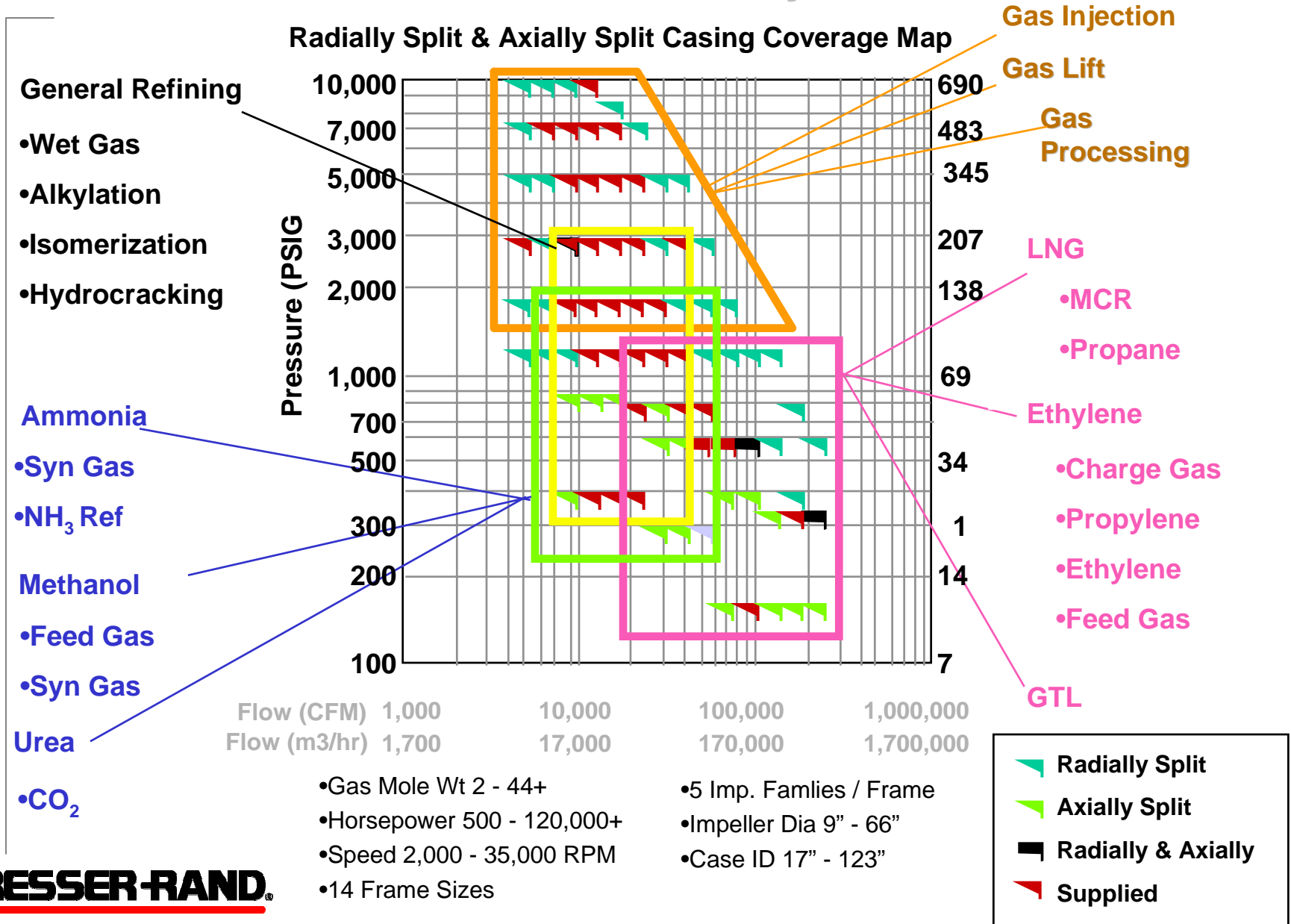

**DRESSER-RAND**

# DATUM Product Flexibility

Radially Split & Axially Split Casing Coverage Map

CO<sub>2</sub>  
Experience  
To Date

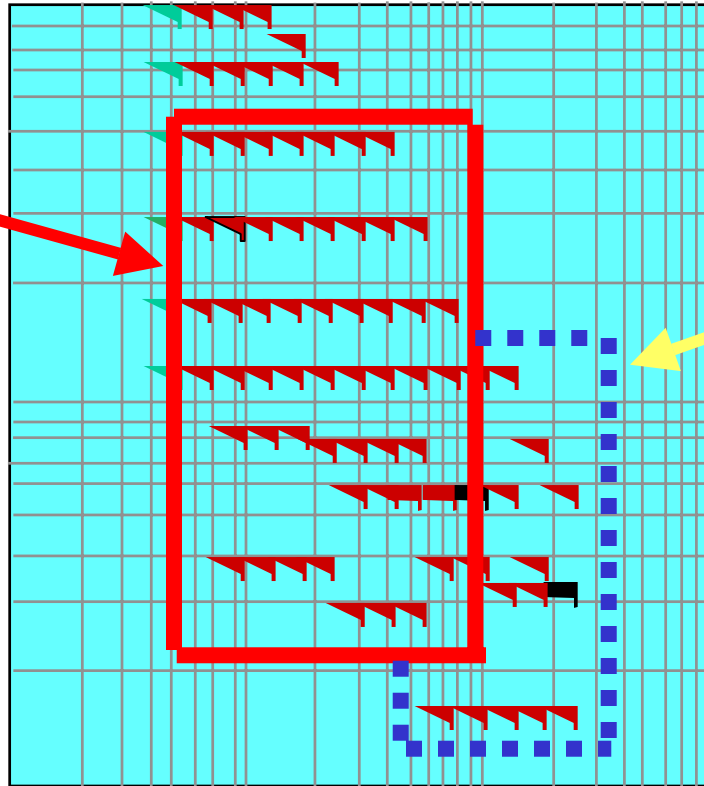
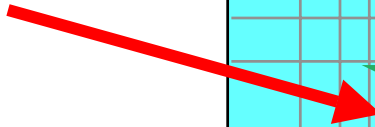

Future  
Full-Size  
IGCC,  
Oxy-Coal,  
& PC CCS  
Applications

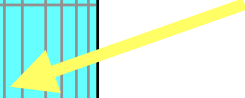

Flow (CFM)	1,000	10,000	100,000	1,000,000
Flow (m3/hr)	1,700	17,000	170,000	1,700,000

- Gas Mole Wt 2 - 44+
- Horsepower 500 - 120,000+
- Speed 2,000 - 35,000 RPM
- 14 Frame Sizes

- 5 Imp. Families / Frame
- Impeller Dia 9" - 66"
- Case ID 17" - 123"

	Radially Split
	Axially Split
	Radially & Axially
	Supplied

**DRESSER-RAND**

# *LNG Liquefaction Compressors*

## *Large Trains = Large Casings*

Over (100) Dresser-Rand compressors are in liquefaction services. Nine (9) of these very large Dresser-Rand vertically split compressors are operating in propane refrigeration service.



*DATUM D26R9B Rotor (background) +  
D10R9B Rotor (foreground)*

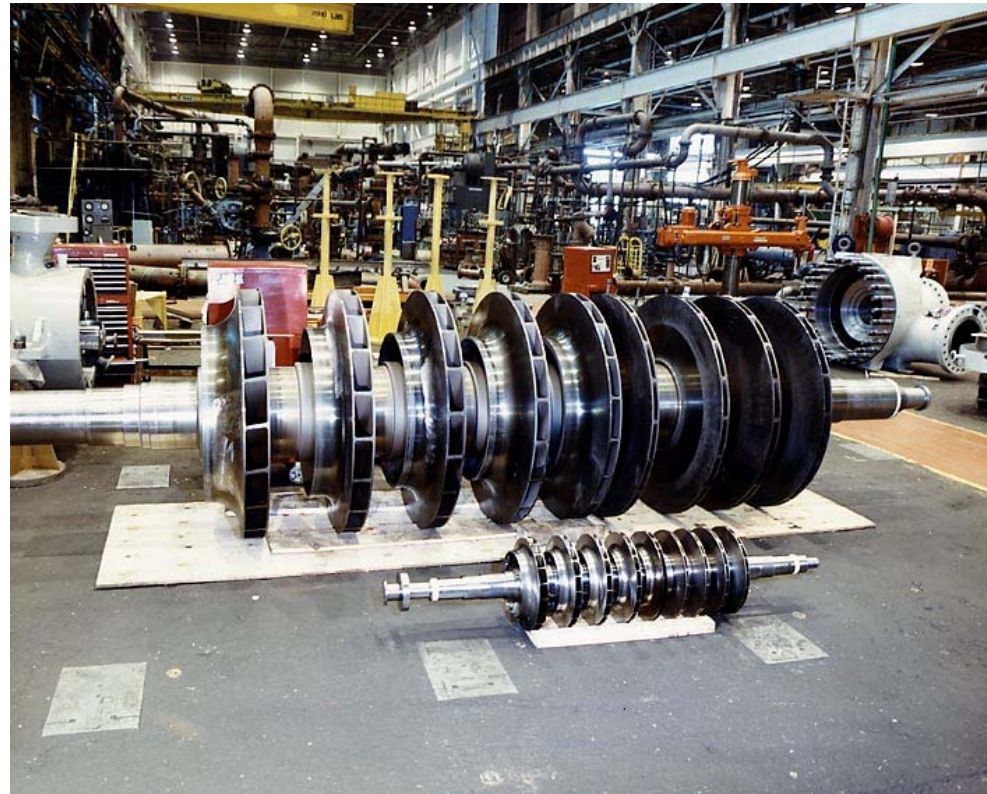

# *DATUM D26R9B*



**DRESSER-RAND®**

# *DATUM & RR Trent on Test 52 MW Rating at ISO Conditions*



# *DATUM - Trent Train on Test 52 MW Rating at ISO Conditions*





## *DATUM - Trent Installed at Site*



## *RR Trent Enclosure*



# *DATUM D22R7S + GE LM6000*

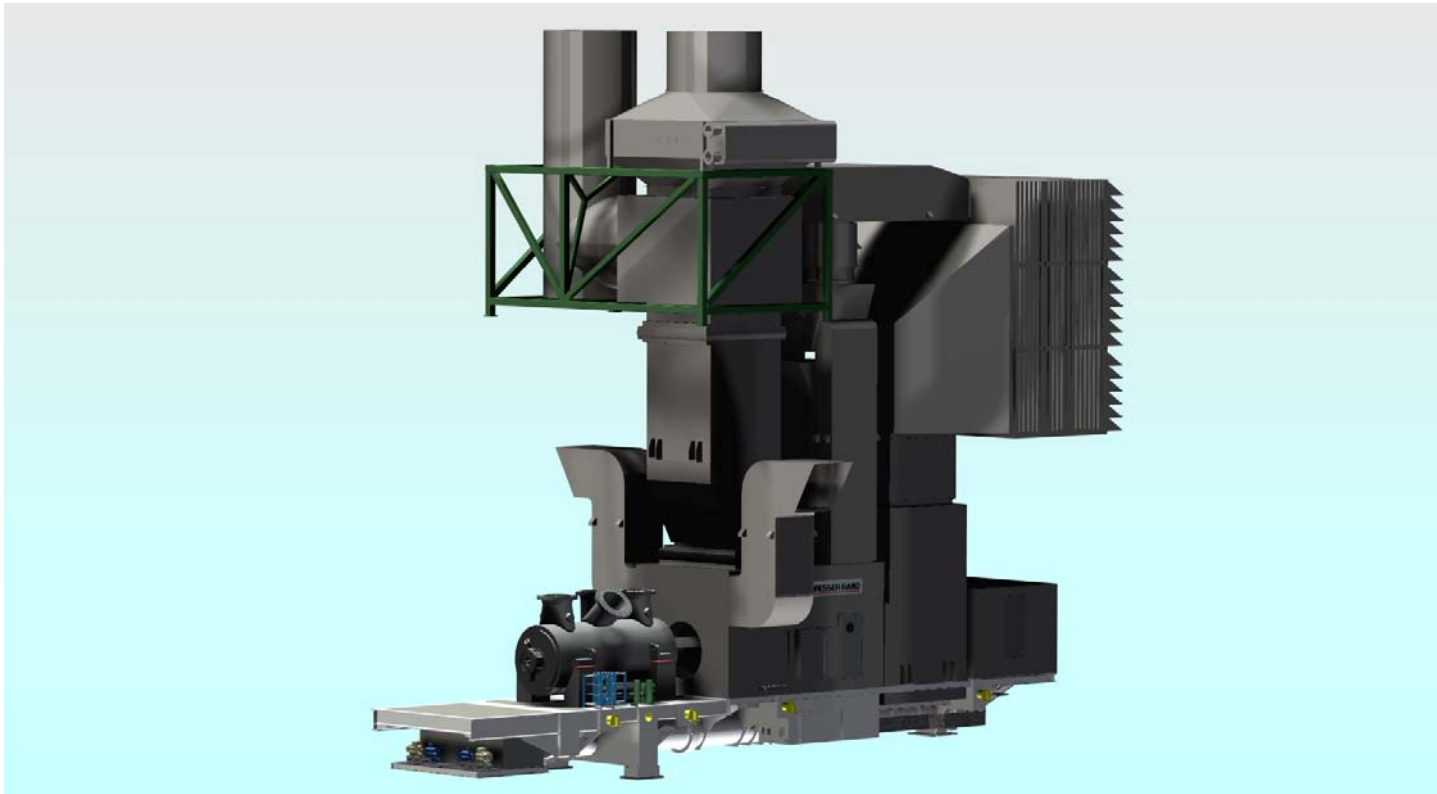

# *D-R Compressor Driven by 42MW VFD Motor*



# 110MW McIntosh CAES Installation



# *D-R CAES Single Train Arrangement*

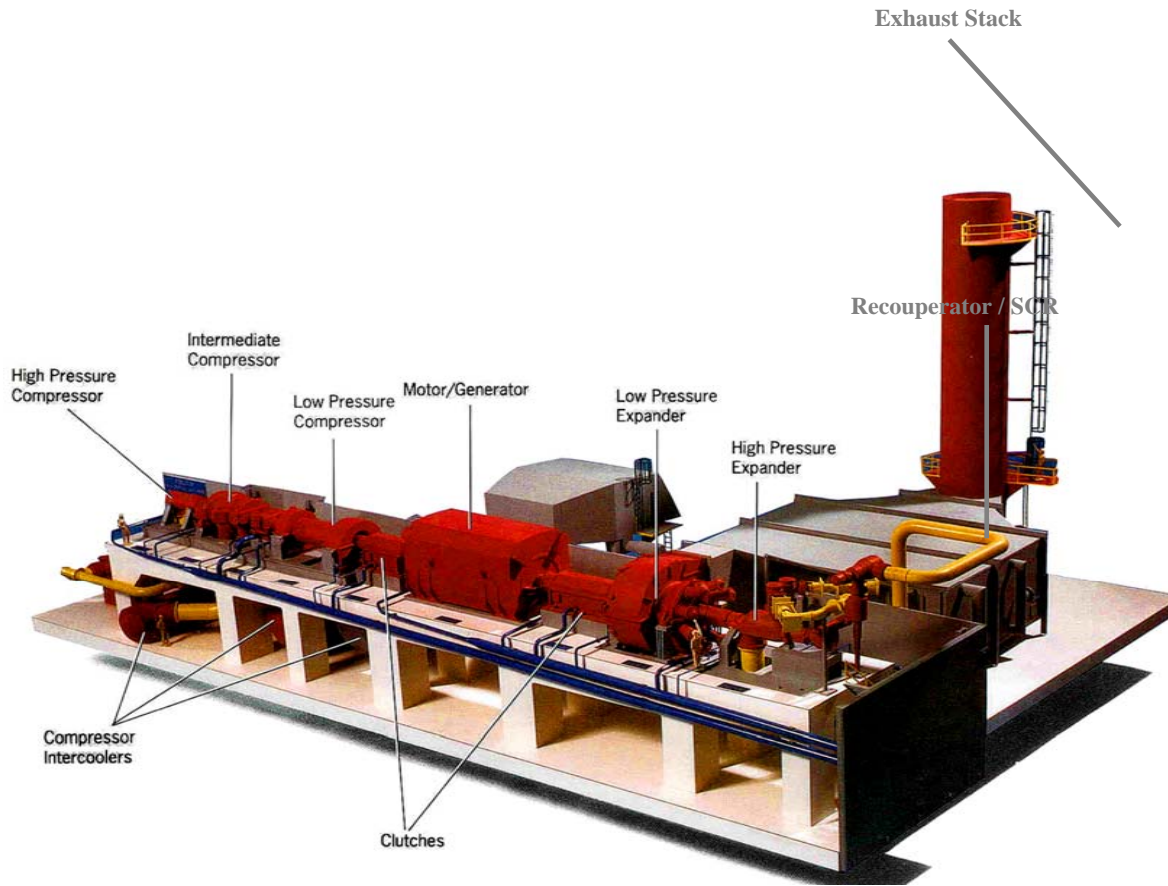

## *D-R High Power Driver Experience*

- ◆ GE Frame 7
- ◆ GE Frame 6
- ◆ GE LM6000
- ◆ RR Trent
- ◆ ABB Electric Motor
- ◆ EM (Converteam) Electric Motor/Generator
- ◆ Steam Turbines up to 70,000 bhp



*Thank You !*

*Questions?*





[www.dresser-rand.com](http://www.dresser-rand.com)  
[info@dresser-rand.com](mailto:info@dresser-rand.com)

**DRESSER-RAND.**

## Session 3.2

**Compressors for High  
Pressure CO<sub>2</sub> Compression  
Applications**  
Kisor



# MAN Turbo

Engineering the Future –  
Since 1758.

# The MAN Group

250 Years MAN



250 years of experience, knowledge, competence

250 years of innovation, technology and progress

250 years of reliability, profitability and economic success

250 years

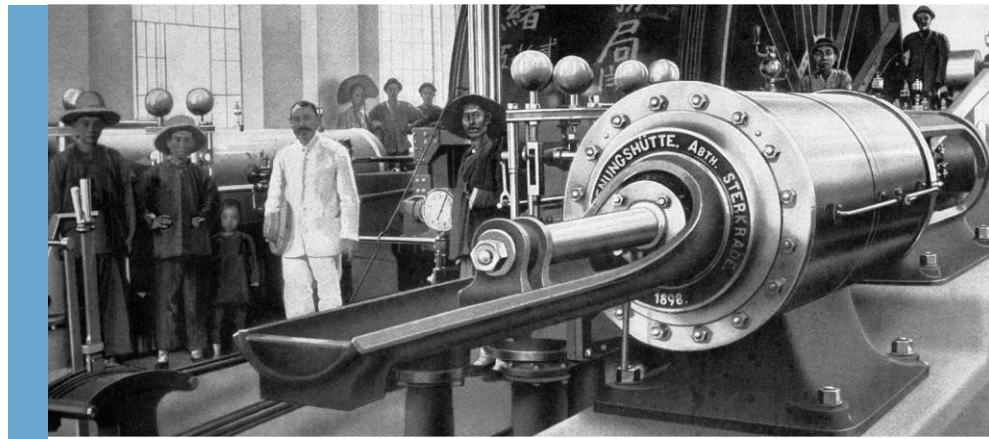

# Milestones



- |             |  |             |  |
|-------------|--|-------------|--|
| <b>1758</b> | Founding of the St. Antony iron works  | <b>1952</b> | Production of GHH screw compressors  |
| <b>1782</b> | Establishment „Gute Hoffnungshütte“ (GHH) steel in Sterkrade                   | <b>1977</b> | First BORSIG Multi-shaft compressor  |
| <b>1805</b> | Establishment of the Sulzer-Escher Wyss mechanical engineering works of Zurich | <b>1991</b> | Development of the MOPICO sealed turbocompressor product line  |
| <b>1814</b> | Start of GHH steam engine production   | <b>1994</b> | Delivery of the first FT8 industrial gas turbine made by GHH   |
| <b>1857</b> | First BORSIG compressors   | <b>1996</b> | Establishment of GHH BORSIG Turbomaschinen GmbH (integration of the turbocompressor activities of Deutsche Babcock AG) |
| <b>1877</b> | Establishment of Blohm+Voss Shipbuilding                                       | <b>2001</b> | Takeover of the Sulzer AG turbomachinery activities by MAN Turbomaschinen AG GHH BORSIG                                |
| <b>1903</b> | First Sulzer turbocompressor   | <b>2004</b> | New centre for the assembly and testing of large machine sets  |
| <b>1904</b> | First GHH steam turbine  | <b>2006</b> | Integration of MAN DWE GmbH into MAN Turbo Group   |
| <b>1906</b> | Start of Blohm & Voss steam turbine production                                 | <b>2006</b> | Acquisition of steam turbine division of B+V Industrietechnik GmbH   |
| <b>1915</b> | First process-gas turbine and first isotherm compressor                        |             |  |
| <b>1934</b> | First Sulzer axial compressor (air blower)                                     |             |  |
| <b>1950</b> | First GHH axial compressor   |             |  |



# Company Headquarters & Main Locations Berlin



**Employees (28.02.2009) : 522**

## Products

Division  
Oil & Gas



Small / medium  
centrifugal  
compressors



Multi-shaft  
compressors

## Competence centre for:

- Refining & CO<sub>2</sub> Applications

# Locations

## Sales and Service Centres

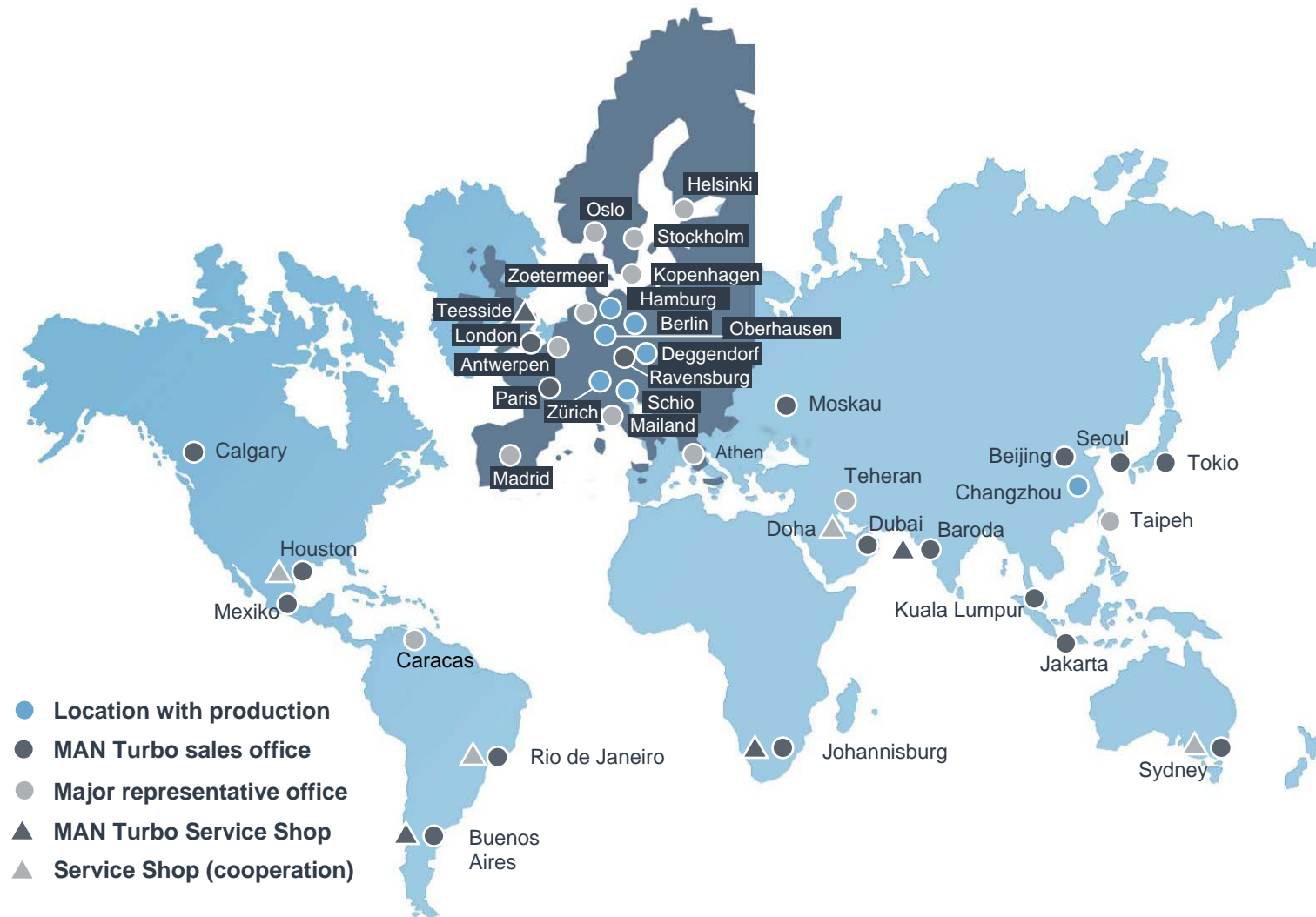

# Compressors

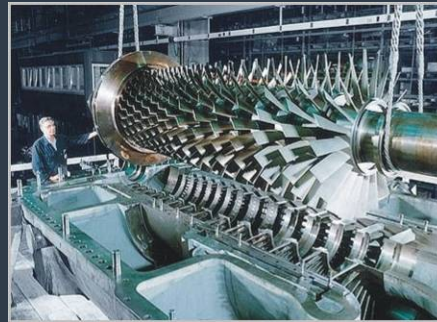

- Axial compressors
- Integrally geared compressors
- Isotherm compressors
- Pipeline compressors
- Process-gas screw compressors
- Centrifugal compressors
- Vacuum blowers
- MOPICO / HOFIM



# Compressors

## Technical data



<b>Turbo-compressors</b>	<b>Max. suction flow rate (m³/h)</b>	<b>Max. discharge pressure (bar)</b>
Axial compressors	1 500 000	25
Single-shaft centrifugal compressors, horizontally split	660 000	80
Single-shaft centrifugal compressors, vertically split	230 000	300
High-pressure barrel compressors	35 000	1 000
Multi-shaft centrif. compressors	350 000	225
Isotherm compressors	660 000	20
TURBAIR® vacuum blowers	200 000	Vakuum
Pipeline compressors	85 000	130
<b>Process-gas screw compressors</b>	<b>Max. suction flow rate (m³/h)</b>	<b>Max. discharge pressure (bar)</b>
Screw compressors	100 000	50

# Integrally-gearred compressor



- Suction flow rates up to 350,000 m<sup>3</sup>/h
- Max. discharge pressure up to 225 bar

- Ammonia
- Fuel gas
- CO<sub>2</sub> compression
- Fluid catalytic cracking
- Urea
- Air separation
- Refinery / Petrochemicals
- Nitric acid
- Oxygen
- Terephthalic acid

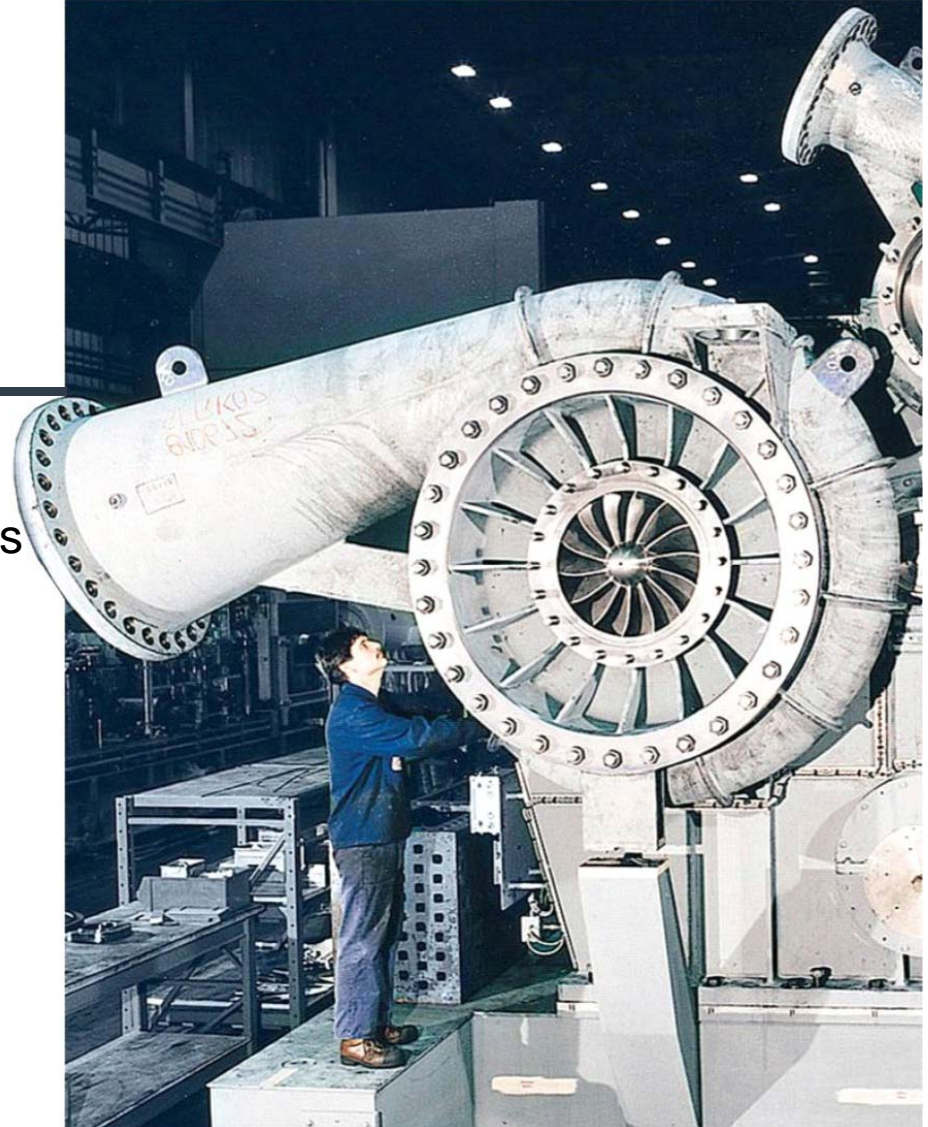

# Integrally-Geared Centrifugal History

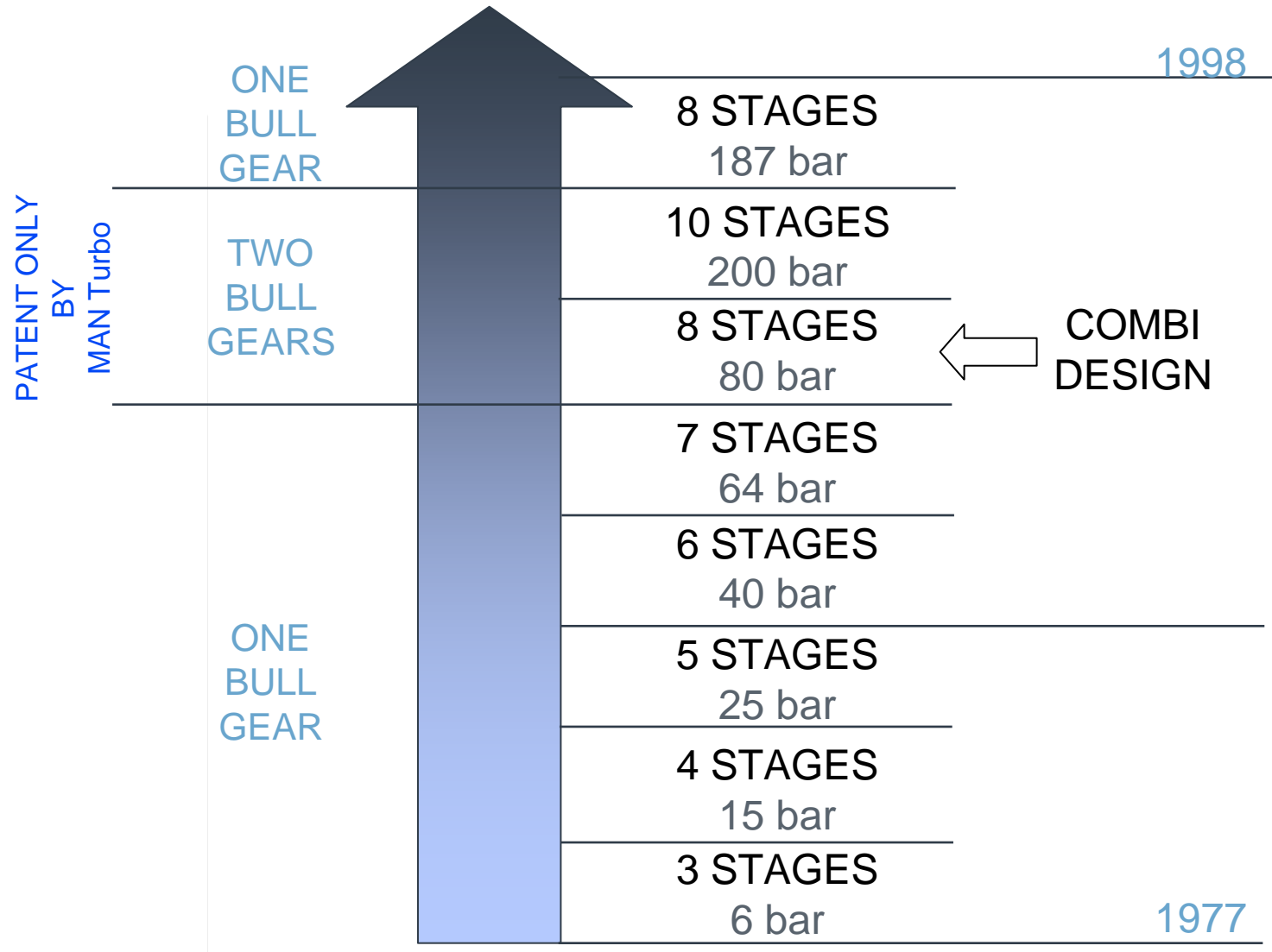

# Integrally-Geared Centrifugal

## Basic Design



### Typical 4-Stage Arrangement

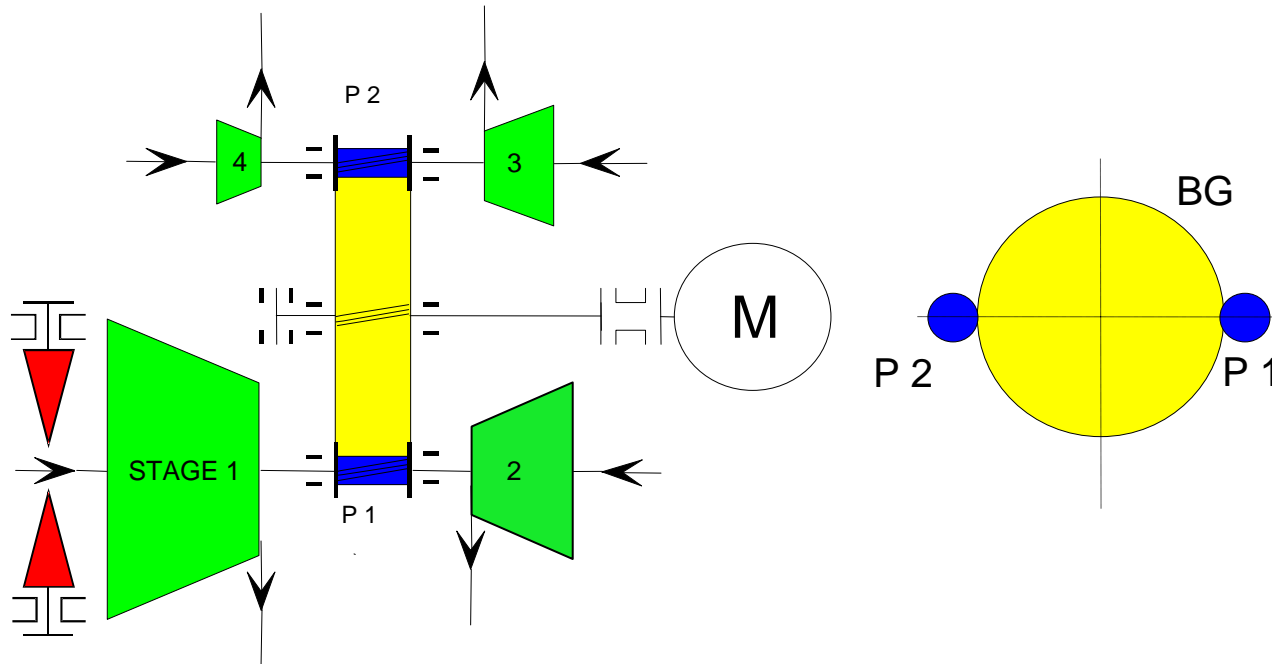

# Integrally-Geared Centrifugal

## Basic Design

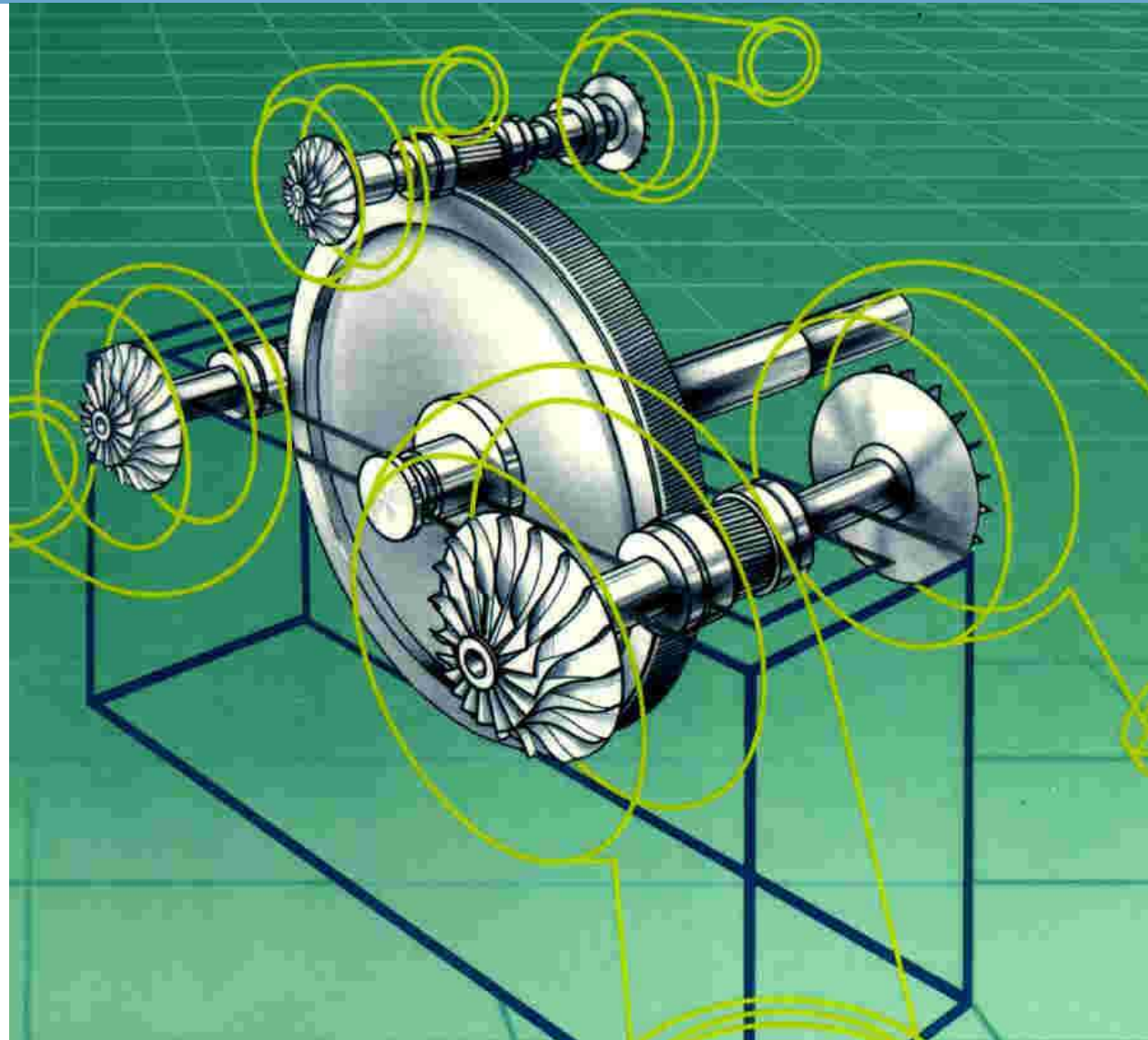

# Integrally-Geared Centrifugal

## Basic Design

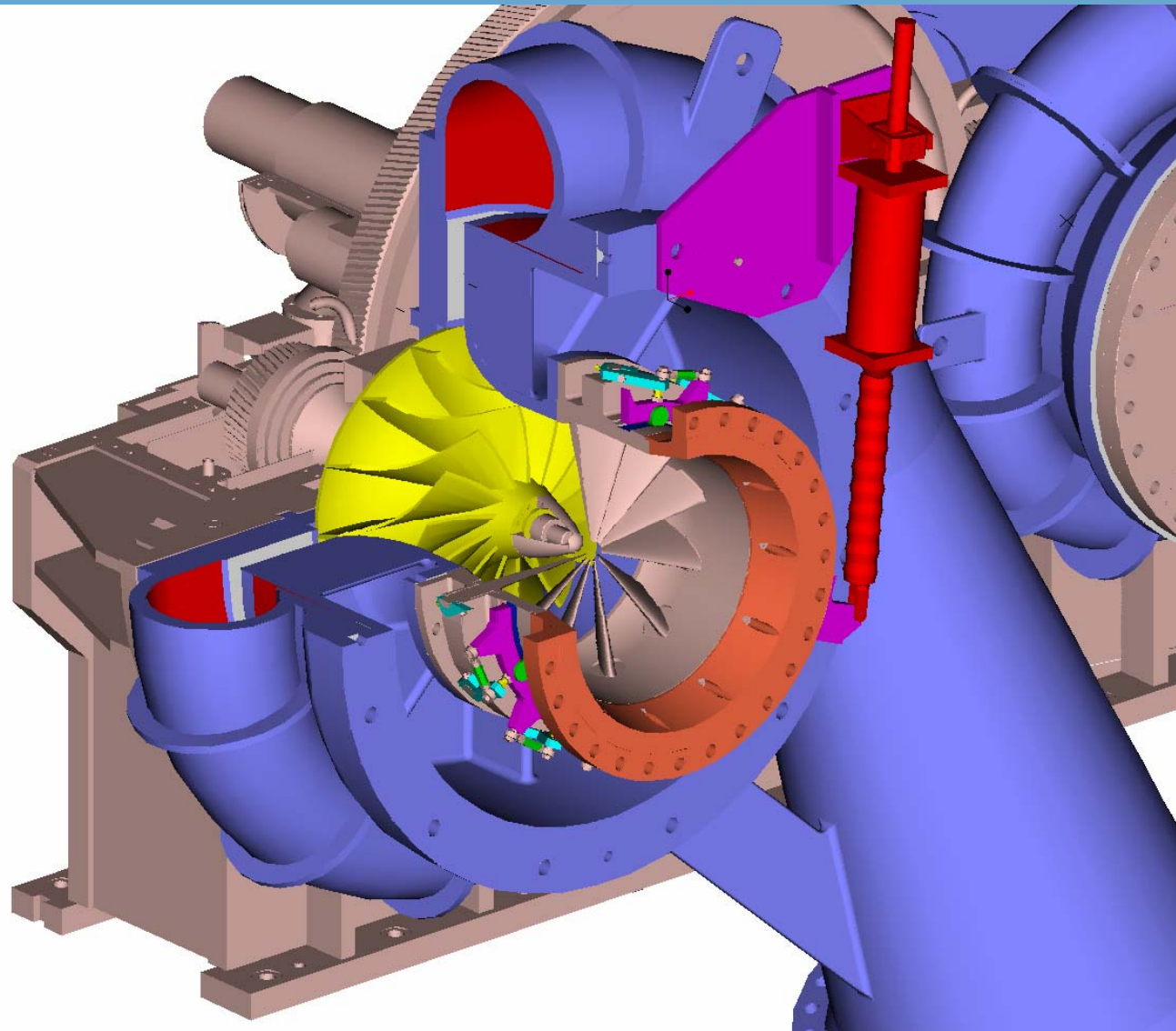

# Integrally-Geared Centrifugal

## Basic Design

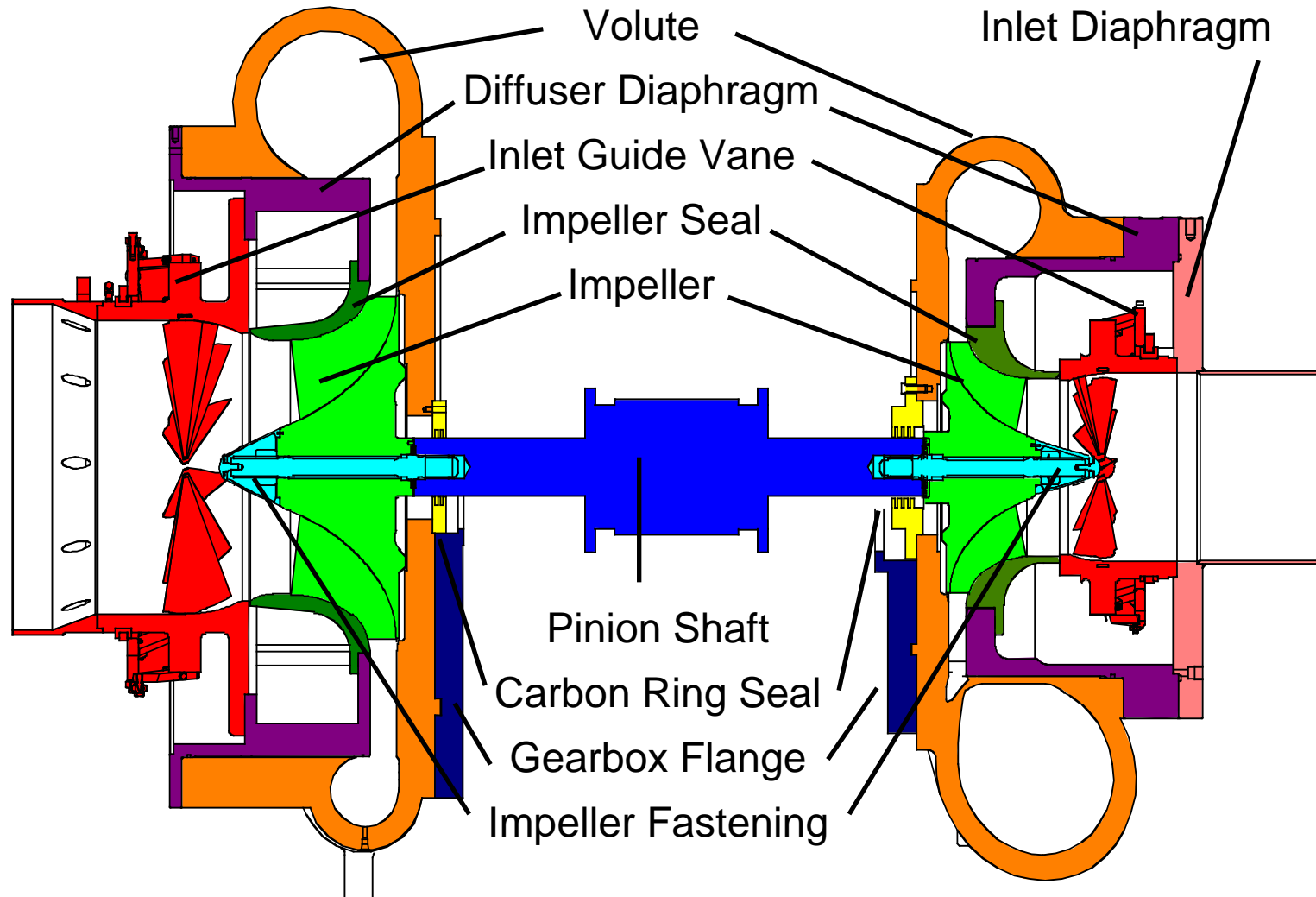

# Integrally-Geared Centrifugal

## Basic Design

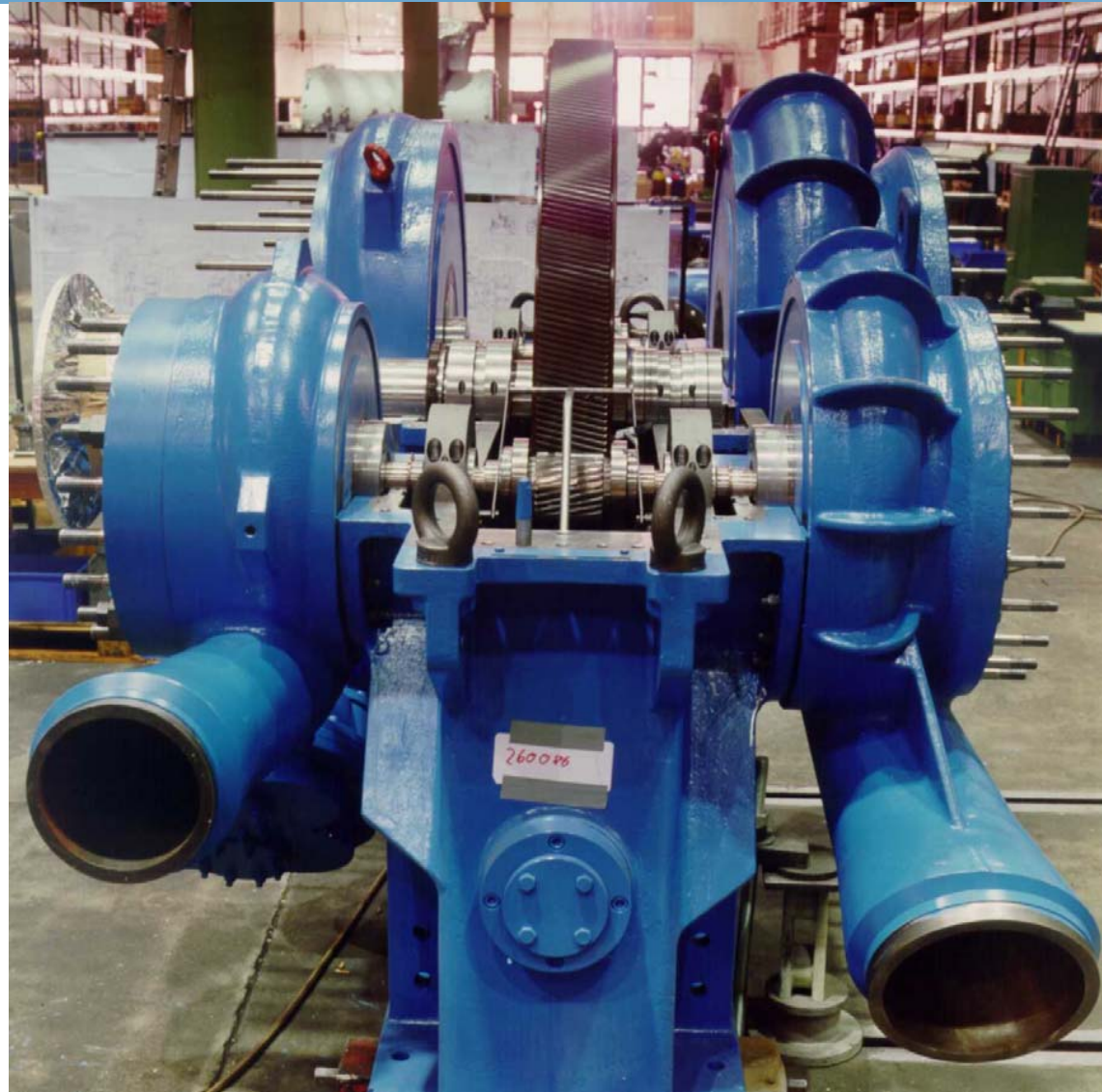



# Integrally-Geared Centrifugal

## Basic Design

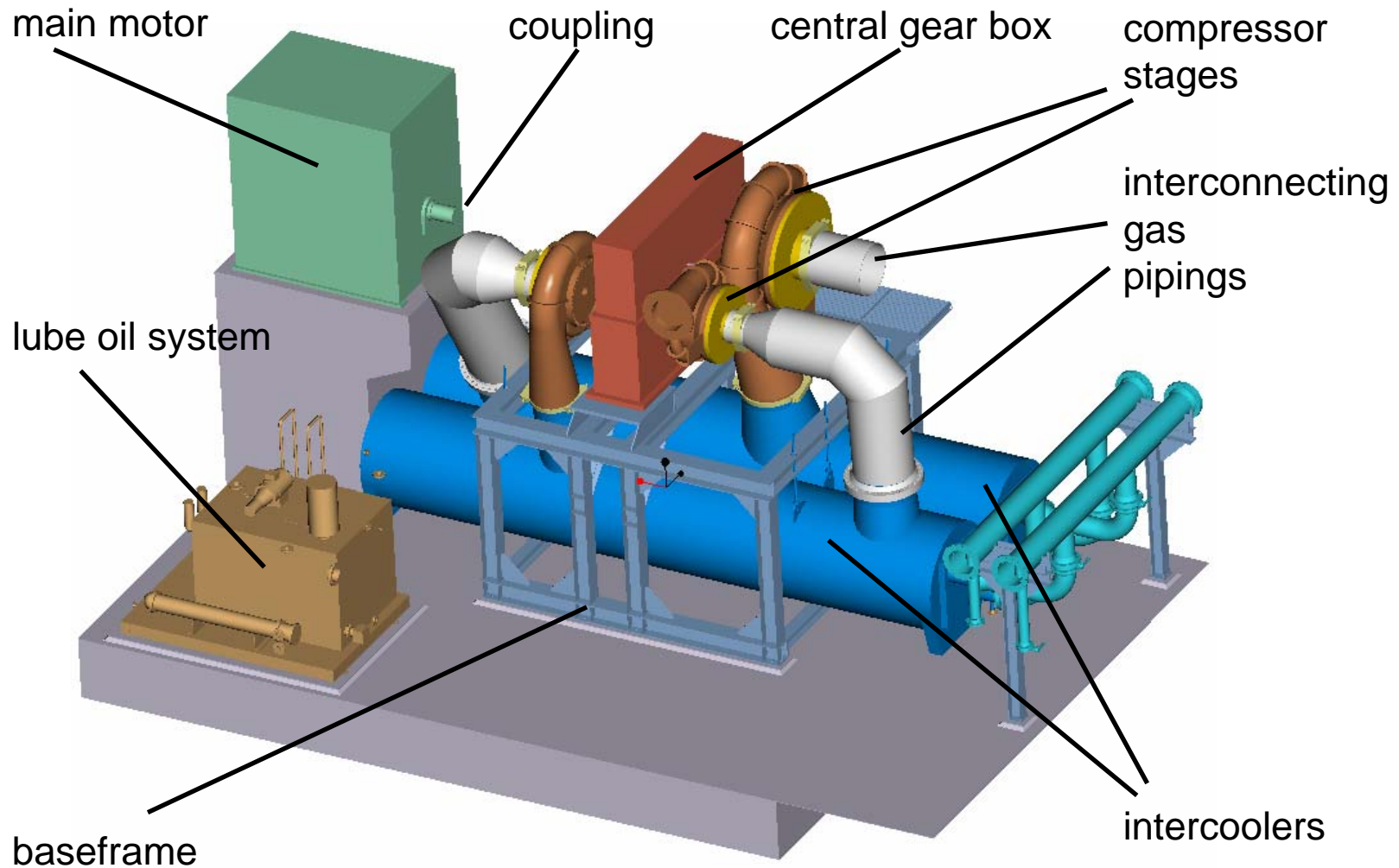

# Integrally-Geared Centrifugal

## Basic Design

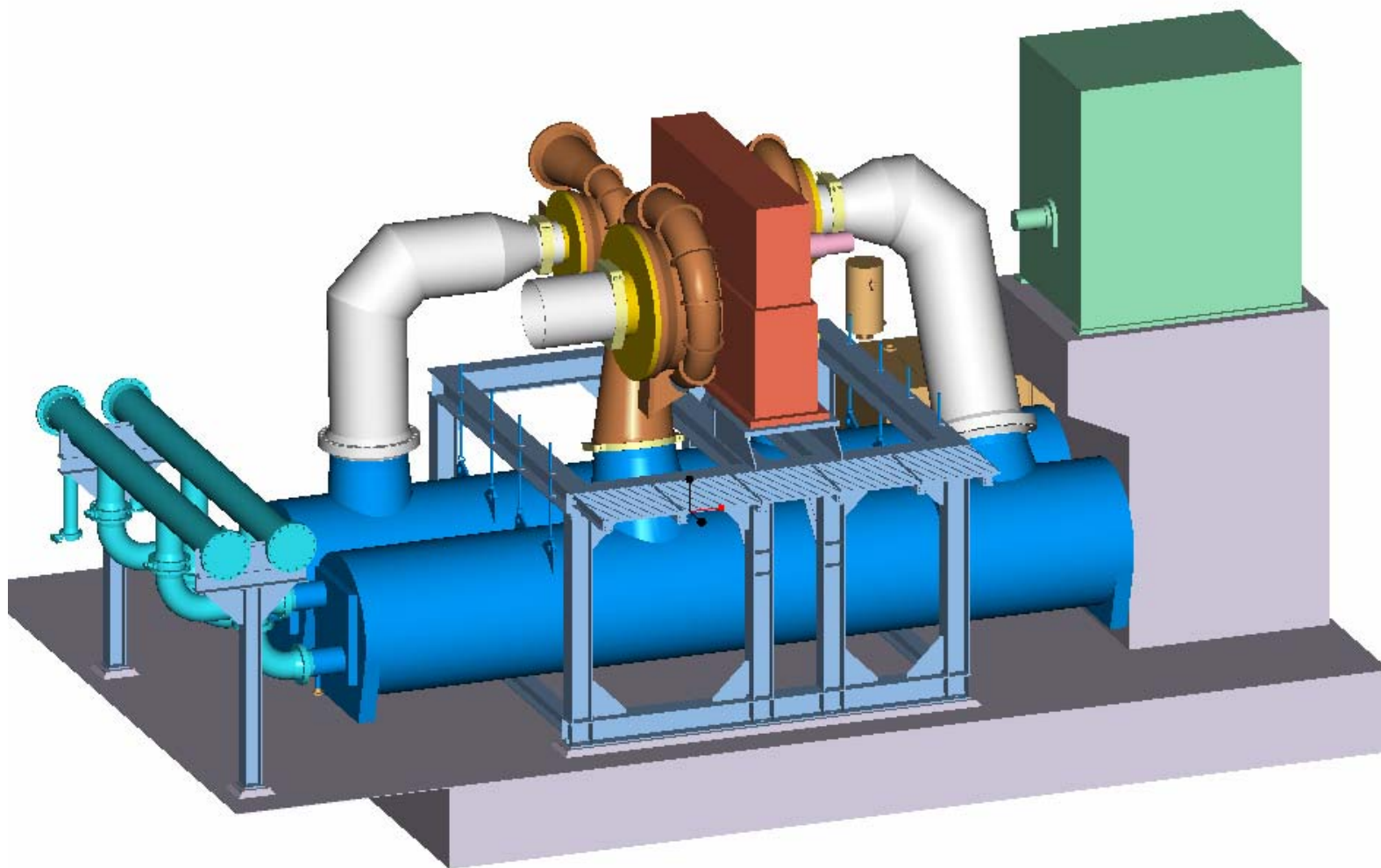

# Integrally-Geared Centrifugal Inlet Guide Vanes

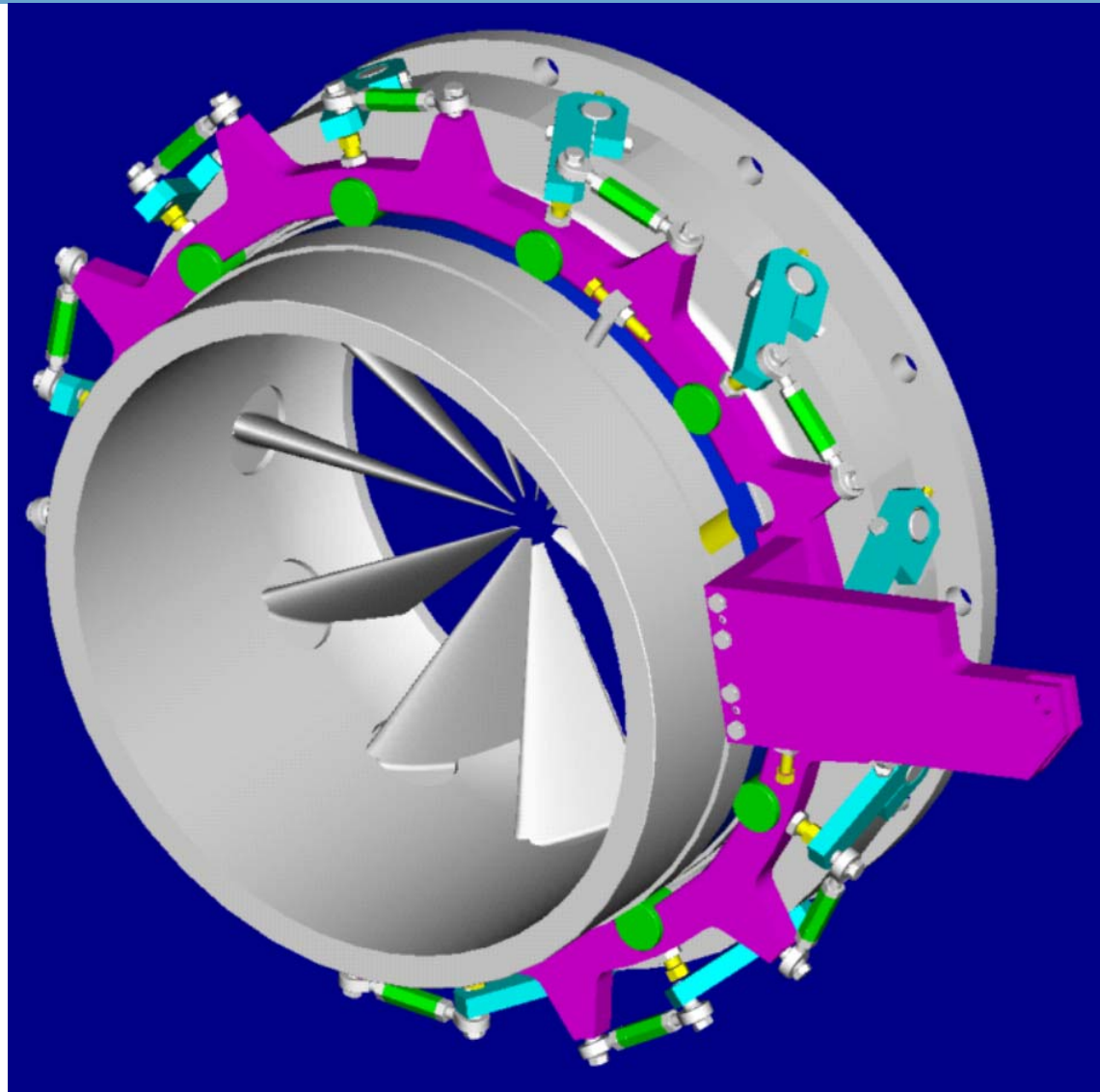

# Integrally-Geared Centrifugal Typical Shaft Seals

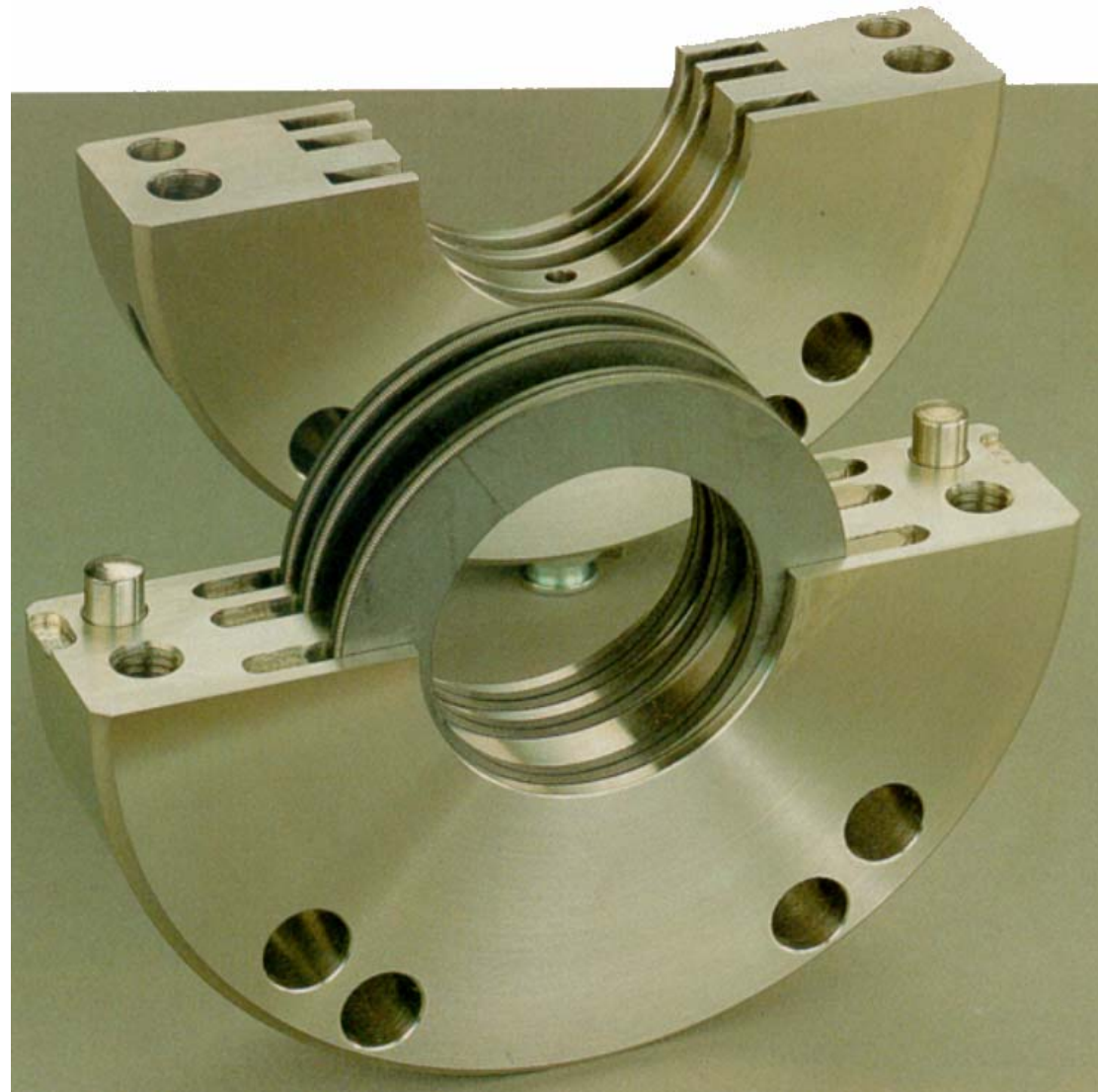

Source: Espey

# Integrally-Geared Centrifugal

## Typical Design of a Carbon Ring Seal

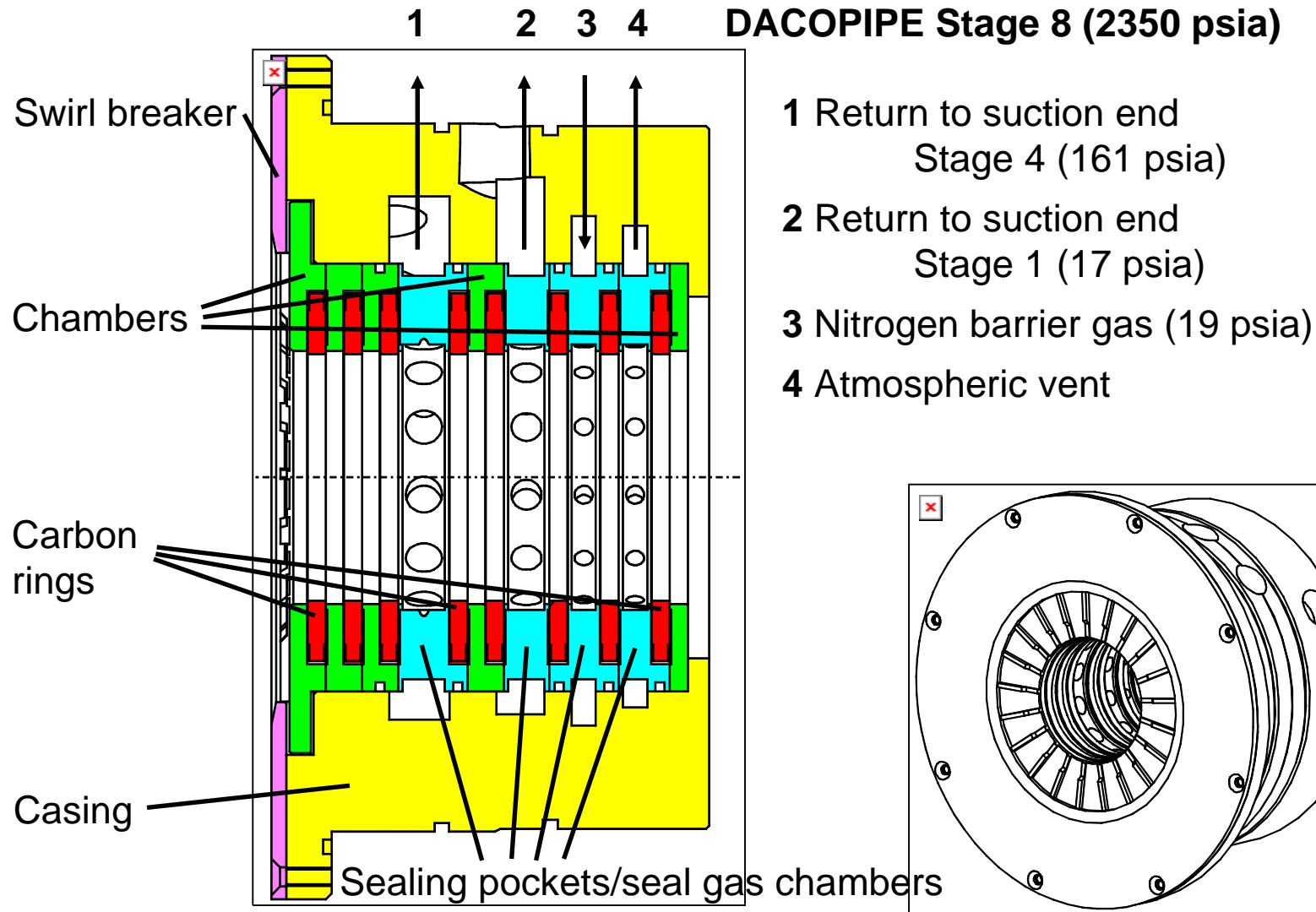

# Integrally-Geared Centrifugal Thrust Collar

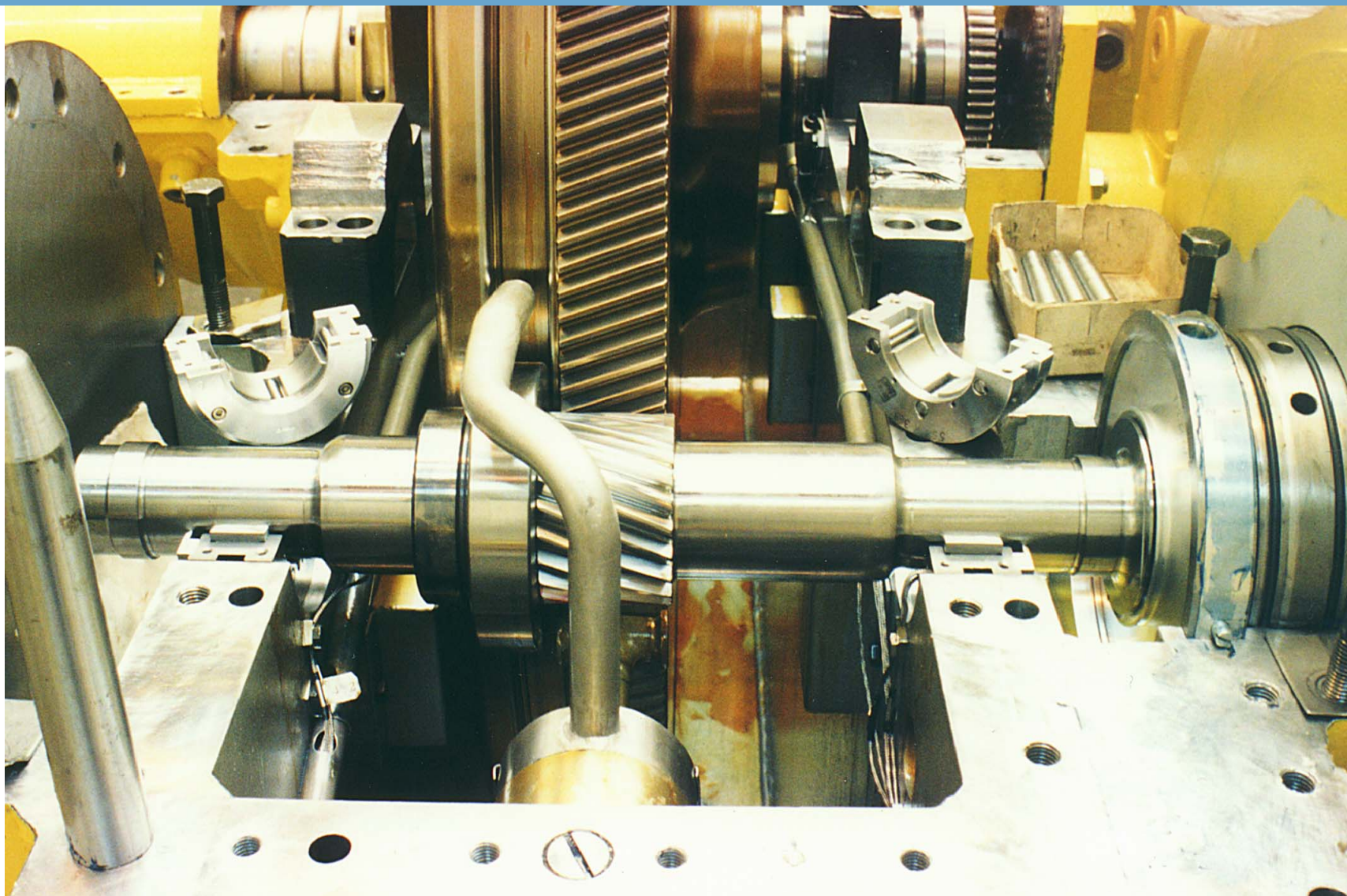

# Integrally-Geared Centrifugal Performance



## Urea Synthesis Process

- RG 40-8
- Gas Wet CO<sub>2</sub> Mix
- Flow 7,500 acfm
- Pressure 15 – 2,320 psia ( $r = 160$ )
- Power 5,700 HP



# Integrally-Geared Centrifugal

## Basic Design



### Typical 8-Stage Arrangement

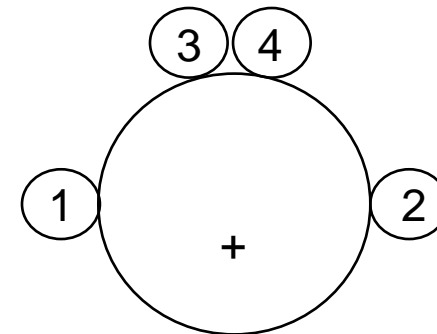
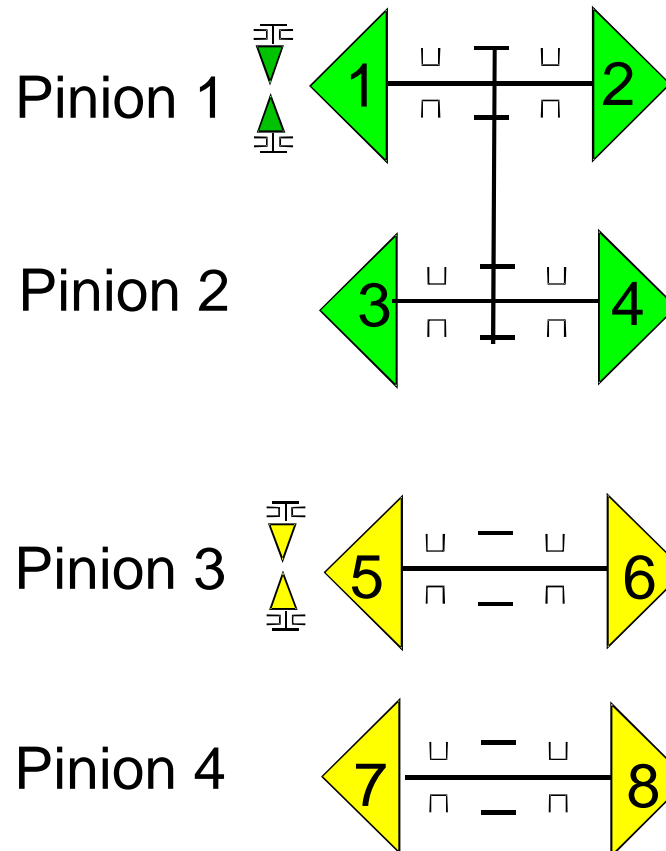



# Integrally-Geared Centrifugal Performance



## Wet CO<sub>2</sub> Compressor

- Model  
RG053-10
- Inlet Volume  
13,800 acfm
- Pressure  
15-2,900 psia  
( $r=200$ )
- Speed  
11,000-  
50,000 rpm
- Power  
6,200 HP

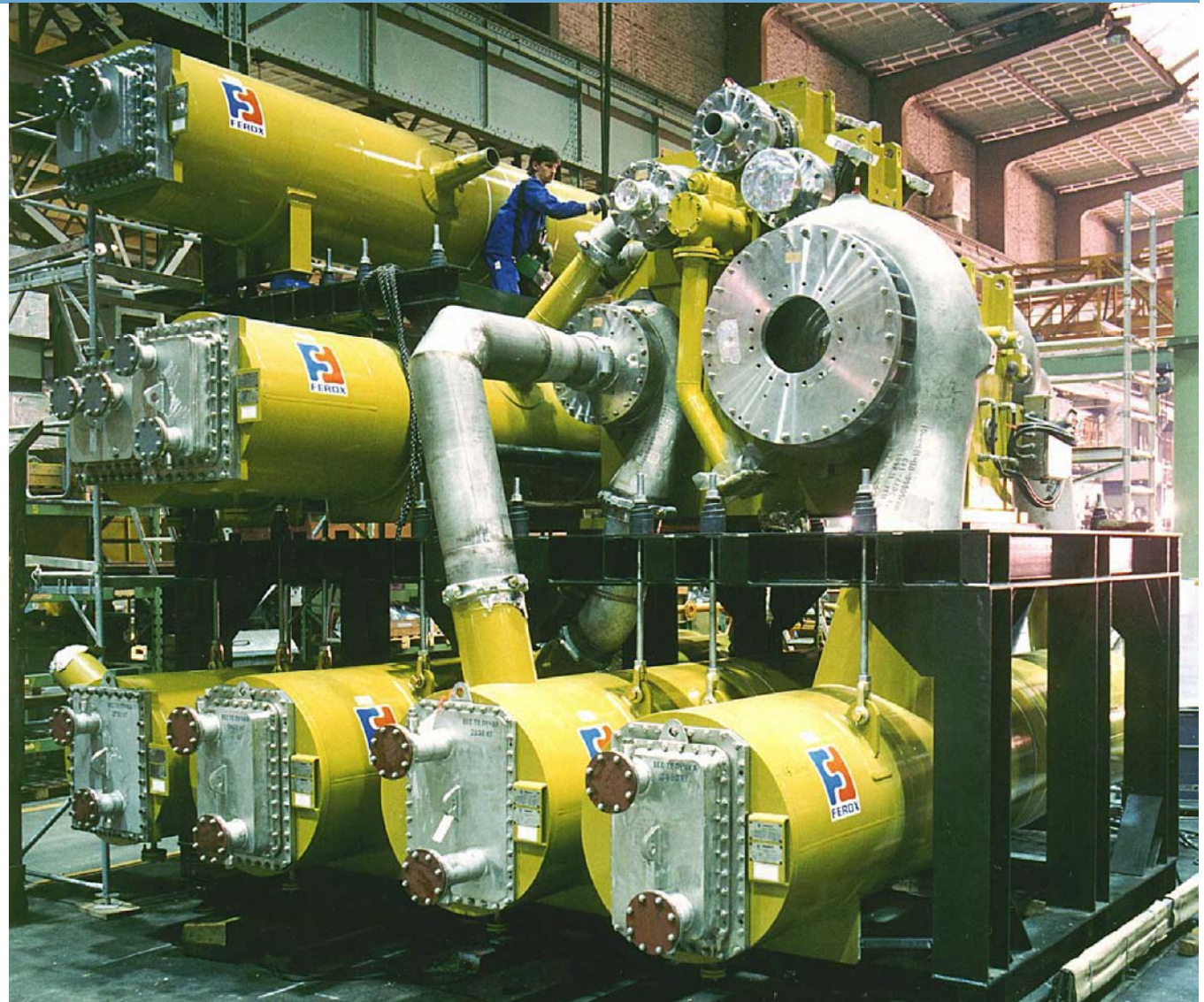

# CO<sub>2</sub> High Pressure Geartype Compressors

First steps in the early 90s



- **World's first double bull-gear multishaft geartype compressor patented**
- **1st 10 stage compressor for wet CO<sub>2</sub> service designed, fabricated and in operation for AZOT Nowomoskowsk**

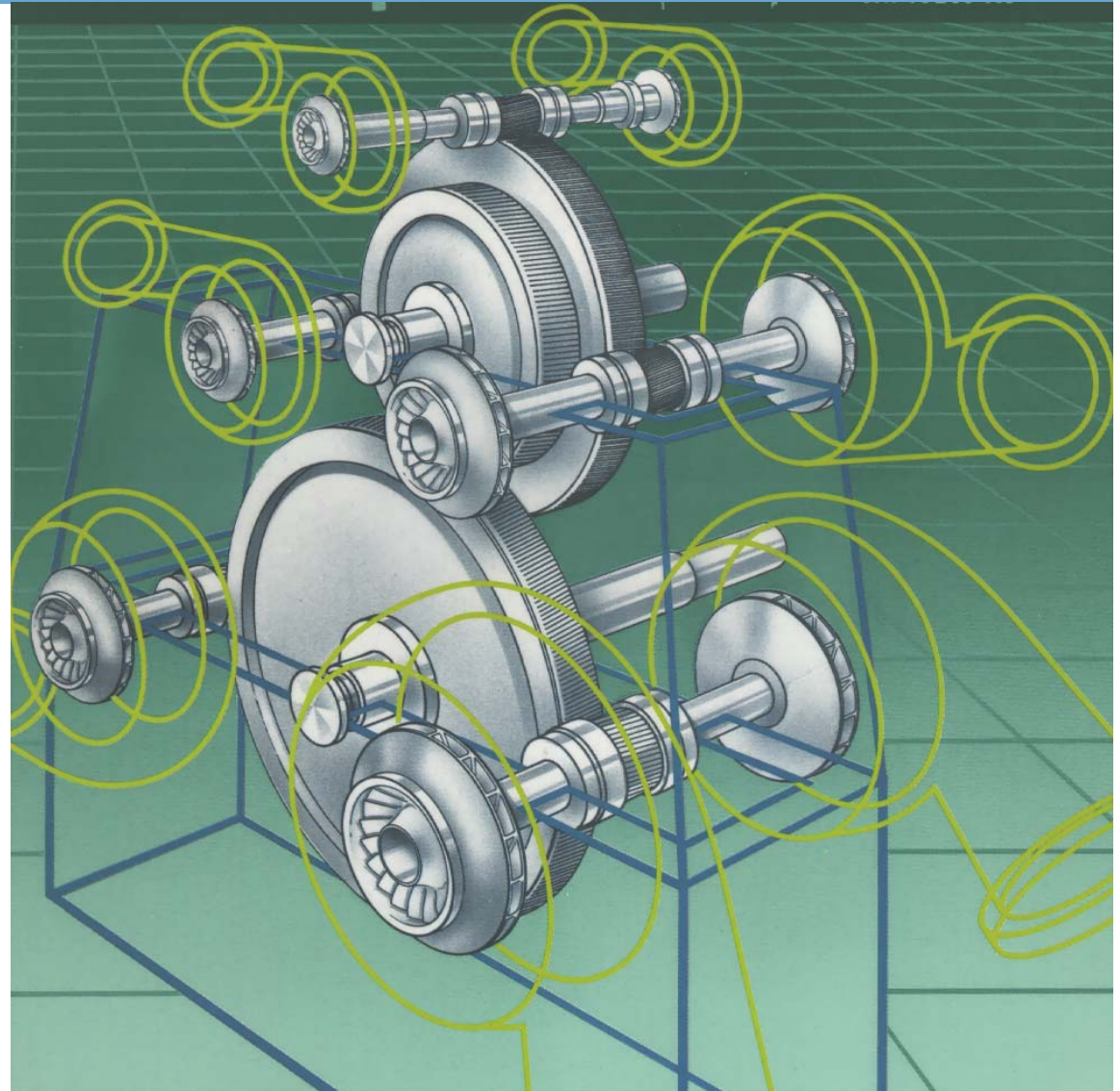

# Integrally-Geared Centrifugal Typical Installation



# Case Study – High Pressure CO<sub>2</sub> Compressor



# Case Study – High Pressure CO<sub>2</sub> Compressor

Compressor

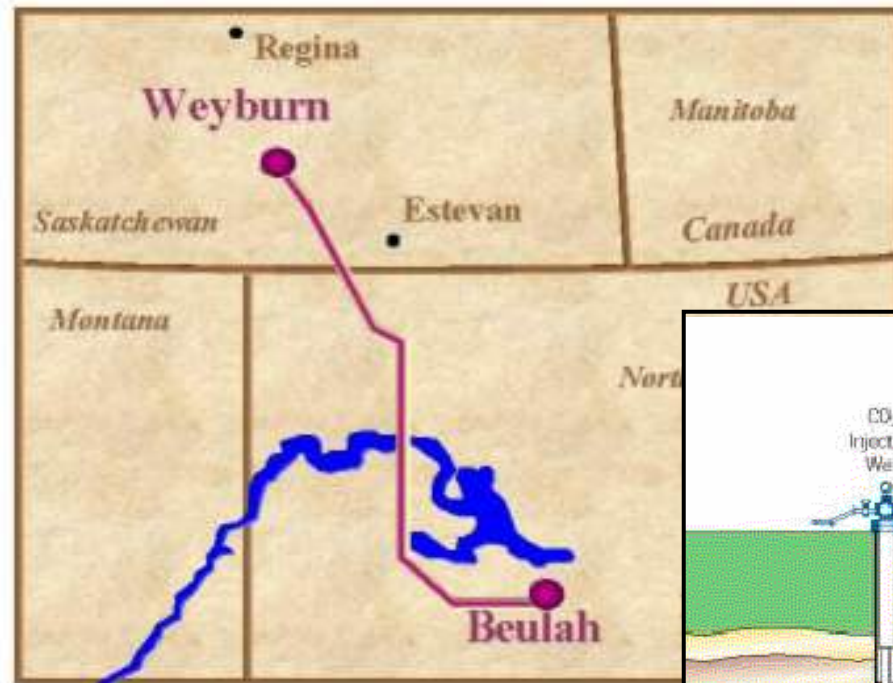

Enhanced Oil Recovery

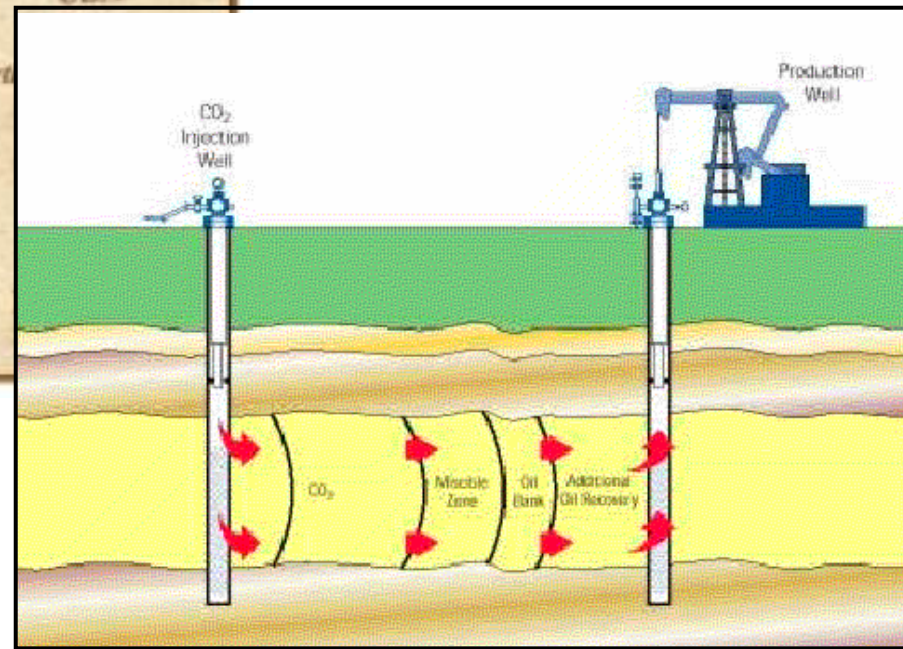

# Integrally-Geared Centrifugal 8 Stages



## CO<sub>2</sub> Compressor

- Model  
RG080-8
- Inlet Volume  
34,242 acfm
- Pressure  
17-2,717 psia  
( $r = 160$ )
- Speed  
7400-26,400  
rpm
- Power  
15,150 HP

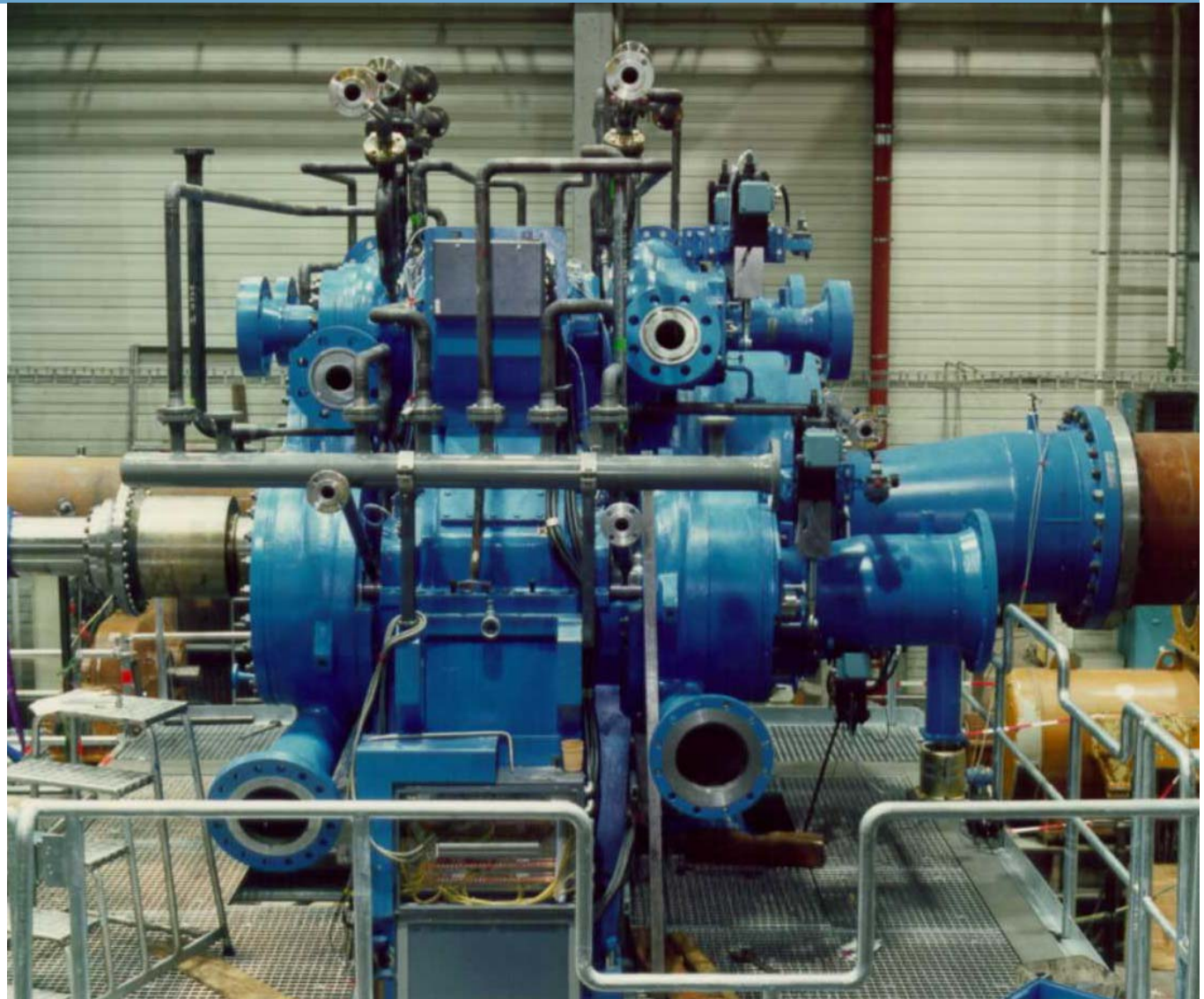

# Integrally-Geared Centrifugal



Integrally Geared Centrifugal Impellers:  
Stages 1 through 8



# Integrally-Geared Centrifugal 8 Stages

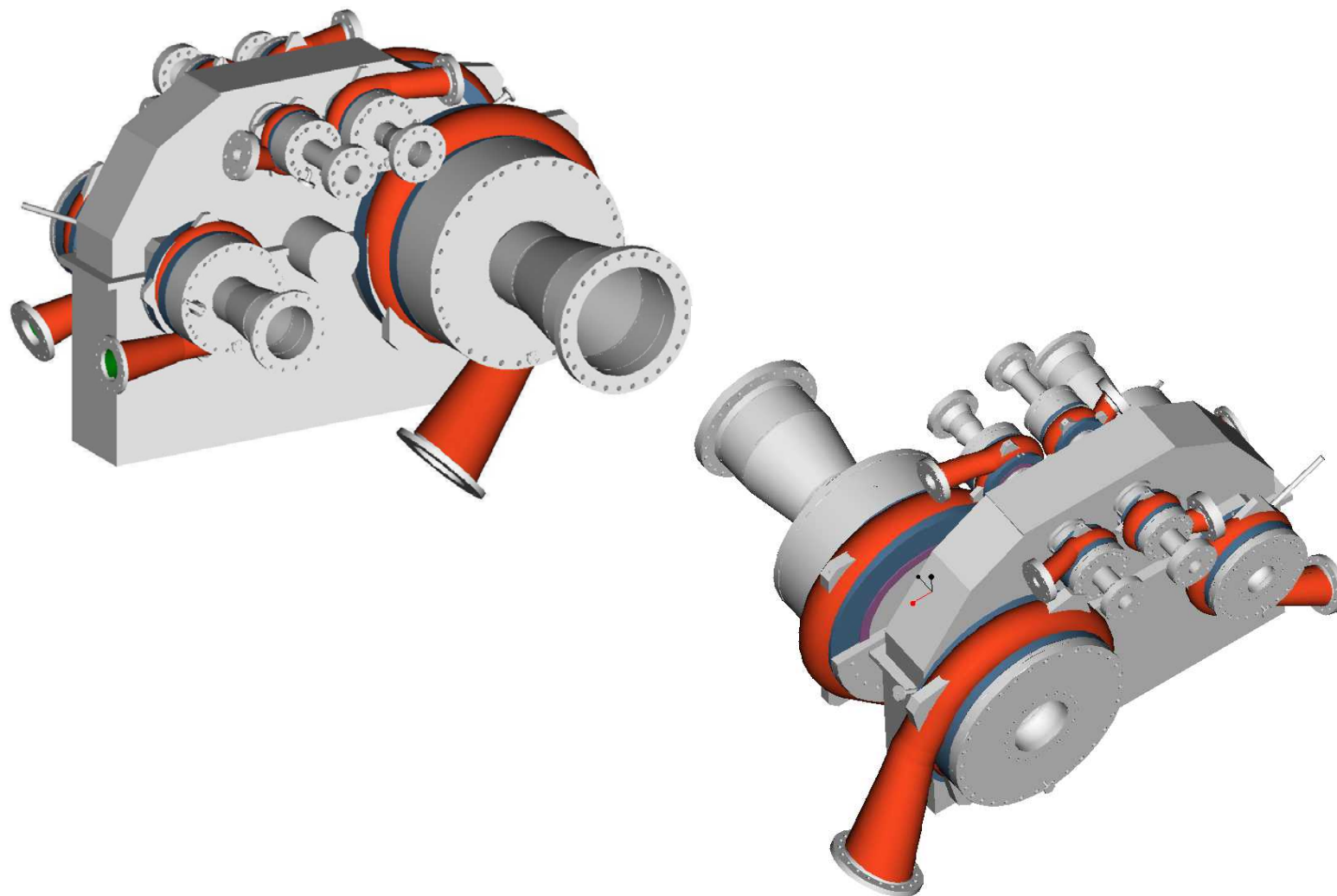



# Integrally-Geared Centrifugal Compressor

DGC - Beulah, North Dakota

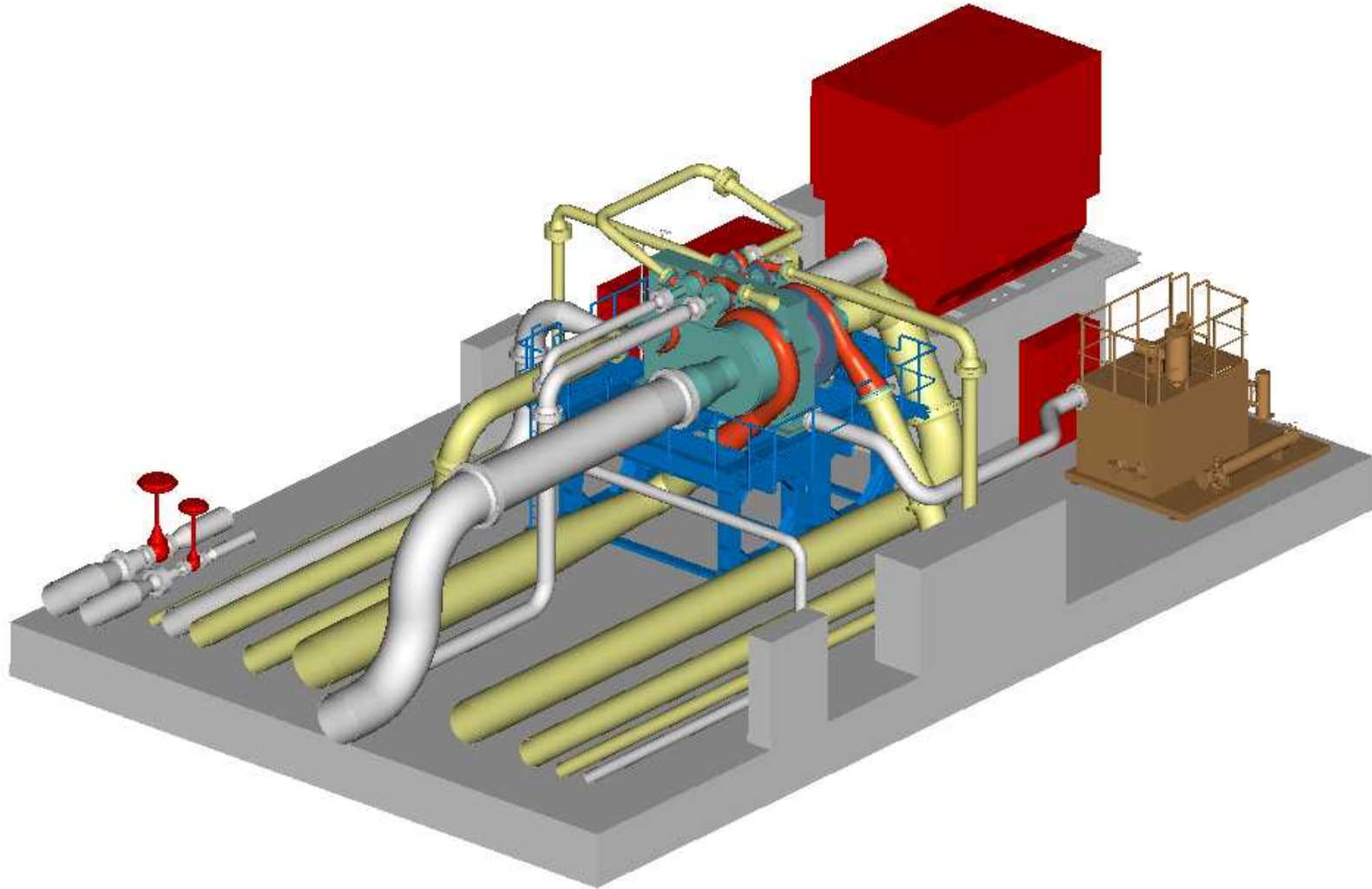

# Integrally-Geared Centrifugal Compressor

DGC - Beulah, North Dakota



# CO<sub>2</sub> High Pressure Geartype Compressors

## Thermodynamic Design

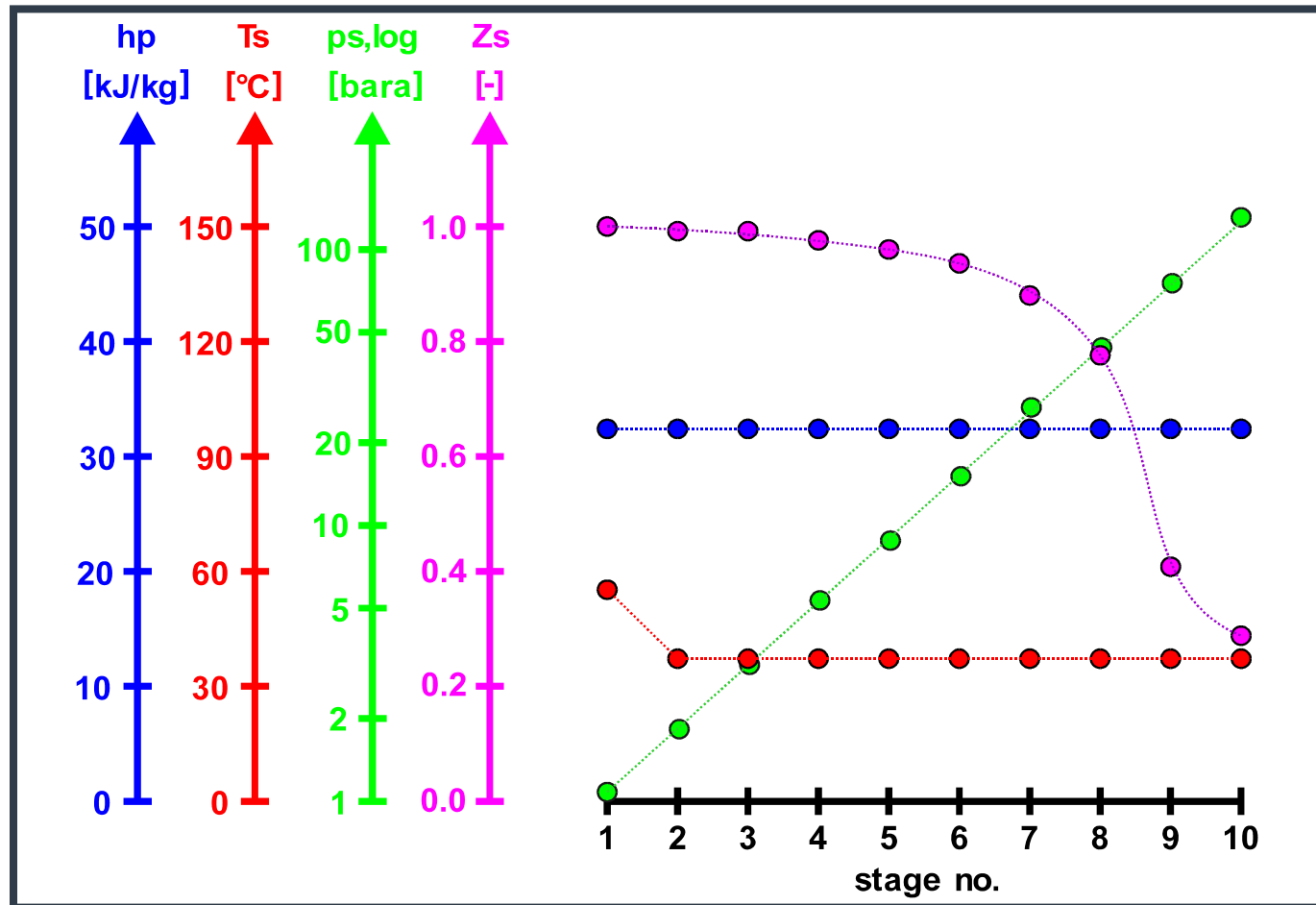

# CO<sub>2</sub> High Pressure Compressors

## Sensitivity of Real Gas Factors for Various Gases

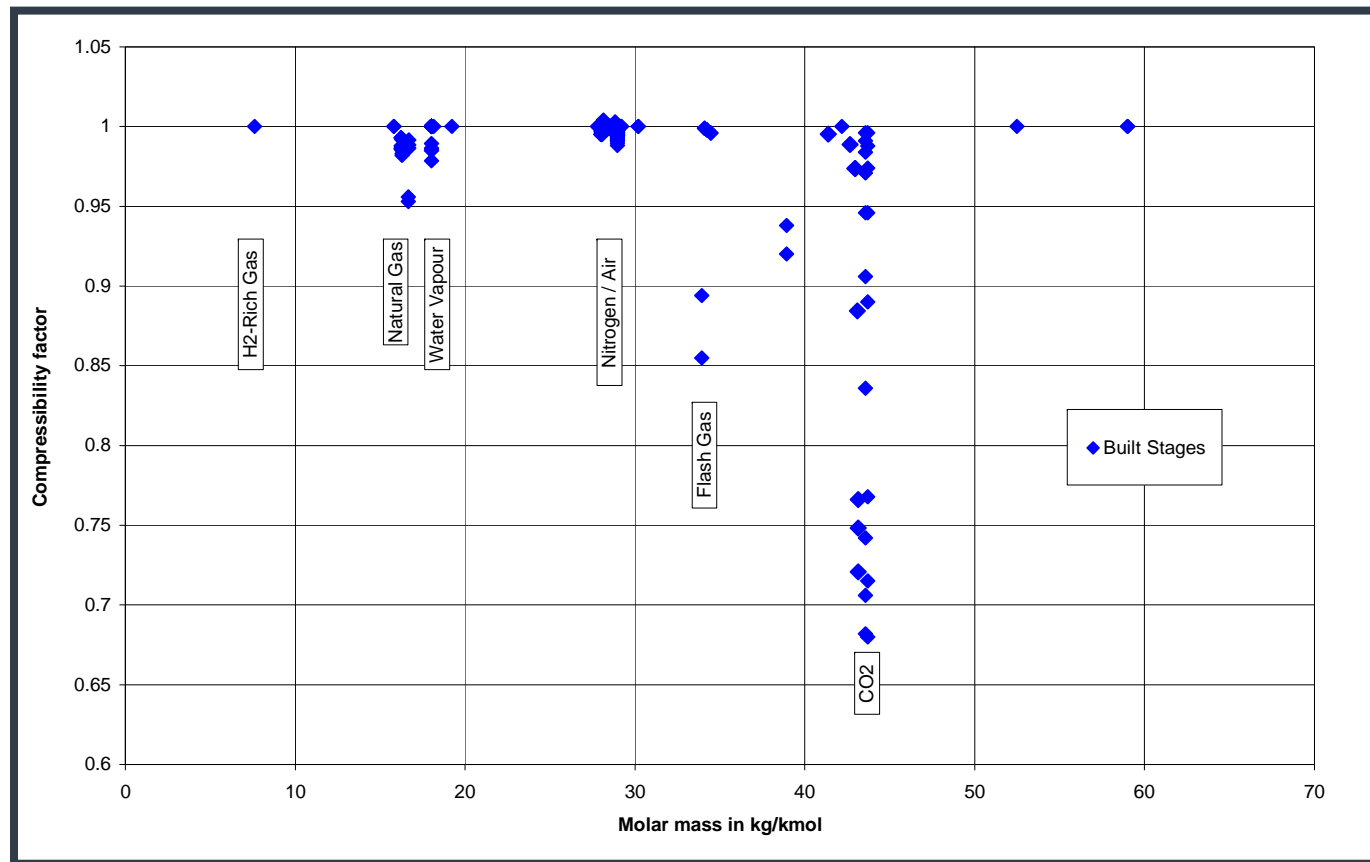

# Integrally-Geared Centrifugal Compressor

## Compression Path in Temperature-Entropie-Diagram

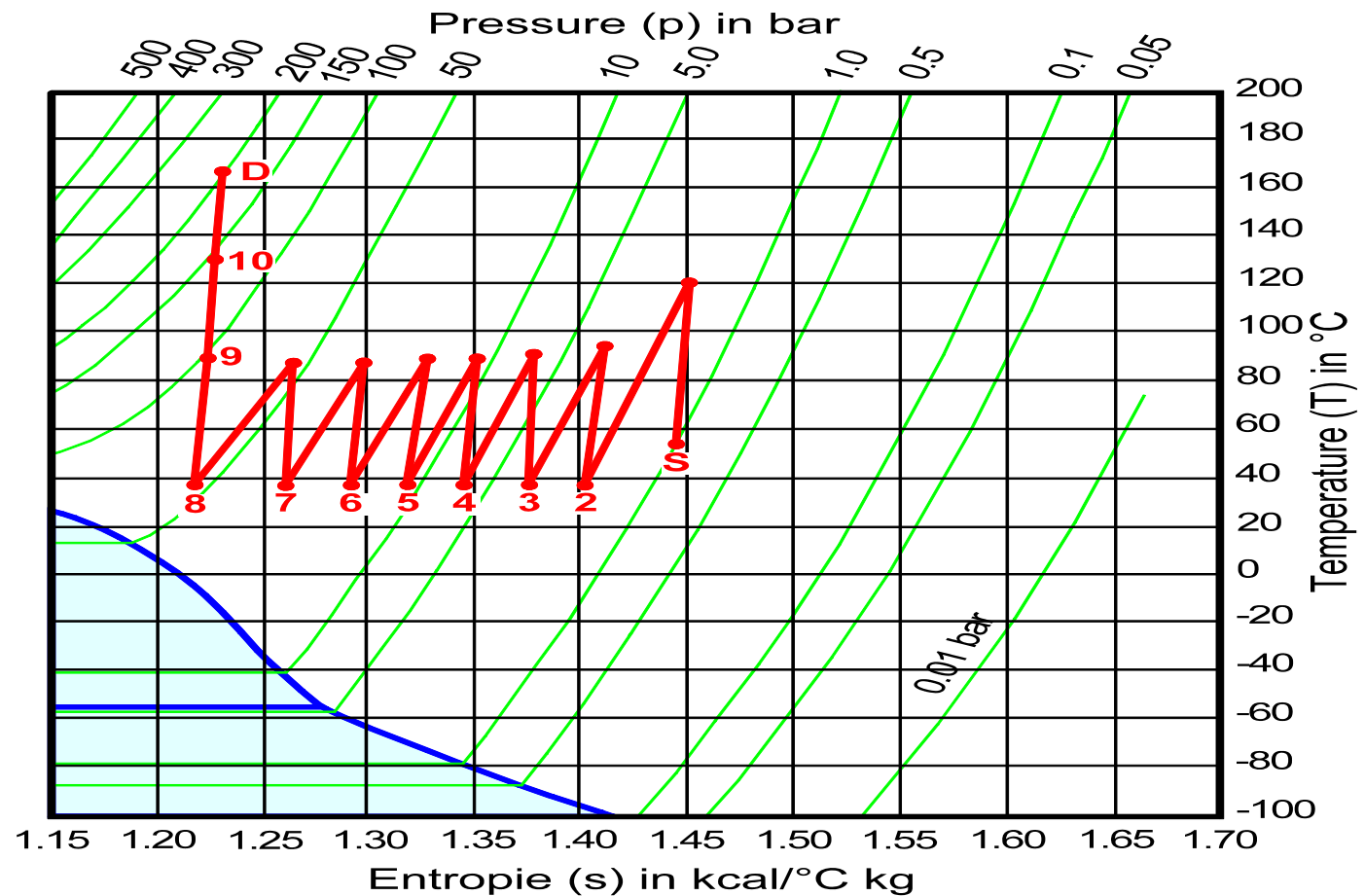

# CO<sub>2</sub> High Pressure Compressors

## Thermodynamic Design

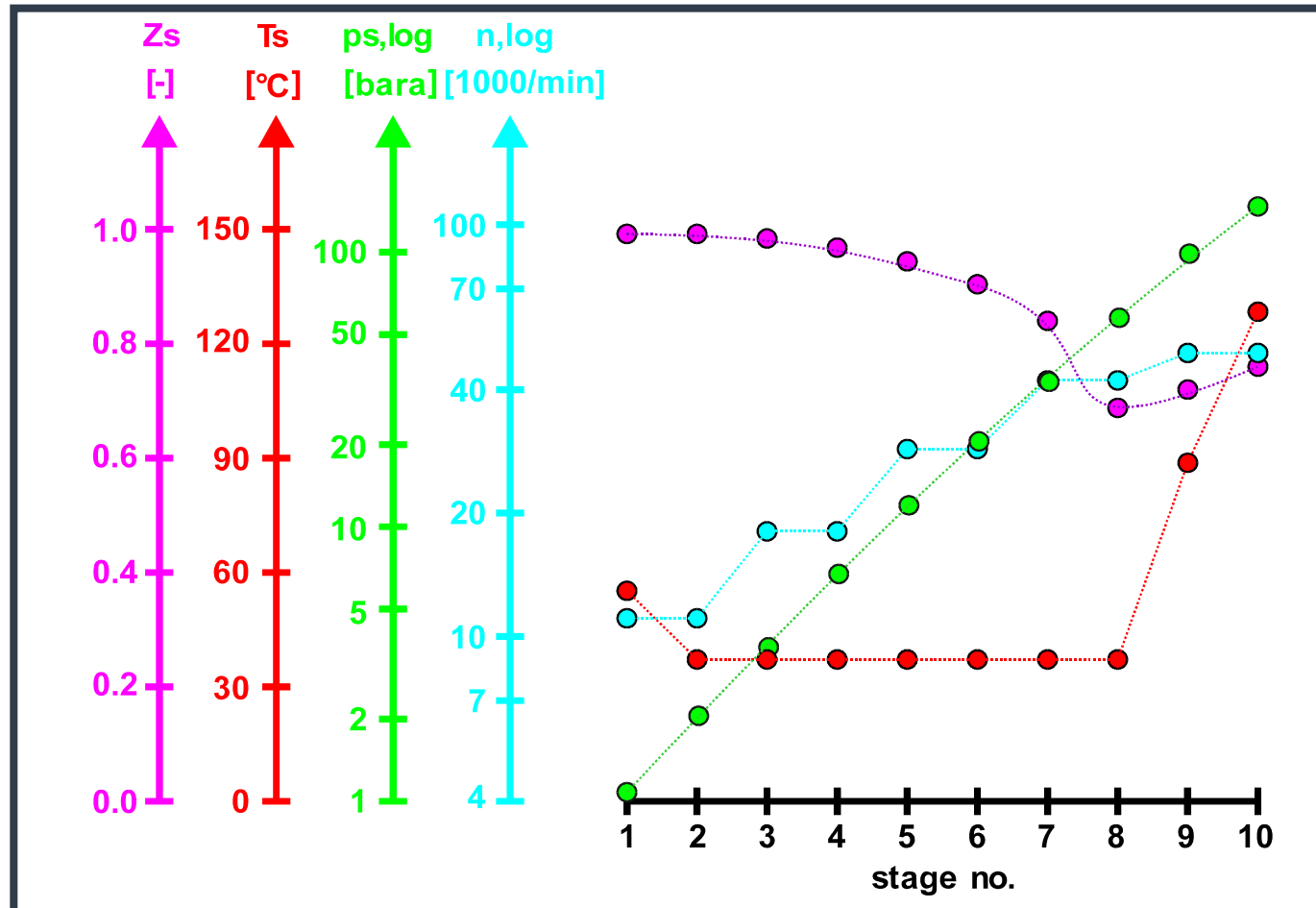

# Integrally-Geared Centrifugal 8 Stages

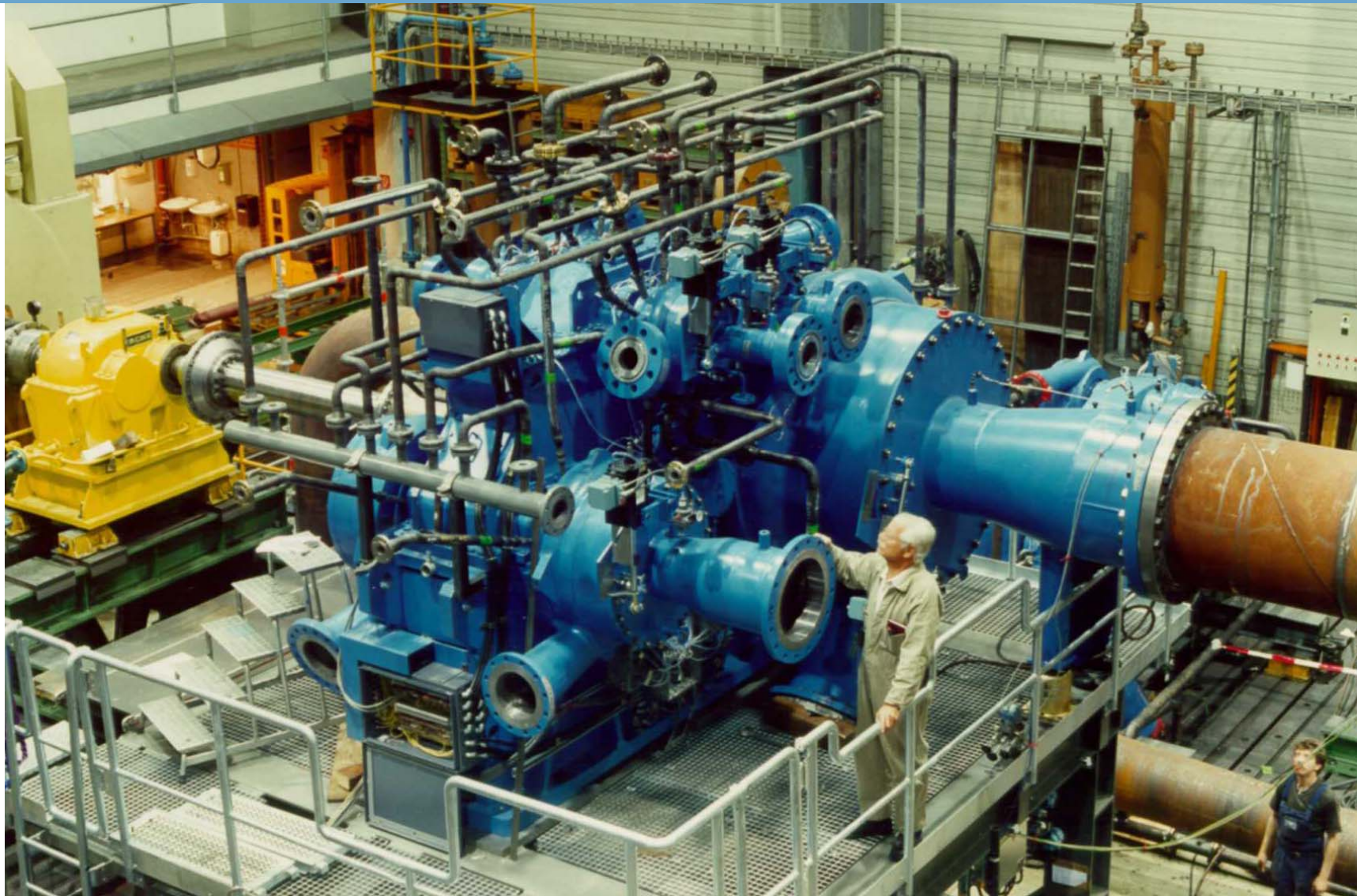

# EnCana

## Weyburn Oilfield Receiving Terminal





# Integrally-Geared Centrifugals



The first two compressors in North Dakota have been in operation since 1997; the third machine was installed in 2006.

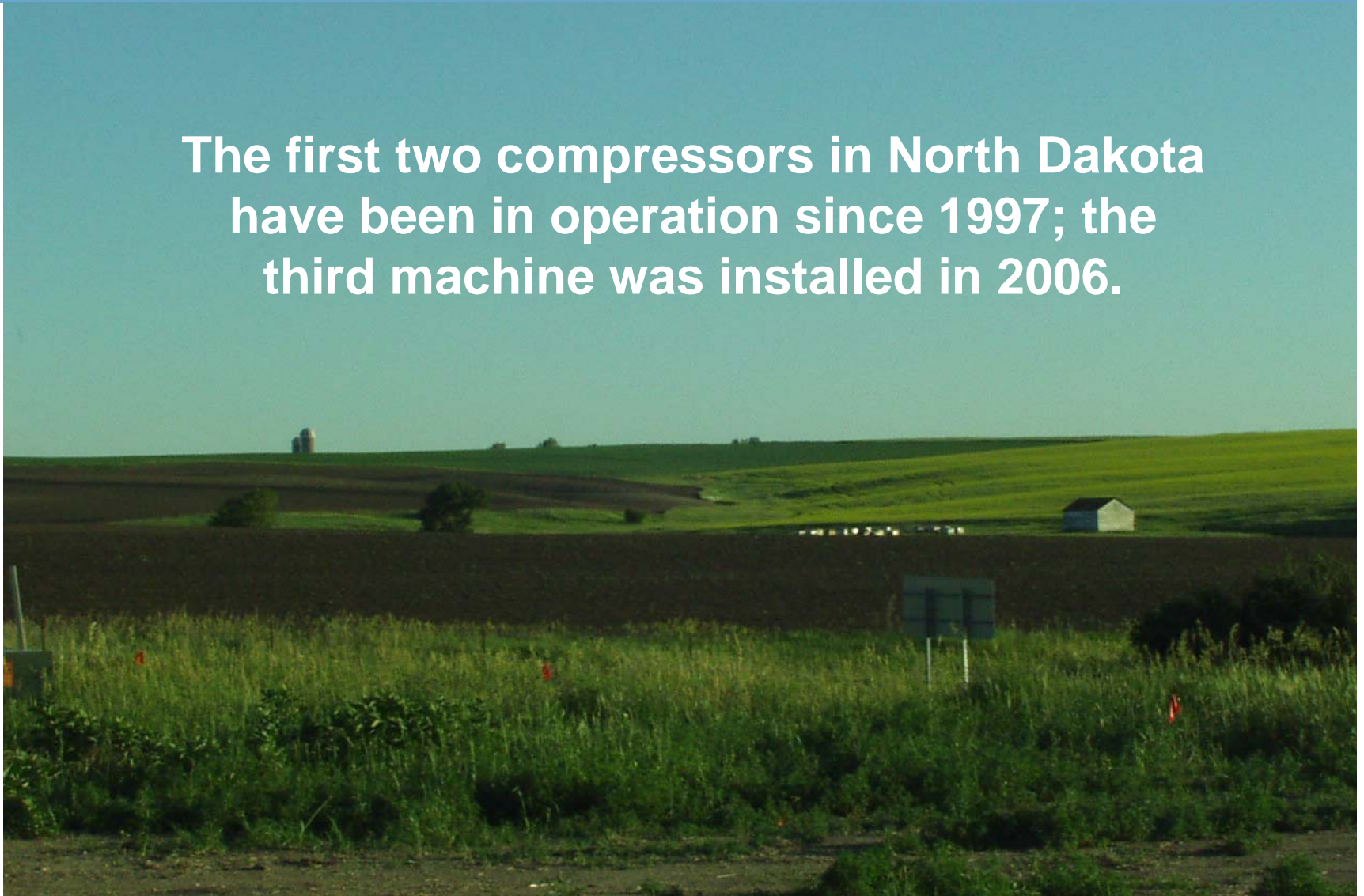



# Thank you for your attention

Engineering the Future –  
Since 1758.

Session 3.3



**CO<sub>2</sub> Compression  
Capabilities  
Minotti**

# CO2 compression capabilities

Marco Minotti



GE imagination at work

Enabling technologies

l a n d • o f f s h o r e • s u b s e a



# Agenda

- CO<sub>2</sub> compression
- Experience

# CO<sub>2</sub> Re-injection



# Equation of State

- GE has used the BWRS EOS for the last 30 years: up to 300 bar on regular basis and up to 540 bar with CO<sub>2</sub> + HC gas mixture in specific cases .... also in the supercritical region

$$P = RTD + (BoRT - Ao - Co/T^2 + Do/T^3 - + Eo/T^4)D^2 + (bRT - a - d/T)D^3 + \alpha(a + d/T)D^6 + c/T^2(1 + \gamma D^2)D^3 e^{-\gamma D^2}$$

BWRS Equation

BWRS above 480 bar requires careful verification of literature data and is not suitable for liquid-vapour equilibrium calculations

- Many existing CO<sub>2</sub> EOS are optimized for pure CO<sub>2</sub> but not for mixtures
- To allow for regions not adequately covered by current EOS, GE is introducing a new thermodynamic model to improve predictability

# Product Lines for CO<sub>2</sub> Compression

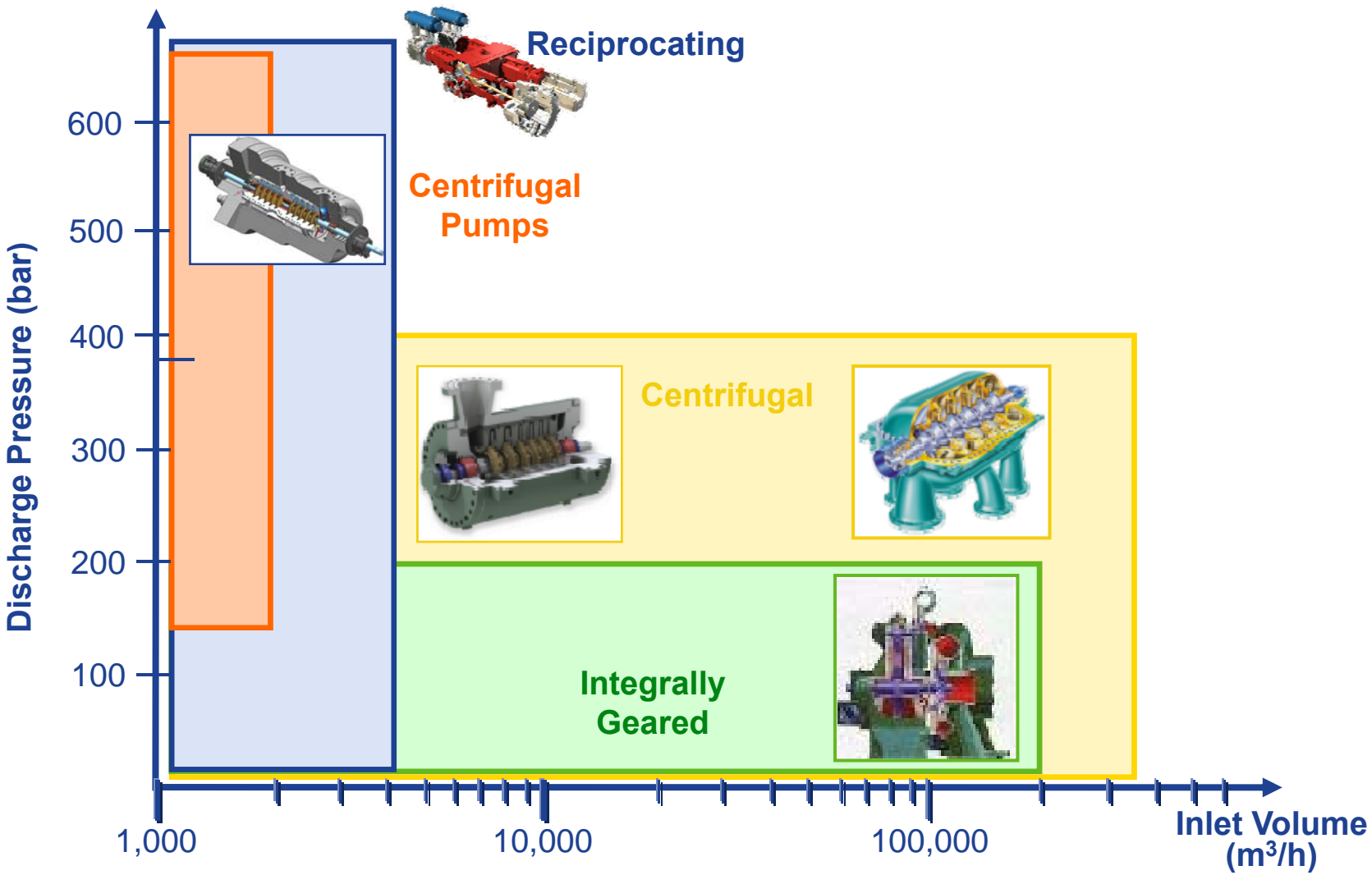



# Compression + Pumping Optimization

Compression from 1.5 bar up to approx. 220 bar

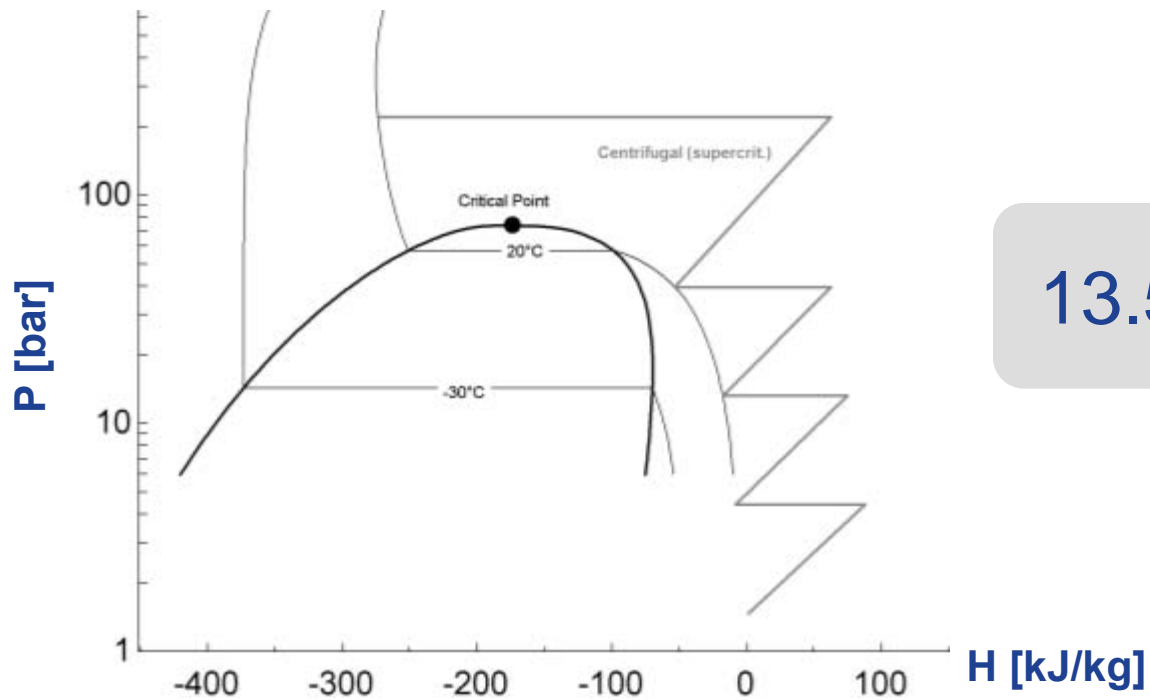

# Compression + Pumping Optimization

Compression from 1.5 bar up to approx. 220 bar

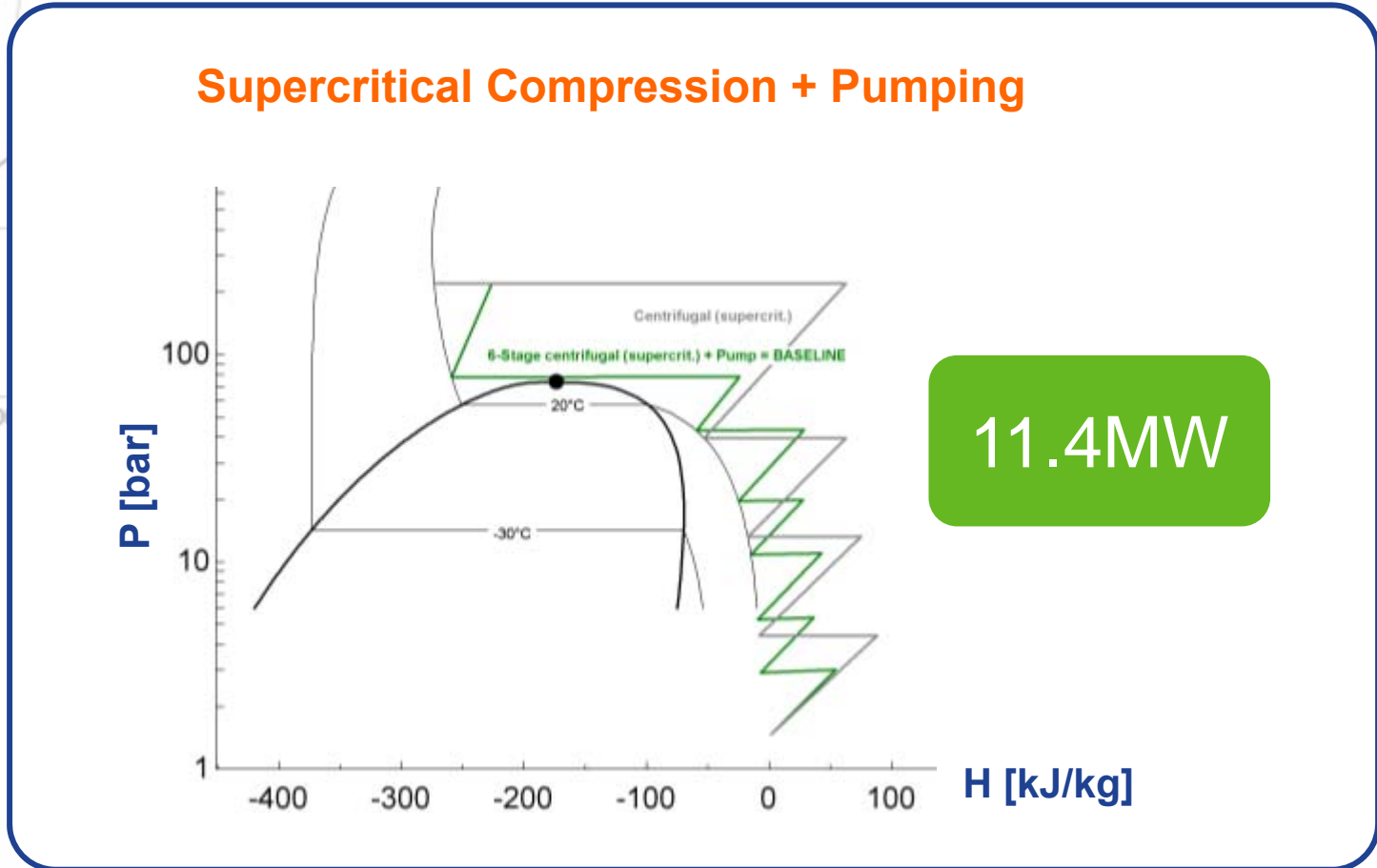

# Compression + Pumping Optimization

Compression from 1.5 bar up to approx. 220 bar    Supercritical Compression + Pumping

## Subcritical Compression + Pumping

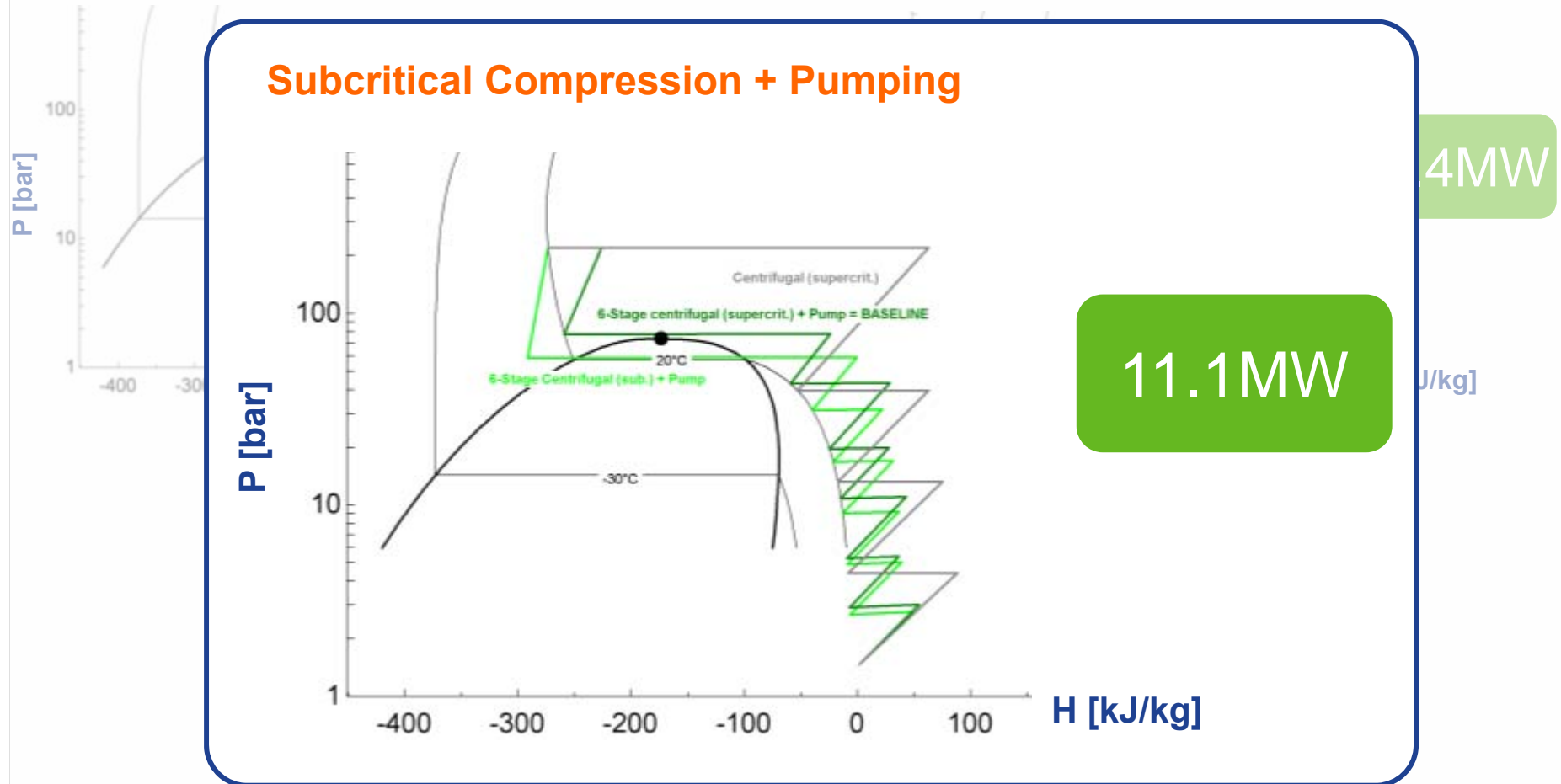

# Compression + Pumping Optimization

Compression from 1.5 bar up to approx. 220 bar    Supercritical Compression + Pumping

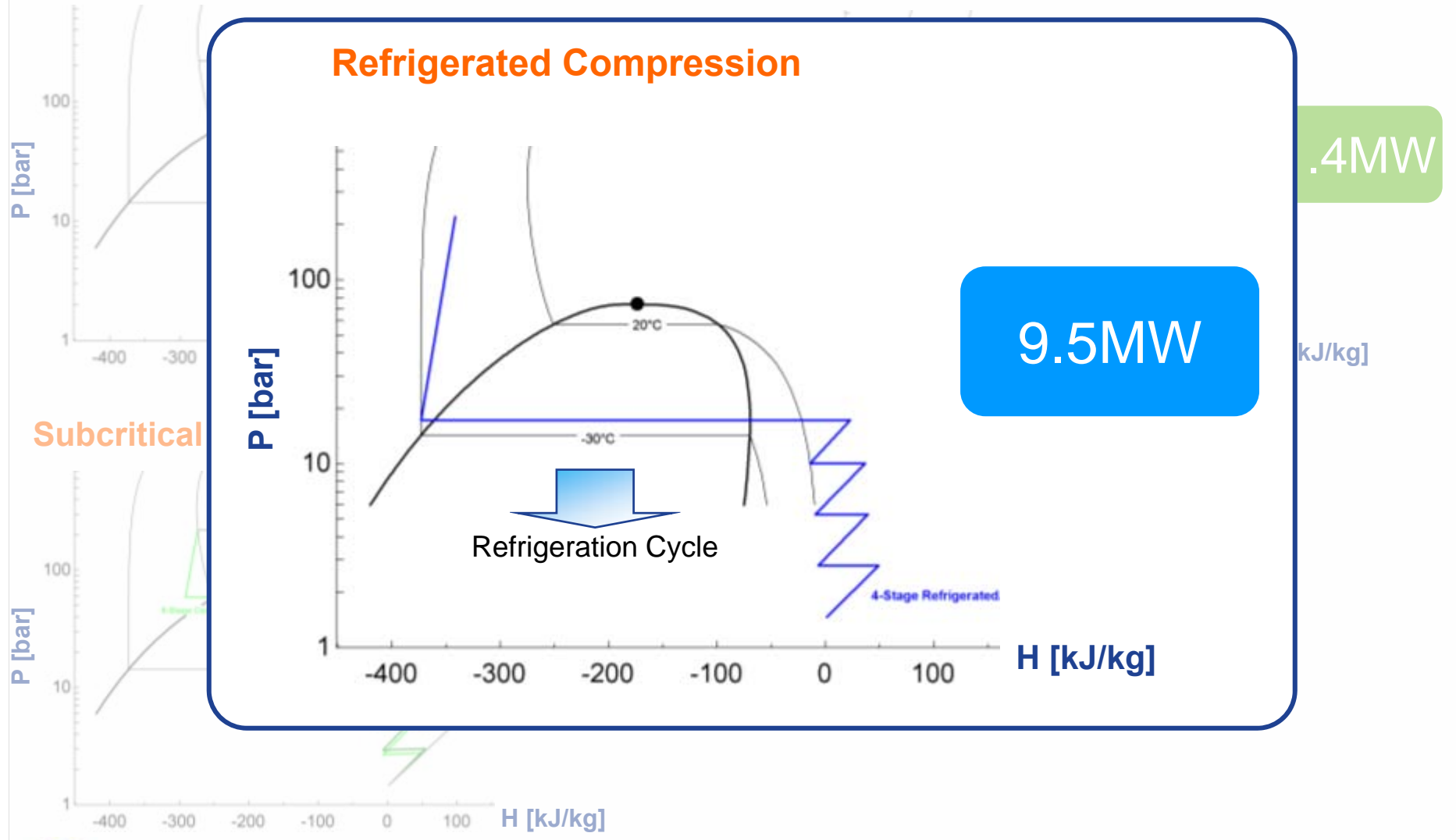

Subcritical

9.5MW

.4MW

kJ/kg

# Compression + Pumping Optimization

Compression from 1.5 bar up to approx. 220 bar    Supercritical Compression + Pumping

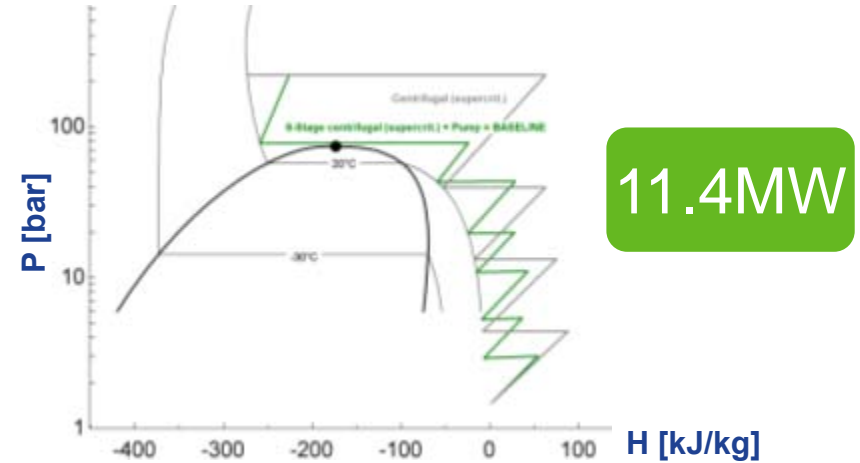
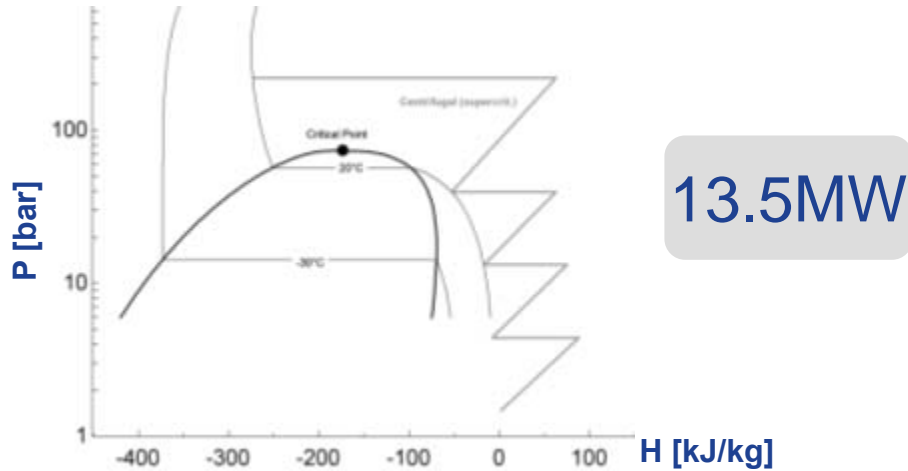

Subcritical Compression + Pumping

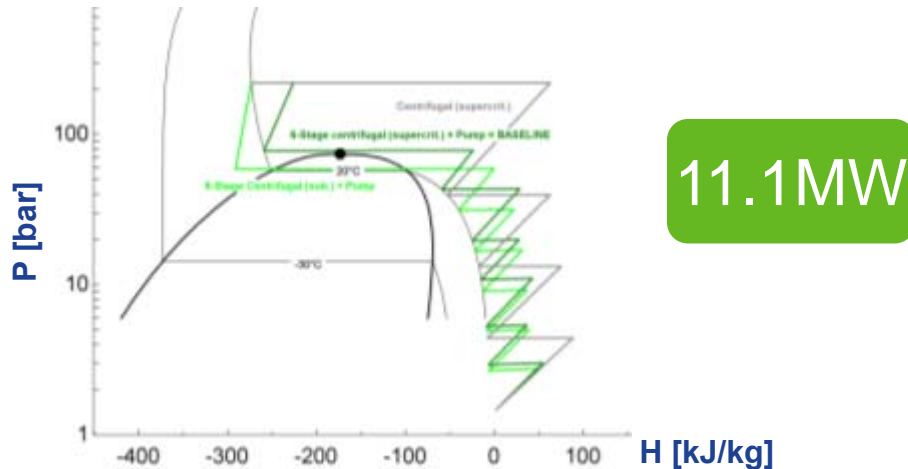

Refrigerated Compression

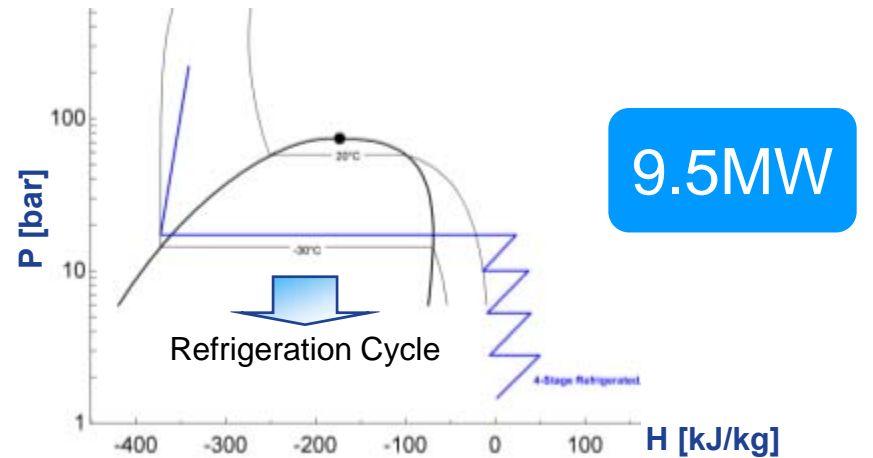

# CO<sub>2</sub> Reciprocating Compressor Experience

- Many years of experience ... started with fertilizers plants
- 180+ machines in operation processing CO<sub>2</sub> or gases containing CO<sub>2</sub>, H<sub>2</sub> and H<sub>2</sub>S
- Up to 750 bara disch. pressure ... 19,000 Nm<sup>3</sup>/h max requested capacity
- Most recent major experience CO<sub>2</sub>+H<sub>2</sub>S reinjection ... 55,000 Nm<sup>3</sup>/h @ 486 bara max. discharge pressure
- From small to large compressor sizes (HG frame)

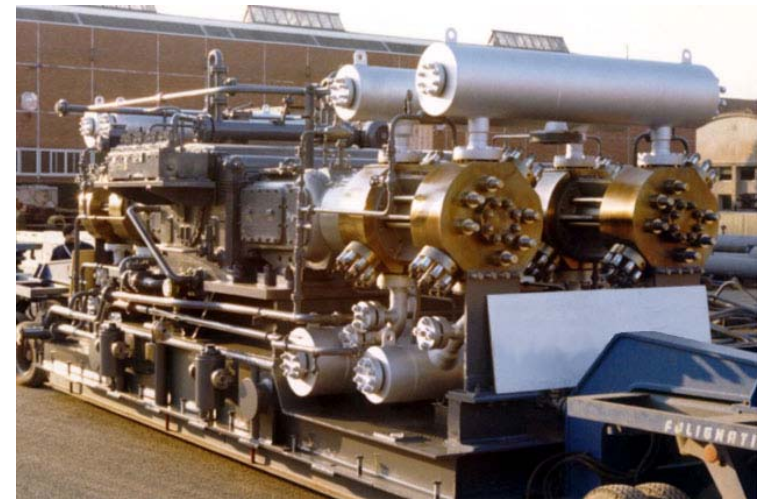
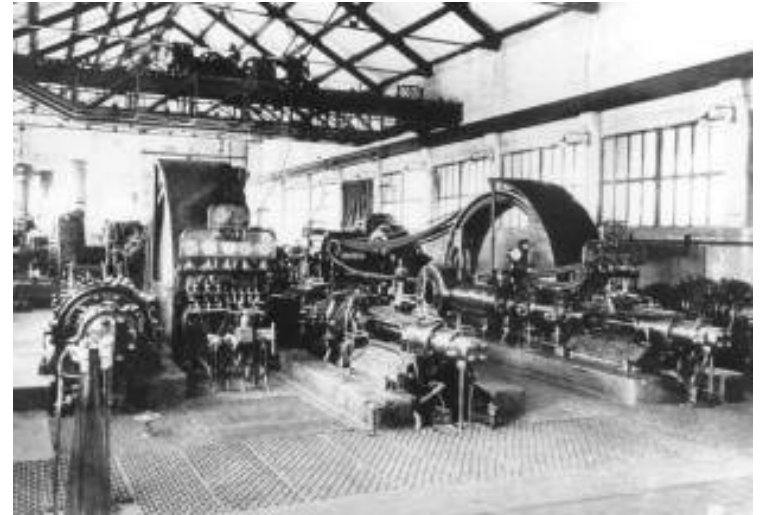

# CO<sub>2</sub> Centrifugal Compressor Experience



## References

- 200+ units installed since 1968
- Discharge pressure up to 280 bar/a
- Compressor power ... up to 18 MW
- Inlet flow ... 2,000 to 300,000 Nm<sup>3</sup>/h
- World's Largest Single Train capacity (3450 t/d QAFCO Qatar)
- 90+ Urea Plants ... 13 Million Operating hours

## Technical design challenges

- Aerodynamics
  - Very high pressure ratio and compressibility
  - Wide range of flow coefficient stages
- Rotor Dynamics
  - Very high density and destabilizing effects
  - Predictability of compressor seal dynamic coefficients

# CO<sub>2</sub> compression ... Rotordynamics

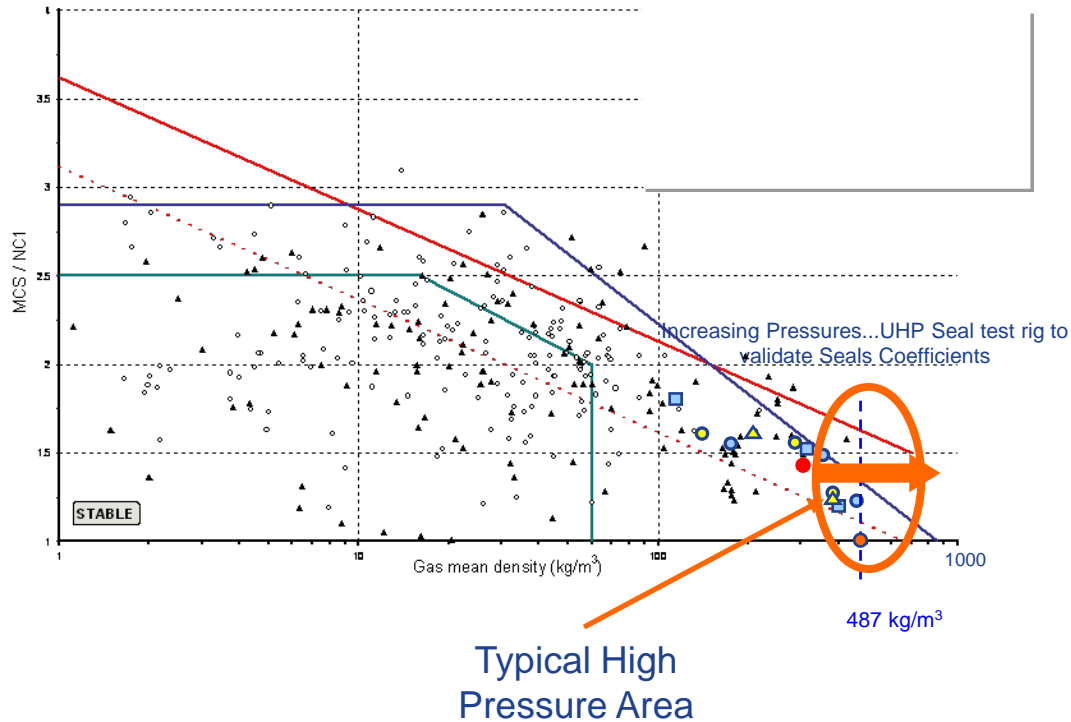

## Experimental validation of seals

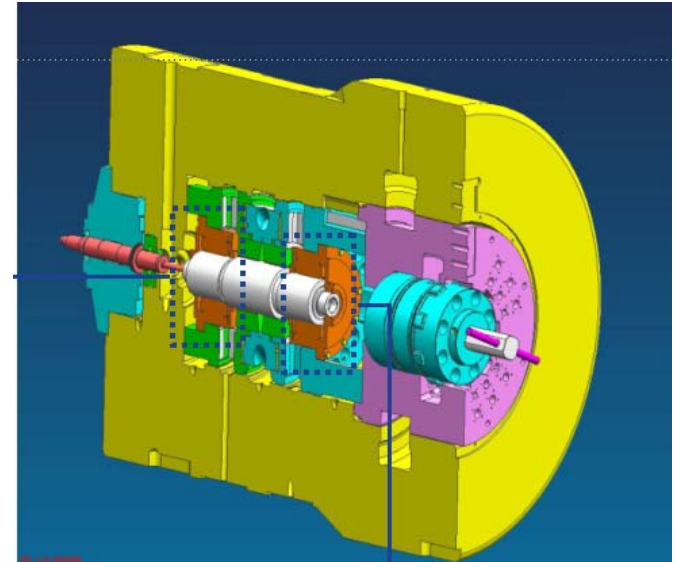

- Operating pressure : up to 400 bar
- Rotational speed: up to 18000 rpm
- Test gas: N<sub>2</sub>, CO<sub>2</sub>
- Design Pressure: 500 Bara

**Extensive Experience in High Density Applications ...  
Record discharge press with centrifugal  
compressor: 915 bar... UHP Seal Test Rig to move  
the boundaries**





# CO<sub>2</sub> Pumping Experience

## Brazil HP pilot project

- Custom designed mechanical seal qualification process
- Rotor dynamic stability assessment
- Physical properties of supercritical gas mixture tested by SWRI
  - Suction pressure 300 bar
  - Discharge pressure 540 bar
  - Design pressure 670 bar (API 6A 10000)
  - Flowrate 10 kg/s
  - Four pumps in series
  - Installation on FPSO
  - Triple mechanical seal configuration
  - Job delivery date: 31/12/2009

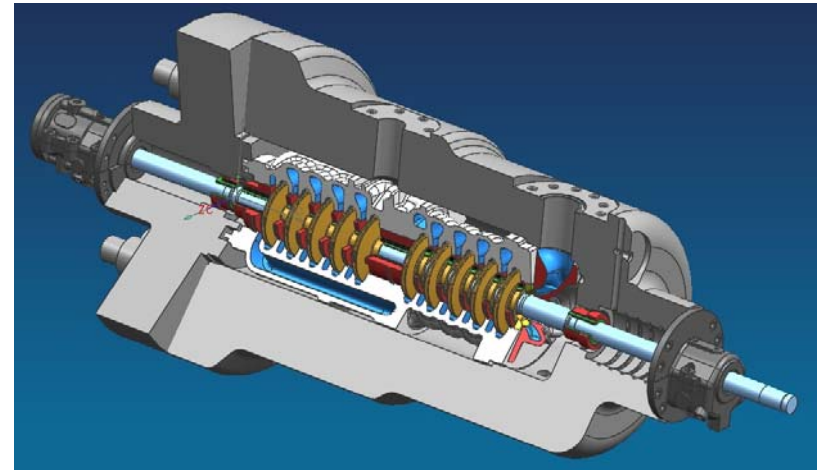

**First reference for this service**



# CO<sub>2</sub> Compression Summary

- Both compressor and pump technology in-house
- Compression + pumping thermodynamic optimization
- Many years of experience in CO<sub>2</sub> compression ... centrifugals and reciprocating
- Leverage experience in HP re-injection compression
  - Rotordynamics
  - Seals
  - Low flow stage aerodynamics
- Validation activities in place ... Gas properties and UHP test rig

# Questions

## Session 4.0



**Electric Drive Compressor  
Potential for Improvement in  
Capitol Cost, Power  
Requirements, Availability,  
and Safety**

## Session 4.1

A decorative orange banner with a central text box. The banner has a pointed left end and a pointed right end. The text box is a rectangle with a black border and a drop shadow, containing the title and author's name.

**High-megawatt Electric  
Drive Applications in  
Oil and Gas**  
Zhang

# High-megawatt Electric Drive Applications in Oil & Gas

## Workshop on Future Large CO<sub>2</sub> Compression Systems

March 30, 2009

Richard Zhang

GE Oil & Gas



# Oil & Gas Applications for Turbo Machinery

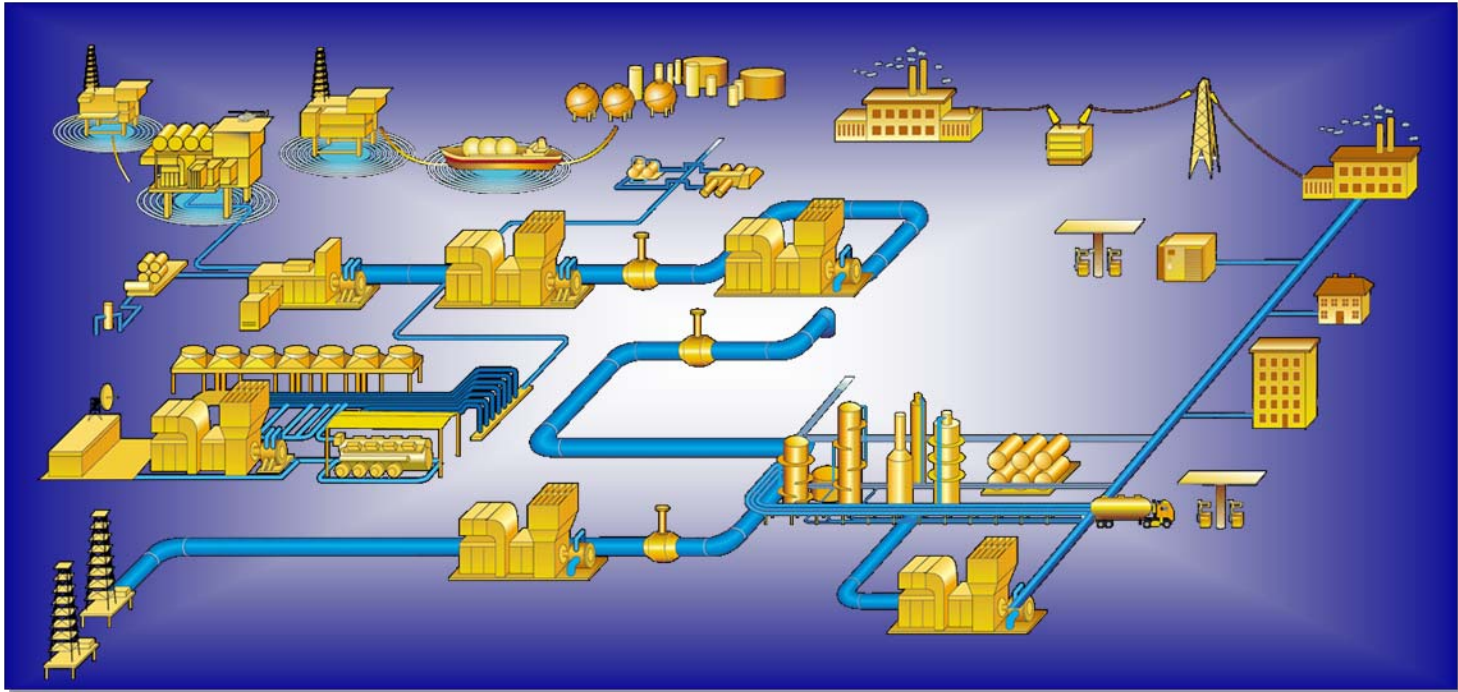

**Exploration  
Production**



**Transport**



**Processing**



# A Typical Conventional Compression Train

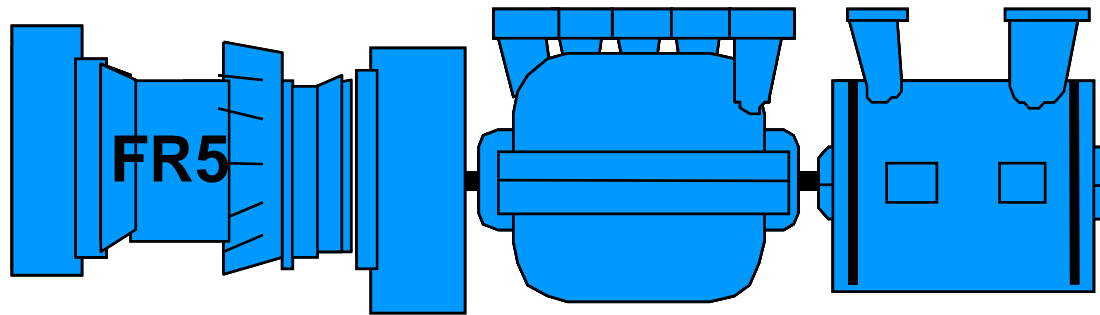

- **Gas Turbine + Compressor**
- **Fixed low speed operation**
- **Efficiency/emission limit**
- **Maintenance cycle**



# A Changing World ...

## Scenario

## Challenges



Demographics & industrialization

Limited resources



Supply / demand disconnects

Spare capacity



Elevated cost of energy

Unconventional energy sources



Increasing environmental regulations

Reduced emissions



Higher investor / stakeholder expectations

Cost control

# World Is Going More Electric

## Power Generation & Distribution

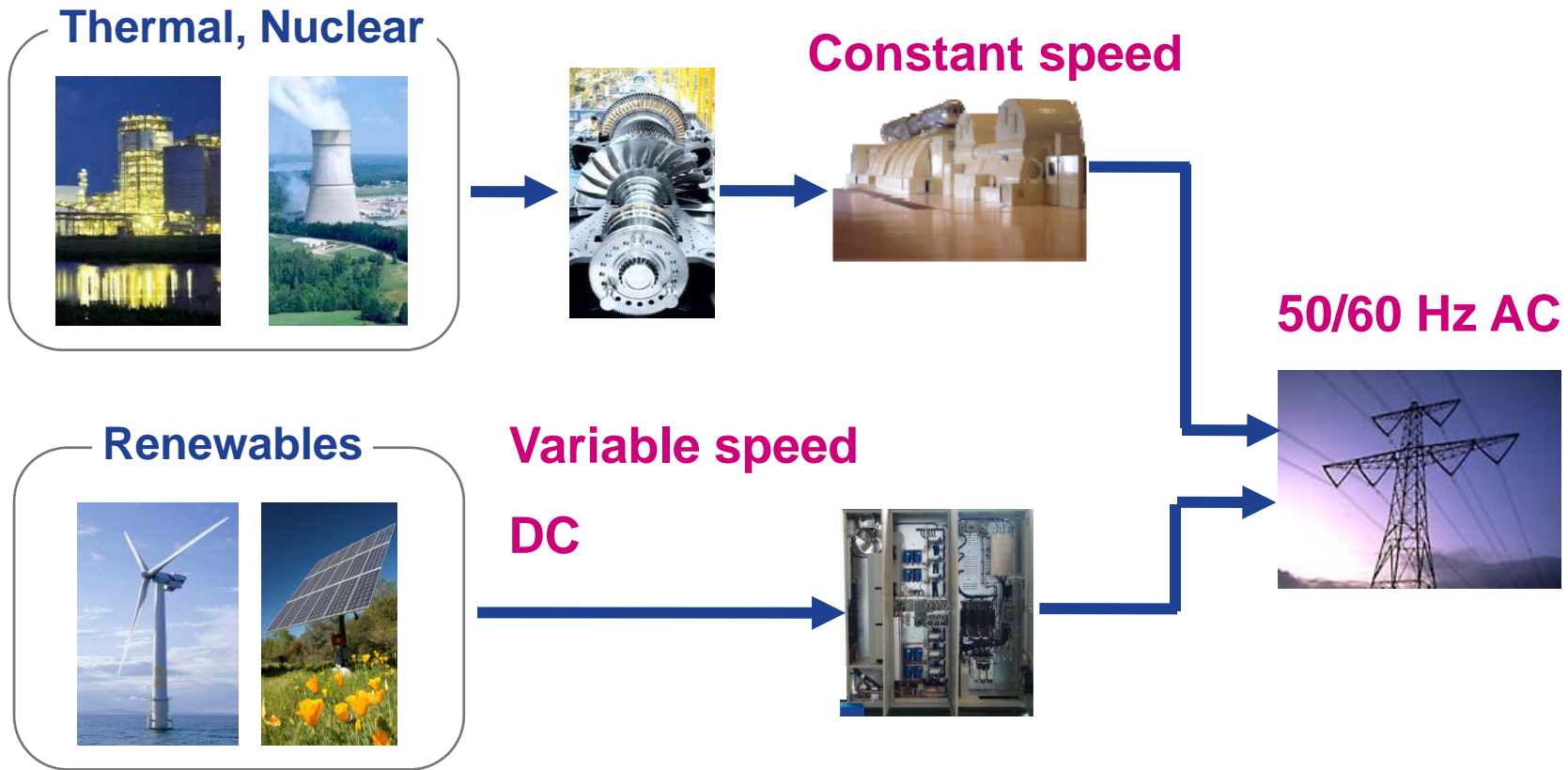

- Synchronous
- Mechanical/Electromagnetic Conversion

- Centralized grid

- Asynchronous
- Electronic Energy Conversion
- Mini and distributed grid

# World is Going More Electric – Prime Mover

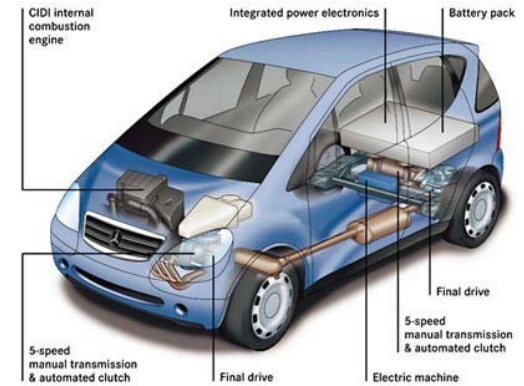

**More Electric or All Electric Prime Movers**





# Oil & Gas Electrification

**World Largest LNG Train from GE (8 MTPY)  
tested in Massa, Italy**

# Electric Drives in High Power Compressor Trains

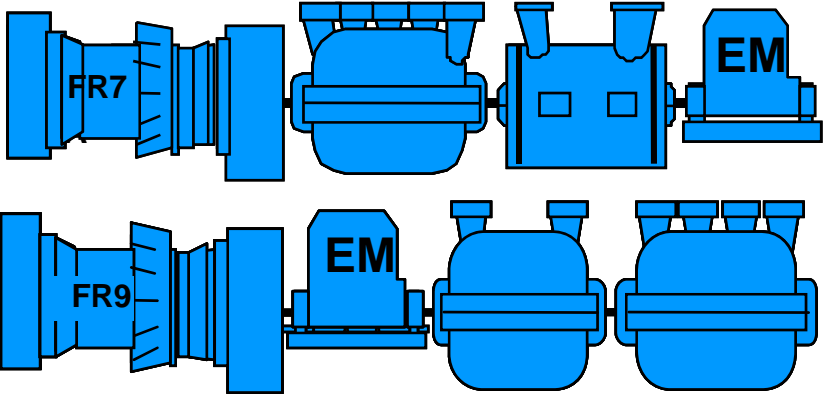

## Needs & Challenges

- High power > 10 MW
- High reliability
- High performance
  - low torque ripple
  - low grid harmonics

### Full electric Trains

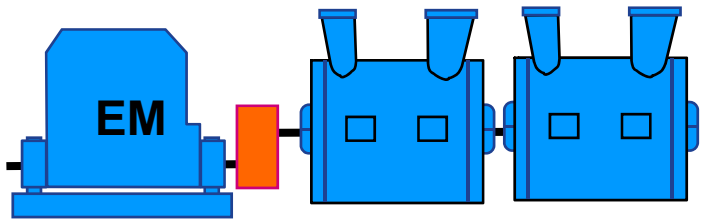

### HS Electric-driven Trains

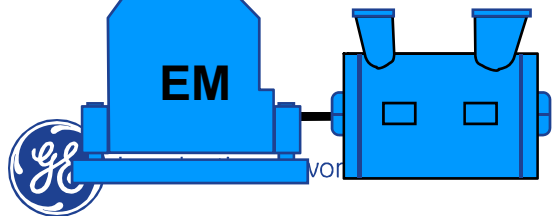

# Very High Power to Ultra-High Power

## Drives: LNG/e-LNG example

### LNG

(Gas Turbine Driven )

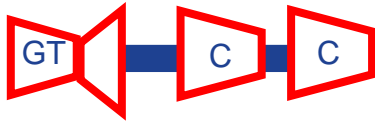

- Higher Availability
- Higher Power
- High Power Quality
- Lower Emission
- Higher Efficiency

### LNG Super Train

(Gas turbine driven w/ electric drive)

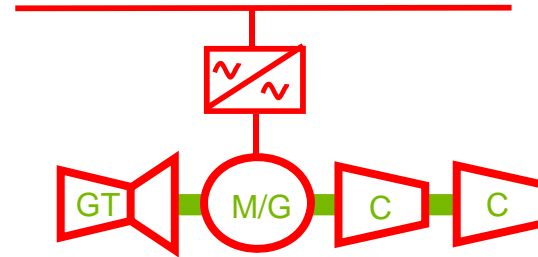

### e-LNG

(Electric driven)

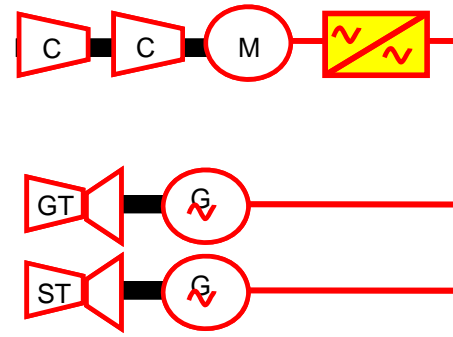

# High Power High Performance Drive Example

## Challenges

- High power 35MW @ 100Hz
- Low torque ripple
- High reliability

## Solutions

- > Multi-thread parallel
- > Interleaving control
- > Less parts-count & proven building block

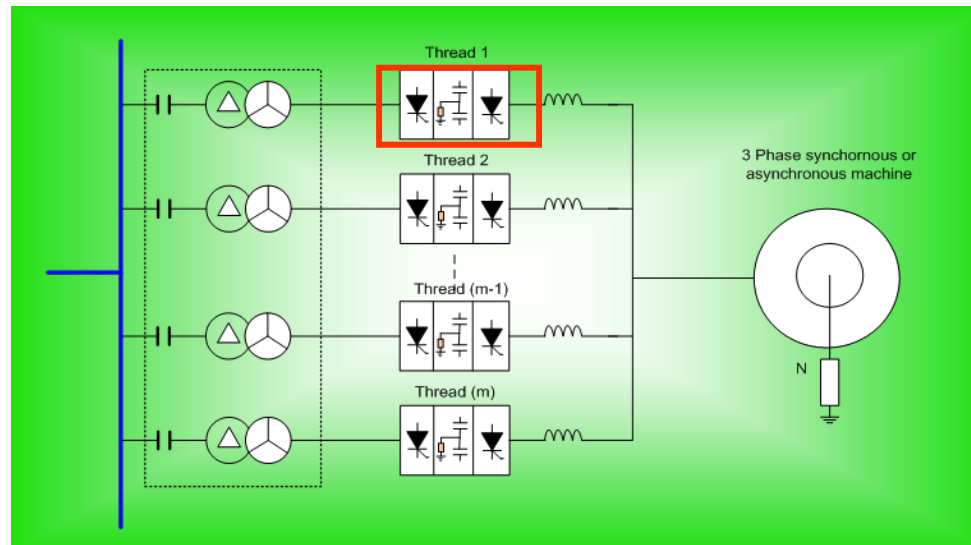

High Reliability - High Quality Waveform

# 35 MW Drive System Test Results at GE Oil & Gas

Massa Testbed,  
Italy



35 MW, 110 Hz capability

## Inverter Currents

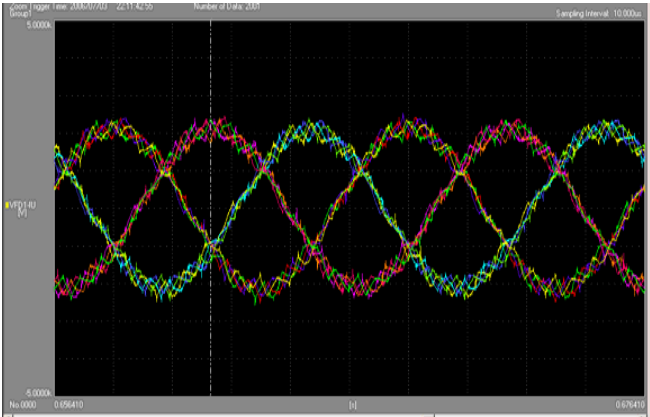

## Motor Current

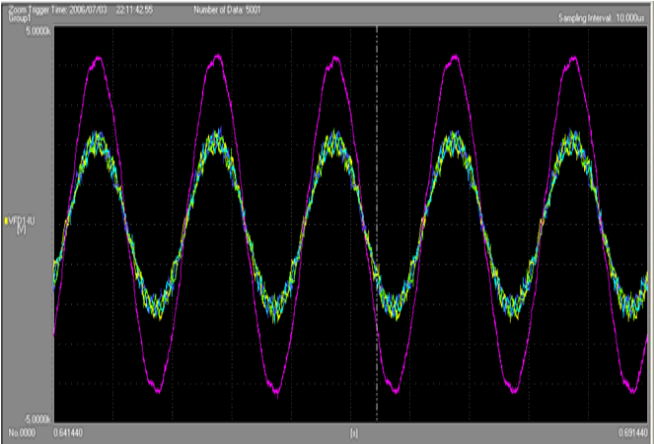

High waveform quality and less complexity



# Performance Comparison with LCI

## Motor Mechanical Torque Ripple (steady state)

**LCI**

**IGCT Drive System**

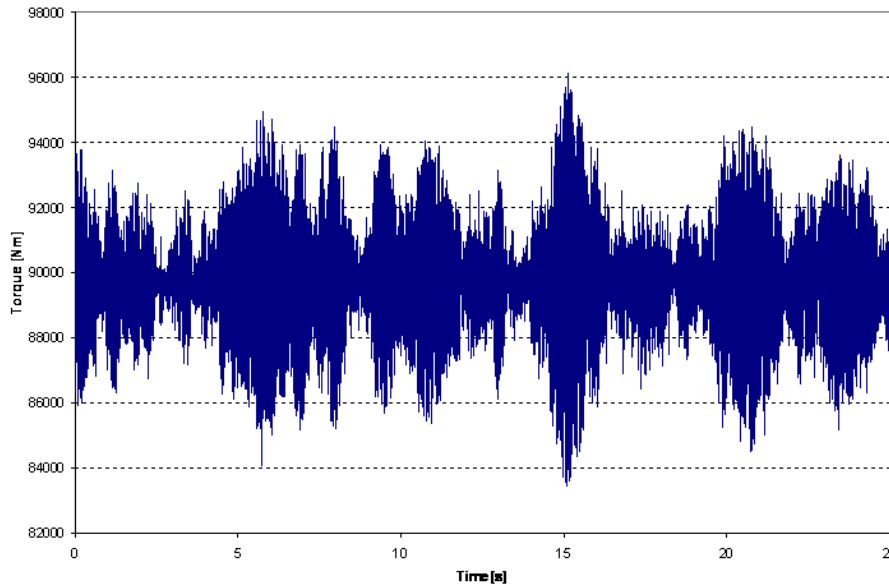

Torque Ripple: 14.8% @  
31MW 3400rpm

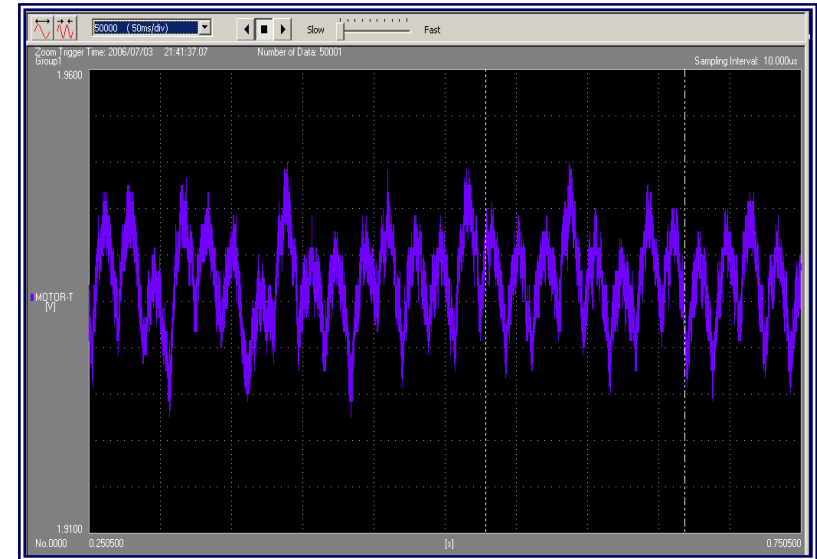

Torque Ripple: 3,7% @  
30MW 3300rpm

**Torque Ripple reduced by more than 3x**

# High Speed High Power Direct Drive Compression

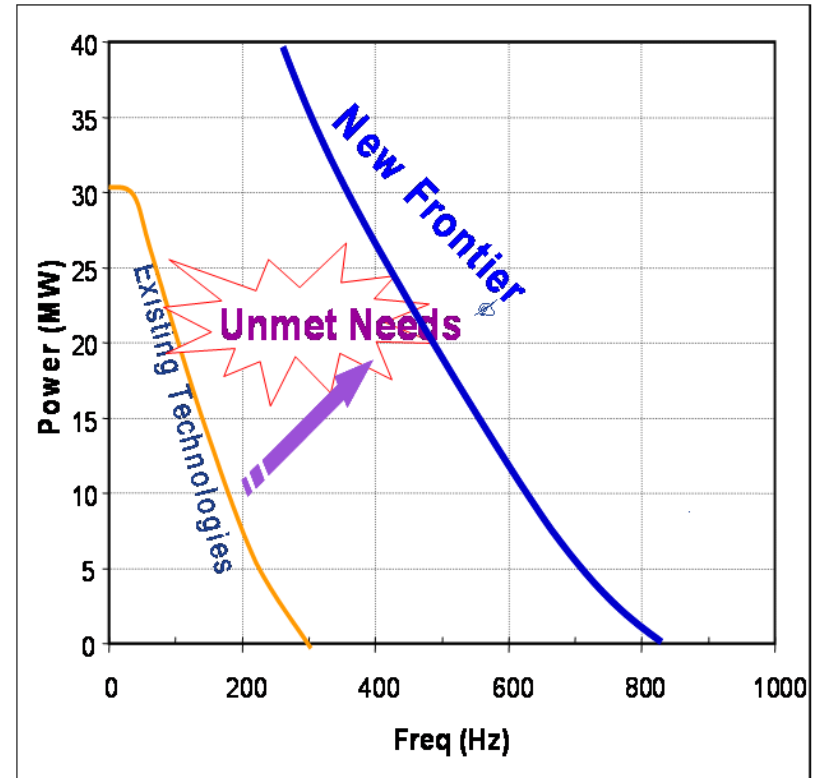
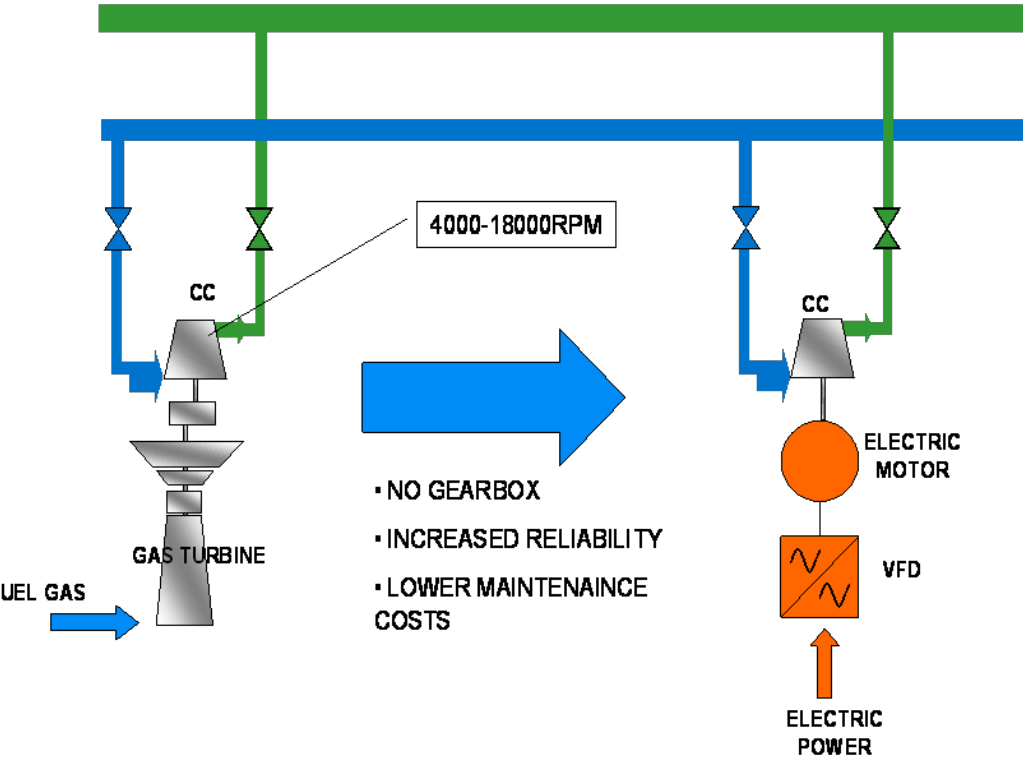

# Applications

- **Transportation**

- Pipeliners
- Storage

- **Natural Gas**

- Sales Gas
- Export
- Dry Clean Gas Services

- **Downstream**

- Feed Gas
- Fuel Gas Boosters

- **Integrated high speed motor-compressor**

- **Serve the O&G segments up to 15 MW**

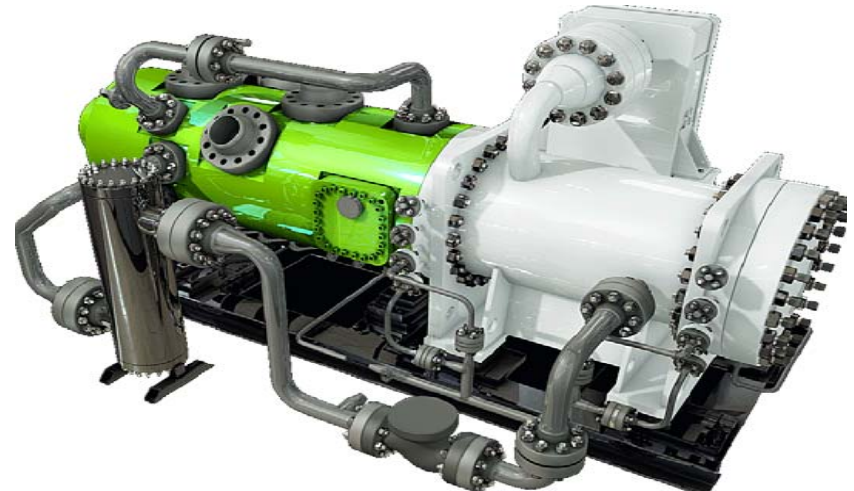

## **Integrated Compressor Line :**

Simple to install

Easy to operate

Environmentally friendly

# Subsea ... Next Frontier

## Future Demands/Technologies:

- Long Stepout
- Deeper waters
- Increased power
- Multiple loads

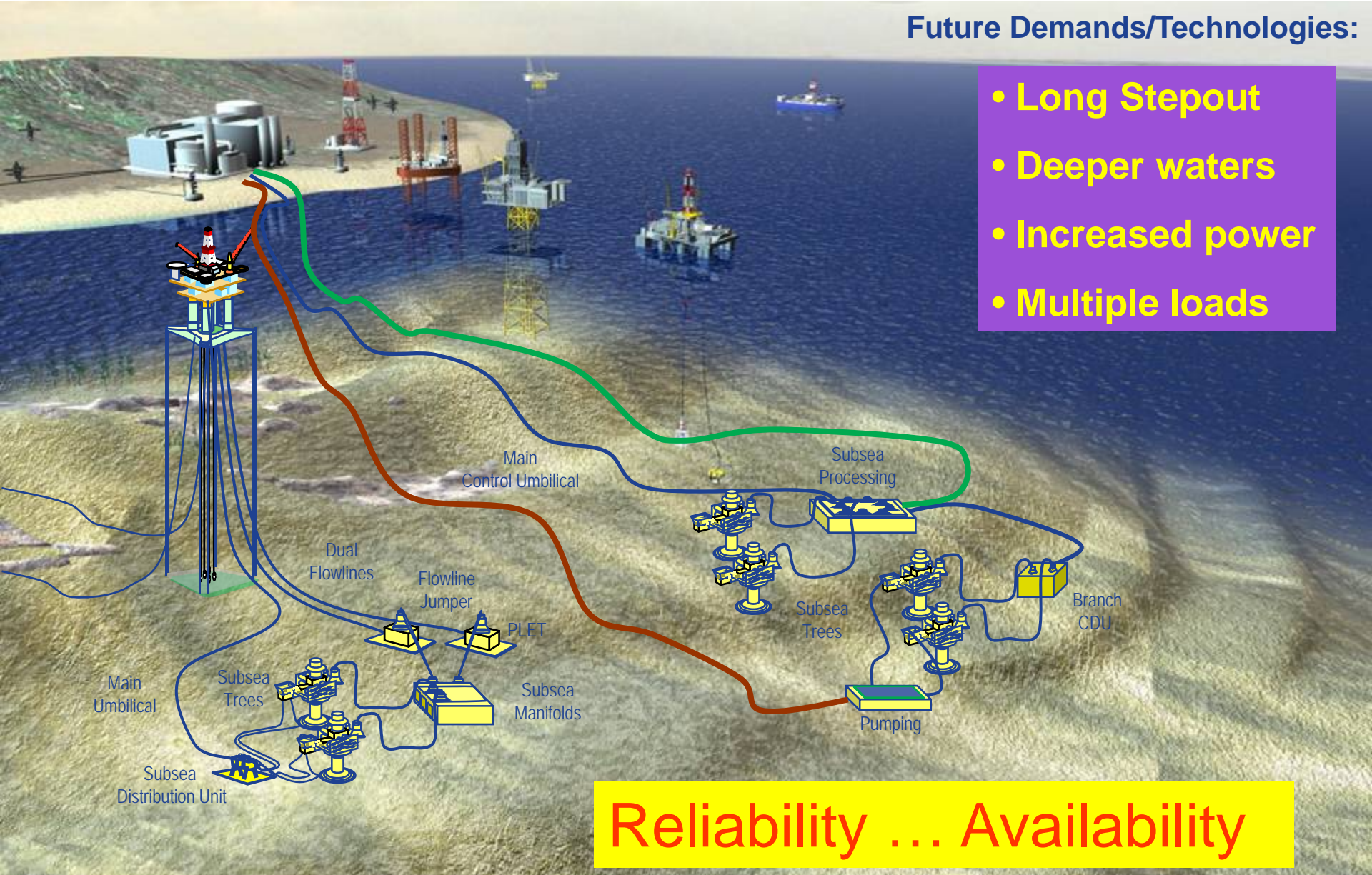

**Reliability ... Availability**

# High Power Electric Drives for Oil & Gas Applications

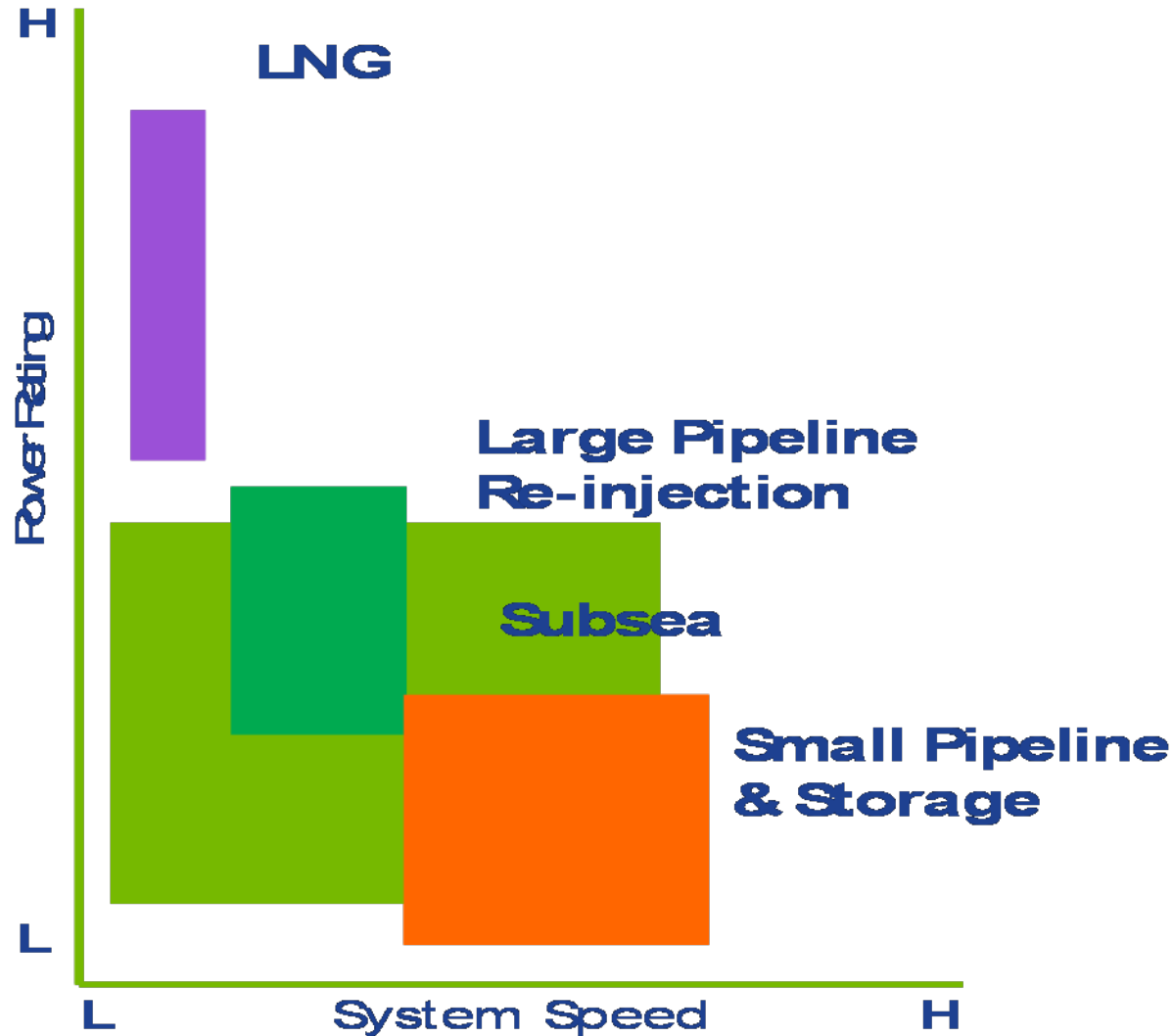

# Conclusions

- World is going More Electric ... happening in Oil & Gas industry too
- Diverse range of applications for high power electric drives started to emerge
- Many new applications call for new technologies
  - High reliability/availability/maintainability
  - High power
  - High voltage
  - High speed
  - Harsh environment
  - ...



imagination at work

**Questions?**

## Session 4.2



**High-megawatt Electric  
Drive Motors**  
Kullinger





Kenneth Kullinger 2009-03-23

# High-megawatt Electric Drive Motors

# High-megawatt Electric Drive Motors Presentation Content

- Total cost of operation
- Large synchronous motors
- Starting methods
- High-megawatt compressor drives
- Very High Voltage motors
- References
- Summary





# Total cost of operation (TCO)\*

## TCO includes:

- Purchase price
- Specifications
- Transportation
- Storage
- QA
- Reliability
- Electricity
- Repairs
- Administration
- Inventory
- etc

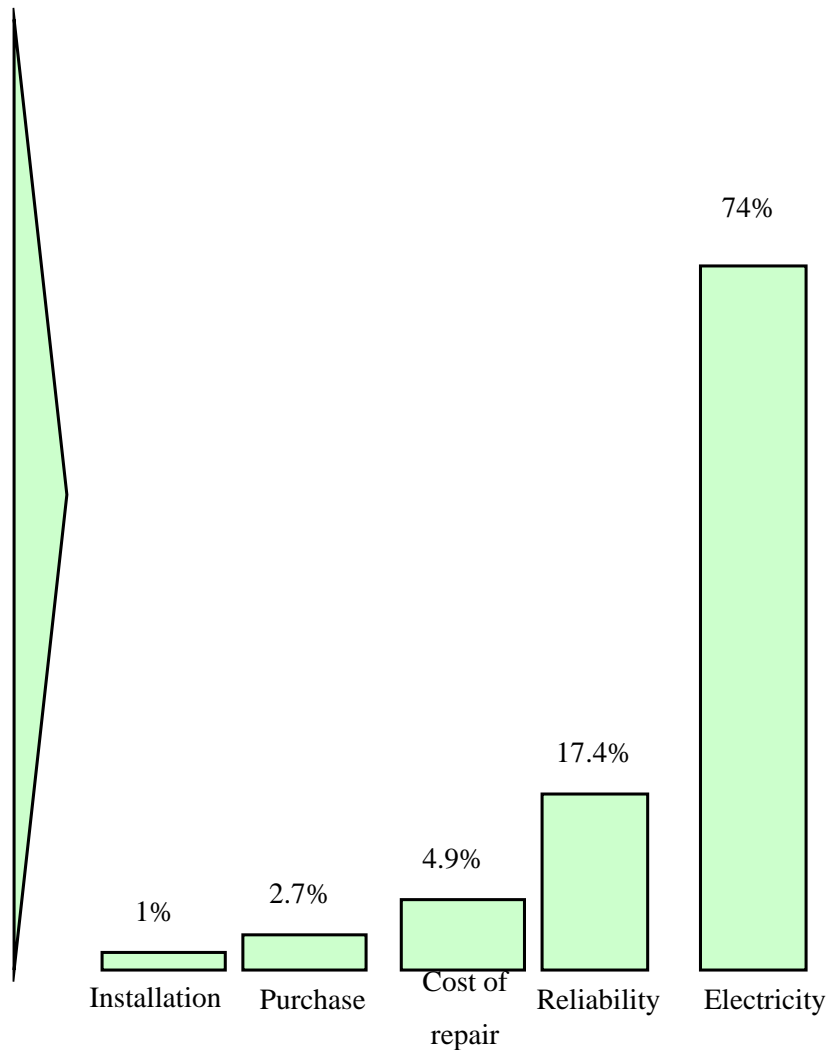

\*Information provided by Machinemonitor based on survey of 6000 machines

# Large Synchronous Motors

- 4-6 pole synchronous compressor motors
- 10 - 60 MW
- 3-150kV
- Efficiency >98%
- Direct on line or VSD/VFD applications

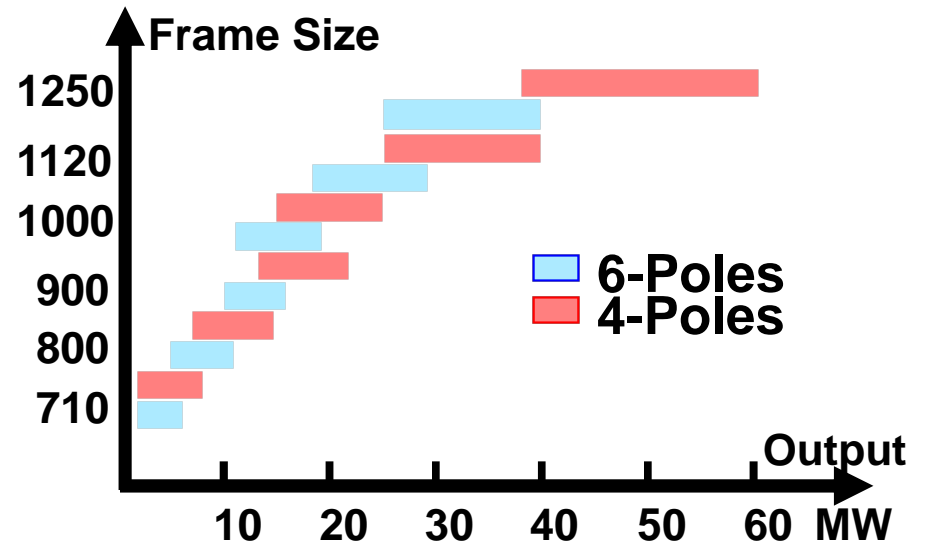
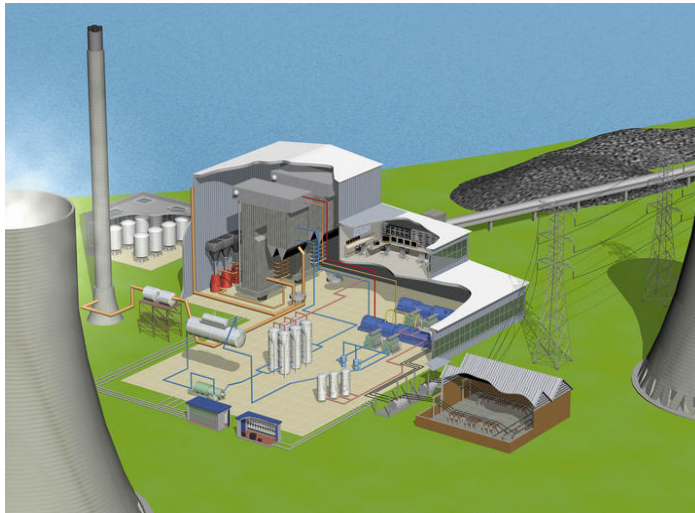

# Synchronous Motor Concept

- Features
  - High efficiency
  - Low inrush current
  - Variable power factor
- Rotor design characteristics
  - Salient solid rotor
  - Forged shaft for heavy duty service
  - Brushless exciter

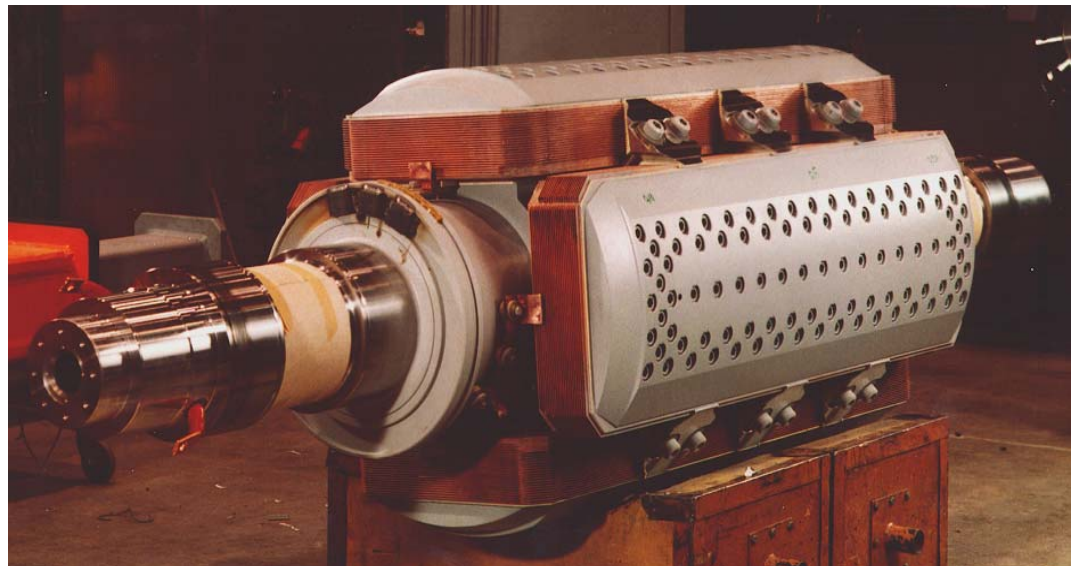
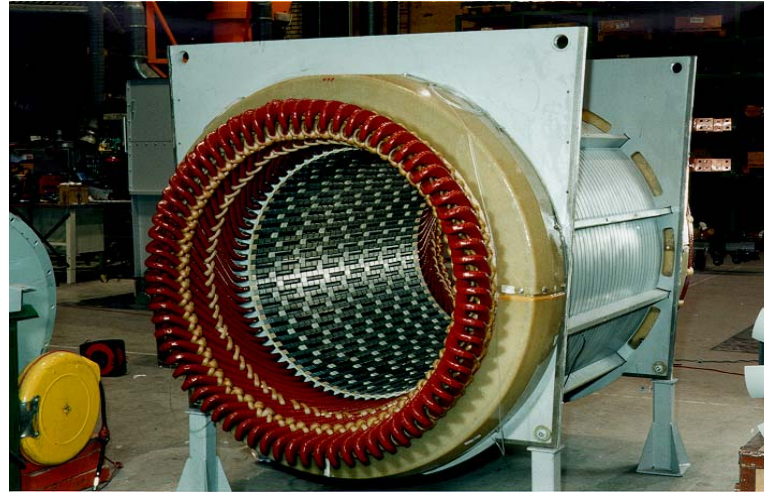

# Considerations when Selecting Starting Method

- Short circuit capacity on the network
- Maximum allowed voltage drop on the terminals during start
- Minimum starting torque to give a safe acceleration and synchronization for synchronous motors
- Maximum starting torque not to exceed the allowed shaft torque during start



# Starting Methods:

**Direct on line starting**

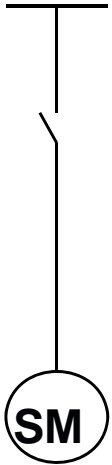

**Reactor starting**

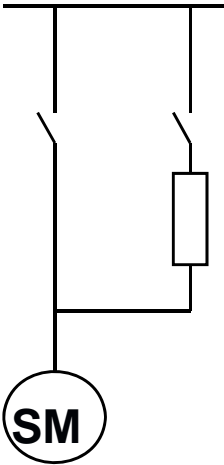

**Capacitor starting**

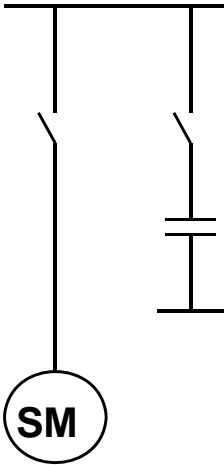

**Reactor + capacitor starting**

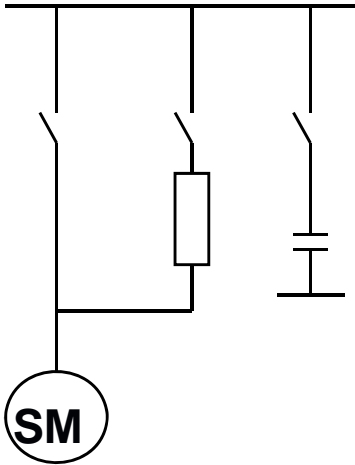

**Transformer starting**

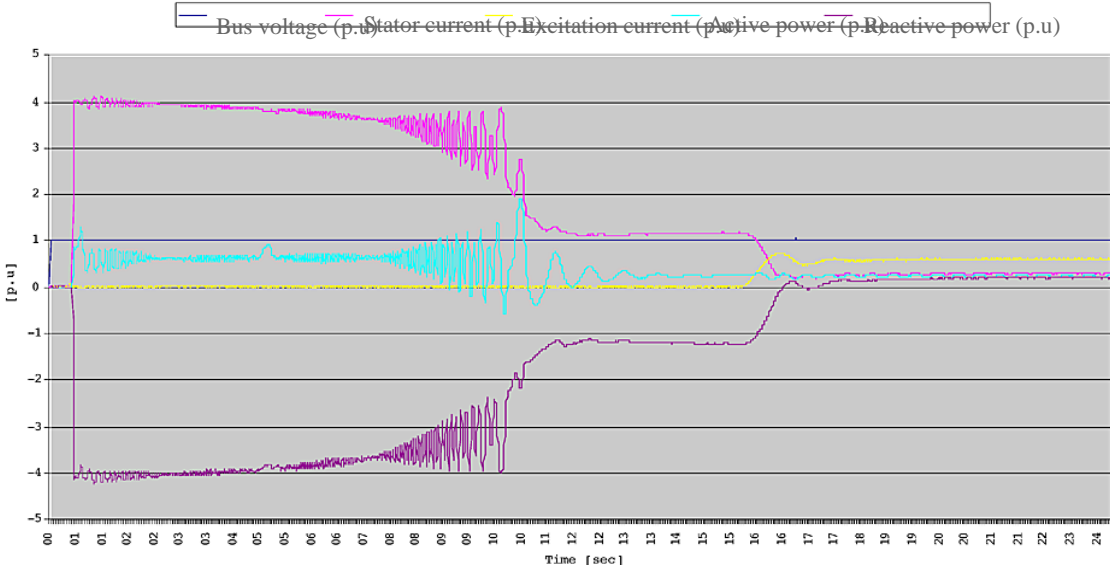
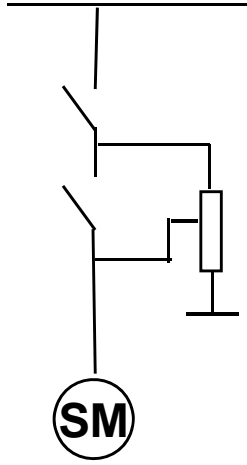

**Frequency controlled starting**

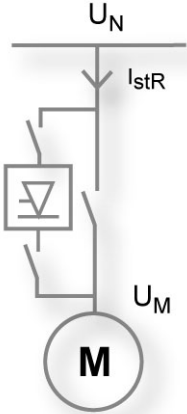

# High-megawatt Compressor Motors

- +40 years experience driving large compressors
- Adaptable for harsh environments Hot, Cold, Hazardous Area
- Water cooled or Air cooled
- Suitable for multiple compressor applications Gas injection, Pipeline, Air separation, Gas oil separation etc.
- Pf control for weak network





# Very High Voltage Machines

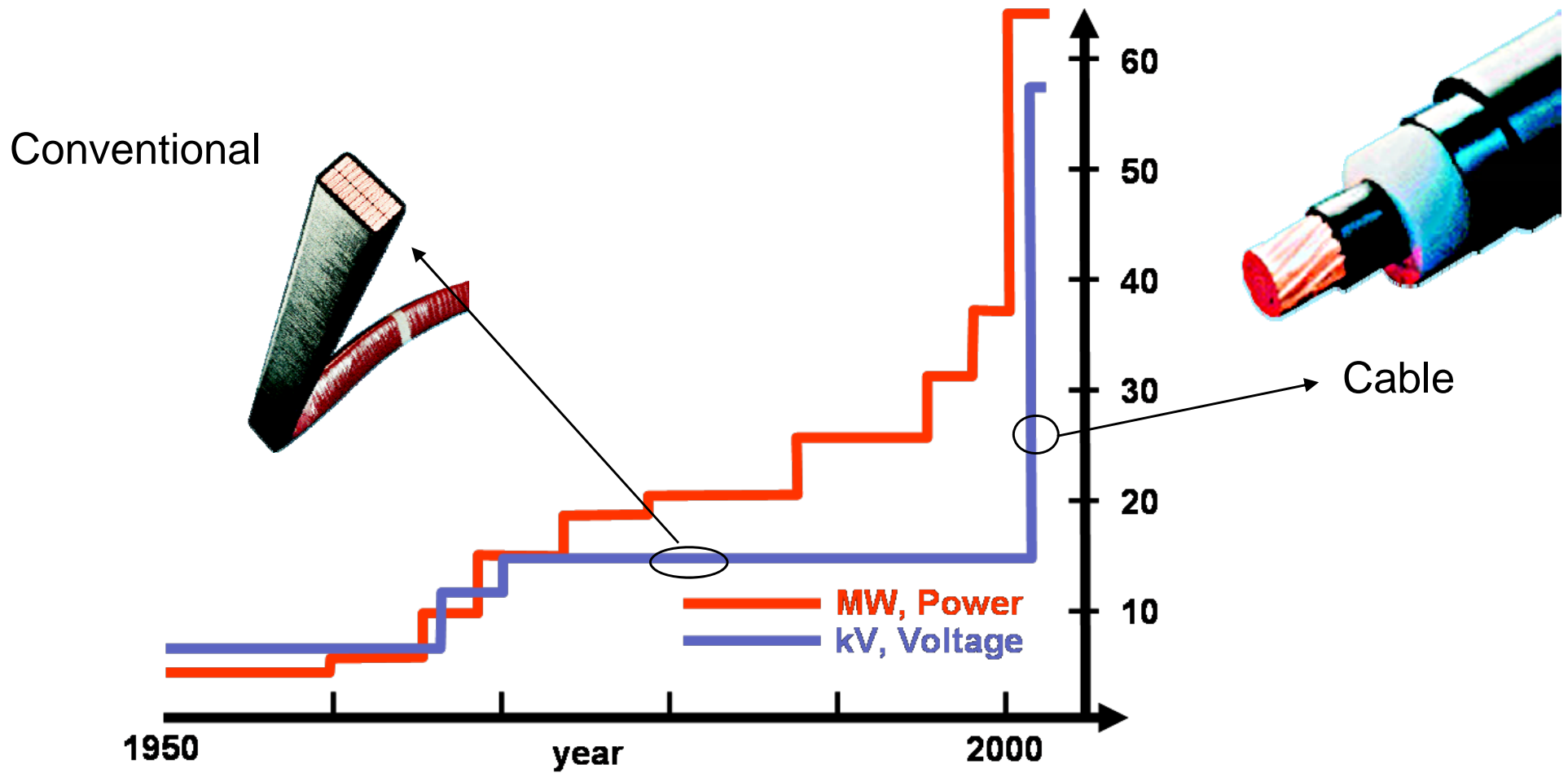

# VHV Synchronous Machines - AMT

- Connection
  - Direct to high voltage grid
  - Variable speed with HVDC – light converter supply
- An innovation creating a brand new motor concept
  - Motorformer™ : 5 - 50 MW
  - 20 - 70 kV
- Eliminates the need for a transformer
- Higher total efficiency
- Less space than conventional installation



# References

A selection of compressor motors >30MW.

Customer	No	User country	Starting	MW	Industry	Delivery
Linde	2	UAE	Soft start	59	Air Separation	2010
Air Liquide	2	South Africa	Soft start	55	Air Separation	2001
Statoil	2	Norway	HVDC	44	COG	2008
Wuhan steel works	3	China	Soft start	42	Metal (Blower)	2003
Linde	2	UAE	Soft start	40	Air Separation	2010
JSW	3	India	Soft start	40	Metal (Blower)	2007
Air Liquide	1	Italy	Soft start	40	Air Separation	2008
NIGC	2	Saudi Arabia	Soft start	35	COG	2003
BP	2	Azerbaijan	DOL	33	COG	2002
In Salah	2	Algeria	VSD	12	CO2	2001



# Summary

- Synchronous 4-6 pole high-megawatt motors are commonly used for large compressors in air separation and various gas compression applications
- Highest installed power reference is 59 MW
- SM motors are a proven reliable compressor drive technology
- High efficiency is key to total cost optimization
- Very high voltage is a new technology opportunity

Power and productivity  
for a better world™



## Session 4.3



**Multi-Megawatt Motor  
Drive Technology**  
Moran



# Multi-Megawatt Motor Drive Technology

Steven Moran 30 March 2009

# CONVERTEAM AT A GLANCE

- **Converteam – an engineering company with more than 100 years experience providing customized solutions**
- **These solutions are made of systems built around 3 core components:**
  - Rotating Machines
  - Variable Speed Drives
  - Process automation & control
- **We address 4 major markets:**
  - Marine
  - Oil & Gas
  - Energy
  - Industry
- **Our scope covers consulting, design, manufacturing, system integration, installation, commissioning and a broad range of services**

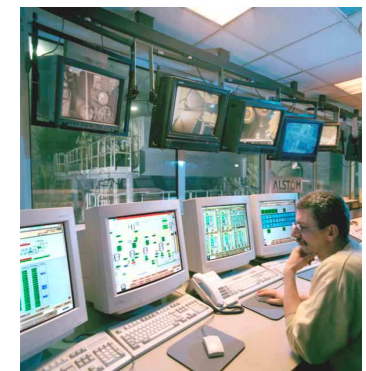



# MORE THAN 100 YEARS OF EXPERIENCE

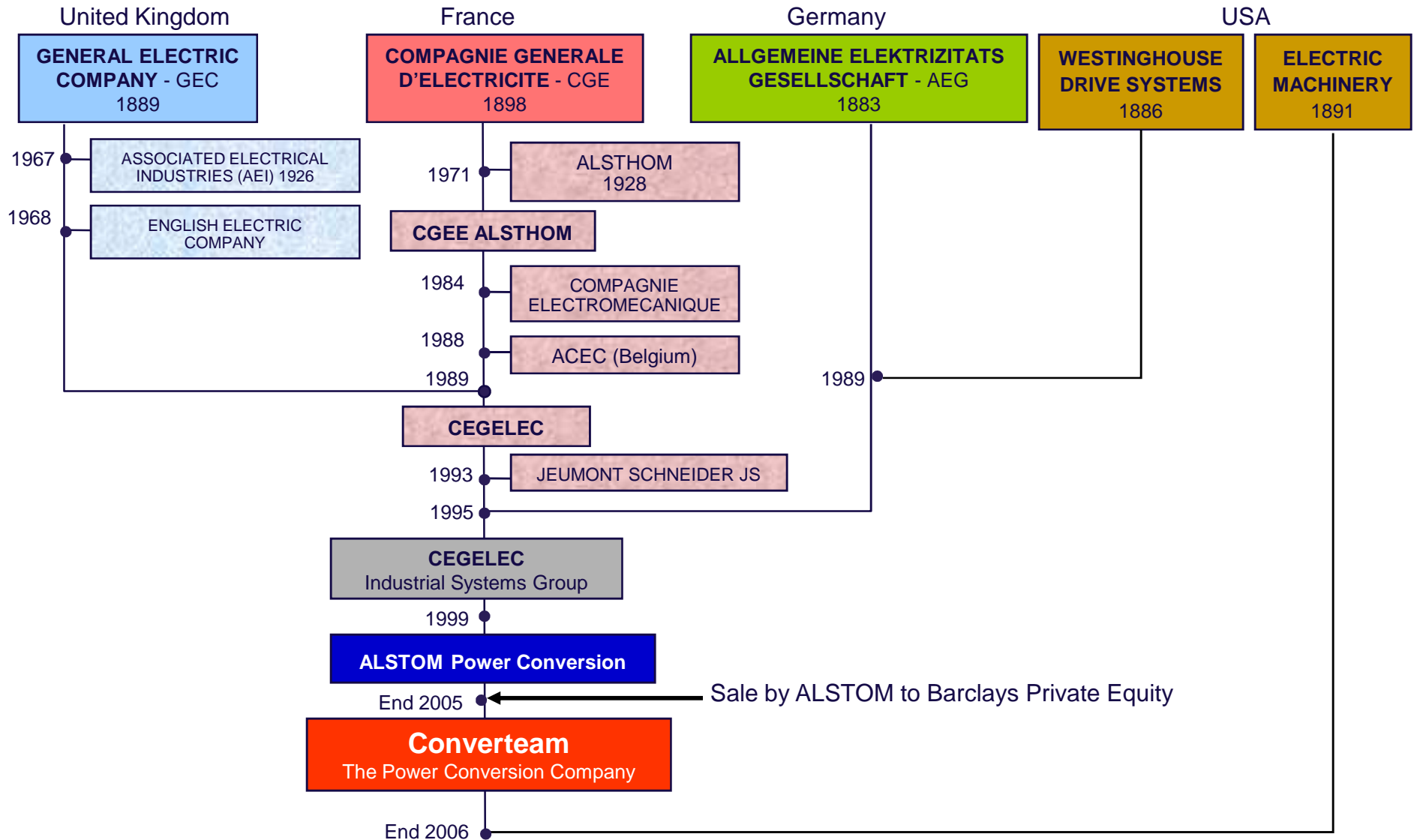

# Oil & Gas Market: CVT Scope of Supply

In Oil & Gas, scope of supply corresponds to electrical systems which drive compressors or pumps ...  
... and correspond to power supply of O&G process ...

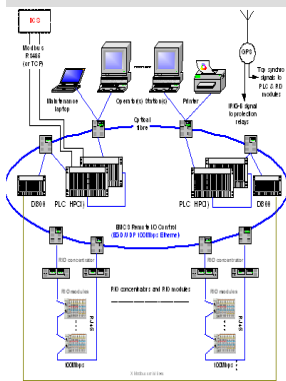
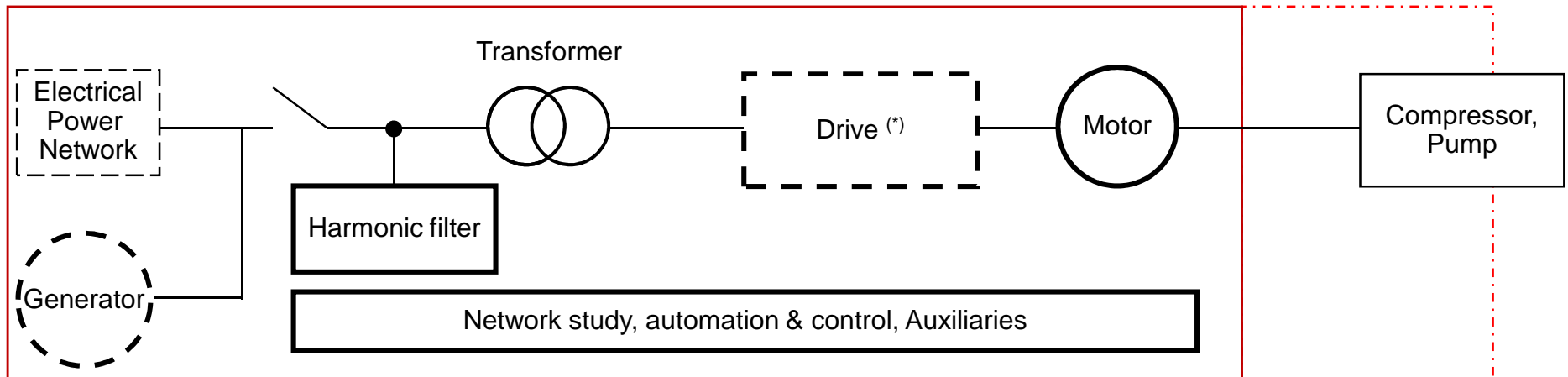

Electrical Control

Switchgear

Harmonic filter

Drive

Motor + compressor

Auxiliaries

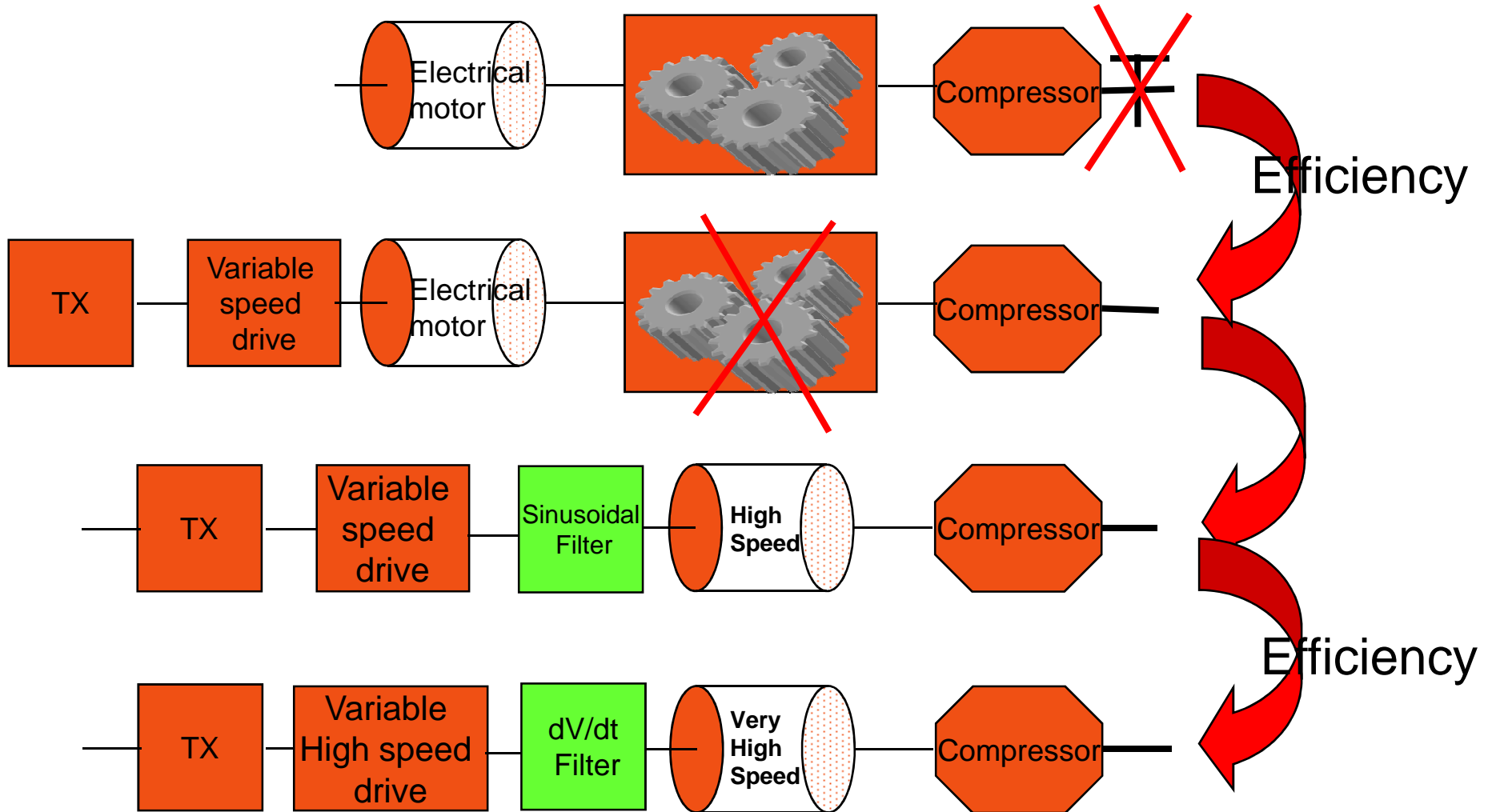

# Gas compression: Electrical Solutions



## Converteam MV 7000 Systems

<b>VARIABLE SPEED DRIVE SYSTEM</b>			
<b>TYPE</b>	<b>POWER</b>	<b>MOTOR TYPE</b>	<b>TECHNOLOGY</b>
<b>MV7000</b>	<b>2 to 32 MW</b>	High speed motor Induction motor Synchronous motor	<b>MV- IGBT press pack</b>
<b>SD7000</b>	<b>10 to 100 MW</b>	Synchronous motor High speed synchronous motor	<b>LCI - Thyristors</b>

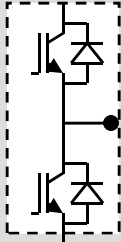
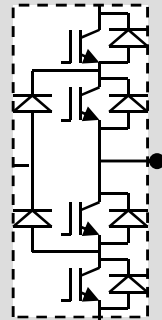
# MV Drives Topology Comparison

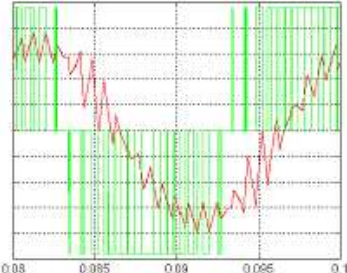
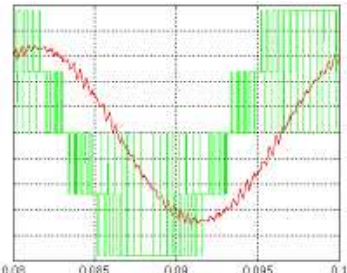
Topology	2-Level inverter	3-level NPC	3-Level NPP
Performances			
Output voltage & current			Switching frequency x 2  50% reduction of current ripple
Applicable to	LV drives	MV drives	MV drives
Drive series	MV3000 – MD2000 – LV7000	MV 7000	MV drives next generation
Power	Up to 3 MW	up to 32 MW	up to 46 MW
Voltage	690 V	3.3 - 6.6 kV	3.3 - 6.6 kV
Current in motor	3140 A rms	2800 A rms	4025 A rms

## MV7000 VFD Range

MV7000 Range	Voltage	Power (MW)
MV7306	3300	6
MV7308	3300	8
MV7312	3300	12
MV7316	3300	16
MV7403FP (air-cooled)	4160	3
MV7406FP (air-cooled)	4160	6
MV7612	6600	12
MV7616	6600	16
MV7624	6600	24
MV7632	6600	32

### Main features of the drive system:

Uses a PWM inverter for the motor and one of the following front ends:

- 12 pulses diode front end (option- Active front end)
- 24 pulses diode front end (option- Active front end)

**A family of drives up to 32 MW**

# MV7000 Today's Technology

## MV7306

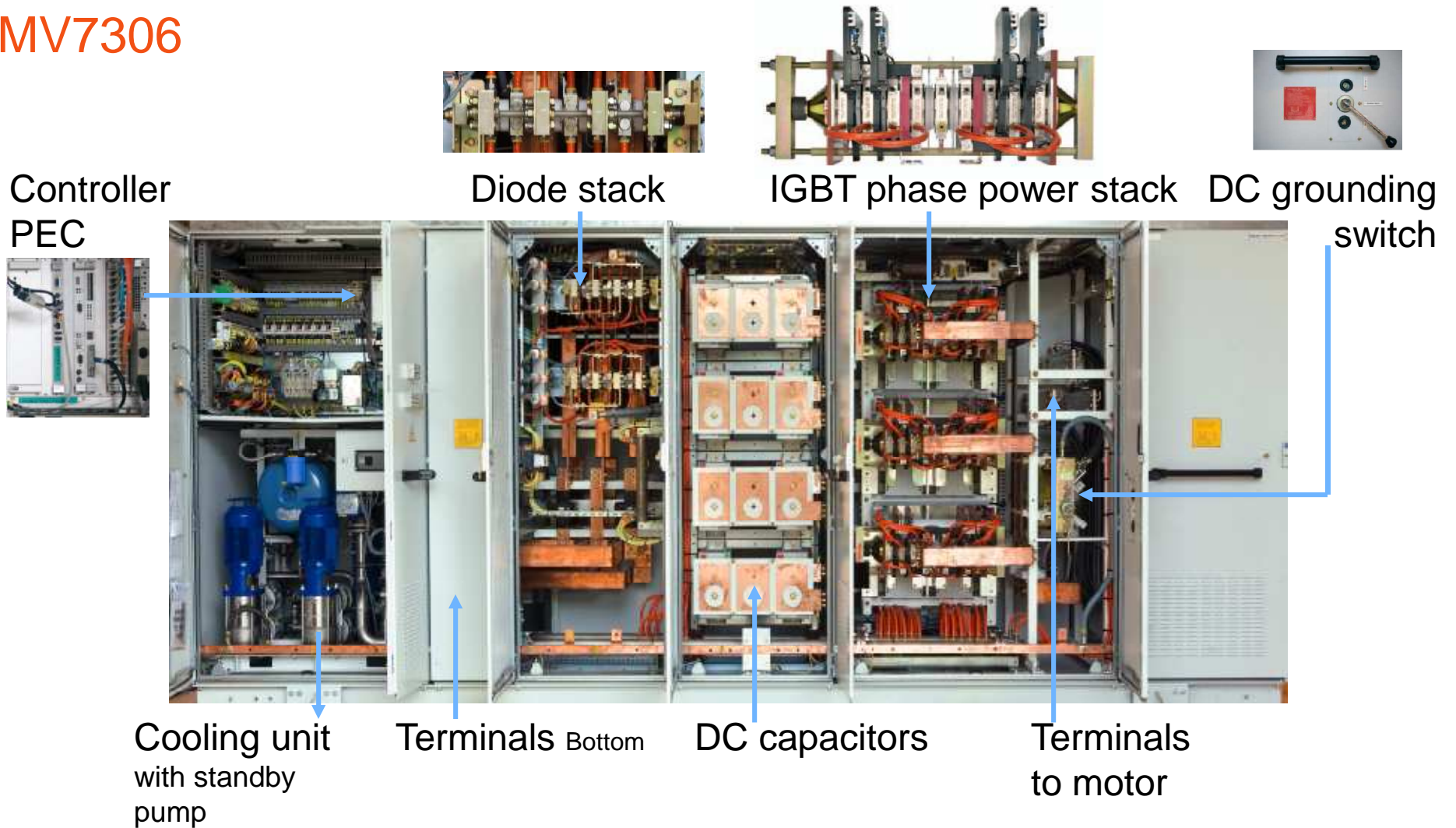

## Inverter - phase leg: the heart of the converter

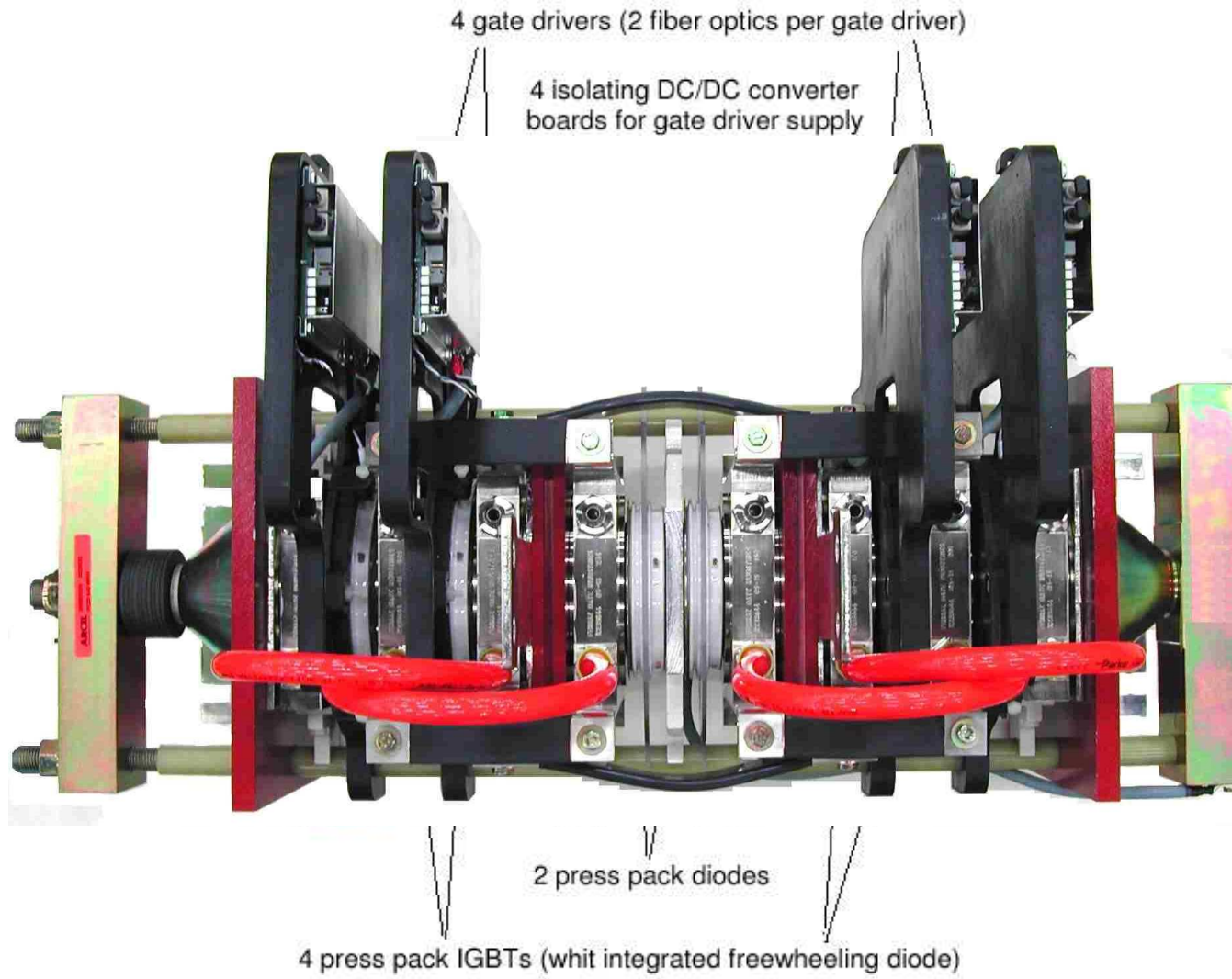



## Soft start-up without grid disturbance

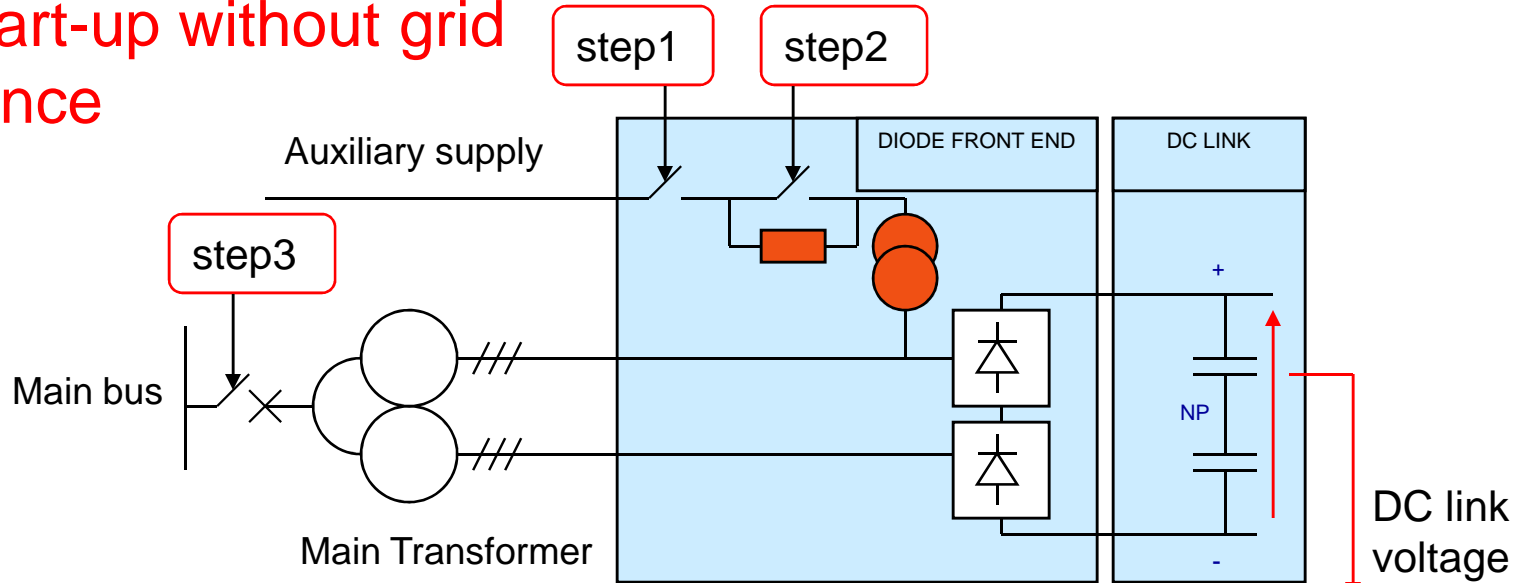

- MV7000 provides low inrush current when energising the drive
- Pre-magnetising of the input transformer is achieved by means of auxiliary transformer.
- Closing of main circuit breaker is completed without incoming bus disturbances

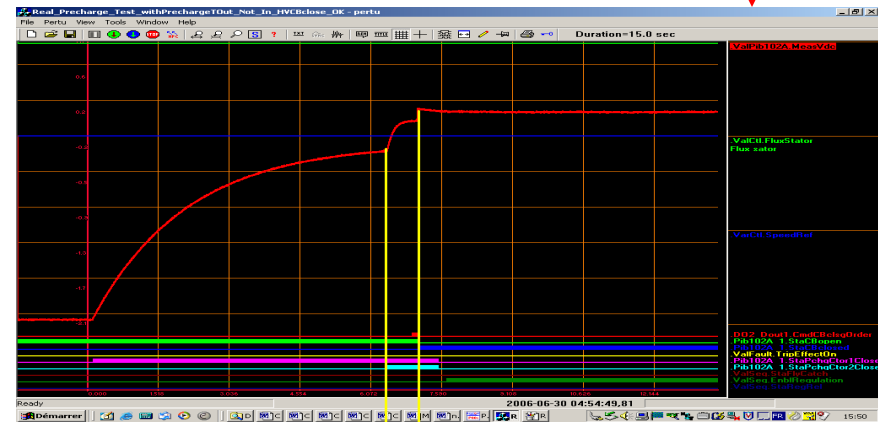

# Electrical One-Line

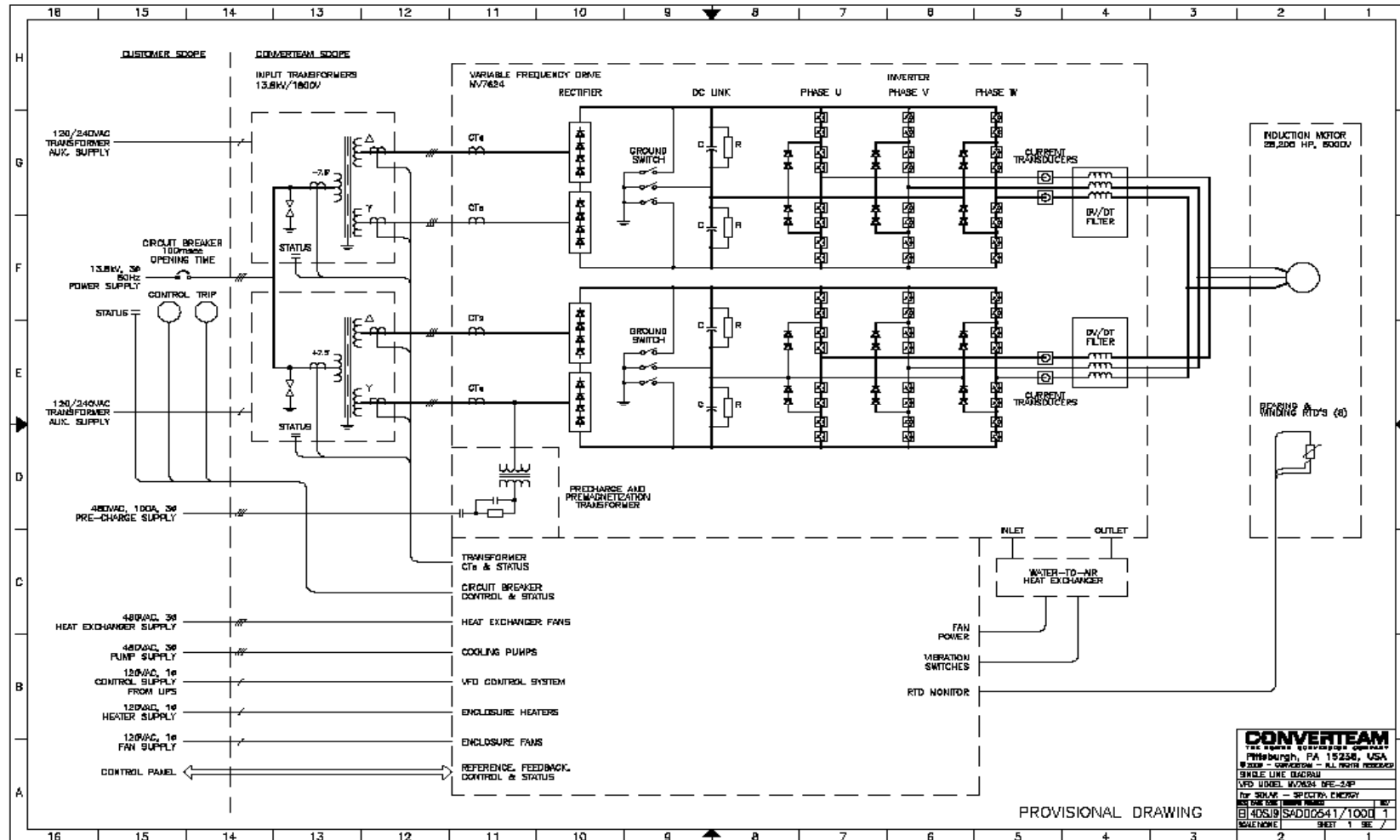

# Active Front End

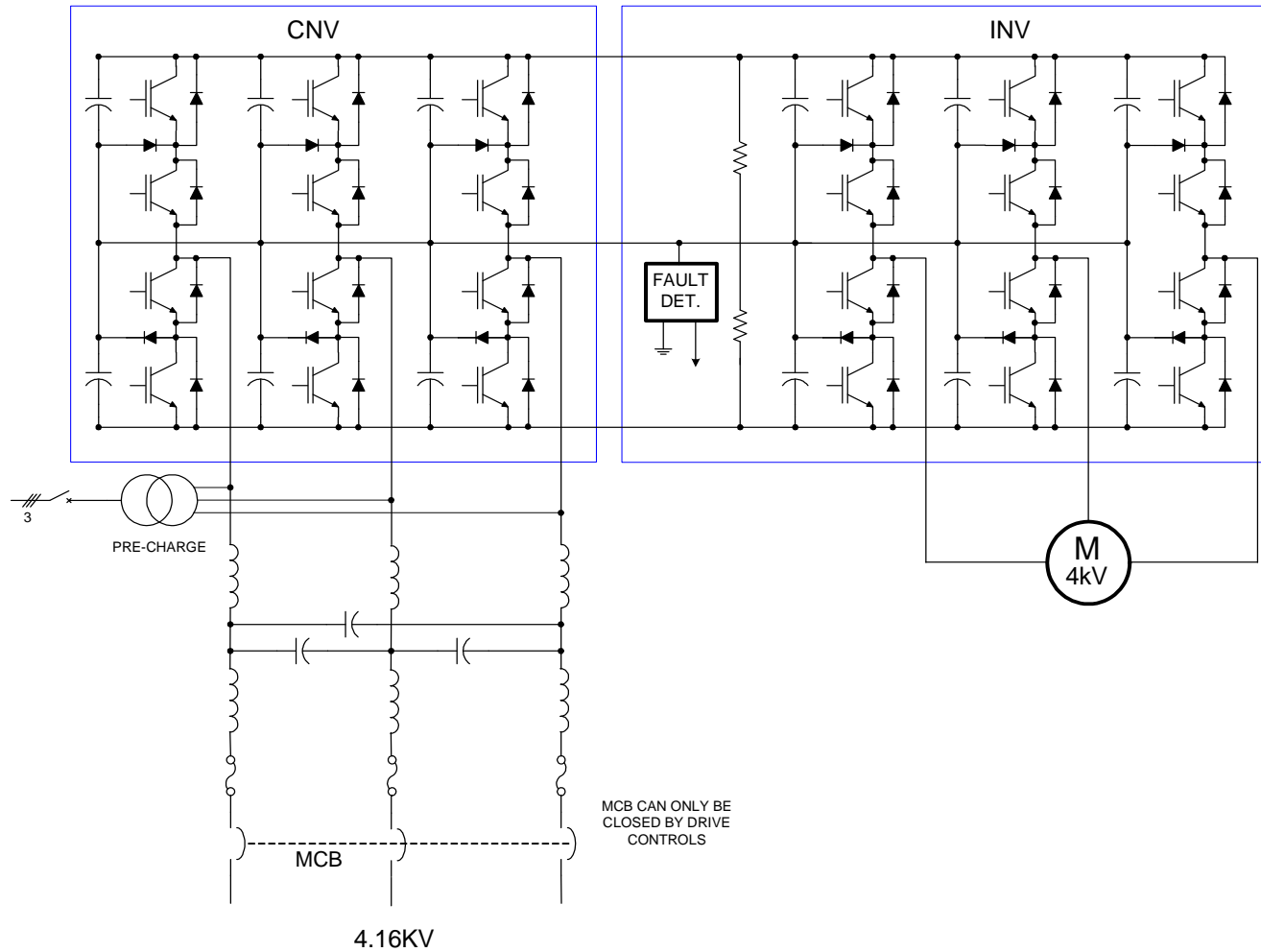

Figure 5. Converteam HTLC Starter

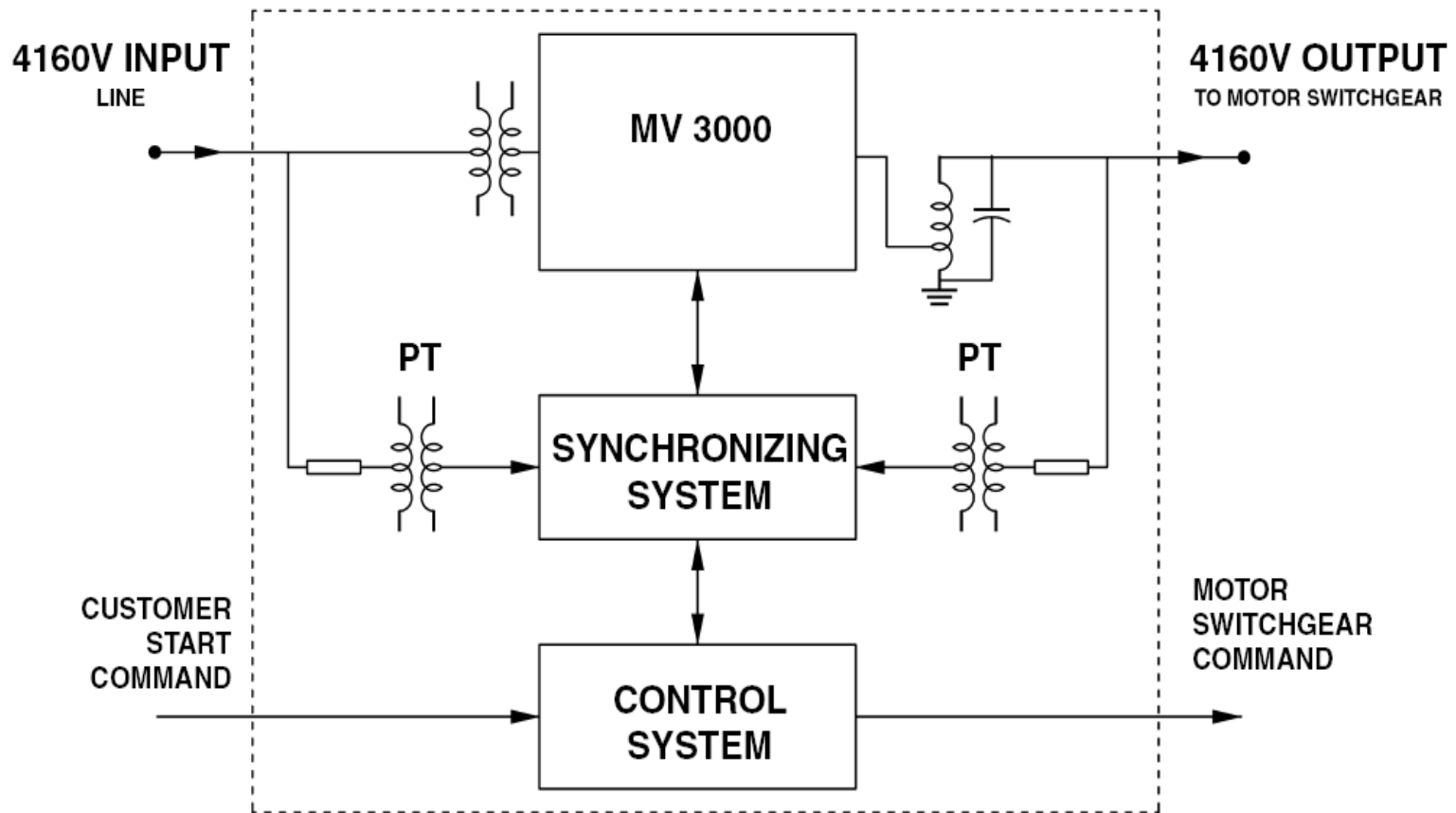
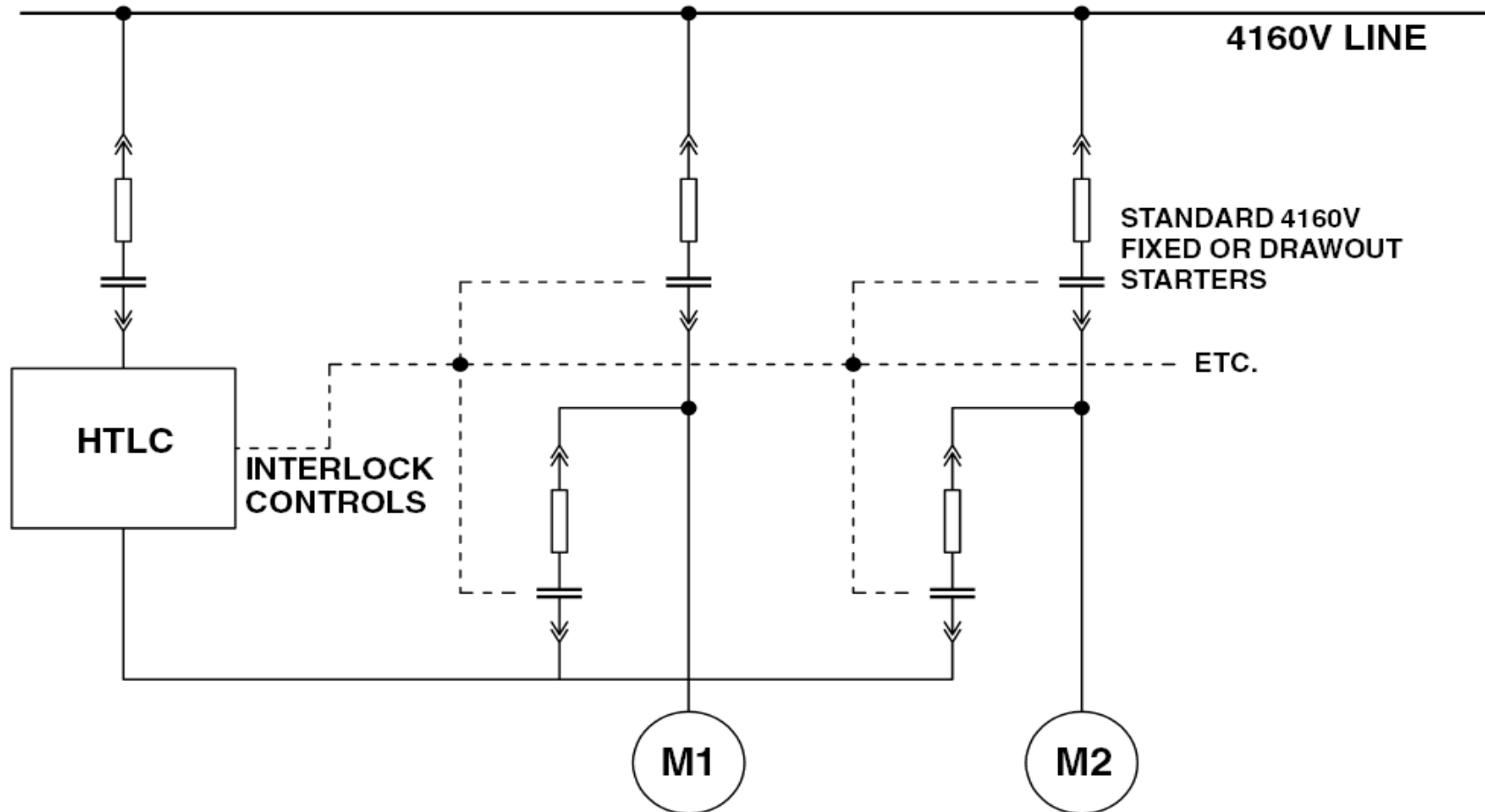
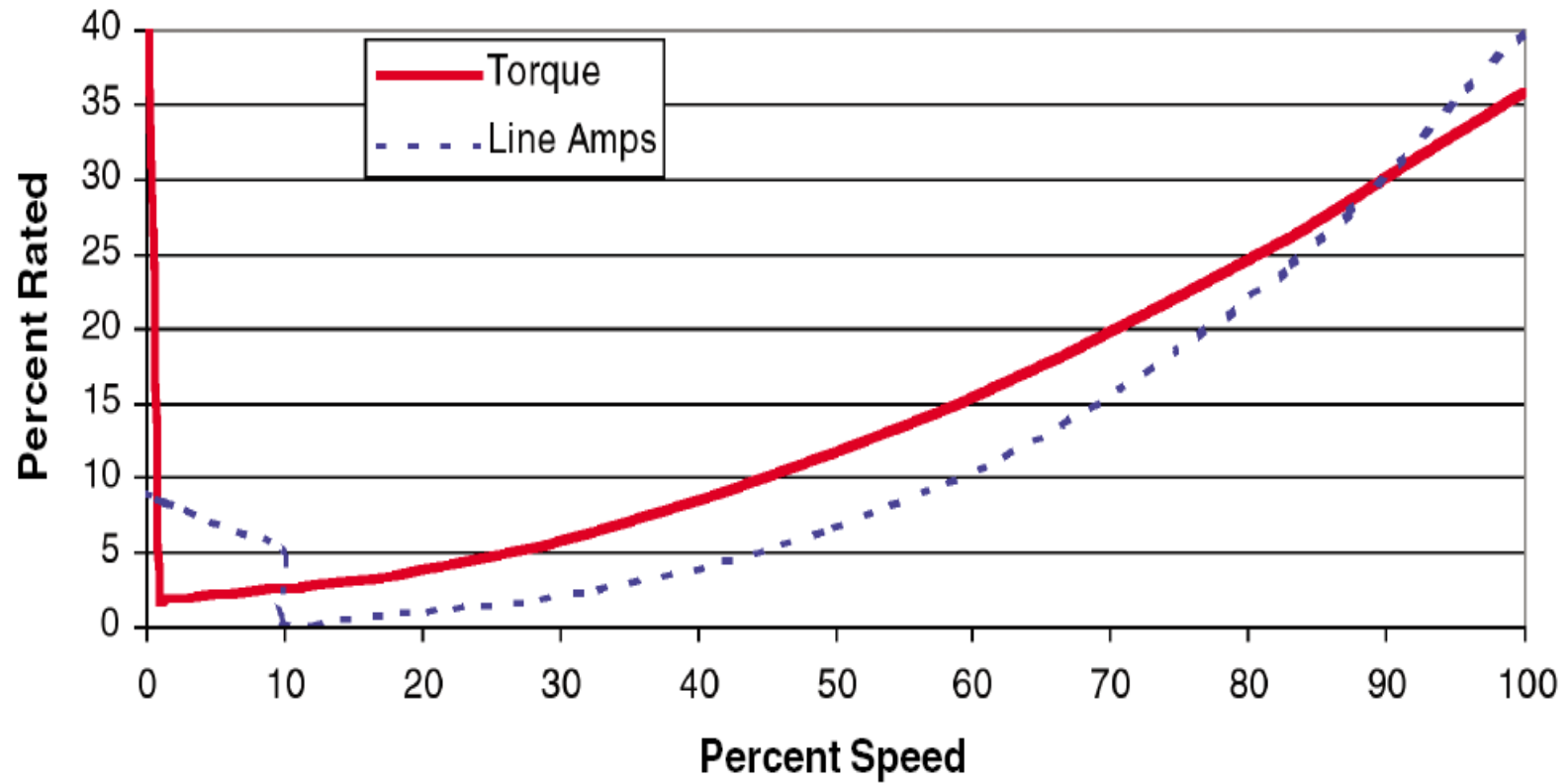

Figure 6. Typical Switchgear for HTLC Starter



**Figure 4. HTLC Compressor Starting**



# Induction motor technology

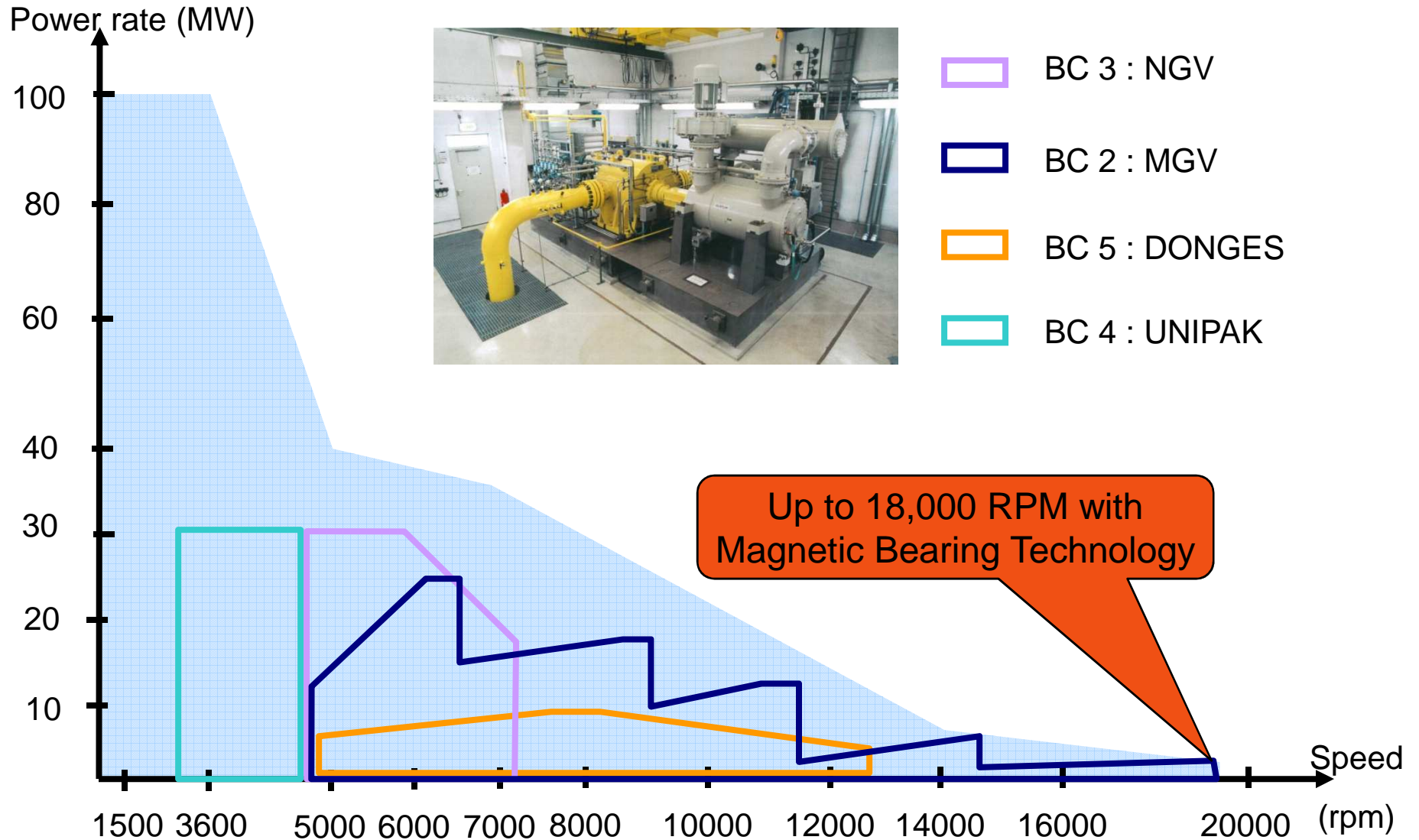

Thank you for your attention

[www.convertteam.com](http://www.convertteam.com)

**CONVERTTEAM**  
THE POWER CONVERSION COMPANY



## Session 5.0

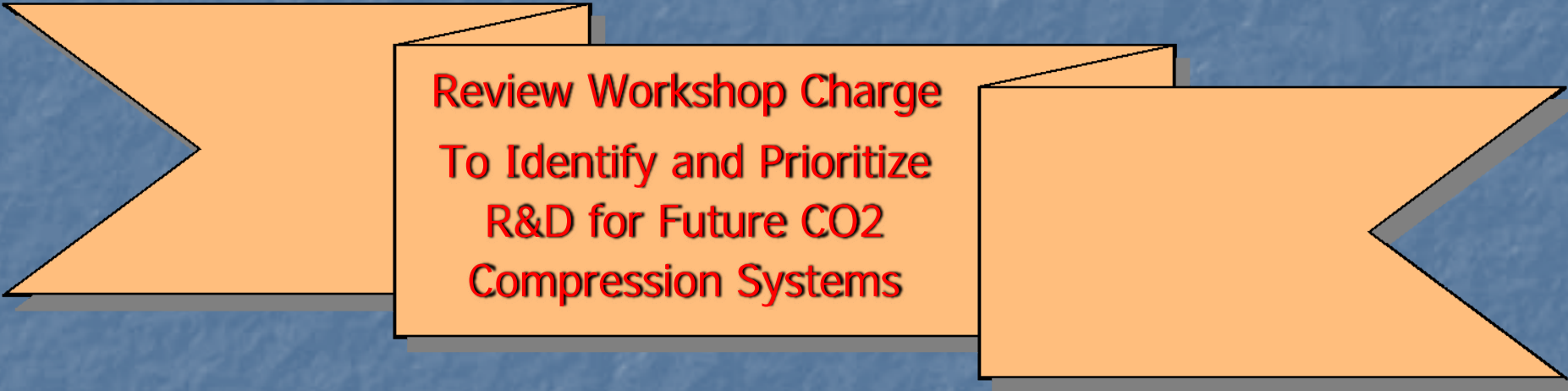

**Review Workshop Charge  
To Identify and Prioritize  
R&D for Future CO<sub>2</sub>  
Compression Systems**

## Session 6.0



**Advanced Compressor  
Machinery Future  
R&D Needs**

## Session 6.1

**R&D Needs for Advanced  
Compression of Large  
Volumes of Carbon Dioxide  
Moore**



# Research and Development Needs for Advanced Compression of Large Volumes of Carbon Dioxide

**J. Jeffrey Moore, Ph.D.**  
**Mathew Blieske**  
**Hector Delgado**  
**Andrew Lerche**  
Southwest Research Institute  
San Antonio, TX

**Charles Alsup**  
National Energy Technology Laboratory  
Morgantown WV

**Jorge Pacheco, Ph.D.**  
Dresser-Rand

**Mathew Bough**  
**David Byard**  
BP

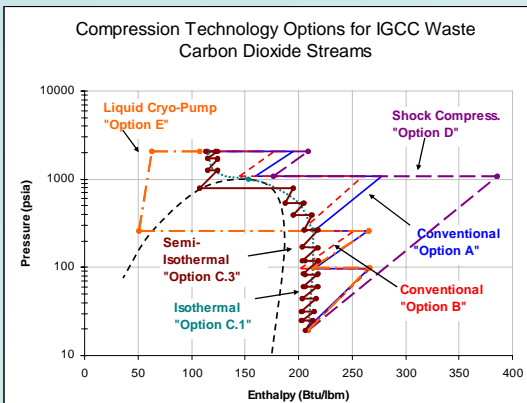

**Workshop on Future Large CO<sub>2</sub> Compression Systems**  
Sponsored by  
DOE Office of Clean Energy Systems,  
EPRI, and NIST

**March 30-31, 2009**

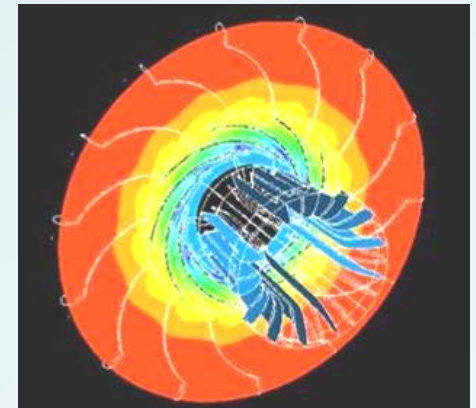



# Who Is SOUTHWEST RESEARCH INSTITUTE?



## 11 Divisions

- Engine Emissions
- Fuels & Lubricants
- Automation
- Aerospace Electronics
- Space Science
- Nuclear Waste
- Applied Physics
- Training, Simulation
- Chemistry
- Electronics
- Mechanical & Materials Engineering

- 1200 Acres
- 2 million Ft<sup>2</sup>

- 3300 Employees
- 1300 Engineers
- 170 Buildings



# CO<sub>2</sub> R&D Needs

- Reduce the power penalty associated with CCS
- Compression must be integrated and optimized with various capture schemes
  - Amine solvents
  - Chemical looping
  - Membranes
- Reliability of the equipment important
- Beneficial to leverage existing compression technology
- Equation of state near critical point and with mixtures



# Motivation of Current Project

- CO<sub>2</sub> capture has a significant compression penalty
- Final pressure around 1,500 to 2,200 psia for pipeline transport or re-injection.
- Based on a 400 MW plant, the typical flow rate is ~600,000 to 700,000 lbm/hr.
- Project goal: Double-digit reduction of compression power for CO<sub>2</sub> capture
- Many thermodynamic processes studied.
- Several challenges with the application discussed.
- Research applicable to PC, Oxy-Fuel, IGCC & NGCC



# General Comments

- The type of compressor is highly dependent on the starting pressure
  - Approximately 20 to 500 psia for CO<sub>2</sub> scrubbing of the fuel stream (for IGCC).
  - Approximately 15 psia from PC and Oxy-Fuel.
- High pressure ratio results in significant heat of compression.
- Various compressor types have been considered.
- Isothermal compression - one concept considered to reduce the power of compression.
- Liquefaction of CO<sub>2</sub> has also been studied.





# IGCC Process with Carbon Capture

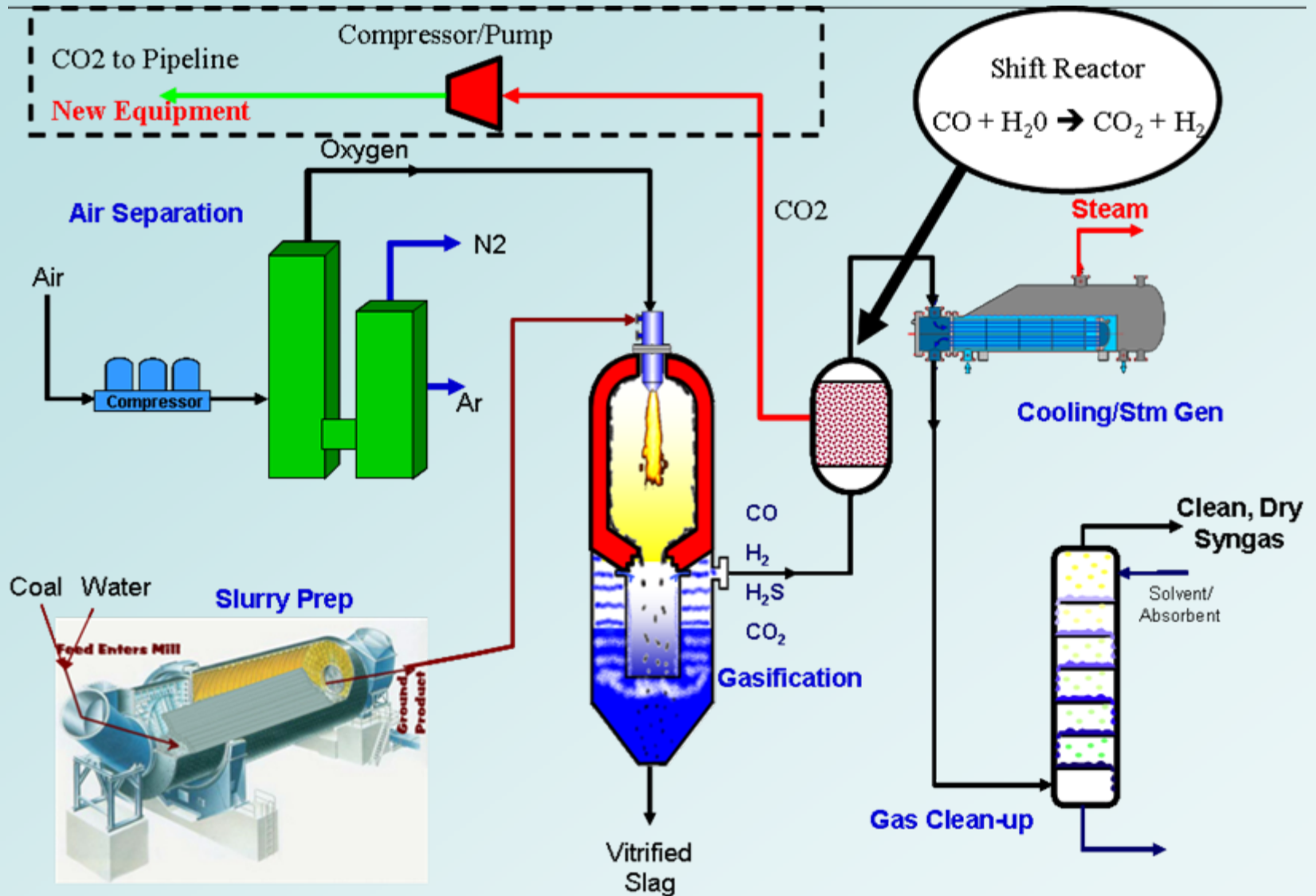



# DOE PC Reference Case

- Only CO<sub>2</sub> stream considered

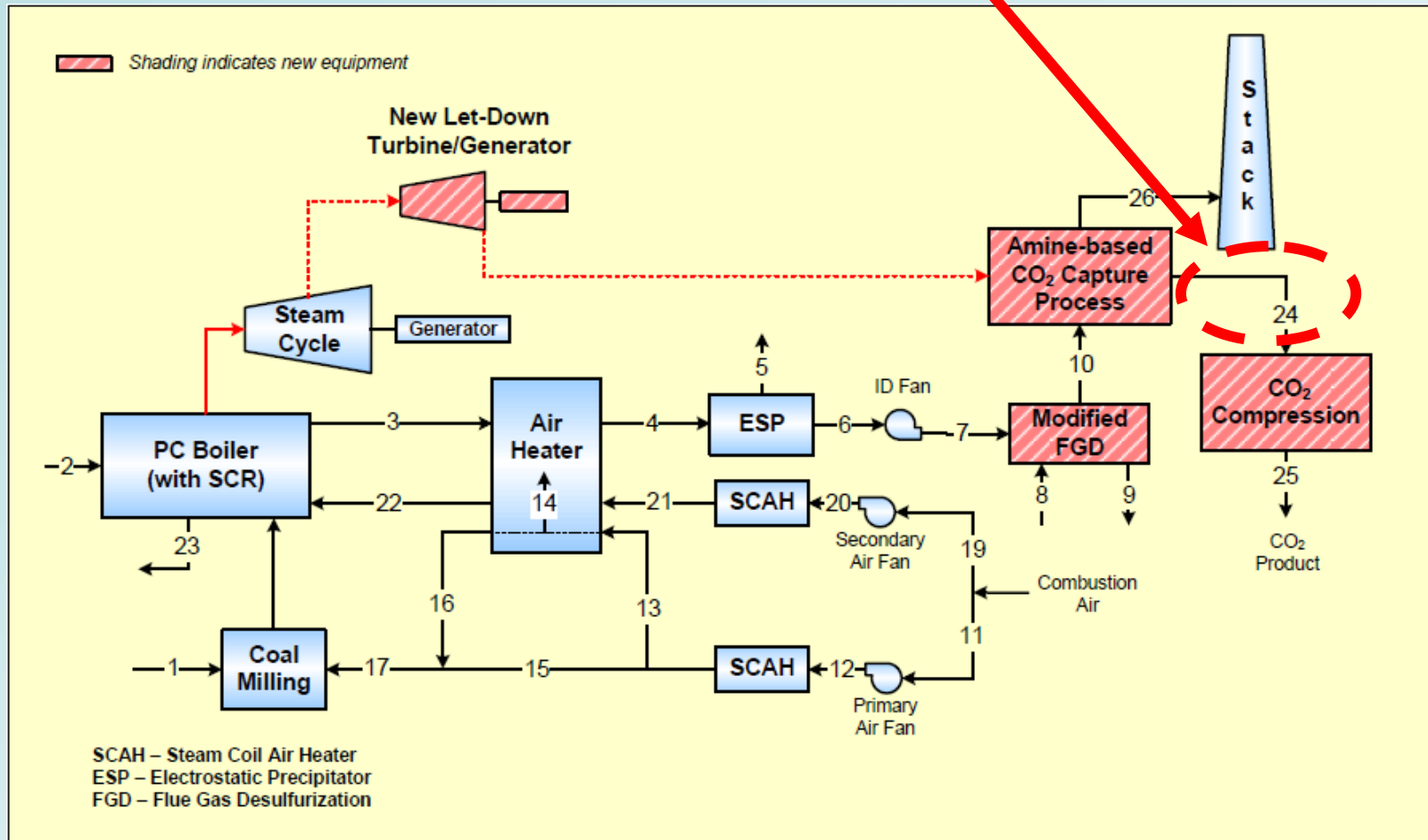



# Challenges: Volume Reduction

Mass Flow Rate = 700,000 lbm / hr = 144.89 MMSCFD

Pressure (psia)	Volume Flow (acfm)
14.7	100,595.2
150	9,858.3
300	4,929.2
450	3,286.1
600	2,464.6
1,000	1,478.8
1,500	985.8

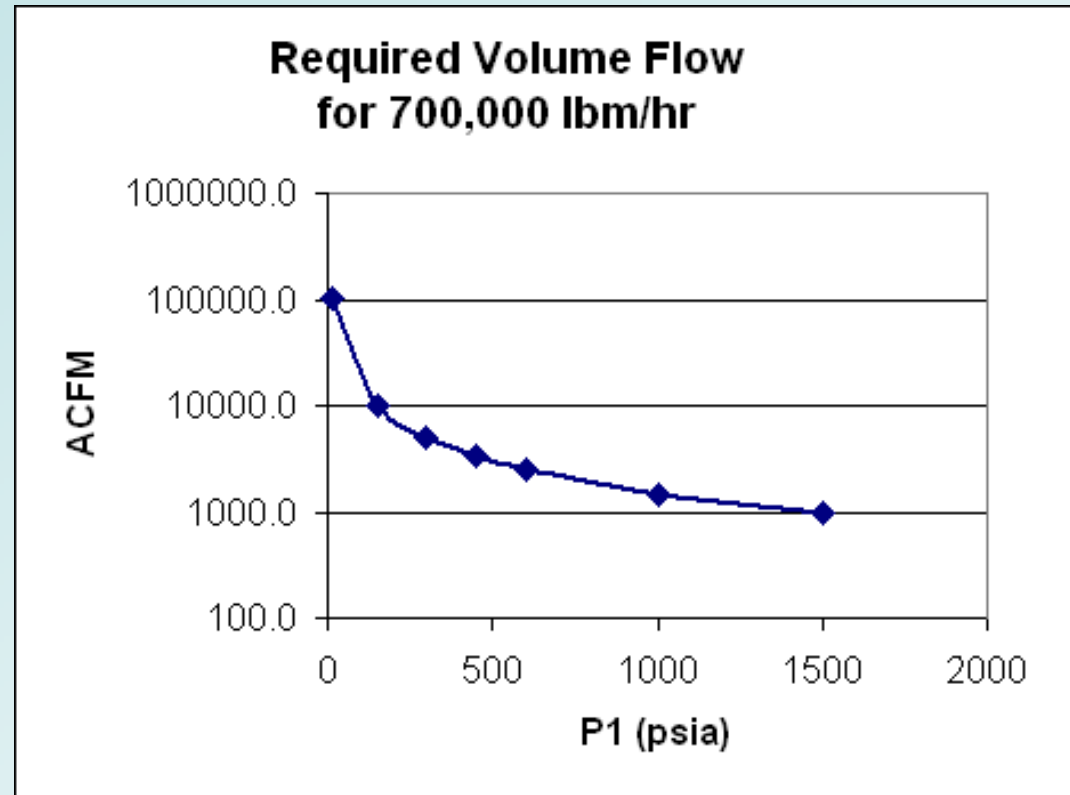

**High volume flow reduction adds to challenge in compressor selection**



# Challenges: Multiple Streams

- Uncompressed CO<sub>2</sub> streams in a typical IGCC plant with a physical absorption separation method using Selexol solvent.

<b>CO<sub>2</sub> Gas Streams</b>	<b>LP</b>	<b>MP</b>	<b>HP 1</b>	<b>HP 2</b>
Pressure (psia)	21.9	160.0	250.0	299.0
Temperature (°F)	51.0	68.0	90.0	75.0
Density (lbm/ft <sup>3</sup> )	0.177	1.3	1.87	2.088
Flow Rate (acfm)	33,257	2,158	3,374	1,073

Higher pressure separation streams help reduce volume reduction. This allows a more uniform frame size in compressor selection.



# Challenges: Wide flow range required

- CO<sub>2</sub> mass flow proportional to power plant Output (e.g. 50-100%)

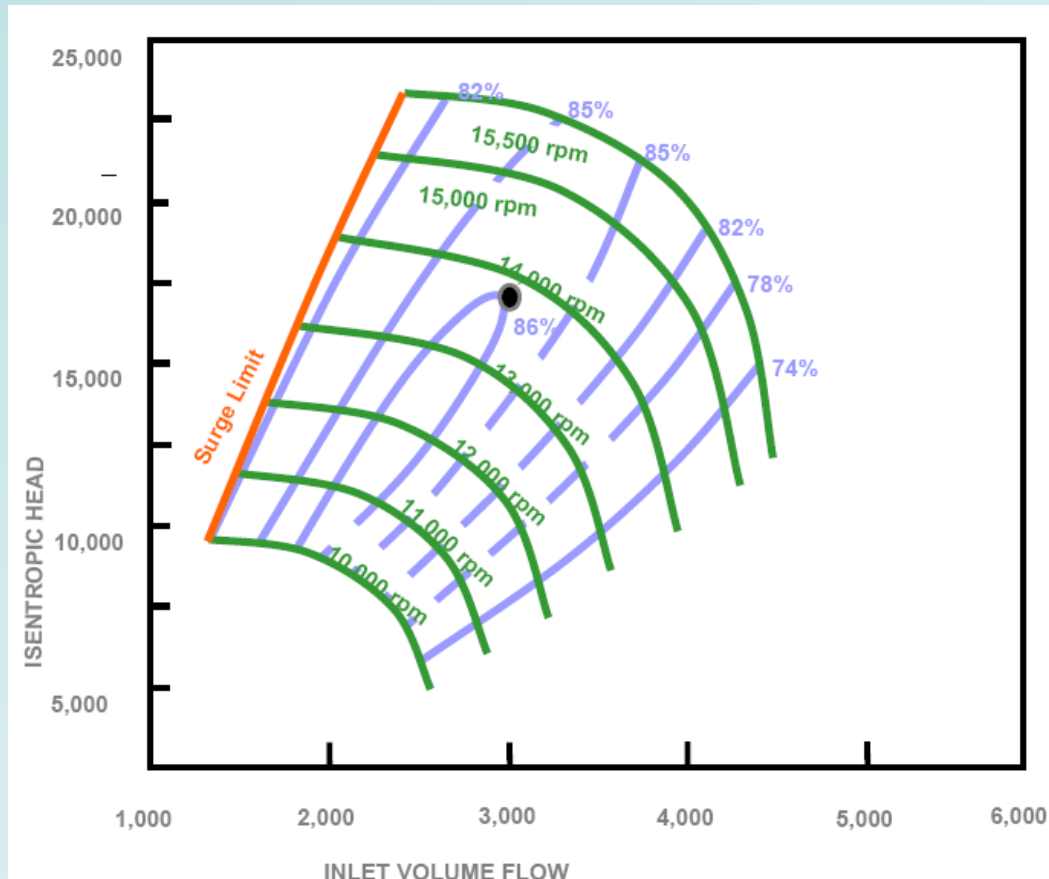



# Challenges: High Mole Weight

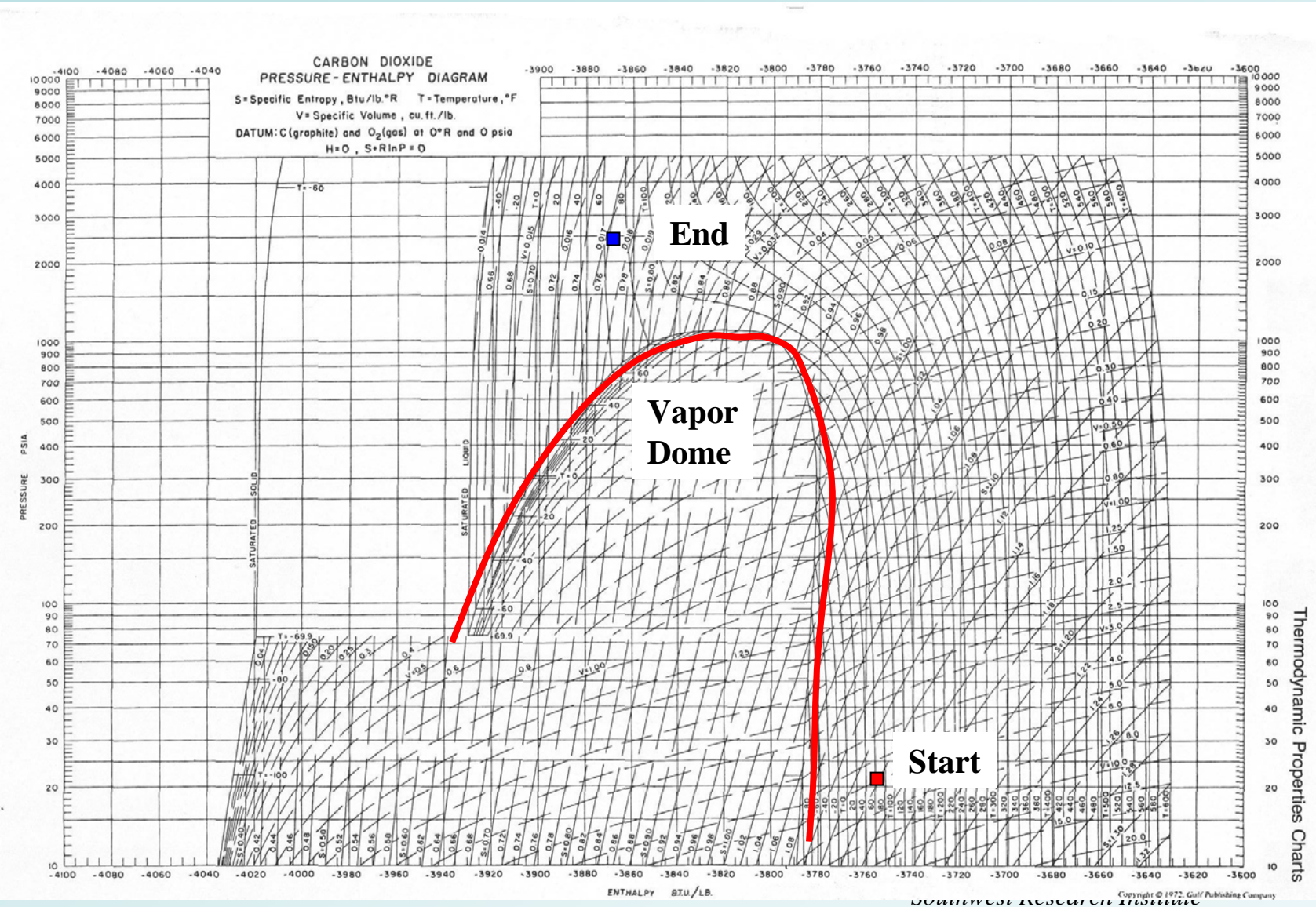



# Challenges: High Reliability

## Integrally Geared Isothermal Compressor

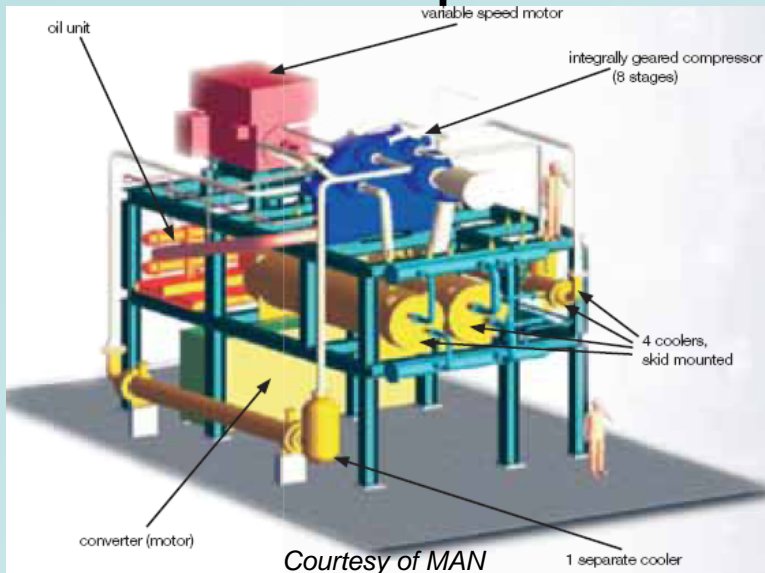

- Integrally geared can achieve near isothermal compression
- Can contain up to 12 bearings, 10 gas seals plus gearbox
- Typically driven by electric motor
- Impellers spin at different rates
  - Maintain optimum flow coef.

## Single-Shaft Multi-stage Centrifugal Compressor

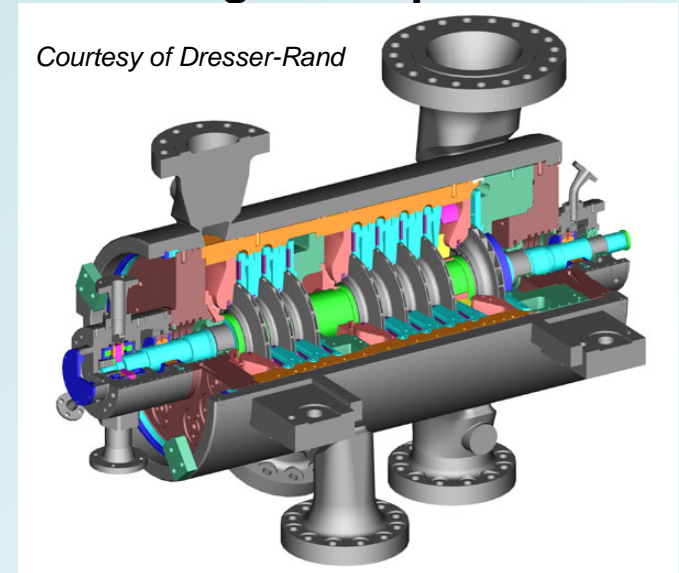

- Multi-stage centrifugal proven reliable and used in many critical service applications currently (oil refining, LNG production, etc.)
- Fewer bearings and seals
  - (4 brgs & seals for 2 body train)
- Can be direct driven by steam turbine



# Path Dependent Process Comparison

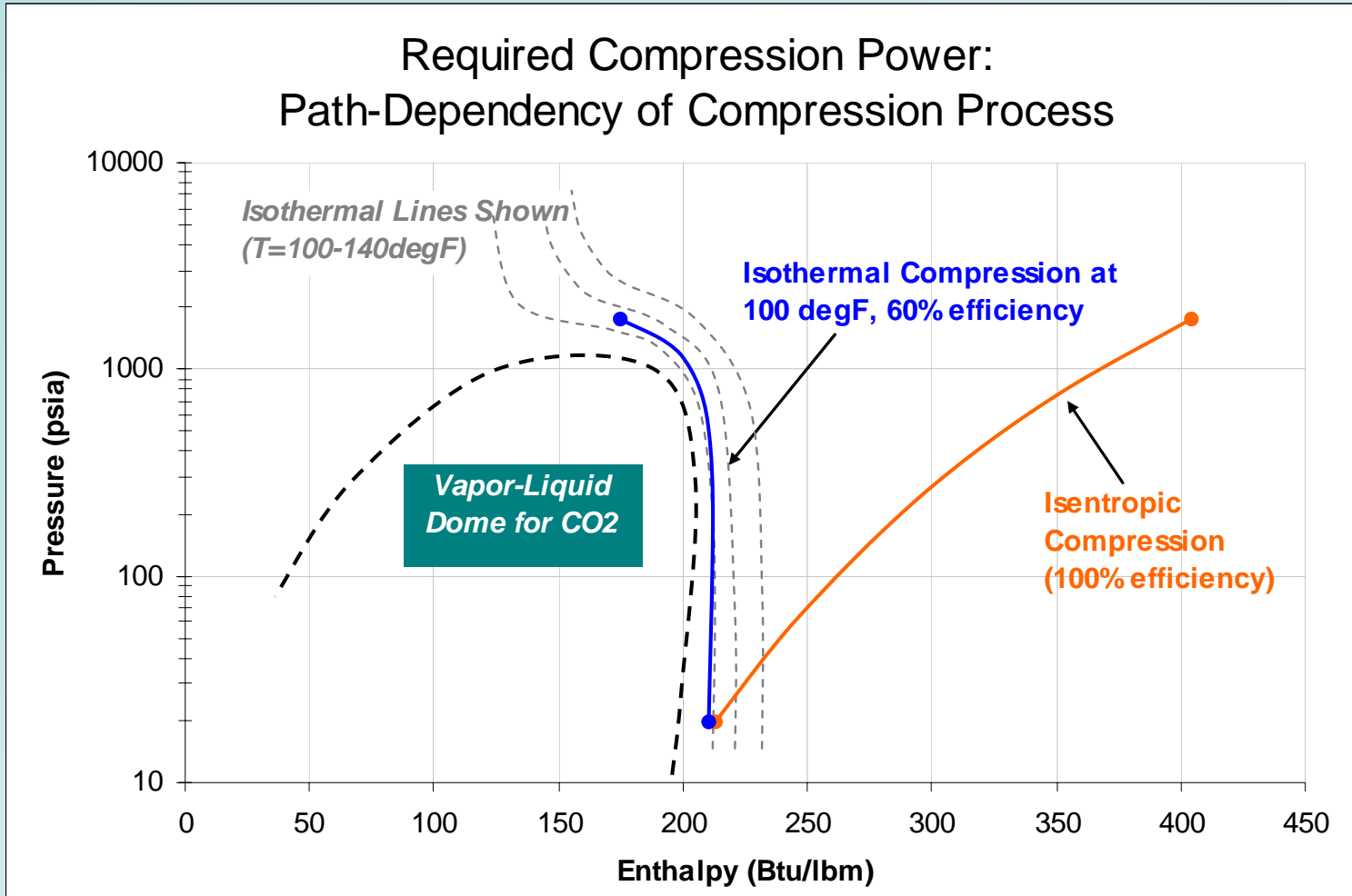

**Comparing a 60% isothermal compressor to a 100% efficient isentropic compressor...Which is better???**





# Isentropic vs. Isothermal Compression

Isentropic Compression Calculations for 20-2200 psia										
P1	P2	T1	T2	h1	h2	rho1 (lbm/ft3)	rho2 (lbm/ft3)	Polytropic Efficiency	W/mdot (Btu/lbm)	BHP
20	220	70	415	216.05	290.92	0.156	1.0446	0.99	74.870	5879.6
220	2200	415	875	290.92	404.12	1.0446	6.6665	1.00	113.200	8889.6
									Mdot (lb/hr)=	200000
									Mdot (lb/hr)=	200000
									Total BHP =	14769.2

Isothermal Compression Calculations at 100 degF and 60% efficiency										
Low Pressure									Mdot (lb/hr)=	200000
P1	P2	To	P2/P1	In (P2/P1)	Ideal W/mdot (Btu/lbm)	Assumed Efficiency	Actual W/mdot (Btu/lbm)	BHP		
20	100	100	5.00	1.61	37.62	0.600	62.705	4924.2		
Side Stream + Medium Pressure									Mdot (lb/hr)=	200000
100	260	100	2.60	0.96	21.28	0.600	35.461	2784.8		
170	260	100	1.53	0.42	9.32	0.600	15.541	1220.4		
High Pressure									Mdot (lb/hr)=	200000
260	600	70	2.31	0.84	16.41	0.600	27.344	2147.3		
600	1097	70	1.83	0.60	6.50	0.600	10.841	851.4		
1097	2200	70	2.01	0.70	3.92	0.600	6.536	513.3		
									Total BHP =	12441.4

Isentropic Compression  
(100% efficiency) = 14,769 BHP

Isothermal Compression  
(60% efficiency) = 12,441 BHP

The 60% efficient isothermal compressor is preferred.



# Deviation in Models for CO<sub>2</sub> Mixtures

## Variation in Predicted Gas Density for CO<sub>2</sub> Mixture

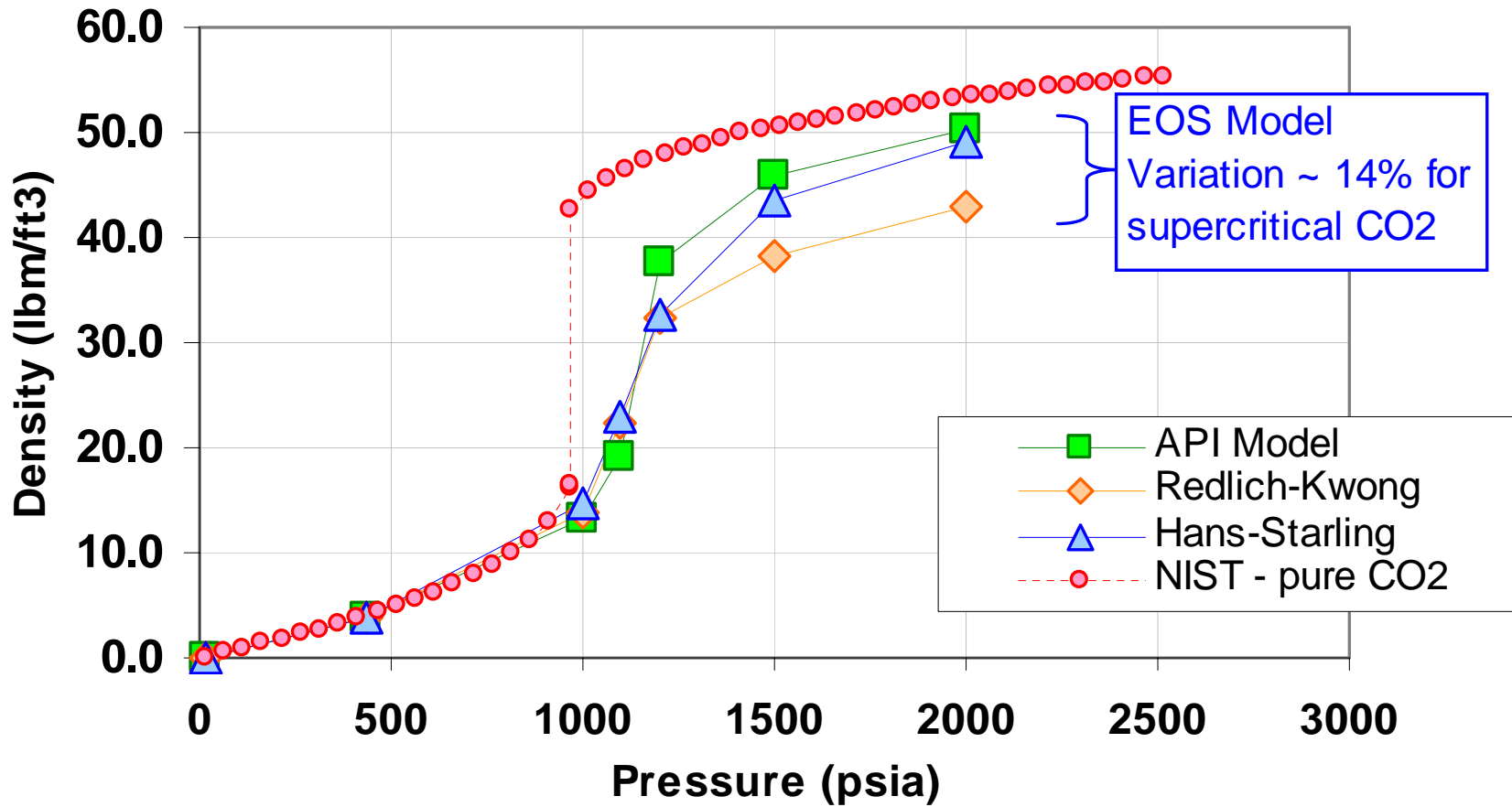



# Deviation in Models for CO<sub>2</sub> Mixtures

## Variation in Predicted SOS for CO<sub>2</sub> Mixture

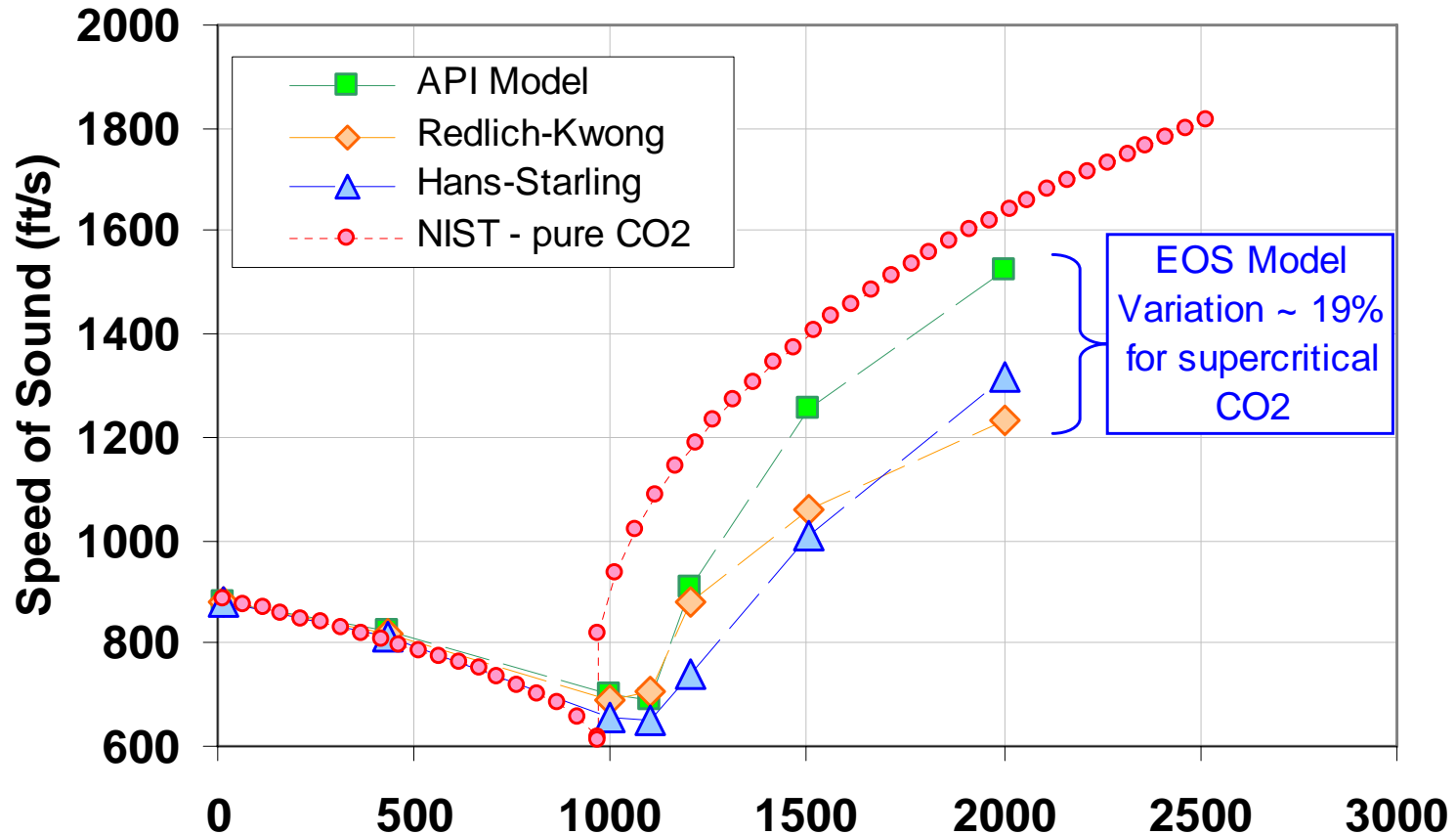

Large differences exist in gas properties predicted by standard equation of state models (API, RKS, HANS) and pure CO<sub>2</sub> correlation models from 1000-2000 psia.



# Gas Properties Testing

- Gas properties testing for acid gas at SwRI
- Molecular weight and speed of sound





# Back to Current Project



# Project Overview

- Phase I (Completed)
  - Perform thermodynamic study to identify optimal compression schemes
- Phase II (Complete in 2010)
  - Pilot testing of two concepts:
    - Isothermal compression
    - Liquid CO<sub>2</sub> pumping
  - Total Project Amount \$1.5 million



# D-R Selection Using Conventional Centrifugal Compressors (Baseline)

- Requires two parallel trains
- Intercooling between each section

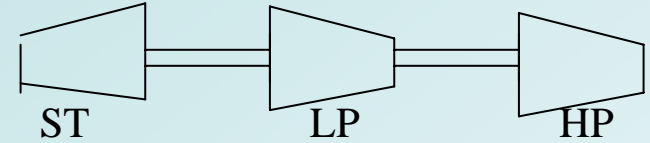

OPERATING CONDITIONS					
(ALL DATA ON PER UNIT BASIS)					
			Base		
		D18R7B		D16R9B	
SEC #1	SS In	SEC #2	SEC #1	SEC #2	
LP	MP		Blend		
176,649	168,445	260,872	517,475	517,475	
21.90	170.0	96.58	248.0	1,087	
51.00	68.00	90.21	100.00	100.0	
43.88	43.13	43.63	41.61	41.61	
16,634		5,908	4,694	745.0	
106.6		258.0	1,097	2,215	
299.3		258.1	369.8	231.4	
1.271		1.272	1.274	1.230	
0.9910		0.9685	0.9334	0.6919	
3,684		3,656	12,126	5,180	
		5,166			

**Total Power = 49,292 HP (37 MW, 5.2% of 700 MW Output)**



# Summary of Thermodynamic Analysis

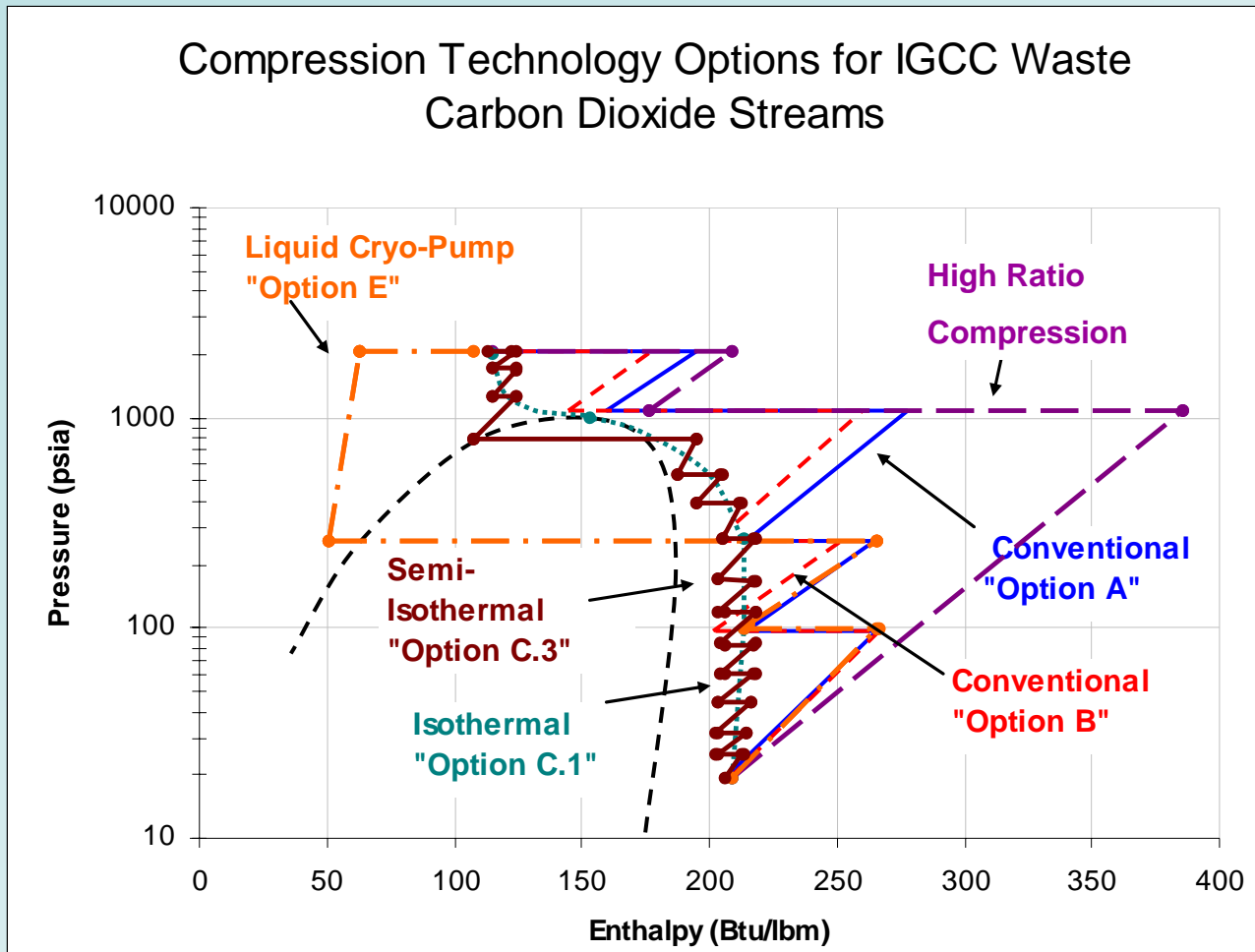





# Proposed Solution for Optimal Efficiency

## Compression Technology Options for IGCC Waste Carbon Dioxide Streams

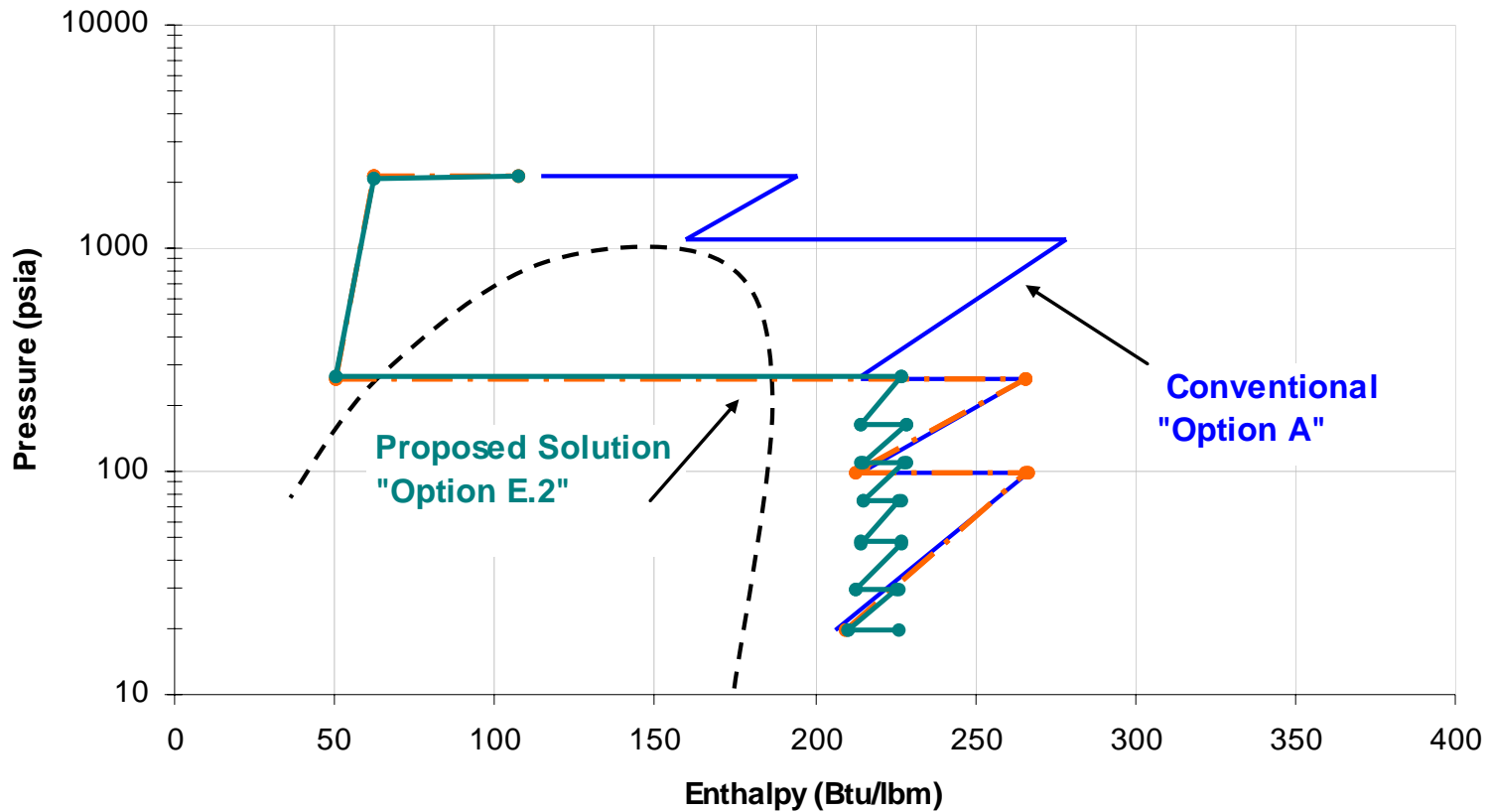

Optimal solution combines inter-stage cooling and a liquefaction approach.



# Summary of Thermodynamic Analysis

Option	Compression Technology	Power Requirements	% Diff from Option A	Cooling Technology
<b>A</b>	Conventional Dresser-Rand Centrifugal 10-stage Compression	23,251 BHP	0.00%	Air-cool streams between separate stages
<b>B</b>	Conventional Dresser-Rand Centrifugal 10-stage Compression with additional cooling	21,522 BHP	-7.44%	Air-cool streams between separate stages using ASU cool N2 stream
<b>C.1</b>	Isothermal compression at 70 degF and 80% efficiency	14,840 BHP	-36.17%	Tc = 70 degF inlet temp throughout
<b>C.4</b>	Semi-isothermal compression at 70 degF, Pressure Ratio ~ 1.55	17,025 BHP (Required Cooling Power TBD)	-26.78%	Tc = 70degF in between each stage.
<b>C.7</b>	Semi-isothermal compression at 100 degF, Pressure Ratio ~ 1.55	17,979 BHP (Required Cooling Power TBD)	-22.67%	Tc = 100degF in between each stage.



# Summary of Thermodynamic Analysis

Option	Compression Technology	Power Requirements	% Diff from Option A	Cooling Technology
D.3	High ratio compression at 90% efficiency - no inter-stage cooling	34,192 BHP	47.06%	Air cool at 2215 psia only
D.4	High ratio compression at 90% efficiency - intercooling on final compression stage	24,730 BHP	6.36%	Air cool at 220 and 2215 psia
E.1	Centrifugal compression to 250 psia, Liquid cryo-pump from 250-2215 psia	16,198 BHP (Includes 7,814 BHP for Refrigeration) <sup>1</sup>	-30.33%	Air cool up to 250 psia, Refrigeration to reduce CO2 to -25degF to liquify
E.2	Centrifugal compression to 250 psia with semi-isothermal cooling at 100 degF, Liquid cryo-pump from 250-2215 psia	15,145 BHP (Includes 7,814 BHP for Refrigeration) <sup>1</sup>	-34.86%	Air cool up to 250 psia between centrifugal stages, Refrigeration to reduce CO2 to -25degF to liquify

Note: Heat recovery not accounted for.



# Compression Power for PC Plant

## Isothermal Compression

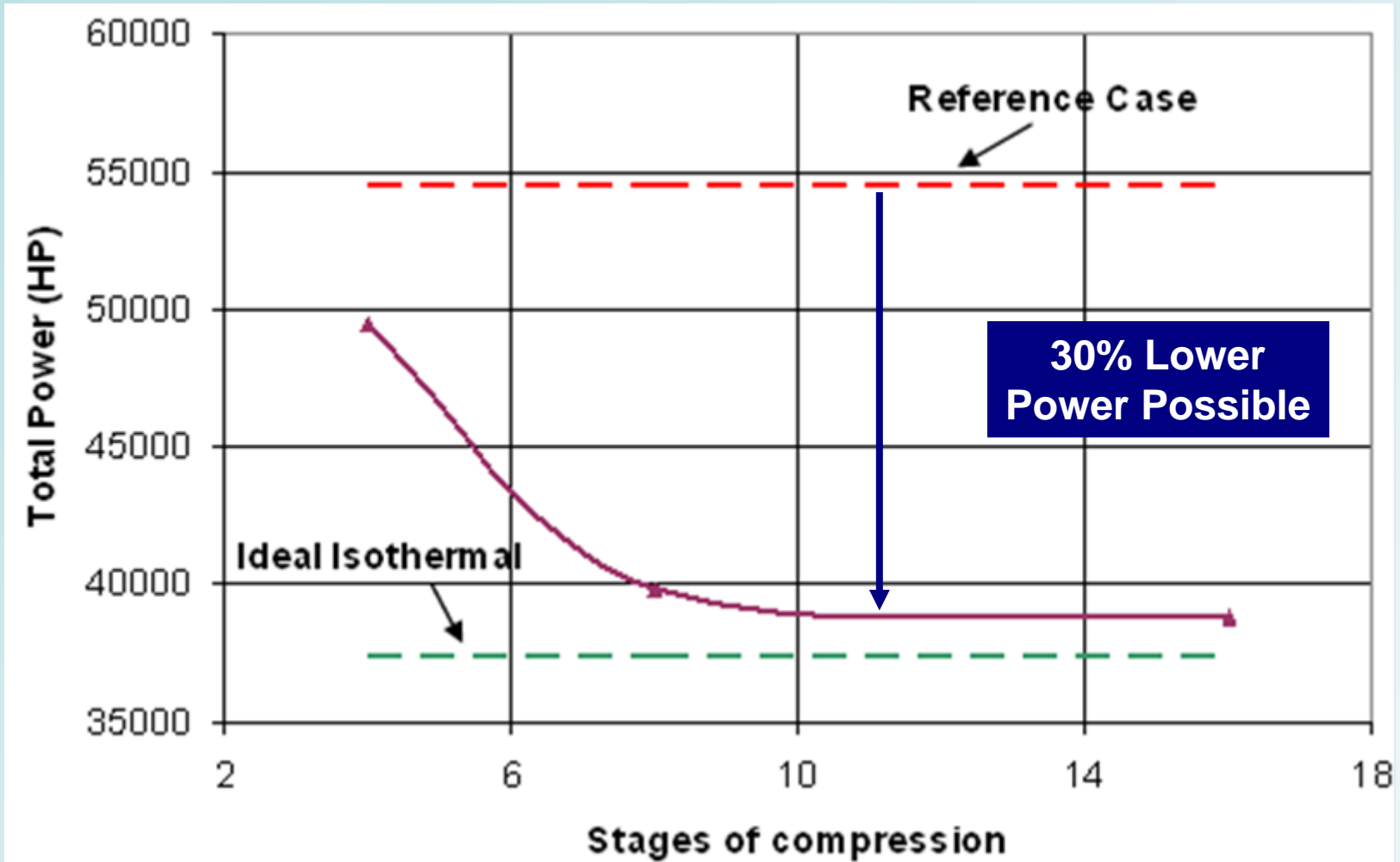



# Compression Power for PC Plant

## Liquefaction/Pumping Compression

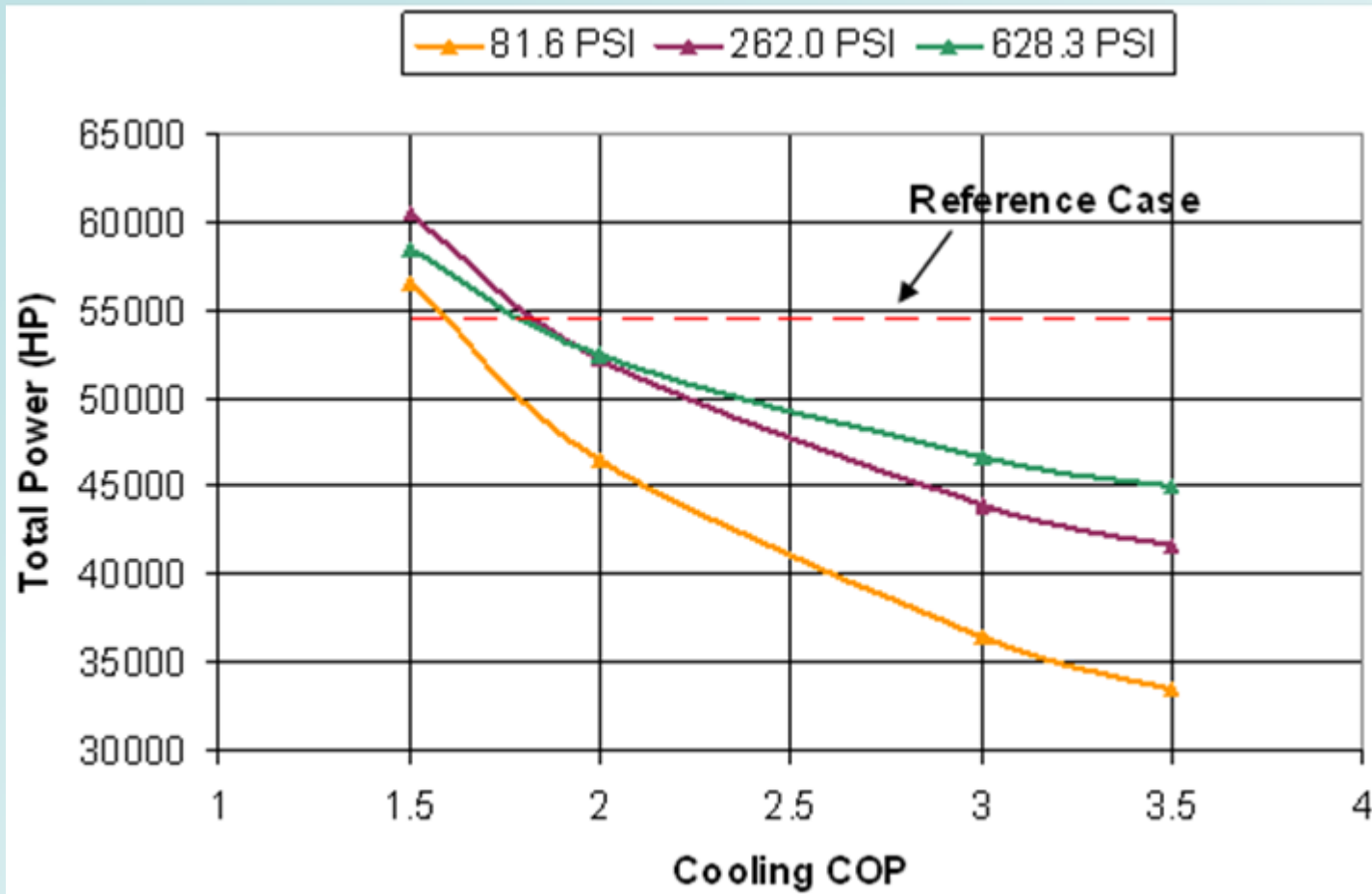



# Project Goals

- Develop internally cooled compressor stage that:
  - Provides performance of an integrally geared compressor
  - Has the reliability of a in-line centrifugal compressor
  - Reduces the overall footprint of the package
  - Has less pressure drop than a external intercooler
- Perform qualification testing of a refrigerated liquid CO<sub>2</sub> pump



# Phase 2 Project Plan

- Experimentally validate thermodynamic predictions.
- Two test programs envisaged:
  - Liquid CO<sub>2</sub> pumping loop
  - Closed-loop CO<sub>2</sub> compressor test with internal cooling
- Power savings will be quantified in both tests.



# Liquid CO<sub>2</sub> Pumping Loop Testing

- Testing will measure pump efficiency
- Validate pump design
- Measure NPSH requirements looking for signs of cavitation
- Investigate gas entrainment effects
- Cryostar will supply the pump (250 KW, 100 gpm)

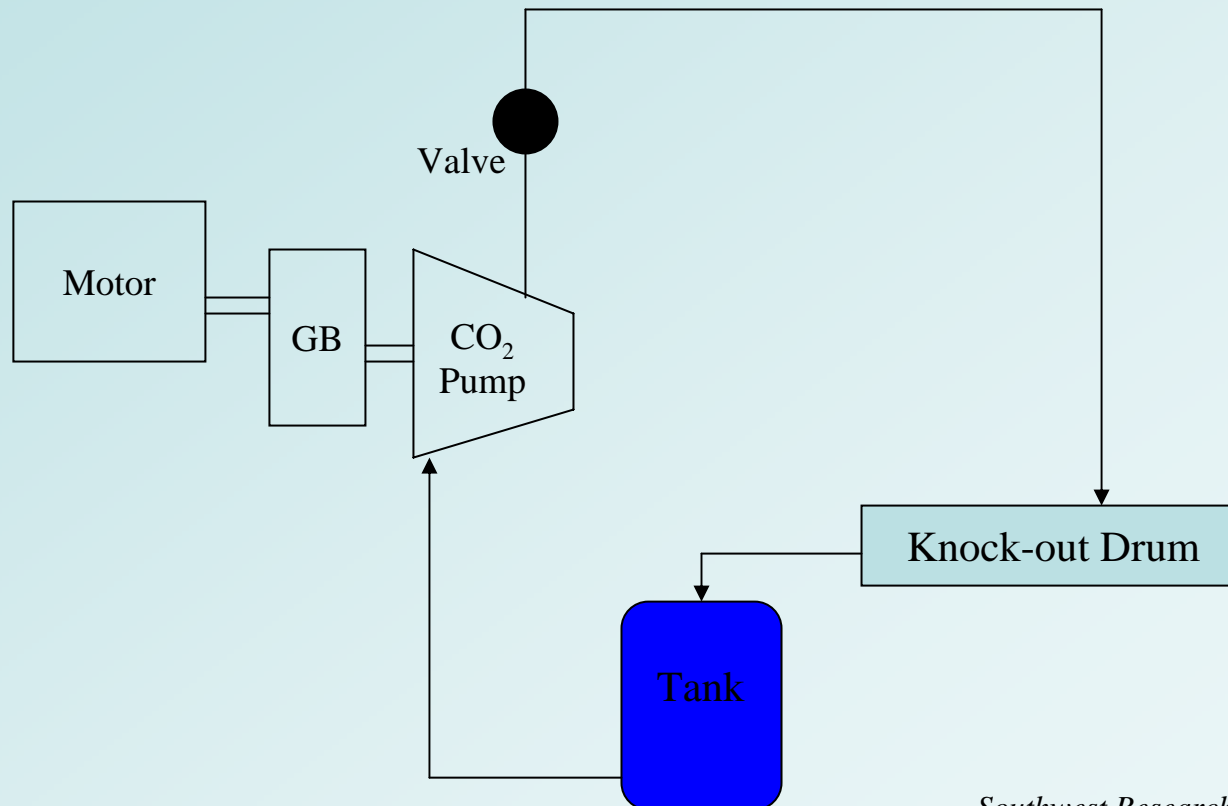





# Liquid CO<sub>2</sub> Loop

- Vessel layout showing elevated reservoir and knock-out drum
- Pump will be mounted at ground level.
- Orifice run will be located between pump and control valve (in supercritical regime)
- Knock-out drum structural support completed

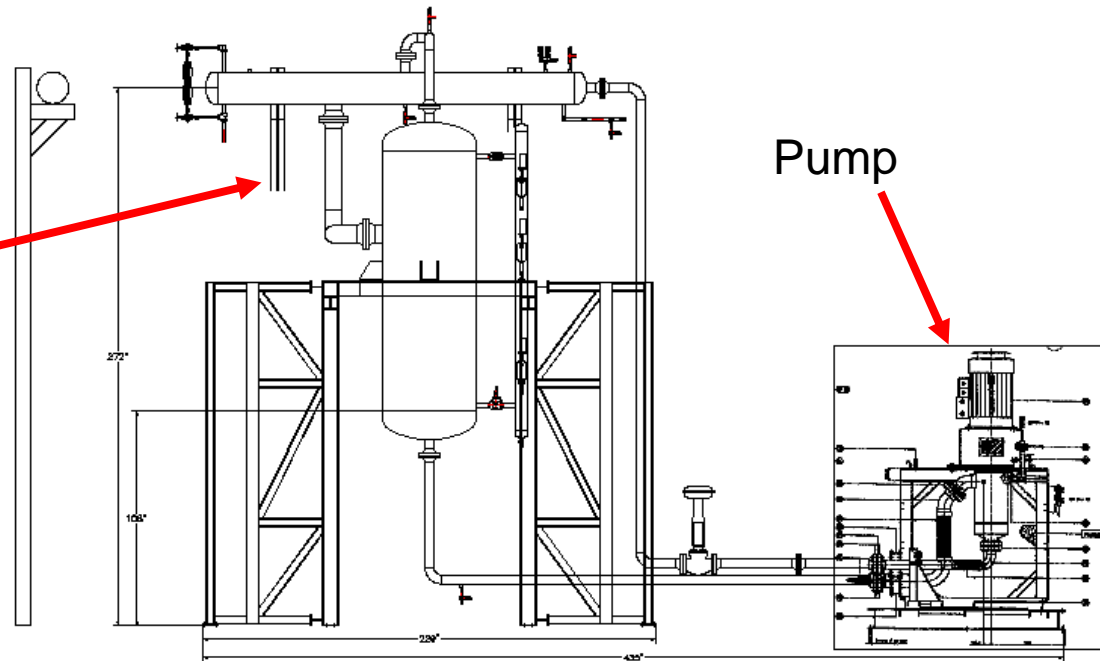
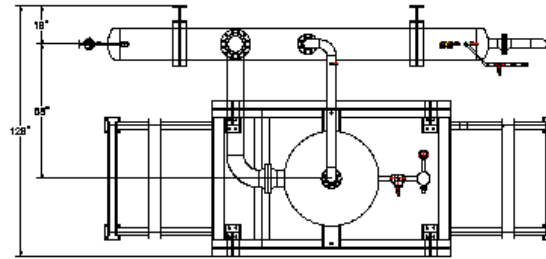



# Internally Cooled Compressor Testing

- Goal: To measure effectiveness of internally cooled diaphragm
- Existing Multi-Stage Test Rig will be utilized using CO<sub>2</sub>
- New impeller and internals will be manufactured and tested
- Diaphragms will contain optimized flow path and cooling jacket design
- Stage performance will be measured (P1, T1, P2, P2, Q)
- Both ambient and chilled cooling water will be employed
- Heat transfer enhancement devices employed

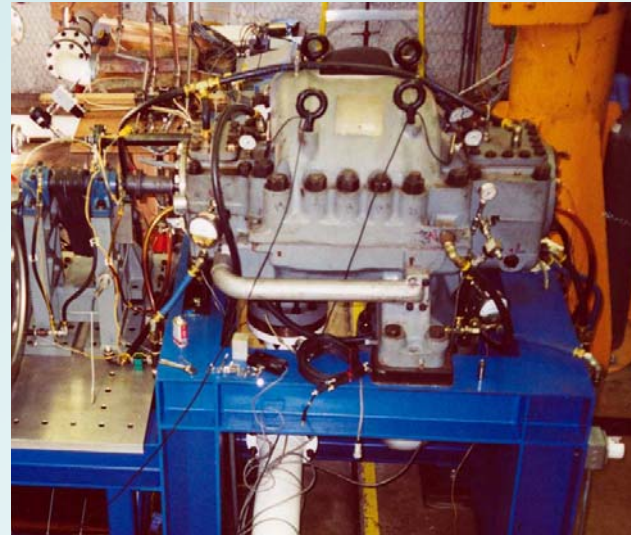
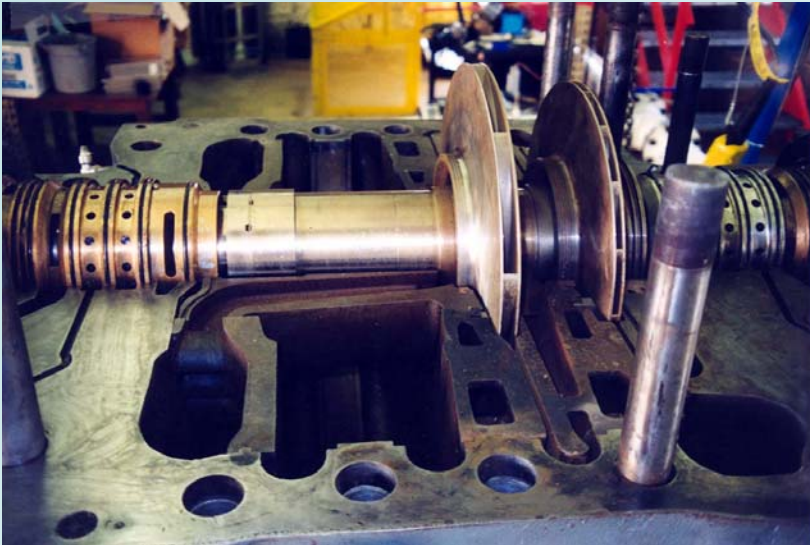



# Program Benefits

- Provide enabling technology to compress CO<sub>2</sub> from a PC, Oxy-Fuel, or IGCC power plant, cost-effectively minimizing the financial impact of CO<sub>2</sub> sequestration.
- This program identified up to 35% power savings over a conventional CO<sub>2</sub> compression solution.
- Technology applicable to all power plant types plants
- The thermodynamic process is more important than compressor efficiency.
- The internally-cooled compressor concept should result in significant capital savings over an integrally geared compressor
- Liquefaction and pumping equipment will add some additional capital expense, but some is offset by lower cost pump compared to high-pressure compressor.
  - A 35% power reduction will save a utility \$4.2 million per year, based on 4¢ / kwh, which will provide a fast return on investment.
- Testing will be complete 1<sup>st</sup> Qtr 2010



# Areas Needing Further Research

- Further work to reduce the power penalty associated with CCS and utilize waste heat
- Compression must be integrated and optimized with various capture schemes
- Perform optimum driver study
  - i.e. gas turbine, motor, steam turbine
- Develop more reliable compression designs
- Perform more gas properties measurements of CO<sub>2</sub> mixtures
- Refine equation of state near critical point and with mixtures
- Perform optimization of pipeline booster stations
  - Station spacing, liquid vs. gas, driver selection
- Improve reliability of recip EOR recycle compressors
  - i.e. valve reliability
  - Variable speed of sound pulsation models (real gas effects)
- Perform further corrosion studies on the effects of moisture on pipeline corrosion



# Questions???

[www.swri.org](http://www.swri.org)

***Dr. J. Jeffrey Moore***  
***Southwest Research Institute***  
***(210) 522-5812***  
***Jeff.Moore@swri.org***

## Session 6.2

**CO<sub>2</sub> Compression for  
Advanced Oxy-Fuel  
Cycles**  
Hustad

# **CO<sub>2</sub> Compression for Advanced Oxy-Fuel Cycles**

## **Workshop on Future Large CO<sub>2</sub> Compression Systems**

Presentation by

Carl-W. Hustad, CEO, CO<sub>2</sub>-Global

At Workshop on Future Large CO<sub>2</sub> Compression Systems

DOE Office of Clean Energy Systems, EPRI, and NIST

March 30<sup>th</sup> and 31<sup>st</sup>, 2009 Gaithersfield, MD



# Complex Interaction of Arenas!

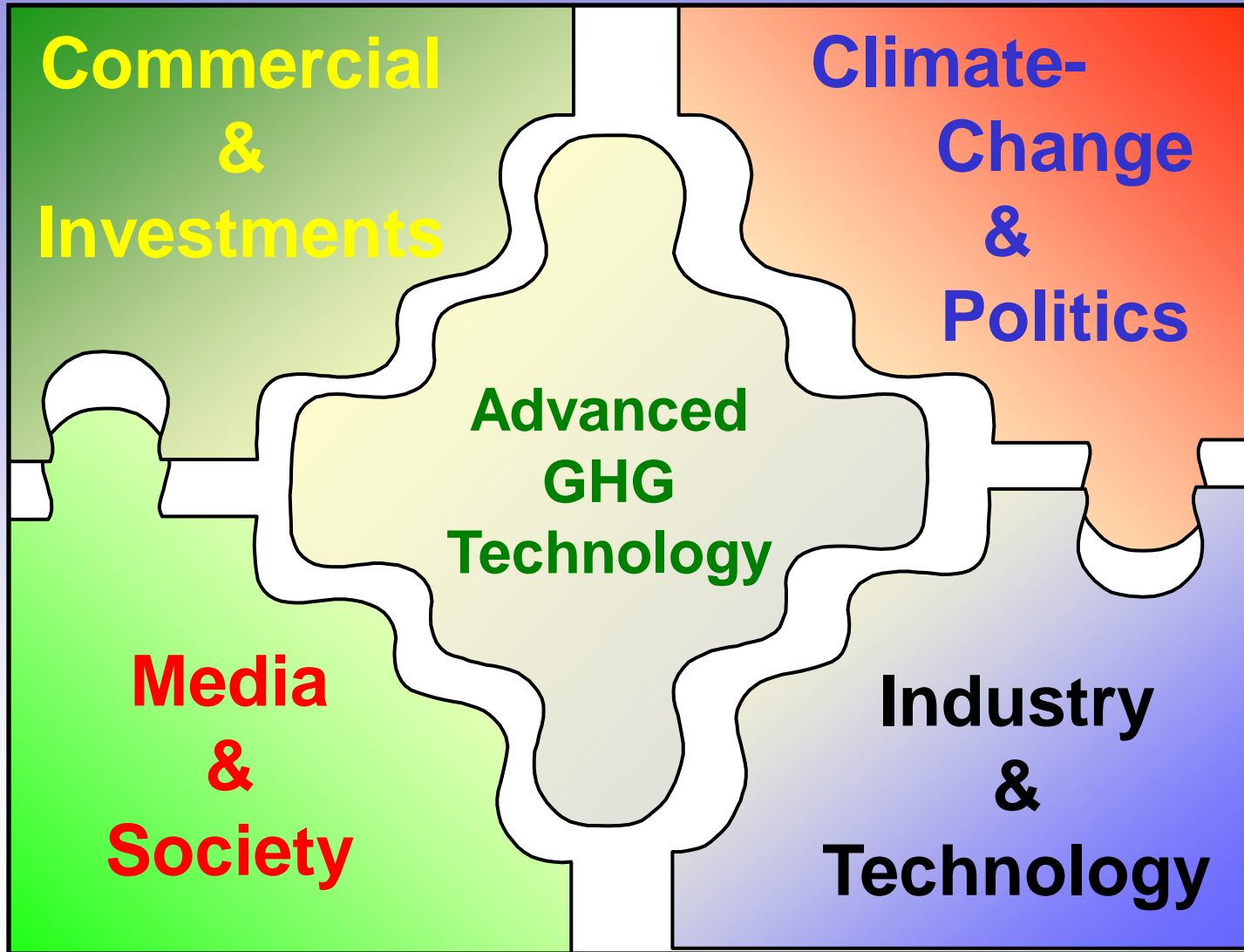



# **Capturing, Managing and Gathering CO2 for EOR Onshore and Offshore: Challenges and Opportunities**

Presented by

Carl-W. Hustad, President & CEO

CO2-Global

At the ACI Optimising EOR Strategy 2009

Park Plaza County Hall, London, UK

On 11th – 12th March 2009



# The United States -- An Established Business: ~220,000 bbls/day in >70 CO2-floods

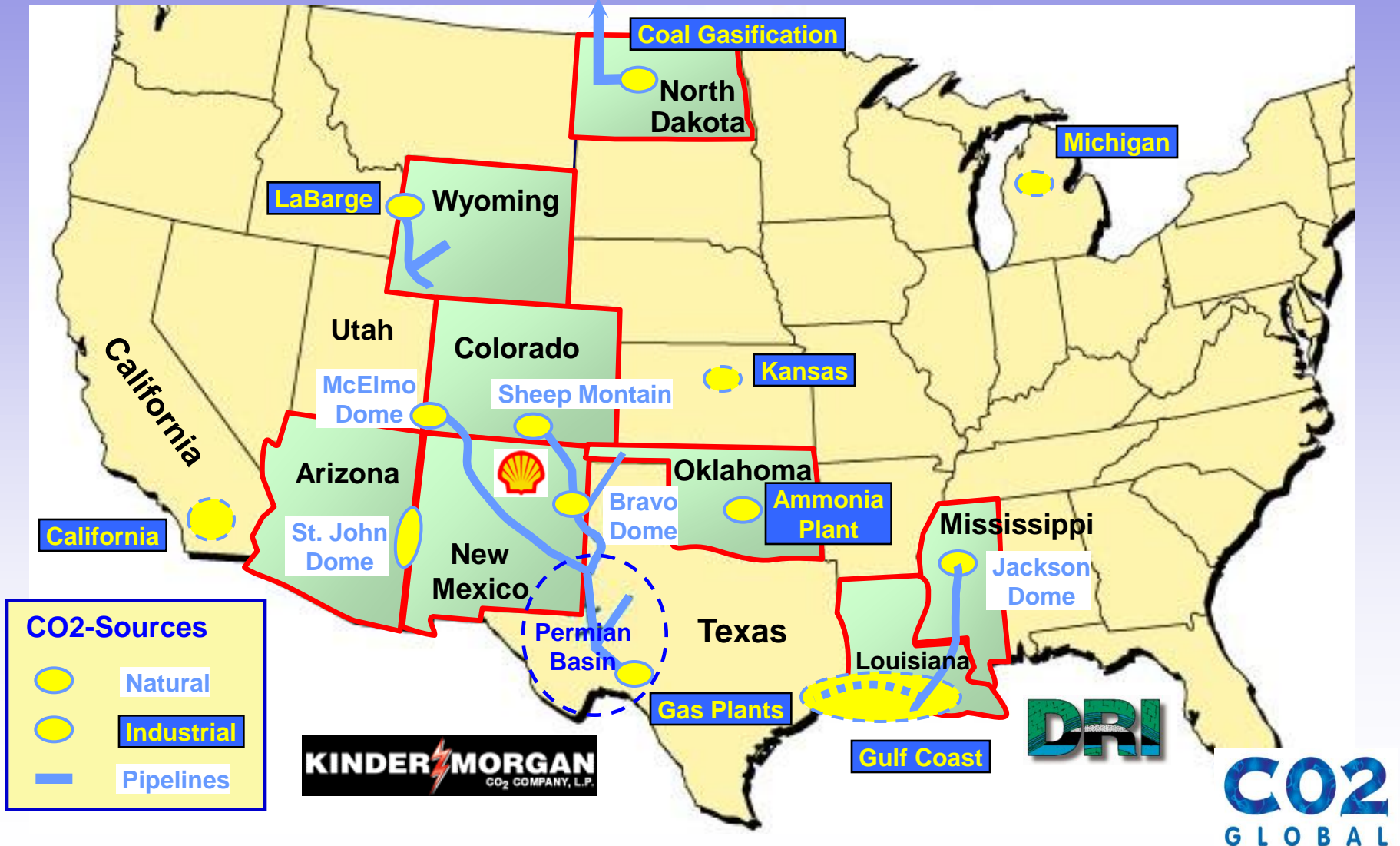

# The Permian Basin in West Texas & New Mex.

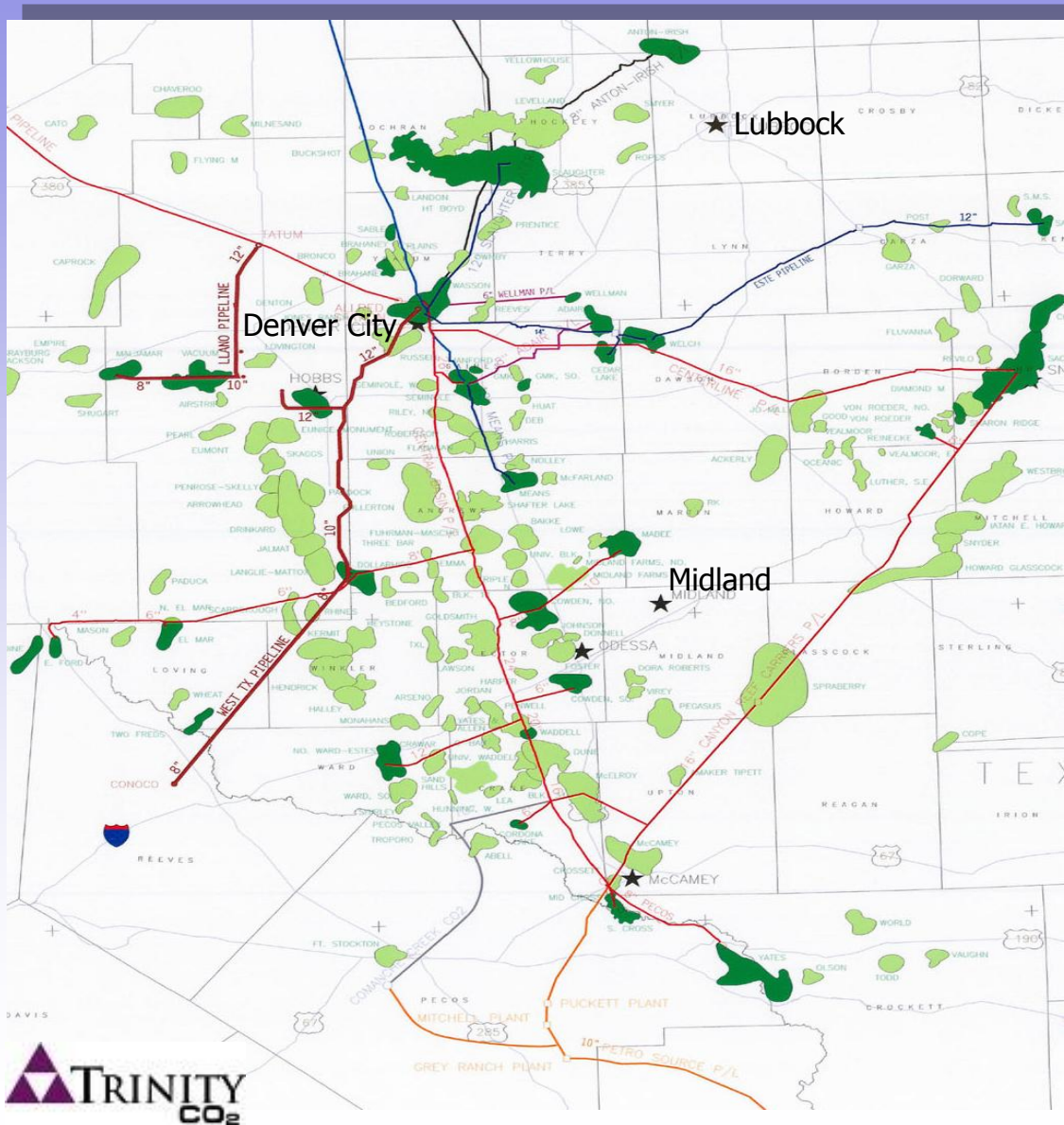

- The Permian Basin is a prolific CO2 arena with ~70% of global CO2-EOR production.
- Current supply is 1.6 bcfd CO2 yielding ~180,000 bbl of incremental oil per day.
- Map shows an area covering ~ 40,000 sq miles in West Texas and the SE part of New Mexico;
  - Dark green represents existing CO2-floods.
  - Light green are the new recognised opportunities.
- The “ring main” pipeline ensures some flexibility of supply, but ....
- Region is short!

# Growth of CO<sub>2</sub>-EOR in the Permian Basin

- The Permian, West Texas has a strong engineering community with “hands-on” experience for managing all aspects of CO<sub>2</sub>-flooding. This includes;
  - Overall process design and implementation.
  - Plant integration with existing and new CO<sub>2</sub>-floods.

- Operation & Maintenance covering;
  - Corrosion management
  - Recycle of CO<sub>2</sub>
  - Measurement & monitoring
- Optimal sub-surface use of injected CO<sub>2</sub>.
- Texas understands legal aspects of mineral rights and pore space!

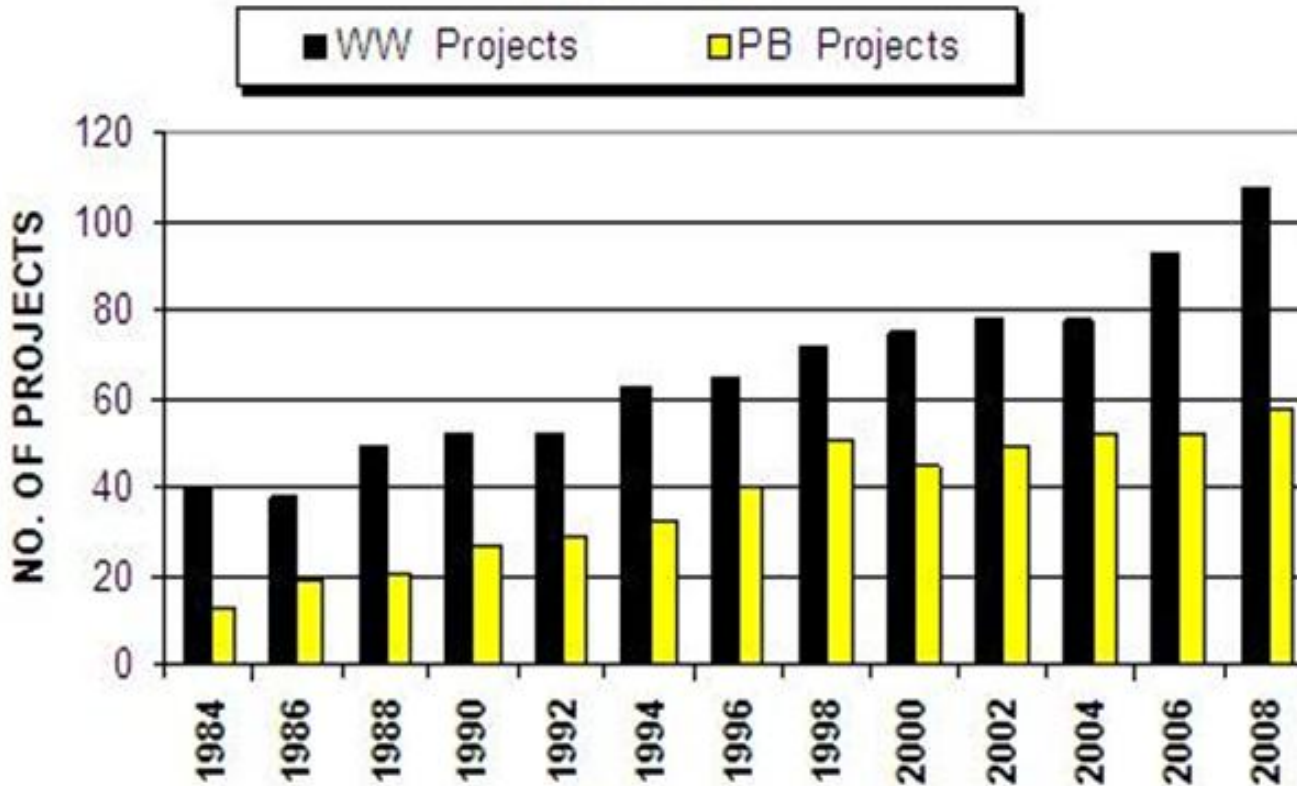

# Cumulative CO2-EOR Oil Production

- Cumulative CO2-EOR oil production in the Permian Basin passed ONE billion barrels in 2006 representing ~80% of total U.S. capacity.

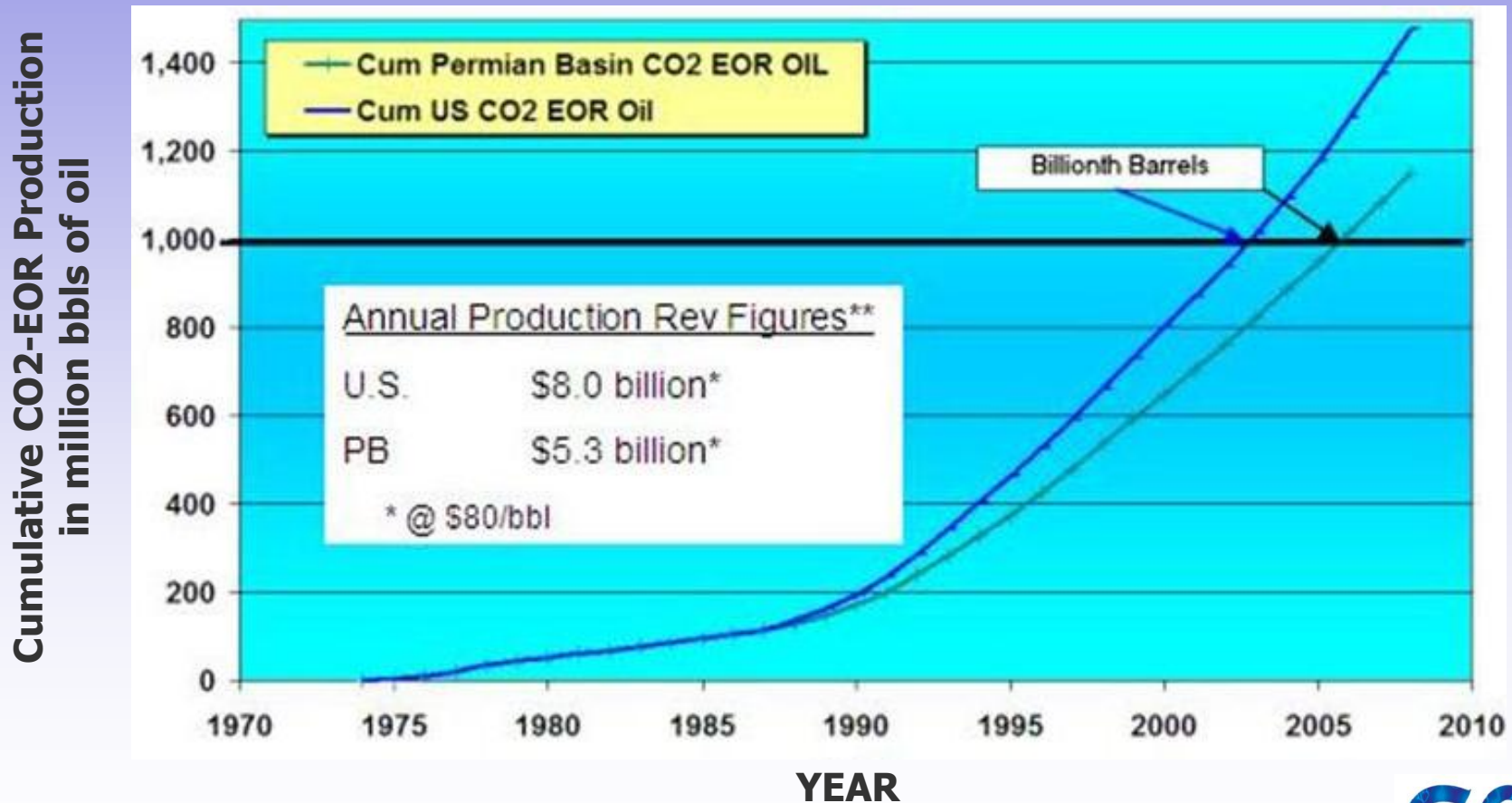

# Historical Variation of Supply & Demand

- A changing market with current shortfall of ~550 MMcfd of CO<sub>2</sub> supply.

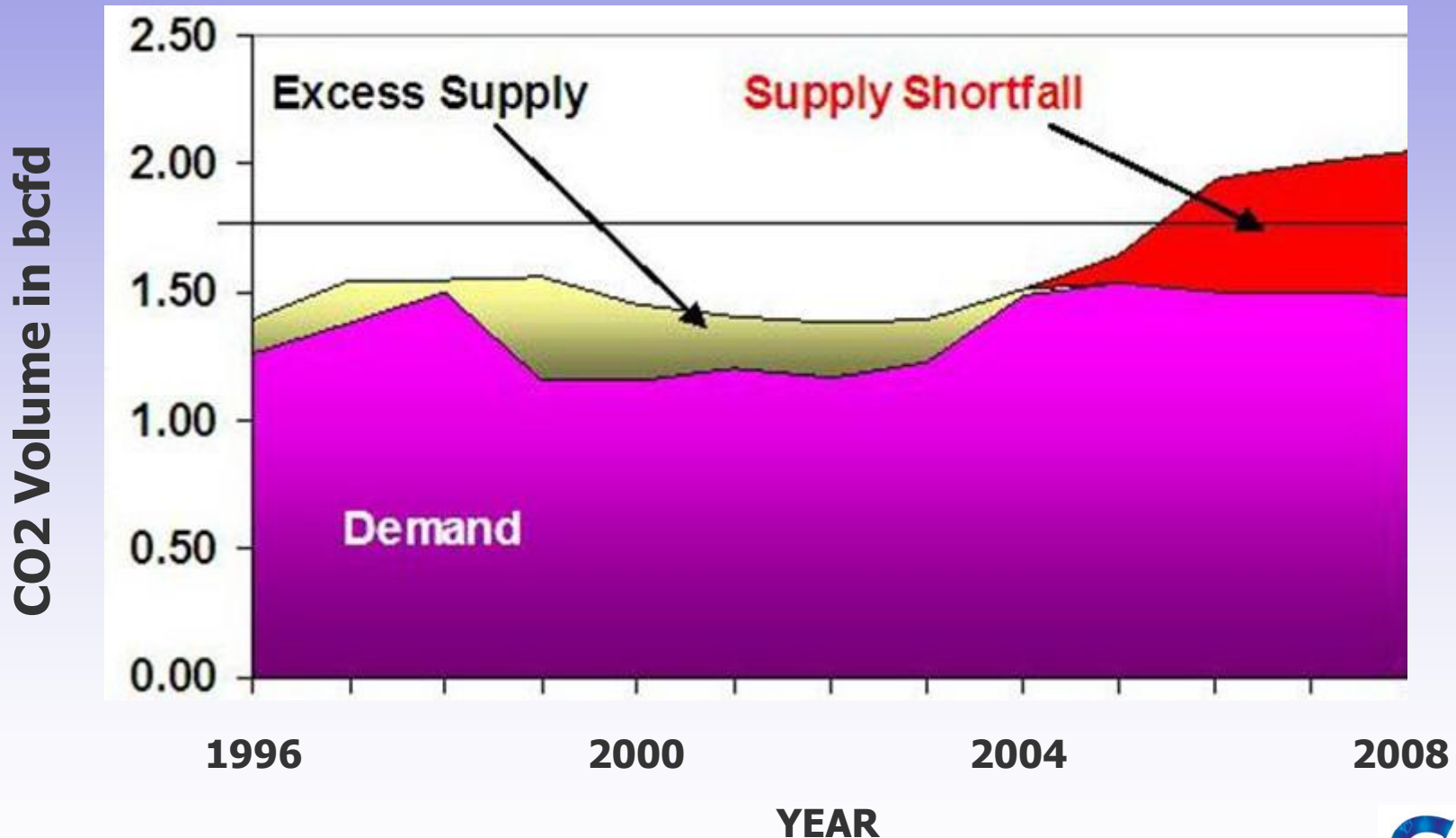

# Pipeline Development during 1975 - 2005

- **Constructed over 30 years**
- **Economic Drivers**
  - Oil Price
  - Tax Incentives to ensure “Security of Supply”
- **90% Natural CO2 Supply**
- **Built by Shell & Mobil**
- **Main Players are now;**
  - ExxonMobil
  - Oxy-Permian
  - Kinder Morgan CO2
  - Denbury Resources
  - Trinity CO2



# Status of Supply into the Permian Basin

- Present CO<sub>2</sub> supply is 1.6 bcf/d with ~180,000 bbls EOR production;
  - Market is significantly short with depletion in main supply domes
  - Estimated 0.5 - 1.0 bcf/d shortfall leaving “pent-up” demand ...
  - Releasing this is very dependent upon timing!
  - ... but larger volumes of CO<sub>2</sub> from power generation is difficult to integrate with current EOR opportunities despite the short market
  - Long-term supply and demand of both CO<sub>2</sub> and power is therefore difficult to match.
- New focus on “CO<sub>2</sub>-rich” NG is opening supply-side, but also ...
  - Creating higher demand for compression power
  - Necessitates identification of a pathway for further expansion of the infrastructure
  - But can enable early transition from natural to anthropogenic CO<sub>2</sub>.
- Field operators need time and confidence regarding availability of future supply to invest in processing, handling and compression equipment.



# Case Study: CO<sub>2</sub> - EOR at SACROC



- Discovered in 1948
- 81 square miles
- US 7th largest field
- 2.8 bn bbl OOIP
- Max. 211,000 BOPD
- ~1,700 wells



Central Control Room

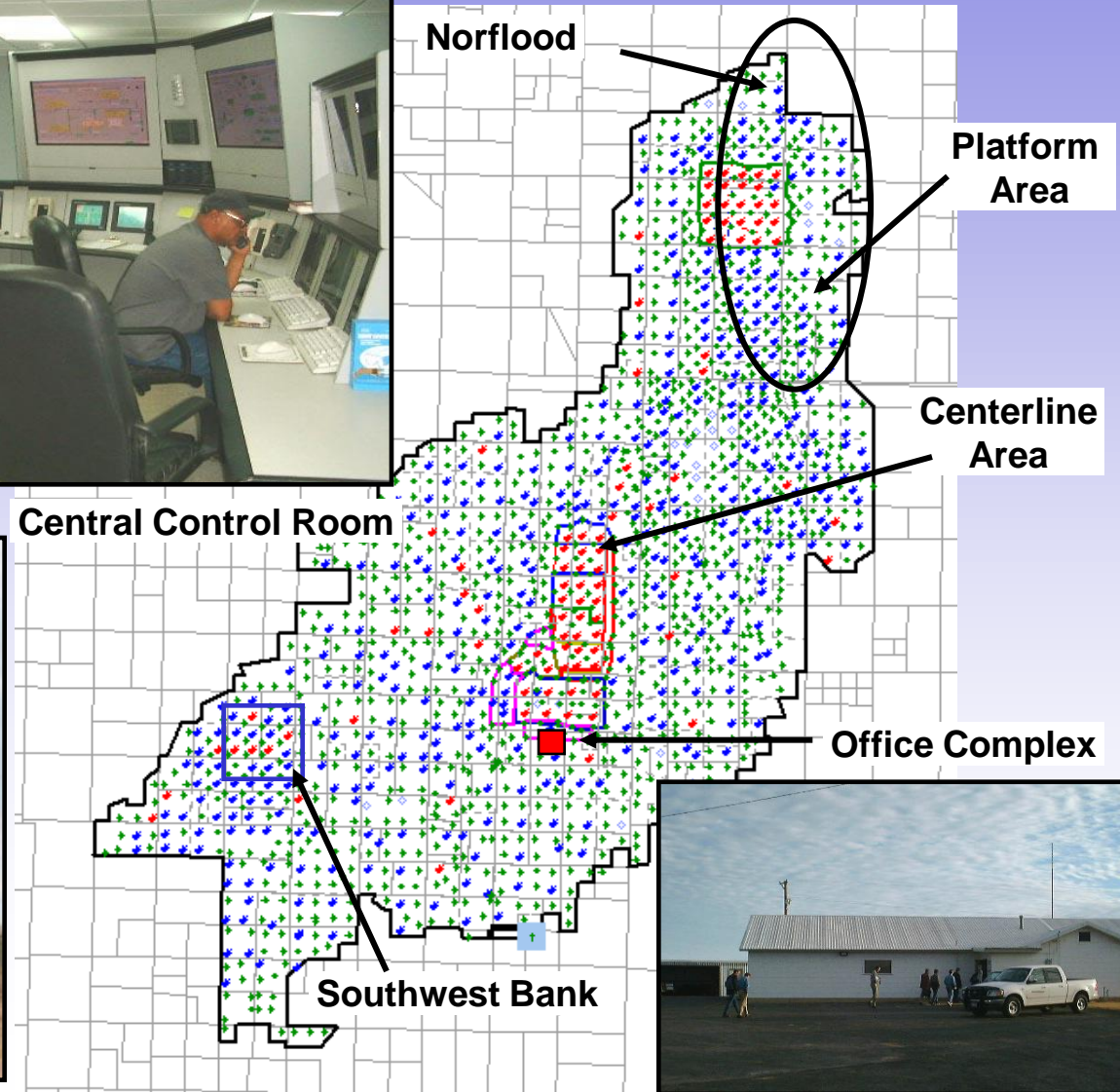

# SACROC Production History



- 2003 Production
  - 12,000 BOPD
  - 94 MMscf/D
  - 165,000 BWPD
- 2003 Injection
  - 200,000 BWPD
  - 3.5 mtCO<sub>2</sub>/yr
- Tertiary Recovery
  - First injection 1972
  - CO<sub>2</sub> from vent stacks (associated gas)

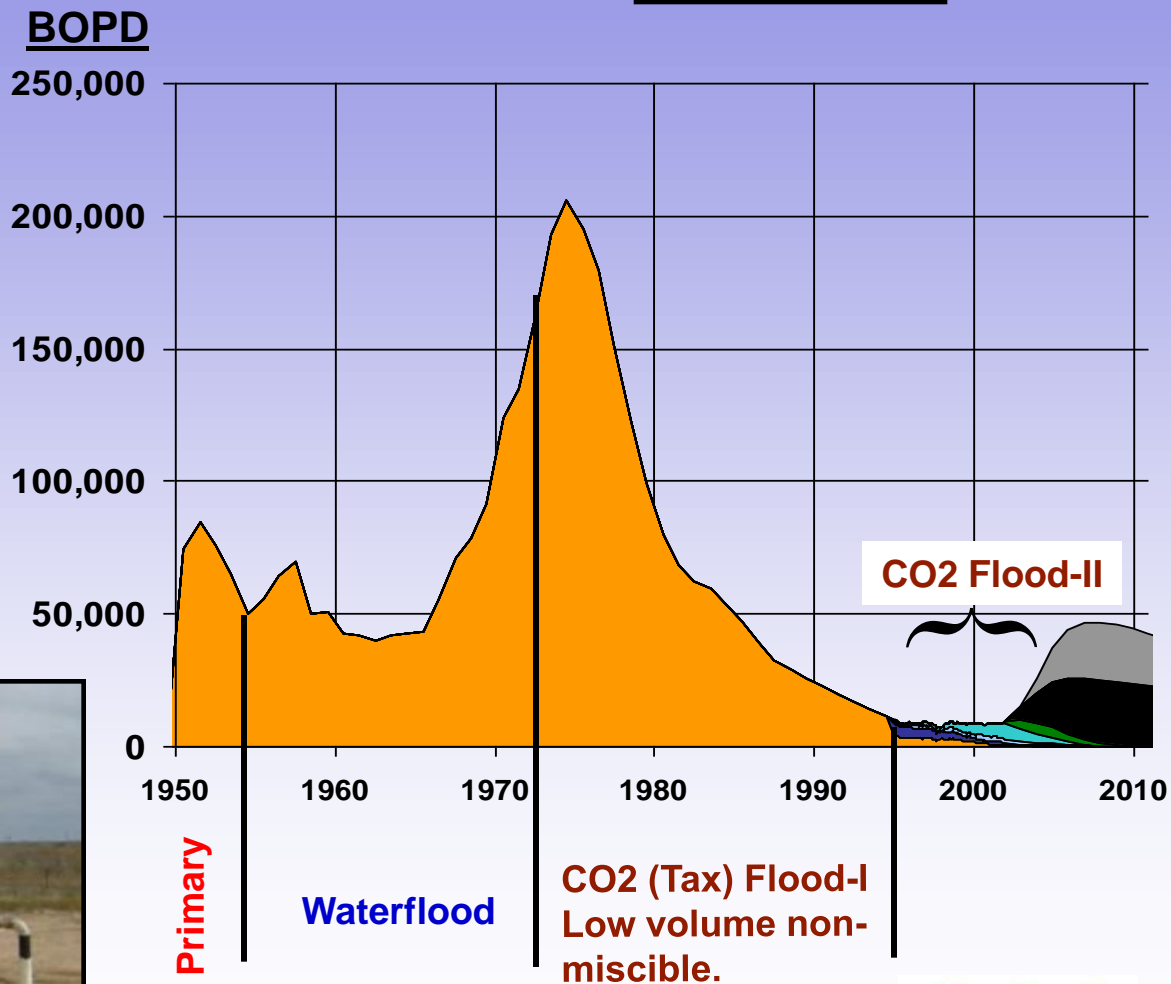

Injector well with both CO<sub>2</sub> and water for WAG EOR

# Producer Well Head Treatment



(1) Producer Well



(3) Oil and Gas Separator Tanks



(2) Well Header Manifold



# CO2 Management & Recycling



Membrane module is packed with 5 micron diameter fibres providing a maximum contact area.



Membrane Separation System



# CO2 Compression Facilities

## The CO2 Recompression Plant (in 2002)



- Ten compressors
- 30,000 H.P. installed
  - 1 at 2,000 H.P.
  - 4 at 2,250 H.P. each
  - 4 at 3,500 H.P. each
  - 1 at 5,000 H.P.
- Electric drive (synchronous)
- 90 mmscfd (1.8 mt/yr) capacity
  - 20 mmscfd at 7 PSIG
  - 70 mmscfd at 40 PSIG
- 40 mmscfd expansion on-going



# Brief Look at the Evolving CO<sub>2</sub>-EOR Market into East Texas

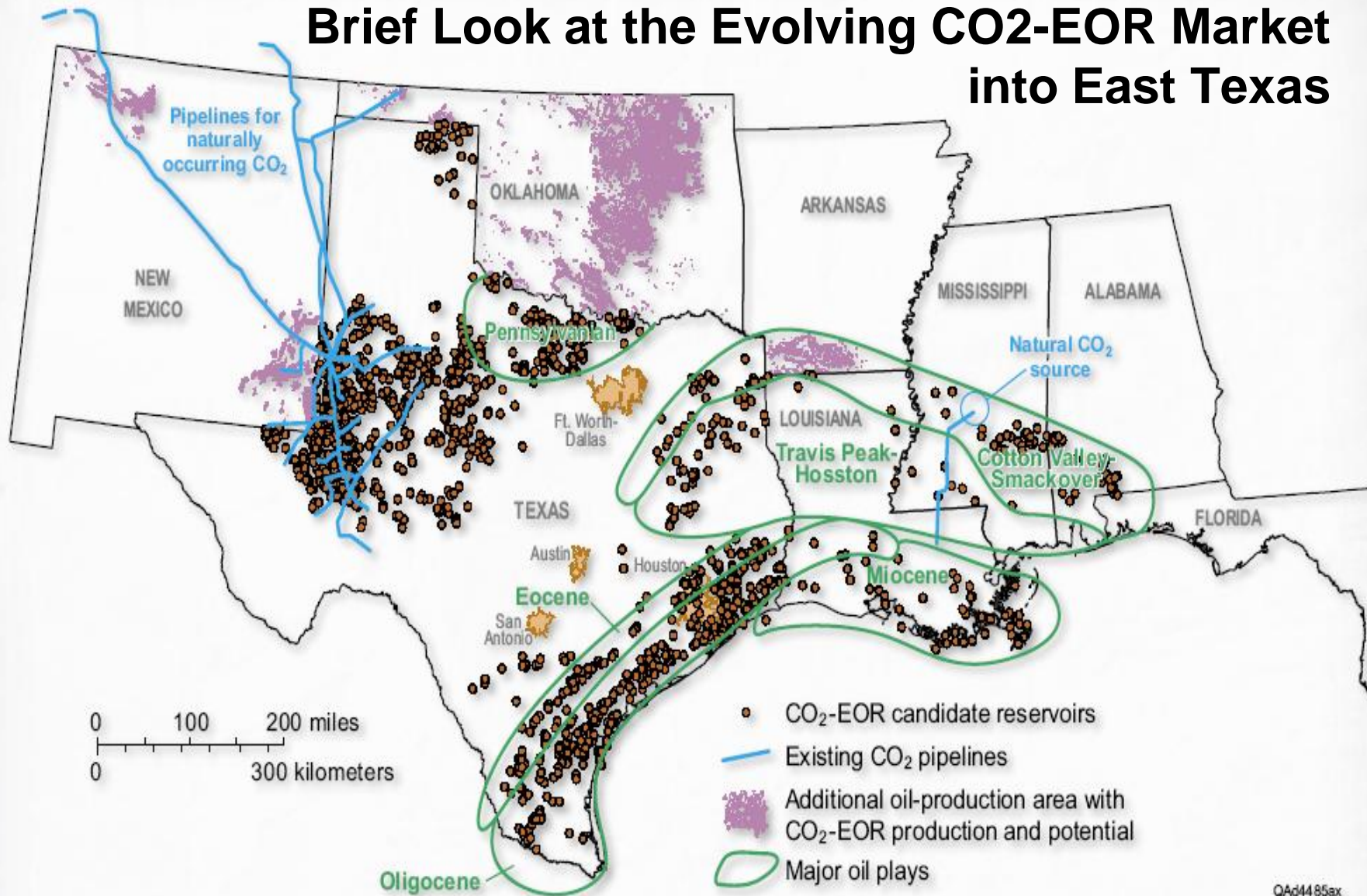

QAd4485ax

- **House Bill 3732** provided tax incentives from 2008 for both anthropogenic CO<sub>2</sub> and Advanced Clean Energy Projects.
- **Bailout Bill** included \$10 credit per ton anthropogenic CO<sub>2</sub>-EOR

# Early North Sea Infrastructure Concepts

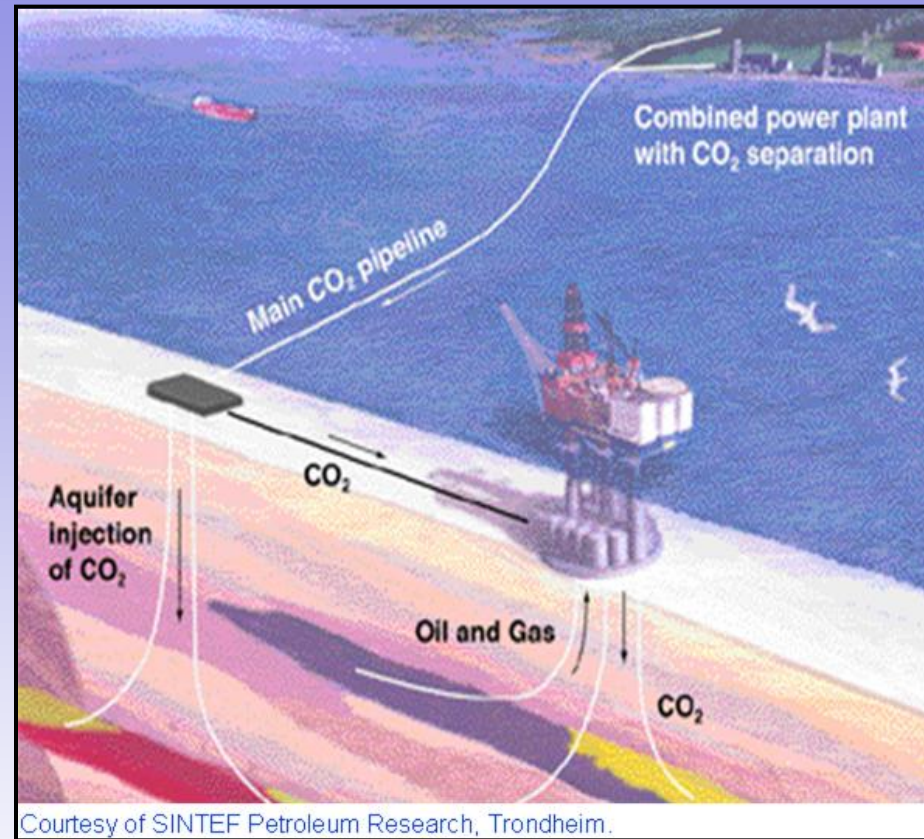

Courtesy of SINTEF Petroleum Research, Trondheim.

Image taken from work by Torleif Holt & Erik Lindeberg, SINTEF (1999).

From *"The Norwegian CO2 Infrastructure Initiative: A Feasibility Study"* by Hustad, CO2-Norway AS. Presented at GHGT-5, Cairns, 2000.

**CO2**  
GLOBAL

# Early NS CO<sub>2</sub>-EOR Concepts (1998)

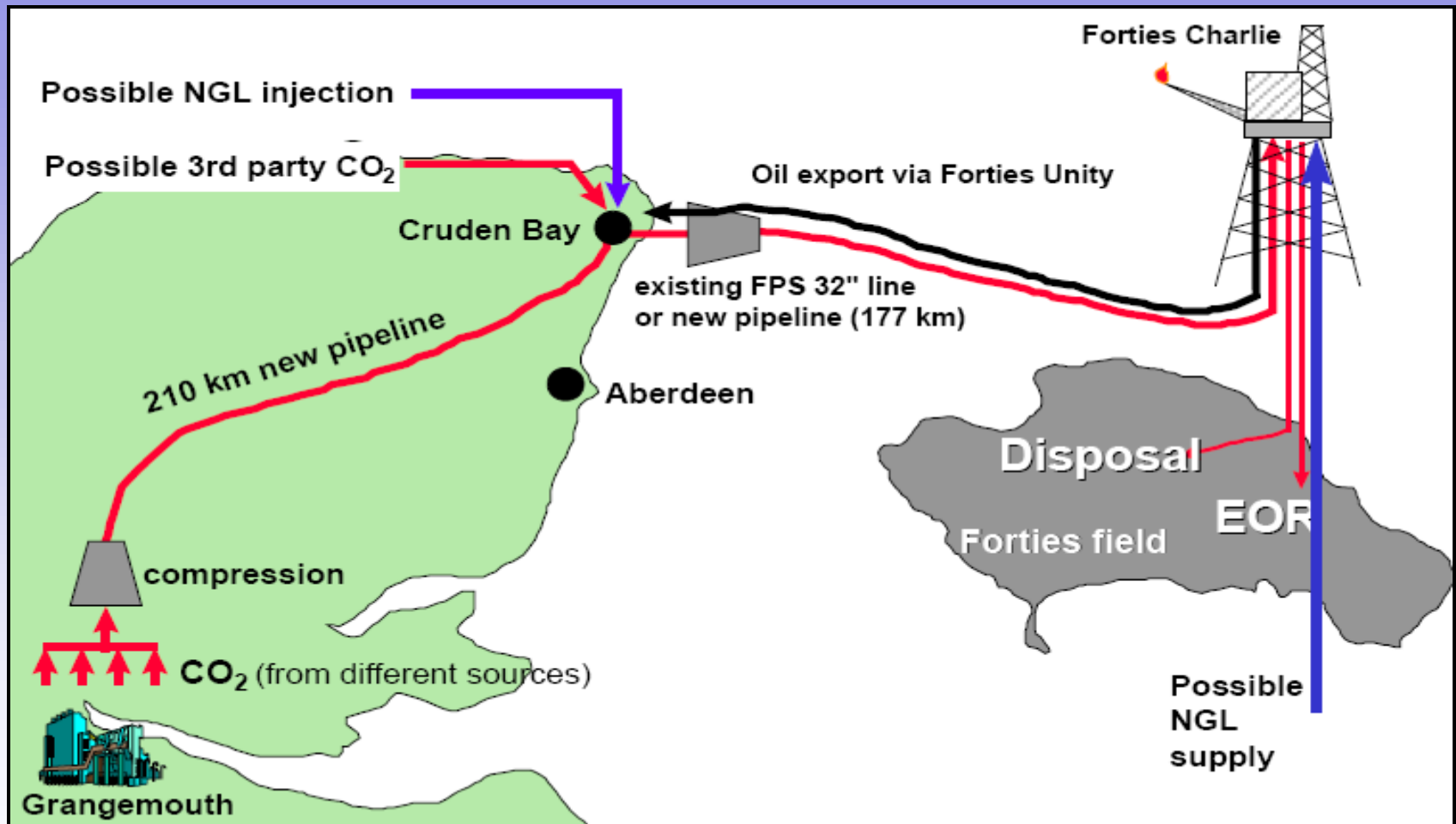

Image from "Options for Establishing a North Sea Geological Storage Hub" by Tony Espie, BP Amoco Exploration. Presented at GHGT-5, Cairns, 2000.





# CENS Project (2001-2004) CO2 - EOR in the North Sea

- Potential delivery of CO2 for EOR through infrastructure at cost of ~ \$35 /tCO2 (2002).
  - Screening of the most mature EOR fields indicated potential of > 30 mtCO2/yr for +20 year period.
  - A combination of pipelines and ship transportation enhanced flexibility and economics for initial EOR projects.
- † Designated fields were “potential” CO2-floods.

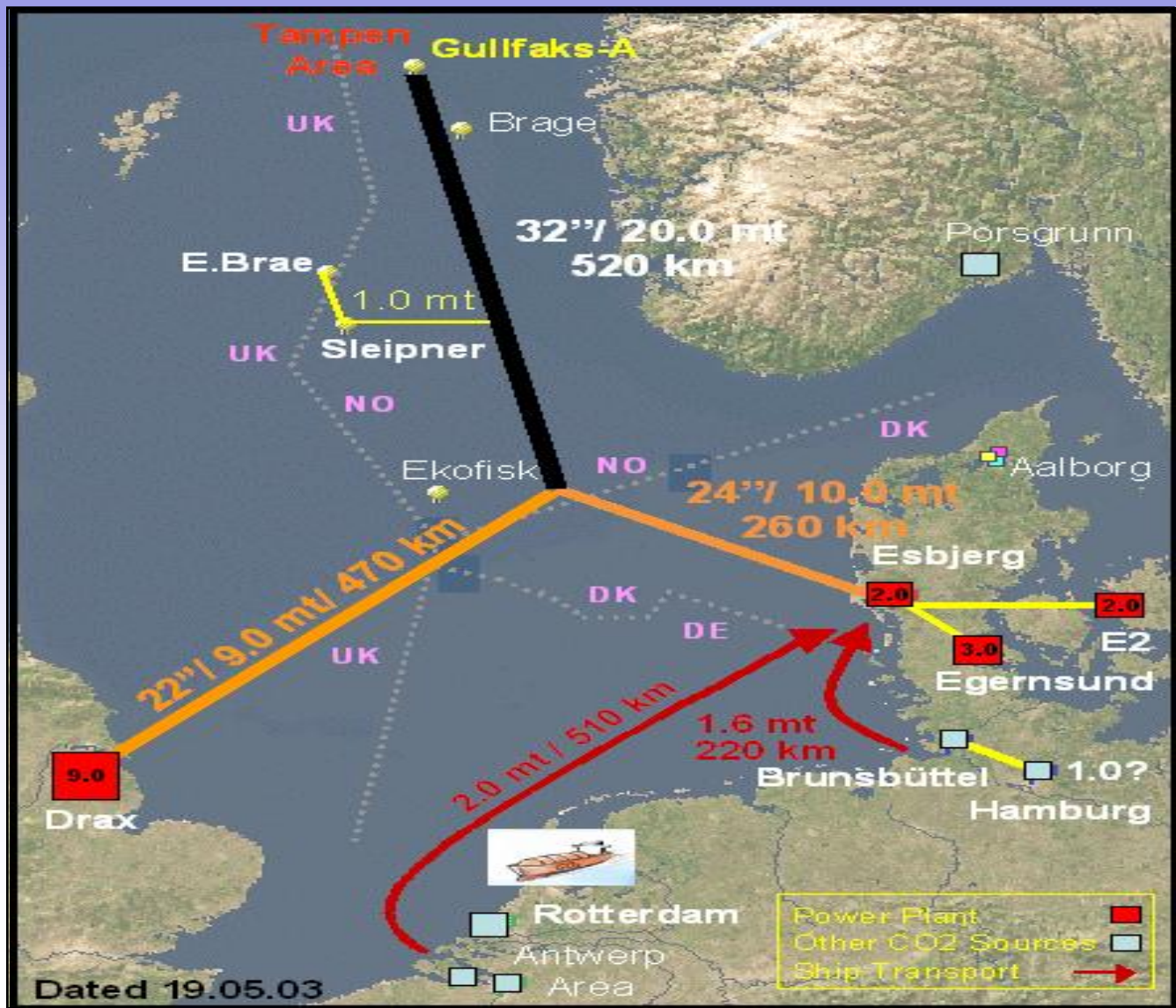

# Future Roadmap: CENS Phase-1 Early Projects (2012 – 2015)

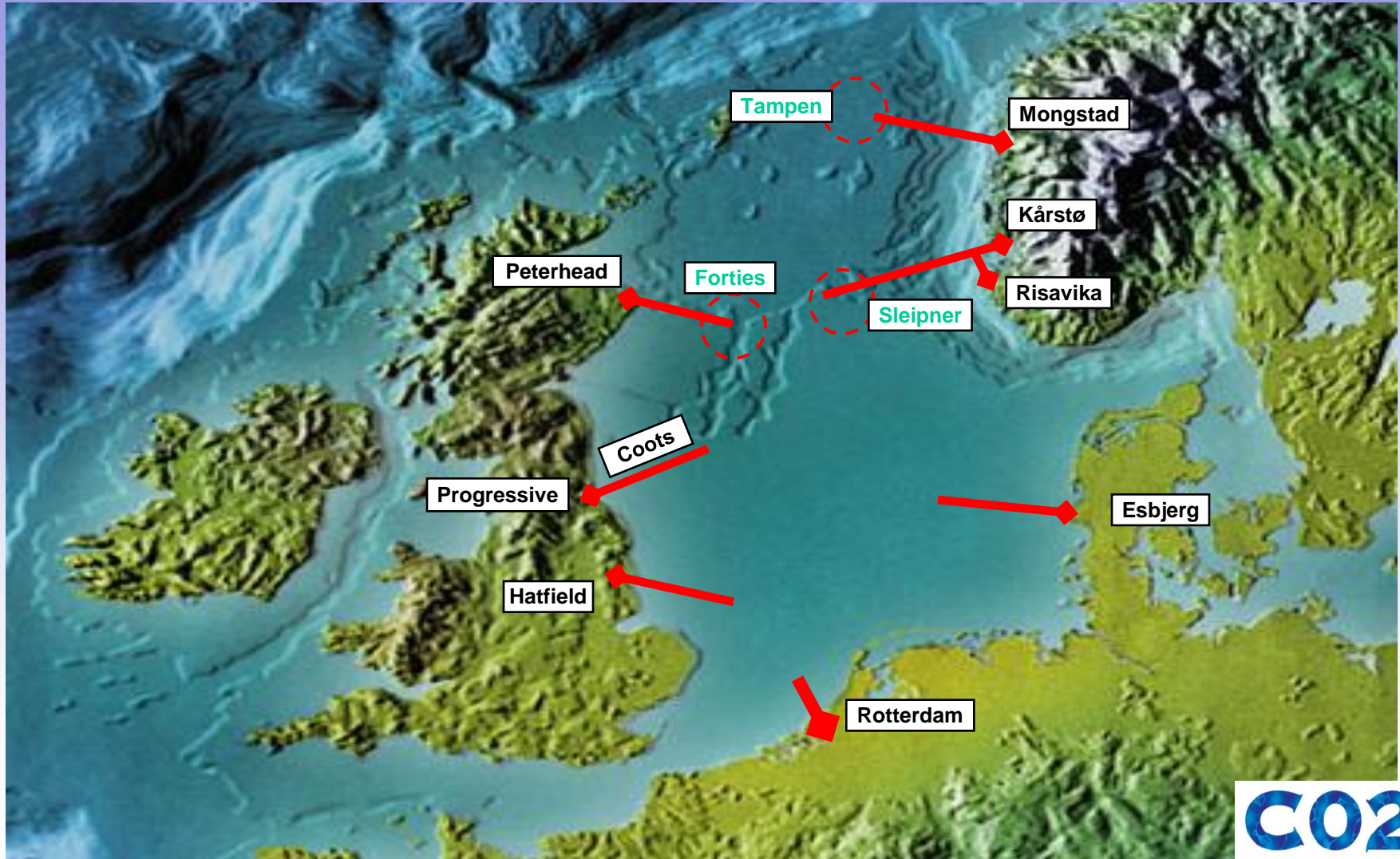

# Future Roadmap: CENS Phase-2 Interconnections (2015 – 2025)

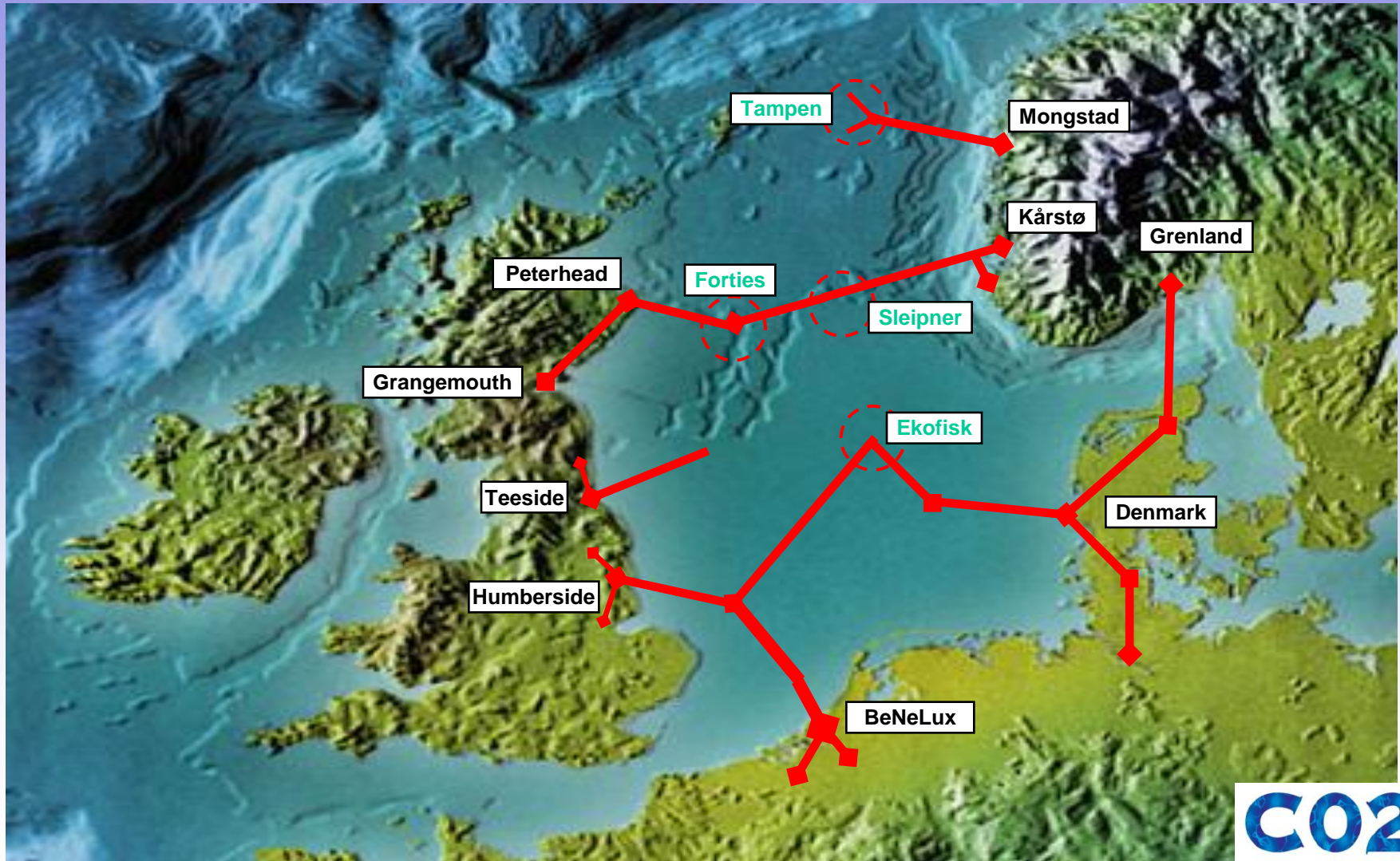

# Future Roadmap: CENS Phase-3 System Looping (2025 – 2035)

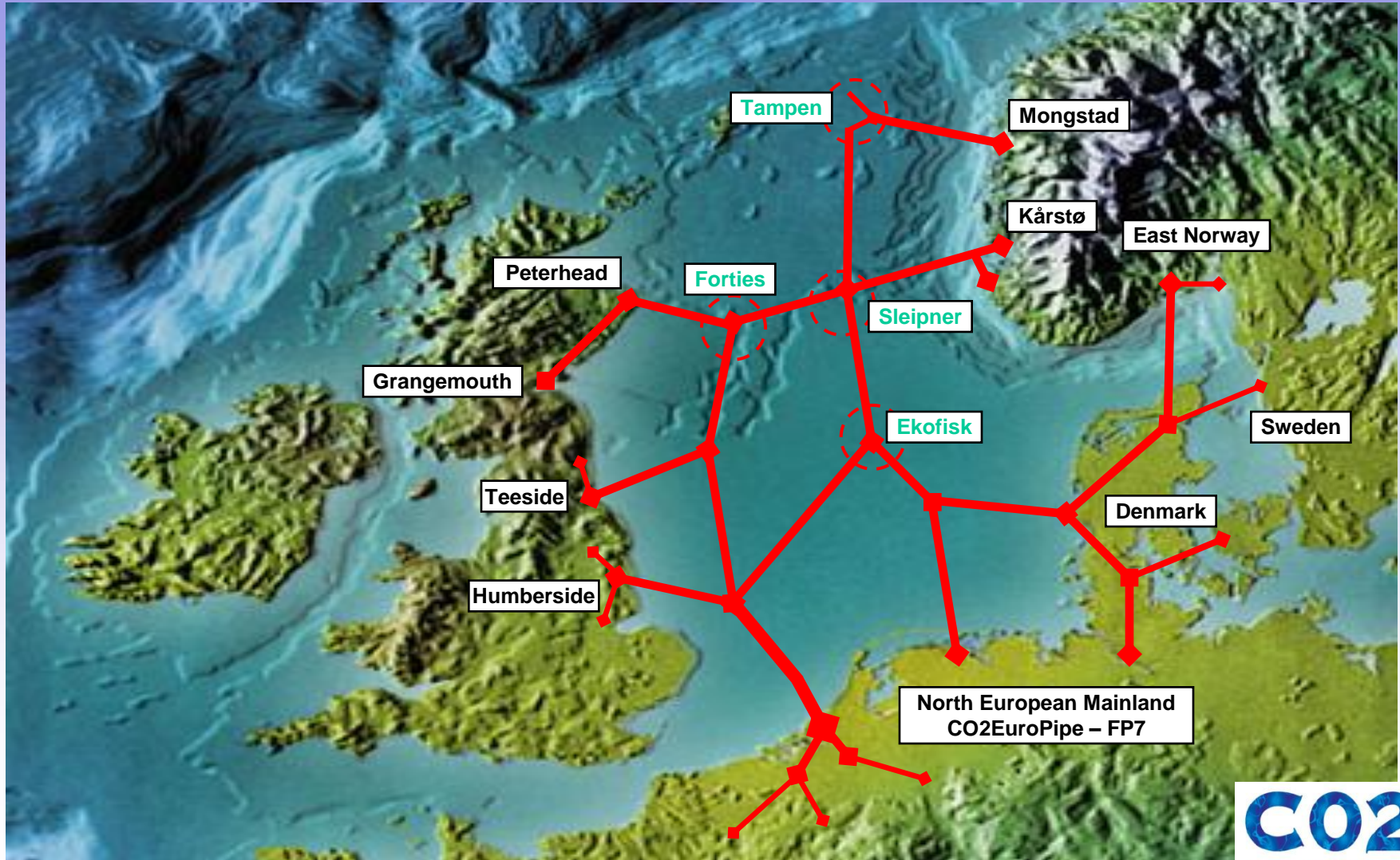

# **Deployment of Zero-Emission CES Power Plants for CO<sub>2</sub>-EOR in the Permian Basin**

Project Development Presentation

November 2008

# Overview of Presentation

- **The CES Zero Emission Power Plant**
  - The Multi-Fuel Oxy-Power Generation Concept
  - The Kimberlina Demonstration Power Plant
  - The 170 MW<sub>t</sub> CES Gas Generator
  - Integration with the reconfigured GE J79 oxy-turbine expander
  - Technology Development Roadmap
- **Commercial Deployment of CO<sub>2</sub> with Power**
  - Unique features needed for success
  - Managing project risk and upsides
  - Opportunities for future growth
  - The development team and partnership

# Schematic Overview for the Multi-Fuel Capability of the CES Power Plant

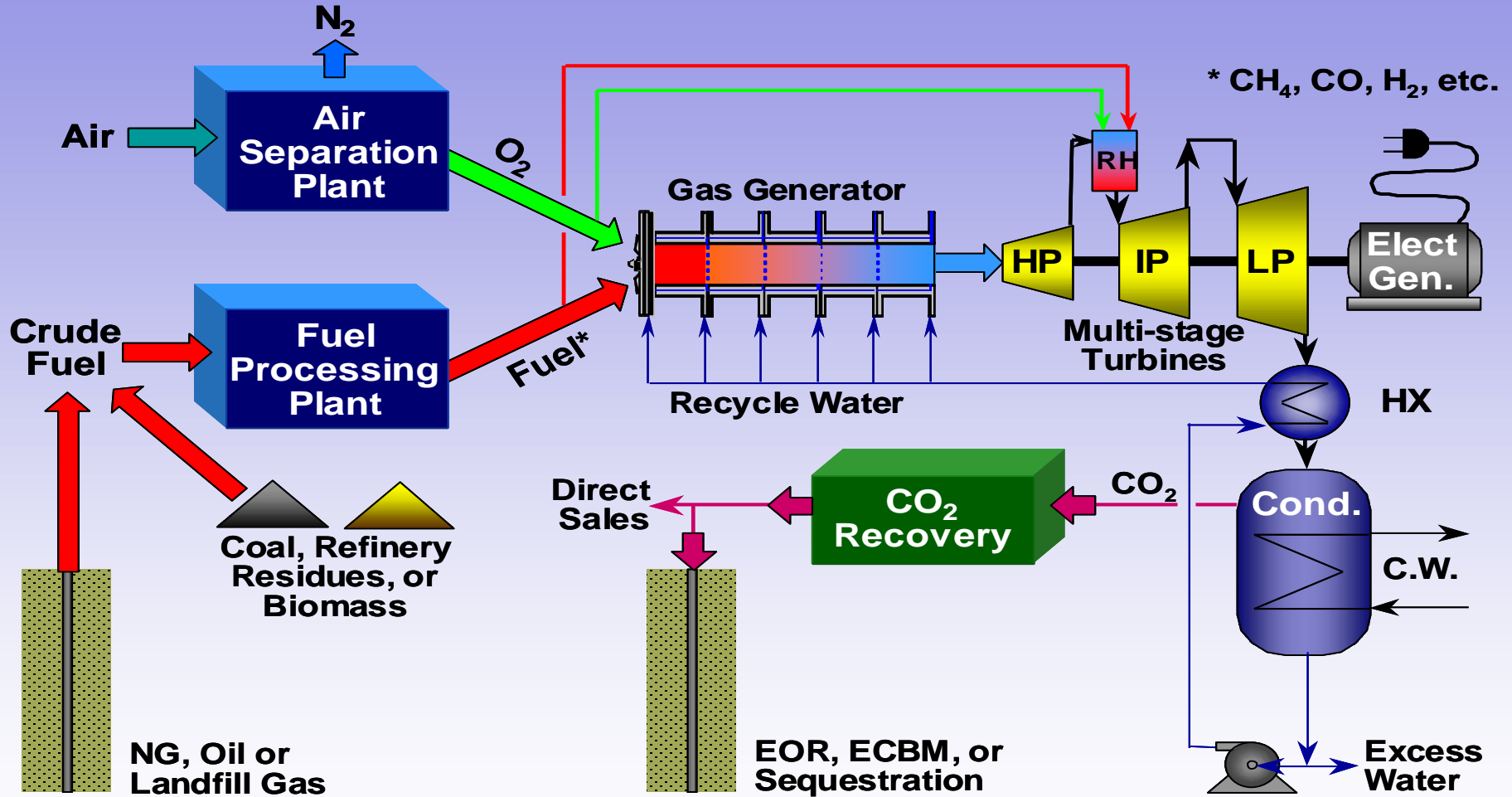

Clean Energy Systems Inc.  
Sacramento, Ca.



# The CES Demonstration Power Plant

- Since 2005 CES have deployed the technology at their 5 MW<sub>e</sub> Kimberlina Power Plant, nr. Bakersfield, Ca.;
  - First generation 20 MW<sub>t</sub> Gas Generator has completed +1,500 hr.
  - More than 300 start / stop sequences
  - Demonstrated extensive multi-fuel capability (incl. “low-btu” gas)
  - Received insurance cover in 2006
  - Supplies no-NOx power to PG&E.



- 
- Second generation 170 MW<sub>t</sub> Gas Generator is currently being tested for commercial delivery starting 2010;
    - Extensively skid-mounted
    - All-up plant Capex is \$125 – \$150 m inclusive of ASU & CO<sub>2</sub>-compression
    - Can be fully installed on-site in the Permian Basin by late-2010.
  - Key performance parameters are;
    - 50 MW<sub>e</sub> power available for export
    - 15 MMBtud fuel-gas used
    - 15 – 30 MMcfd (supercritical) CO<sub>2</sub> available for export
    - 160,000 galls/day water produced
    - 28 MMcfd Nitrogen.



# The CES Zero Emission Power Plant

- Installation of the 170 MW<sub>t</sub> CES Gas Generator on-site at Kimberlina;
  - Design and production started in 2006.
  - Installed and first-firing 3Q-2008.
  - Gas Generator is fully containerised and skid-mounted.
  - Undergoing final verification and endurance testing during 2009 prior to commercial deployment.



Kimberlina Oxy-Test Facility - 2008

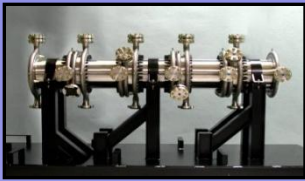

# The CES 170 MW<sub>t</sub> Gas Generator

- A unique oxygen and fossil-fuel combustor based on well-proven rocket propulsion technology;
  - Very compact design with no moving parts
  - Easily interchangeable components
  - The 20 MW<sub>t</sub> prototype has been operating in the demonstration plant since 1Q-2005.
- More than \$100 million investment in development work since 1998;
  - Funded by California Energy Commission (CEC) and U.S. Dept. of Energy
  - Collaborating with major industrial gases, energy and power companies
  - CES also have private investment capital to commercialise the technology.



Clean Energy Systems Inc.  
Sacramento, Ca.

**CO<sub>2</sub>**  
GLOBAL



# The CES 170 MW<sub>t</sub> Gas Generator

- Detail below showing Gas Generator “in-situ” inside container with main feed lines for fuel gas, oxygen and water entering into the combustor section.

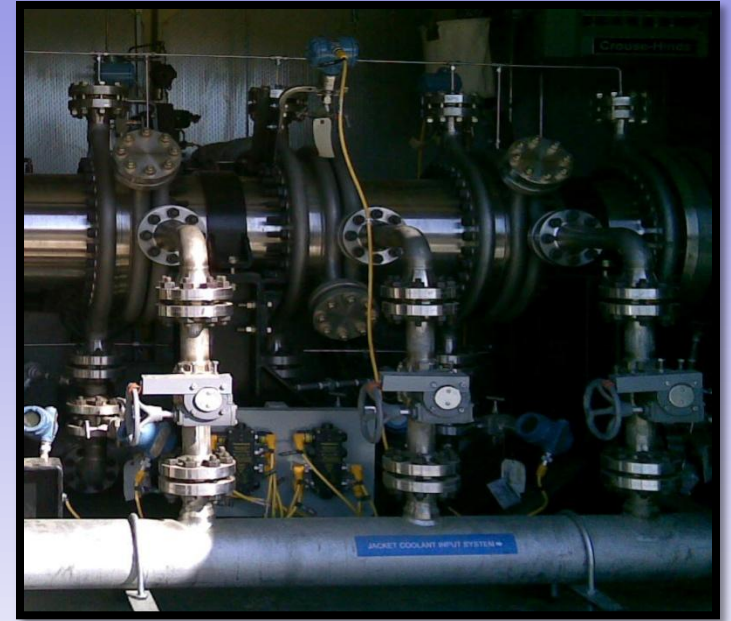
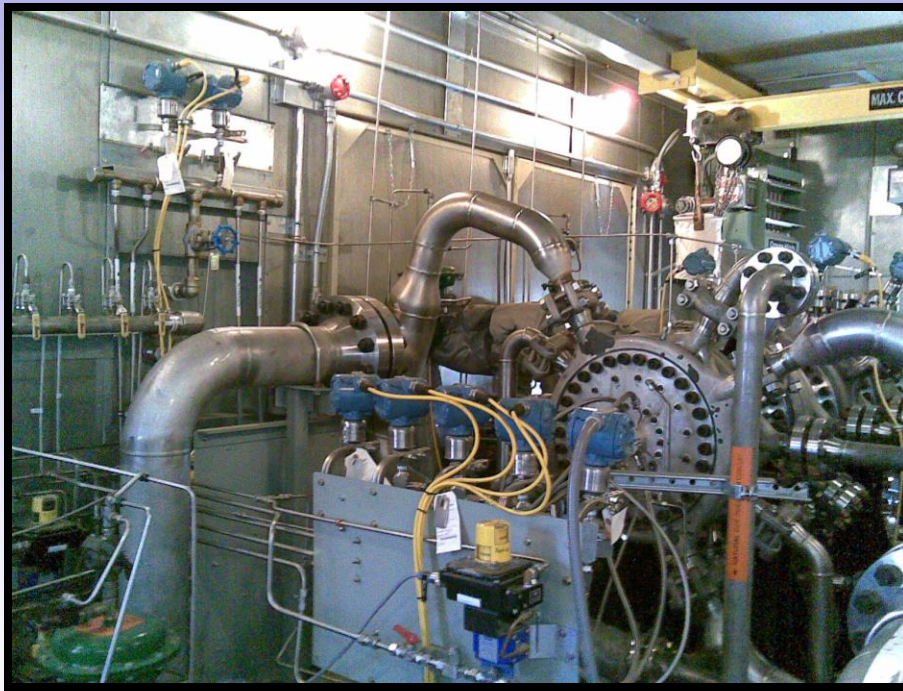

- Detail above showing multiple staged-cooling sections (with water injection) to control temperature before entering the turbine expander.



Clean Energy Systems Inc.  
Sacramento, Ca.

**CO<sub>2</sub>**  
GLOBAL

# The Oxy-Turbine Expander

- The Gas Generator produces high-pressure and high-temperature steam (with ~10%-mol CO<sub>2</sub>).
- To date CES have been expanding this through a conventional steam turbine (shown right).



- CES is currently using a modified GE J79 aero-derivative turbine enabling higher turbine inlet temperature (TIT) and overall plant efficiency.

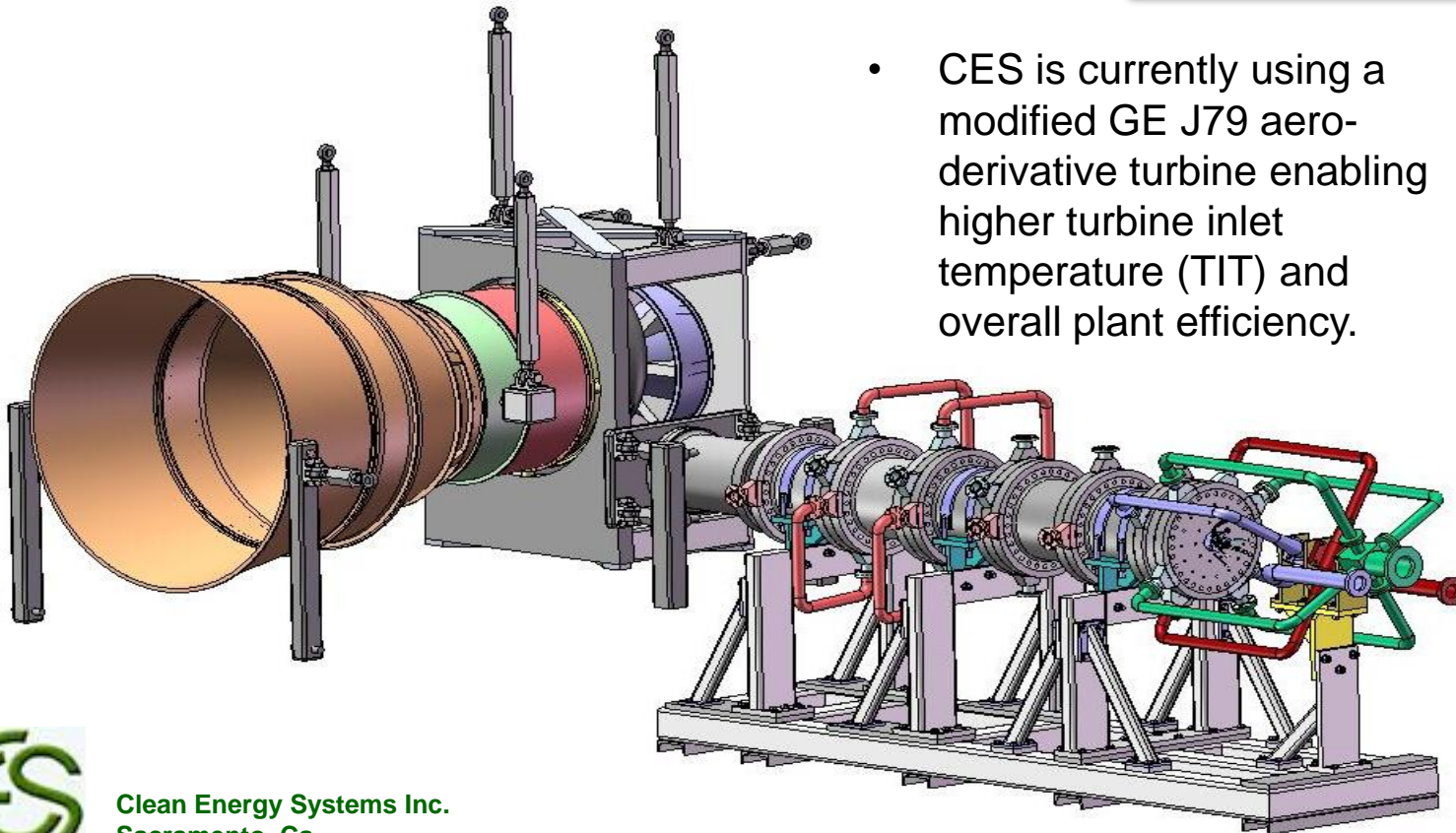

Clean Energy Systems Inc.  
Sacramento, Ca.

CO<sub>2</sub>  
GLOBAL

# The CES Kimberlina Oxy-Test Facility

- The GE J79 Oxy-Turbine was installed during 4Q-2008 following successful initial commissioning of the Gas Generator that was undertaken during 3Q-2008.
- Image (from Sept 2008) shows foundations with tie-in to the Gas Generator in container and exhaust stack.



- The Kimberlina Oxy-Test Facility is currently limited by fuel and Oxygen supply to max. 80 MW<sub>t</sub> input representing 40% of the Gas Generator power capability.
- A full-size 170 MW<sub>t</sub> power plant is being constructed on site for operation in 2011 as part of the Dept. of Energy Carbon Sequestration Program.



Clean Energy Systems Inc.  
Sacramento, Ca.



# Technology Development Roadmap

- The Zero Emission CES technology has an identified commercial pathway to higher efficiency and reduced costs in order to become competitive with established coal and NG power generation.

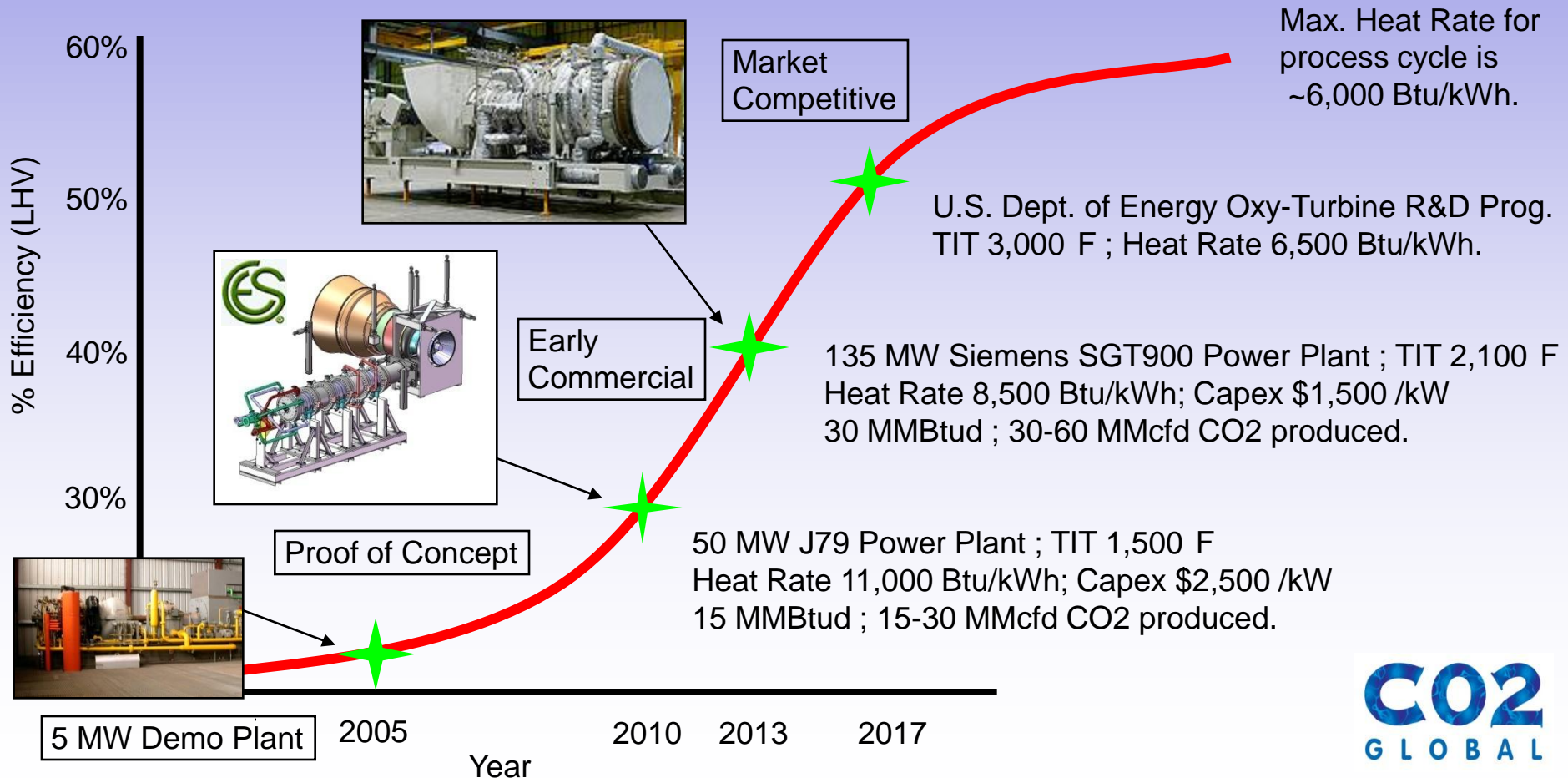

# Unique Features Needed for Success

- The First Generation CES Power Plant will exploit unique niche market opportunities in the Permian for near-term commercial deployment;
  - Use of low-quality “CO<sub>2</sub>-rich” untreated fuel-gas
  - Strategically site power plants in order to take advantage of CO<sub>2</sub> demand
  - Initial opportunity for CO<sub>2</sub> supply is independent of pipeline investment ...
  - But long-term will want to access the CO<sub>2</sub>-pipeline infrastructure
  - Can supply “Base-load” power at outer edges of the ERCOT electricity grid.
- A detailed knowledge of the Basin is therefore necessary to identify and get access to such special locations.
- There is a clear “First-Mover” advantage obtained by providing anthropogenic CO<sub>2</sub> to the region.
- The CES Power Plant will also open other “new” and larger project opportunities for partners and investors in the future.

# Managing Project Risk & Upsides

- Deployment of zero emission power generation combined with CO2 capture for EOR has not been done commercially before ...
- However Technology Risk is low because the core new component comprising the CES Power Unit is;
  - Modularised, flexible and predominantly skid-mounted
  - Represents only ~25% total plant investment capex
  - The ASU is well proven and represents ~35% total capex
  - Penalty for oxygen production will reduce in the future due to an increasing demand for large-scale oxygen plants in industrial processes
  - Remaining Balance of Plant is based on standard components.
- Market Risk needs to be reduced through long-term contracts;
  - For power and fuel this is feasible
  - For CO2 it is possible with a dedicated CO2-transporter managing risk and volume fluctuations throughout power plant project life.
  - Increased shortfall of CO2 in the Permian Basin is a market driver.
- Commercial Risk is manageable despite general engineering cost-fluctuations and early implementation of zero-emission power plant technology but that will also target future market for CCS.



# The CO2-Global Development Team

- CO2-Global has a core management team with in-depth experience from following areas;
  - Power plant & commercial contract development
  - CCS technology (RD&D) + commercialisation
  - Power and energy market trading
  - Corporate and Senior Board experience
  - Strong investor backing
- CO2-Global has long relationship with CES including;
  - Unique rights of technology deployment for CO2-EOR in the Permian Basin
  - Non-circumvention for other identified projects
- CO2-Global is collaborating with key companies in the Permian;
  - Nicholas Consultancy Group is a leading surface plant process design and CO2 engineering company based in Midland, Tx.
  - Trinity CO2 Company has extensive assets in the Permian Basin;
    - Owns and operates over 200 miles CO2 pipeline
    - Buys, sells and transports 200 MMcfd CO2

# Overview of Recent Comparisons for Advanced Oxyfuel Cycles

# Main Oxyfuel Cycles Considered

- Original MATIANT CO<sub>2</sub> Cycle (1994)
- Basic CES Water Cycle (2003)
- S-Graz Cycle (2004)
- LP Reheat Cycle (2005)
- LP Reheat Regenerative (Recycle) Cycle (2006)
- ZENG LP-Twin Cycle (July 2007)
- CES – ZENG Cycle (Aug 2007)

# Computational Assumptions

Isentropic efficiency of compressors C1 and C2	0.87
Isentropic efficiency of compressors C3 and C4	0.85
Isentropic efficiency of the CH <sub>4</sub> and O <sub>2</sub> compressors	0.75
Isentropic efficiency of pumps	0.75
Isentropic efficiency of the HPT in the CES cycle	0.87
Isentropic efficiency of the HPT in the MATIANT cycle and the proposed cycle	0.85
Isentropic efficiency of IPT and LPT	0.90
Mechanical efficiency	0.99
Atmosphere temperature (ISO standard condition)	15 °C
Compression intercooler and condenser temperature	27 °C
CH <sub>4</sub> delivery temperature	15 °C
CH <sub>4</sub> delivery pressure	3 bar
O <sub>2</sub> delivery temperature	15 °C
O <sub>2</sub> delivery pressure	5 bar
Specific work for air separation	900 kJ/kgO <sub>2</sub> (0.25 kWh/kg)
Combustor pressure drop	3%
Heat exchanger pressure drop	5%
Heat exchanger $\Delta T_{\min}$ for gas/gas	30 °C
Heat exchanger $\Delta T_{\min}$ for gas/liquid	30 °C

- Aspen Plus Simulator Code
- Peng - Robinson EOS
- Max. Combustor Exit Temp. (CET) is 1300 °C
- Heat loss and blade-cooling reduced efficiency ~2%-point
- CO<sub>2</sub> compressed to 300 bar
- C2 and C3 have PR=8.9
- Condenser pressure 0.11 bar

# The MATIANT CO2 Cycle

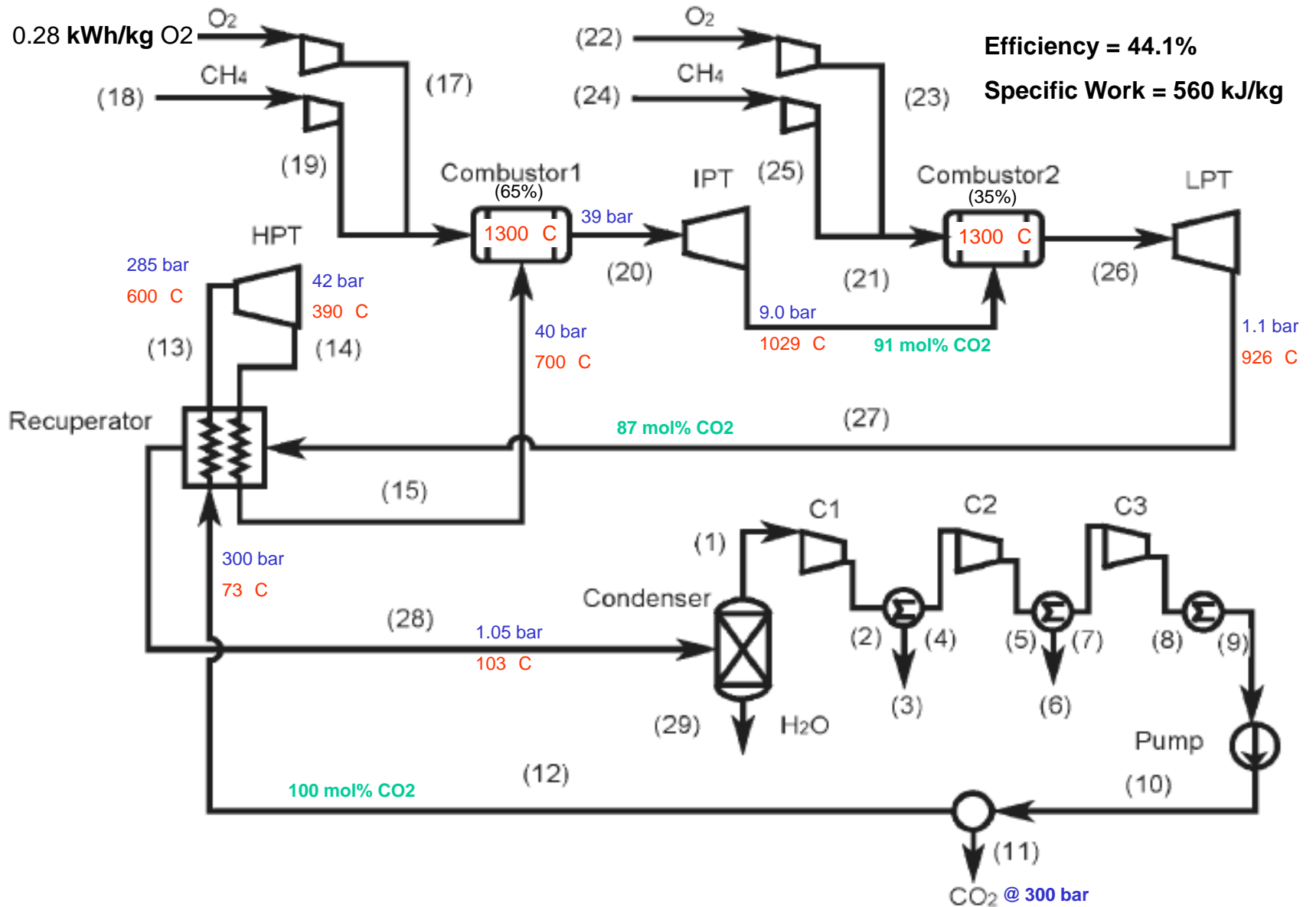

# Basic CES Water Cycle

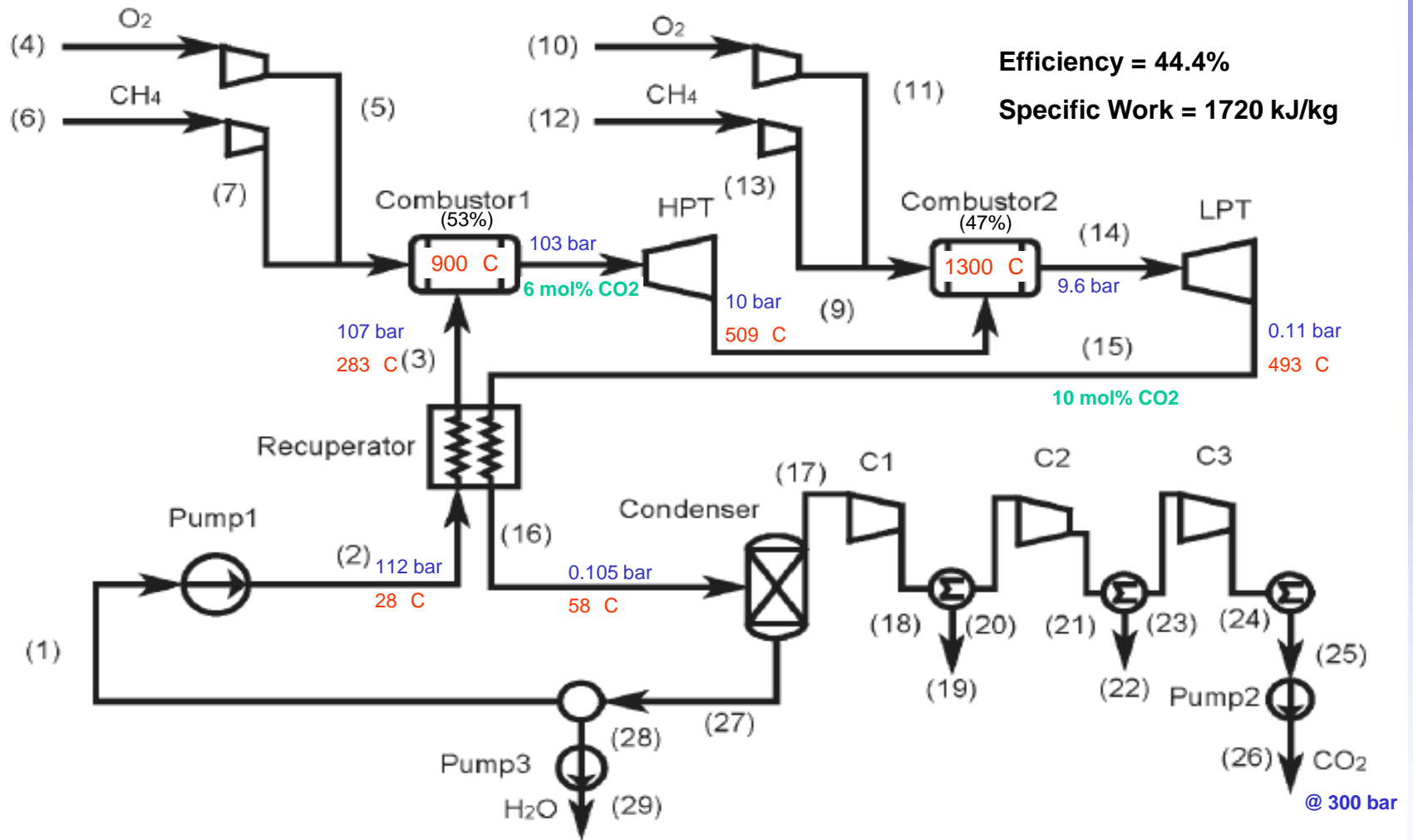

# Low Pressure (LP) Reheat Cycle

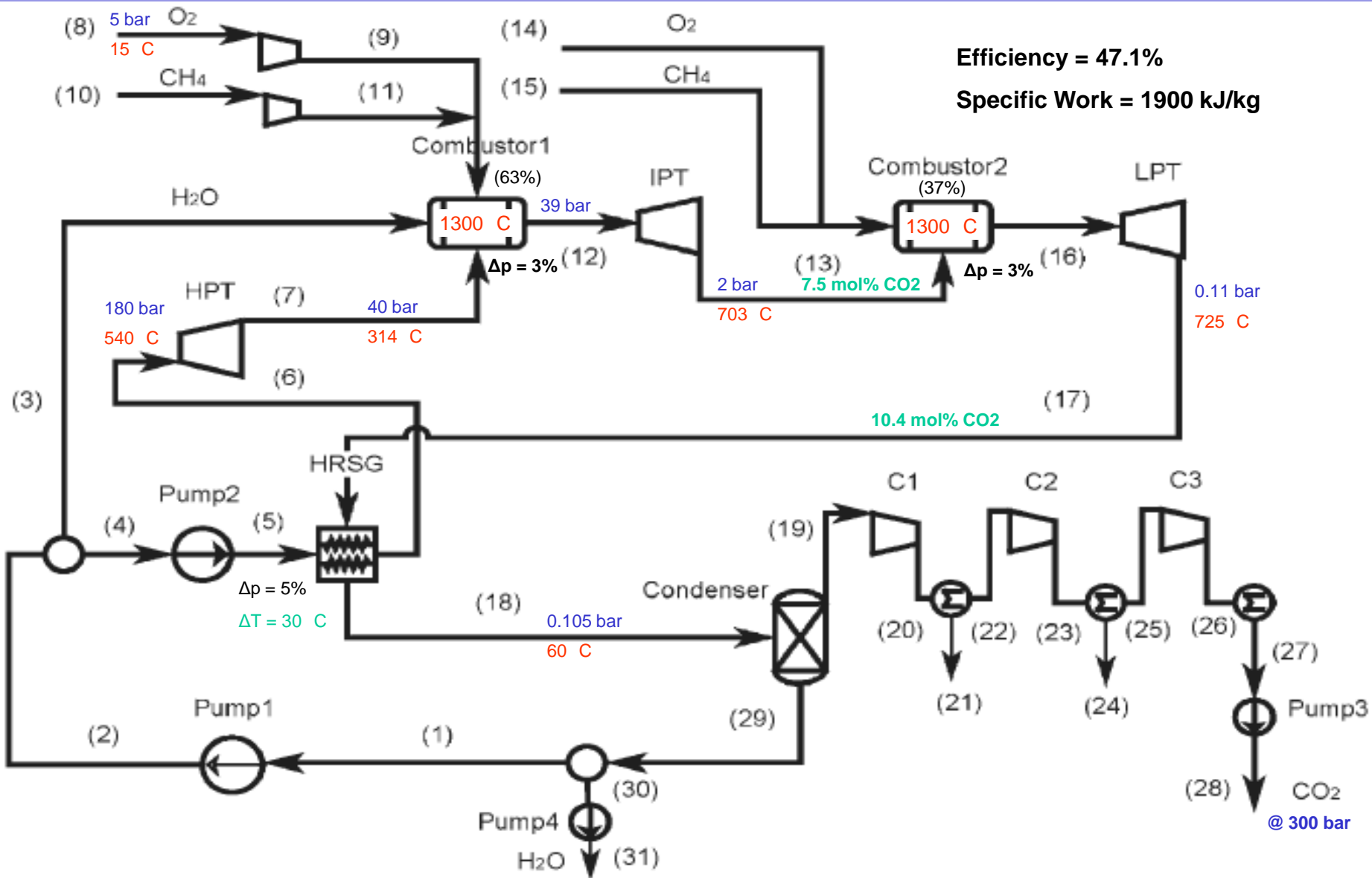





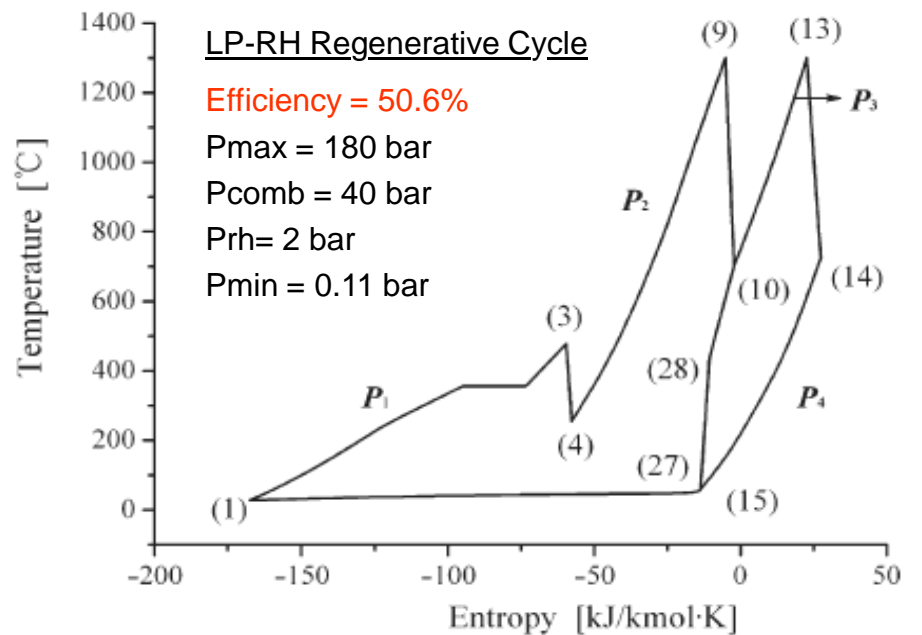
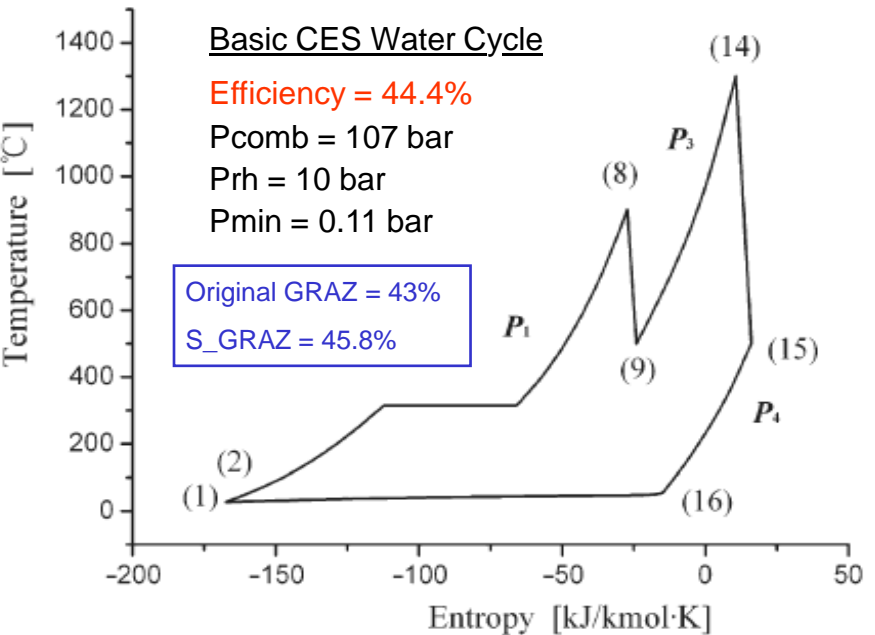
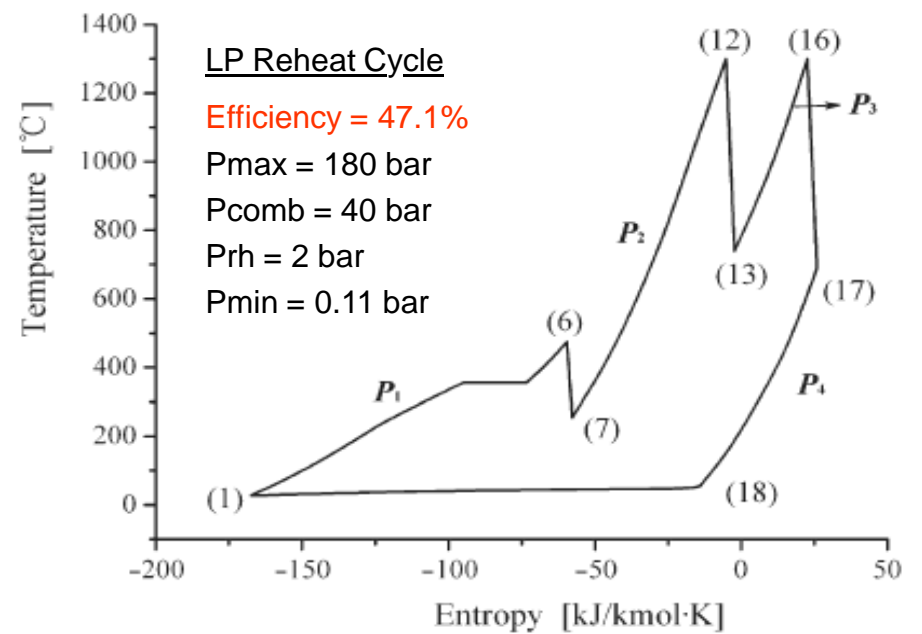
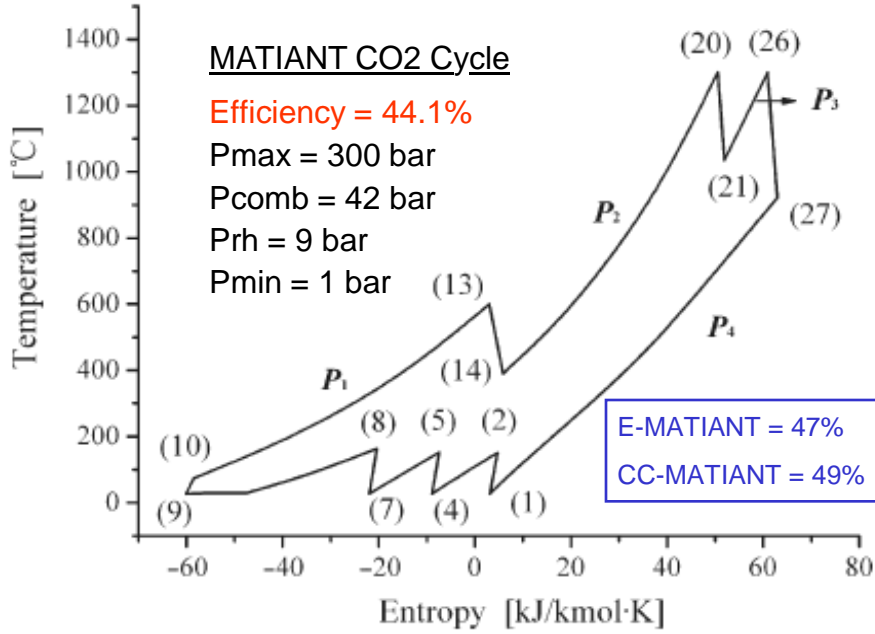

# Exergy Analysis of Cycles

Cycle name		MATIANT		CES		LP-Reheat (RH)		LP-RH Regen	
Item		Exergy (kJ/mol-CH <sub>4</sub> )	Per cent	Exergy (kJ/mol-CH <sub>4</sub> )	Per cent	Exergy (kJ/mol-CH <sub>4</sub> )	Per cent	Exergy (kJ/mol-CH <sub>4</sub> )	Per cent
	LHV of CH <sub>4</sub>	802.80		802.80		802.80		802.80	
	Net input exergy	819.07	100	819.04	100	819.04	100	819.21	100
E x e r g y l o s s	C1-C4	20.96	2.56	2.59	0.32	2.59	0.32	7.88	0.96
	CFO	3.40	0.42	3.90	0.48	2.73	0.33	1.67	0.20
	Pump	6.40	0.78	0.71	0.08	0.85	0.10	0.81	0.10
	Combustor 1	140.59	17.29	184.78	22.56	201.47	24.59	95.30	11.63
	Combustor 2	70.87	8.65	108.47	13.24	82.49	10.07	144.97	17.69
	HPT	11.79	1.44	9.40	1.15	2.61	0.32	3.83	0.47
	IPT	8.05	0.98			10.40	1.27	8.73	1.07
	LPT	12.49	1.52	20.40	2.49	11.28	1.38	16.53	2.02
	HEX	116.96	14.28	58.49	7.13	52.44	6.40	59.11	7.21
	ASUHL	73.86	9.02	73.86	9.02	73.86	9.02	73.86	9.02
	Net output work	353.69		356.43		378.31		406.52	
	Output exergy	819.06		819.04		819.03		819.21	

Exergy (A) = Internal Energy (U) - Sink Entropy term ( $T_0 S$ ) plus a pressure volume term ( $P_0 v$ )

Main conclusion is that exergy losses primarily arise in combustors, heat exchangers and ASU plant.

# Referenced Documentation

- 1 **Kvamsdal, H., Maurstad, O., Jordal, K., and Bolland, O.** Benchmarking of gas-turbine cycles with CO<sub>2</sub> capture. Presented as a Peer-reviewed Paper at the 7th International Conference on *Greenhouse gas control technologies*, Vancouver, Canada, September 2004.
- 2 **Bolland, O., Kvamsdal, H., and Boden, J.** A thermodynamic comparison of the oxy-fuel power cycles Water-cycle, Graz-cycle and MATIANT-cycle. Proceedings of the International Conference on *Power generation and sustainable development*, Liège, Belgium, October 2001.
- 3 **Anderson, R., Brandt, H., Mueggenburg, H., Taylor, J., and Viteri, F.** A power plant concept which minimizes the cost of carbon dioxide sequestration and eliminates the emission of atmospheric pollutants. Proceedings of the 4th International Conference on *Greenhouse gas control technologies*, Interlaken, Switzerland, Pergamon, 1998, pp. 59–62.
- 4 **Anderson, R., Brandt, H., Doyle, S., Mueggenburg, H., Taylor, J., and Viteri, F.** A unique process for production of environmentally clean electric power using fossil fuels. Proceedings of the 8th International Symposium on *Transport phenomena and dynamics of rotating machinery*, Honolulu, Hawaii, March 2000.
- 5 **Marin, O., Bourhis, Y., Perrin, N., Zanno, P., Viteri, F., and Anderson, R.** High efficiency, zero emission power generation based on a high-temperature steam cycle. Proceedings of the 28th International Technical Conference on *Coal utilization and fuel systems*, Clearwater, Florida, US, March 2003.
- 6 **Smith, J. R., Surlles, T., Marais, B., Brandt, H., and Viteri, F.** Power production with zero atmospheric emissions for the 21st century. Proceedings of the 5th International Conference on *Greenhouse gas control technologies*, Cairns, Australia, August 2000.
- 7 **Iantovski, E. and Mathieu, Ph.** Highly efficient zero emission CO<sub>2</sub>-based power plant. *Energ. Convers. Manage.*, 1997, **38**(9999), s141–s146.
- 8 **Mathieu, Ph. and Nihart, R.** Zero-emission MATIANT cycle. *Trans. ASME, J. Eng. Gas Turb. Power*, 1999, **21**(1), 116–120.
- 9 **Mathieu, Ph. and Nihart, R.** Sensitivity analysis of the MATIANT cycle. *Energ. Convers. Manage.*, 1999, **40**(15), 1687–1700.
- 10 **Mathieu, Ph., Dubuisson, R., Houyou, S., and Nihart, R.** New concept of CO<sub>2</sub> removal technologies in power generation, combined with fossil fuel recovery and long term CO<sub>2</sub> sequestration. ASME Turbo Expo Conference, 2000-GT-0161, 2000.
- 11 **Houyou, S., Mathieu, Ph., and Nihart, R.** Techno-economic comparison of different options of very low CO<sub>2</sub> emission technologies. Proceedings of the 5th International Conference on *Greenhouse gas control technologies*, Cairns, Australia, August 2000.
- 12 **Jericha, H. and Fesharaki, M.** The Graz cycle-1500 °C max temperature potential H<sub>2</sub>-O<sub>2</sub> fired CO<sub>2</sub> capture with CH<sub>4</sub>-O<sub>2</sub> firing. ASME paper 95-CTP-79. In ASME Cogen-Turbo Power Conference, Vienna, 1995.
- 13 **Jericha, H., Gottlich, E., Sanz, W., and Heitmeir, F.** Design optimization of the Graz prototype plant. *Trans. ASME, J. Eng. Gas Turb. Power*, 2004, **126**(4), 733–740.
- 14 **Sanz, W., Jericha, H., Moser, M., and Heitmeir, F.** Thermodynamic and economic investigation of an improved Graz cycle power plant for CO<sub>2</sub> capture. Proceedings of the ASME Turbo Expo Conference, 2004, Vol. 7, Paper No. GT-2004-53722.
- 15 **Cai, R. and Jiang, L.** Analysis of the recuperative gas turbine cycle with a recuperator located between turbines. *Appl. Thermal Eng.*, 2006, **26**, 89–96.
- 16 **Anderson, R.** *Development of a unique gas generator for a non-polluting power plant.* EISG Report on Project EISG 99-20, California Energy Commission Grant # 99-20, May 2001.
- 17 **Anderson, R., Baxter, E., and Doyle, S.** *Fabricate and test an advanced non-polluting turbine drive gas generator.* Final Report, under DE Cooperative Agreement No. DE-FC26-00NT 40804, 1 September 2000 to 1 June 2003.
- 18 **Simmonds, M., Miracca, I., and Gerdes, K.** Oxyfuel technologies for CO<sub>2</sub> capture: a techno-economic overview. Proceedings of the 7th International Conference on *Greenhouse gas control technologies*, Vancouver, Canada, September 2004.
- 19 **Velautham, S., Ito, T., and Takata, Y.** Zero-emission combined power cycle using LNG cold. *JSME Int. J. Ser. B; Fluids Thermal Eng.*, 2001, **44**(4), 668–674.
- 20 **Zhang, N., Cai, R., and Wang, W.** Study on near-zero CO<sub>2</sub> emission thermal cycles with LNG cryogenic exergy utilization. *ASME Int. Gas Turbine Inst. Publ. IGTI*, 2003, **3**, 329–337.
- 21 **Zhang, N. and Lior, N.** Configuration analysis of a novel zero CO<sub>2</sub> emission cycle with LNG cryogenic exergy utilization. *ASME Adv. Energy Syst. Div. Publ. AES*, 2003, **43**, 333–343.

The logo consists of the letters 'CO2' in a bold, blue, sans-serif font. The 'O' is significantly larger than the 'C' and '2'. The '2' has a small superscript-like appearance. The letters are set against a white background.



# ZENG Low Pressure Twin Cycle

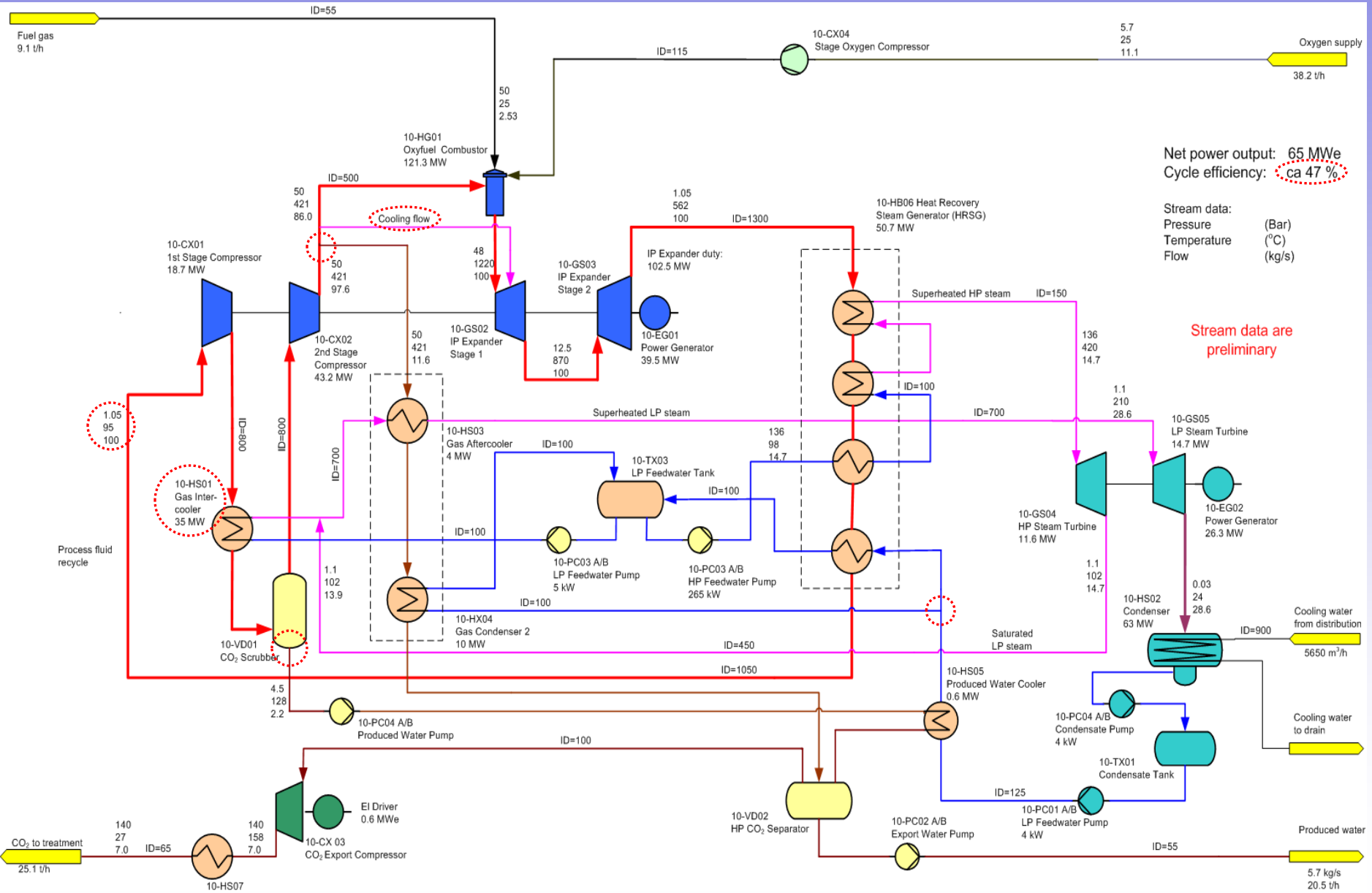

# Thoughts for Advanced Compressors

- **CO2 Compressor Technology Needs**
  - Improved and more accurate Equations of State (EOS) for;
    - CO2 with contaminants
    - CO2 with two-phase steam / water
  - CO2 (with steam) Recycle Recompression
  - Increased Compressor Exit Temperature for enhanced regeneration (compressor blade cooling)
- **Understand the Prevailing Market Conditions**
  - Development Roadmap – identify interim technologies to also create market pull while developing advanced technologies.
  - Identify technology milestones and commercialisation strategy

## Session 6.3

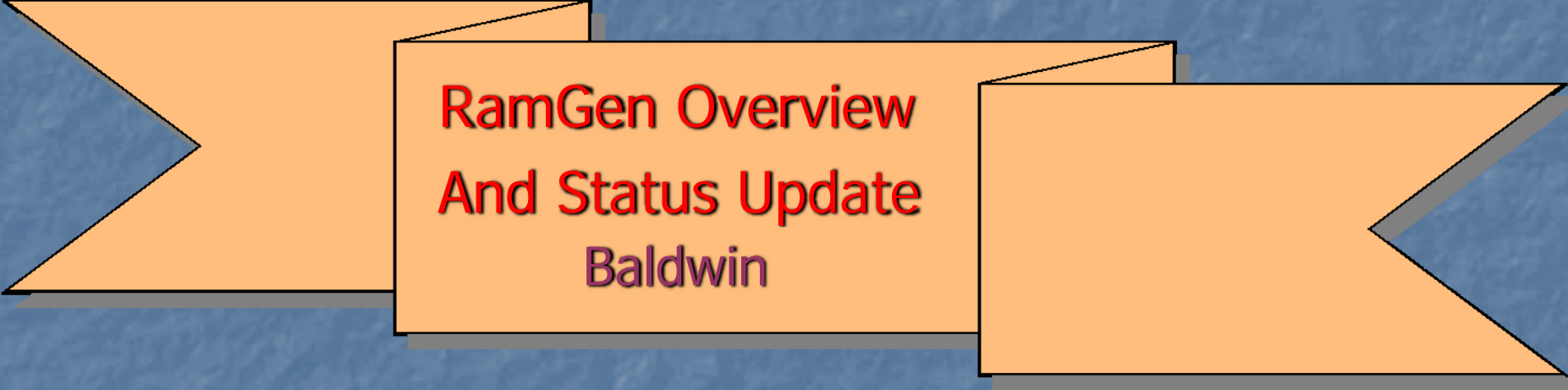

**RamGen Overview  
And Status Update  
Baldwin**

# **Ramgen Power Systems**

## **Workshop on Future Large CO<sub>2</sub> Compression Systems**

**DOE Office of Clean Energy Systems, EPRI, and NIST  
National Institute of Standards and Technology (NIST) Headquarters,  
Gaithersburg, MD 20899  
March 30-31, 2009**



# Forward Looking Statement

---

Some of the information contained in this document contains “forward-looking statements”. In many cases you can identify forward-looking statements by terminology such as “may,” “will,” “should,” “expects,” “plans,” “anticipates,” “estimates,” “predicts,” “potential,” or “continue,” or the negative of such terms and other comparable terminology. Forward-looking statements are only predictions and as such inherently include risks and uncertainties. Actual events or results may differ materially as a result of risks facing Ramgen Power Systems, LLC (“Ramgen”) or actual results differing from the assumptions underlying such statements. These forward-looking statements are made only as of the date of this presentation, and Ramgen undertakes no obligation to update or revise the forward-looking statements, whether as a result of new information, future events or otherwise. Your decision to remain and receive the information about to be presented to you shall constitute your unconditional acceptance to the foregoing.

# Company

---

- **Privately-held R&D company founded in 1992**
- **Focused on unique applications of proven supersonic aircraft technology**
- **Primary technology innovations**
  - **Supersonic stationary air & gas compressors**
  - **High velocity combustor**
  - **Supersonic expander**
- **Product embodiments**
  - **Two-stage 100:1 Pr CO<sub>2</sub> Compressor**
  - **30:1; 42% LHV ASCE Engine**
  - **Airborne APU**
  - **H<sub>2</sub> fuel combustor**



**US Army Corps  
of Engineers**



# Ramgen Compressor Technology

# Shock Waves to Supersonic Inlets

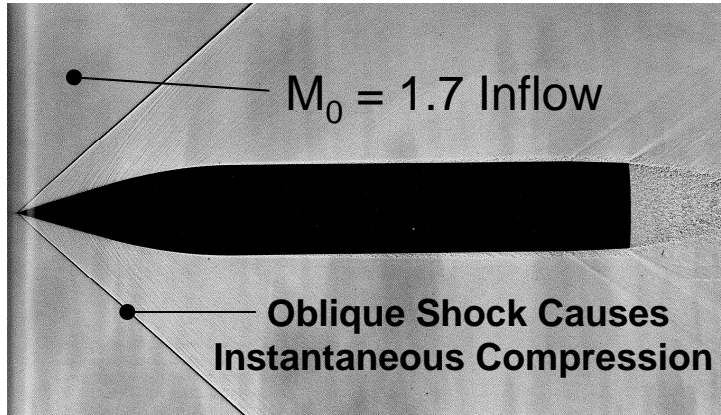

Schlieren Photo of Projectile with Shocks

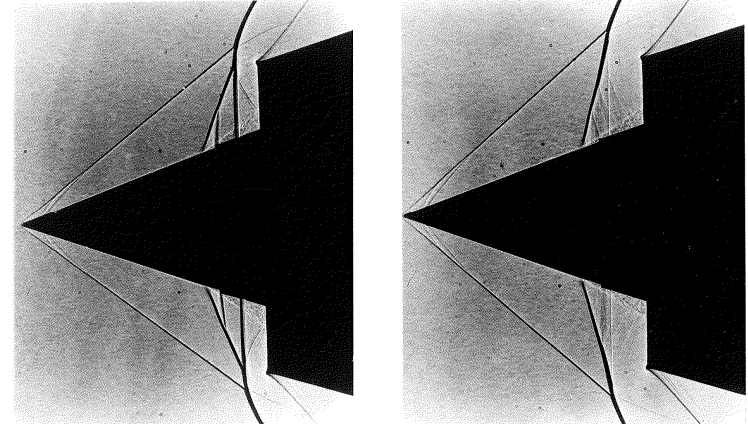

Schlieren Photo of Inlet Center-body and Cowl with Shocks

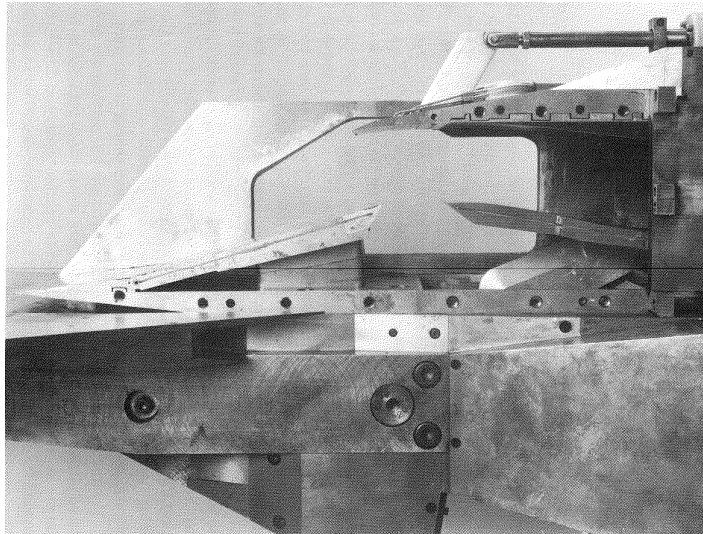

## 2-D Mixed Compression Inlet Model

- Initial External Shock System Followed by Internal Shock System
- Throat Bleed Slot For Inlet Starting
- Side Window For Schlieren Photography

# F-15 2-D Planar Supersonic Inlet

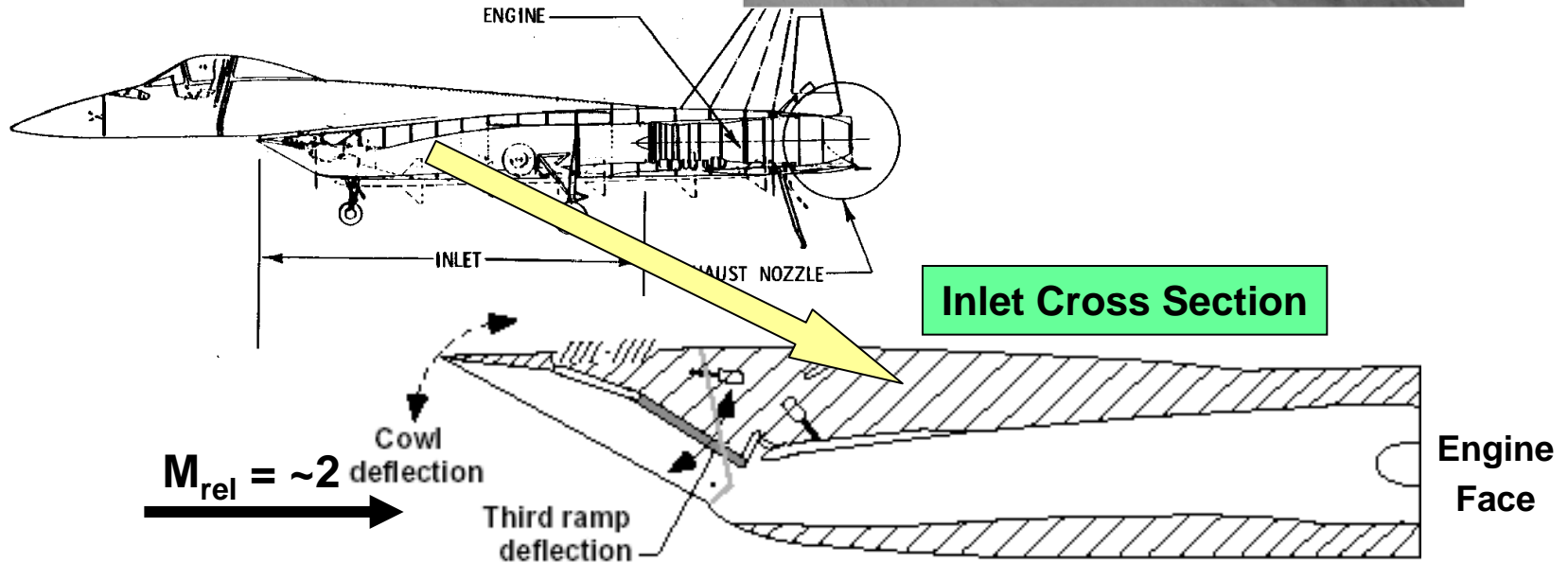

# Rampressor Rotor Development

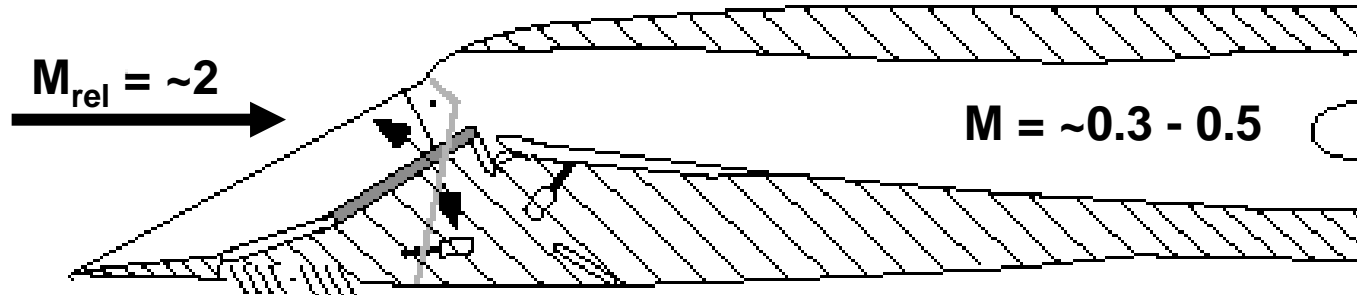

**Supersonic  
F-15 Inlet**

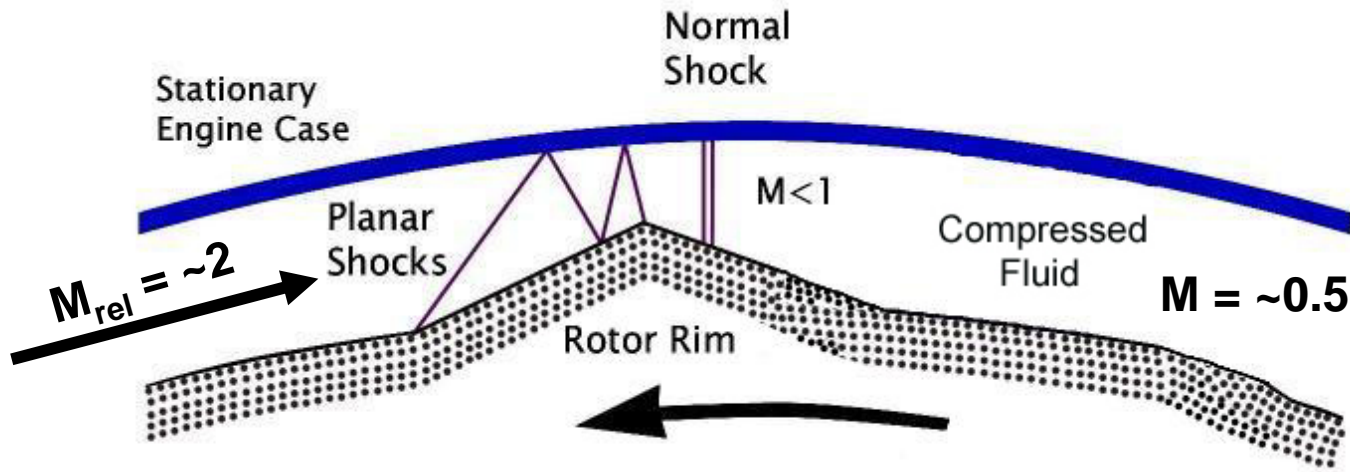
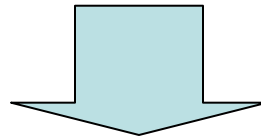

**Rampressor  
Rotor**

# Typical Rotating Supersonic Flow Path

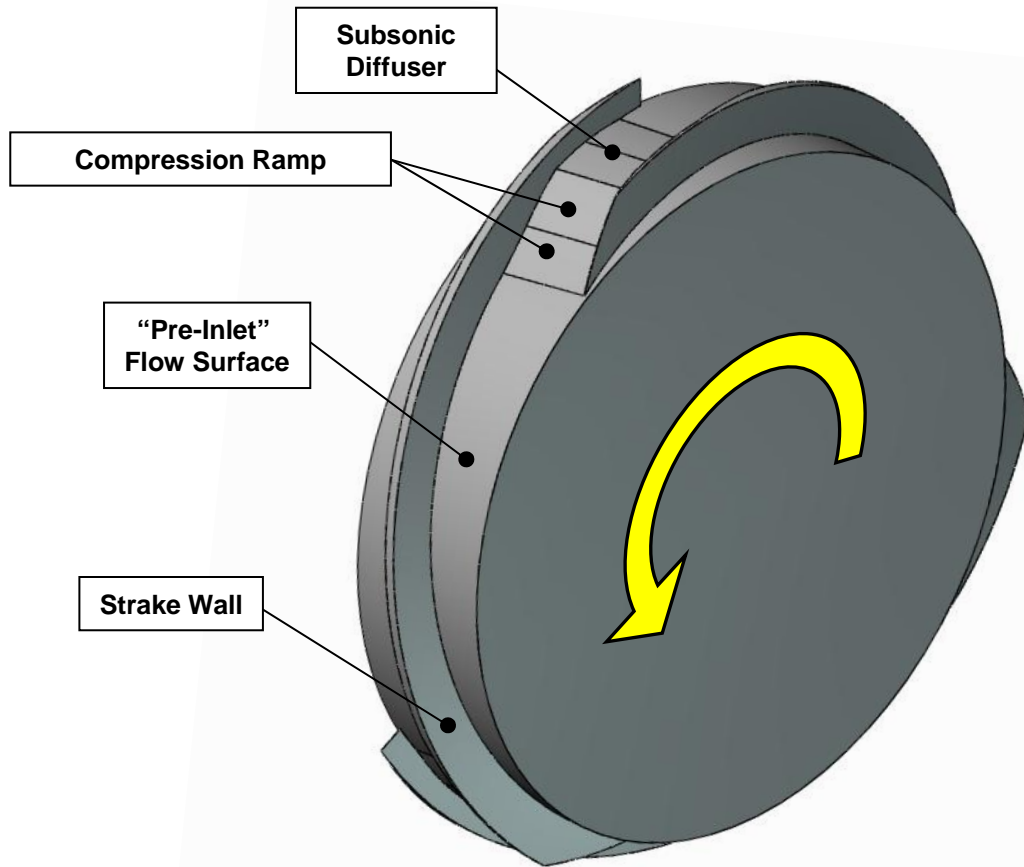

- **Rotor Flow Path:**

- 3 Supersonic Compression Inlet Flow Paths On Disk Rim
- High Efficiency, Compact Compression
- Minimal Number of Leading Edges
- Flow Path Geometry Similar For Different Pressure Ratios

- **Combination of Supersonic Flight Inlet & Conventional Axial Flow Compressor Aerodynamics:**

- Rotor Rim Radius Change Produces Compression
- 3 “Blades” (Strakes) Do Minimal Flow Work
- Axial Inflow/Outflow

# Compression Applications vs. Pr/Tip Speed

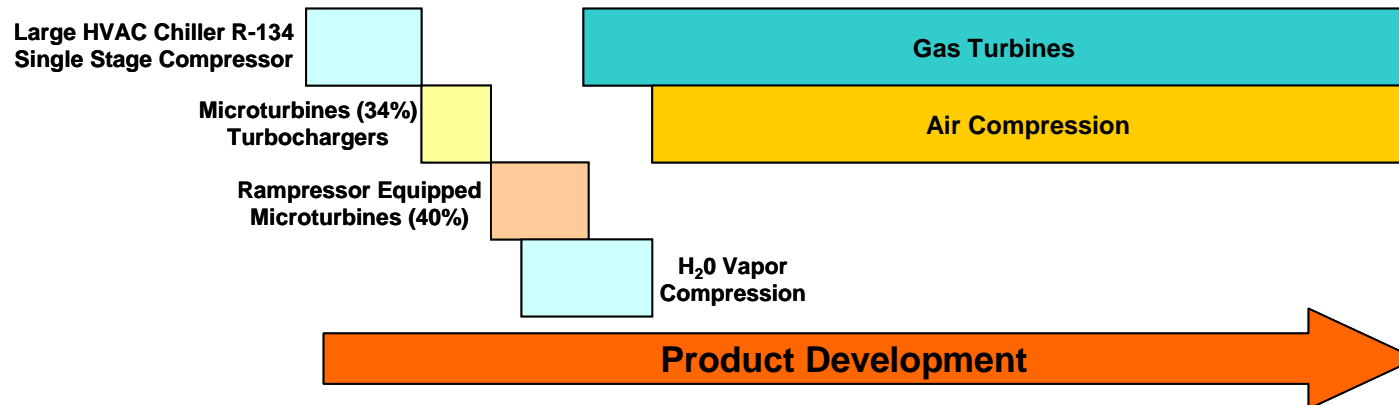
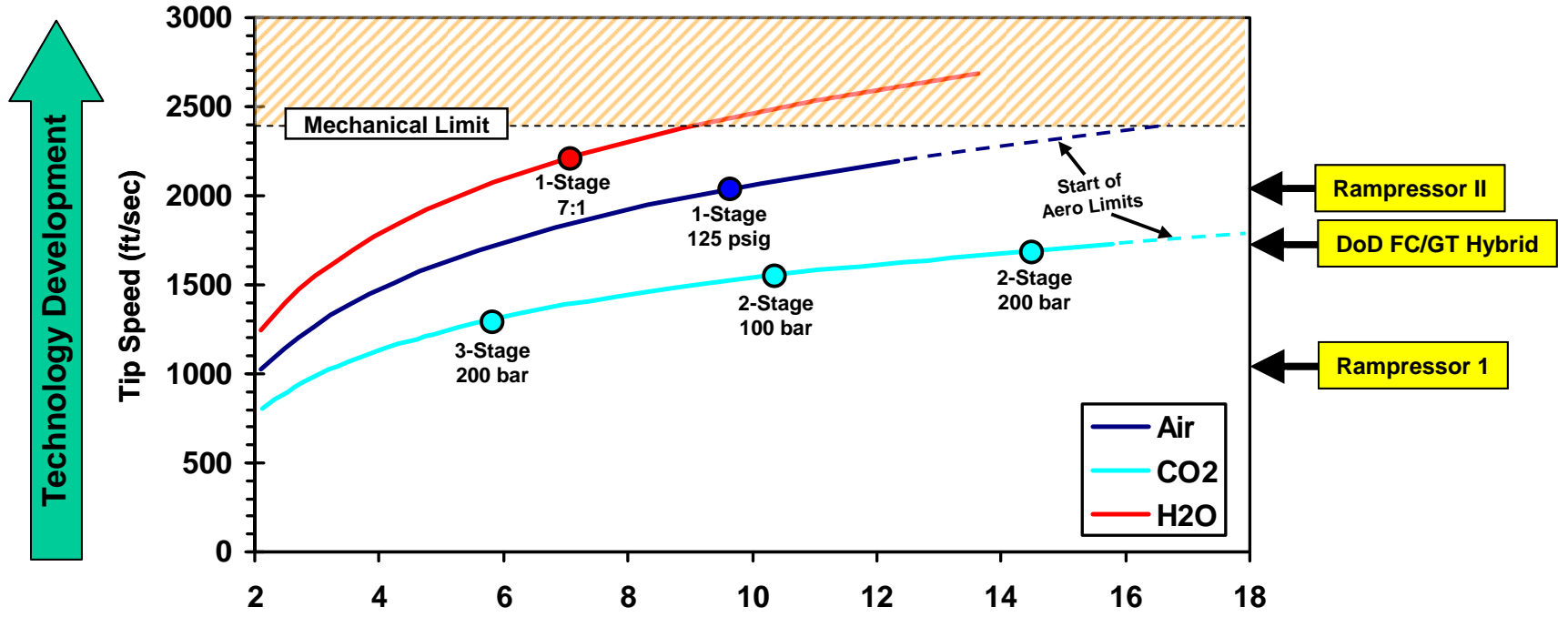



# Enter Dresser-Rand

# Dresser-Rand Invests in Ramgen

---

- **Dresser-Rand invests in Ramgen’s “game-changing technology”**
  - Support on-going CO2 compressor development
  - Satisfy DOE matching funds requirement
  - Consistent with strategy to be technology leader in our industry
  - Extend served market into Electric Utility industry
  - Invest up to \$49 million
    - Fund development & demonstration
    - Obtain an option to purchase assets

**Dresser-Rand is consistently ranked among top three manufacturers in its served markets**

- Turbomachinery
- Reciprocating compressors
- Steam turbines
- **#1 in North America**
- **Leading supplier of CO2 compressors**
- **Global sales & service presence**
- **Strong products & brands**
- **Established customer base**

# Dresser-Rand Historical Overview

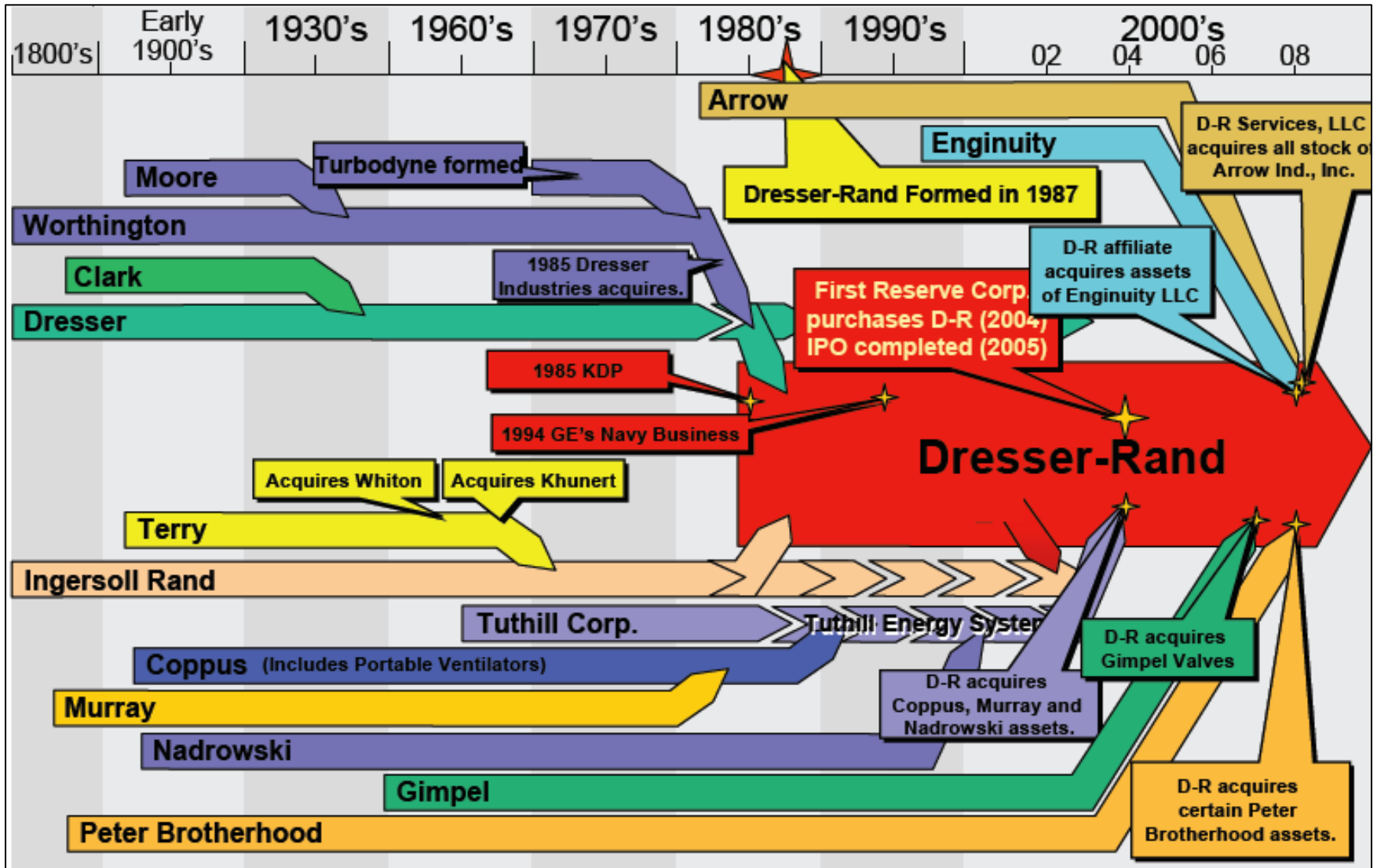

# Dresser-Rand Heritage



**DRESSER-RAND.**

*Serving the energy markets since 1840*

# Dresser-Rand's Global Presence

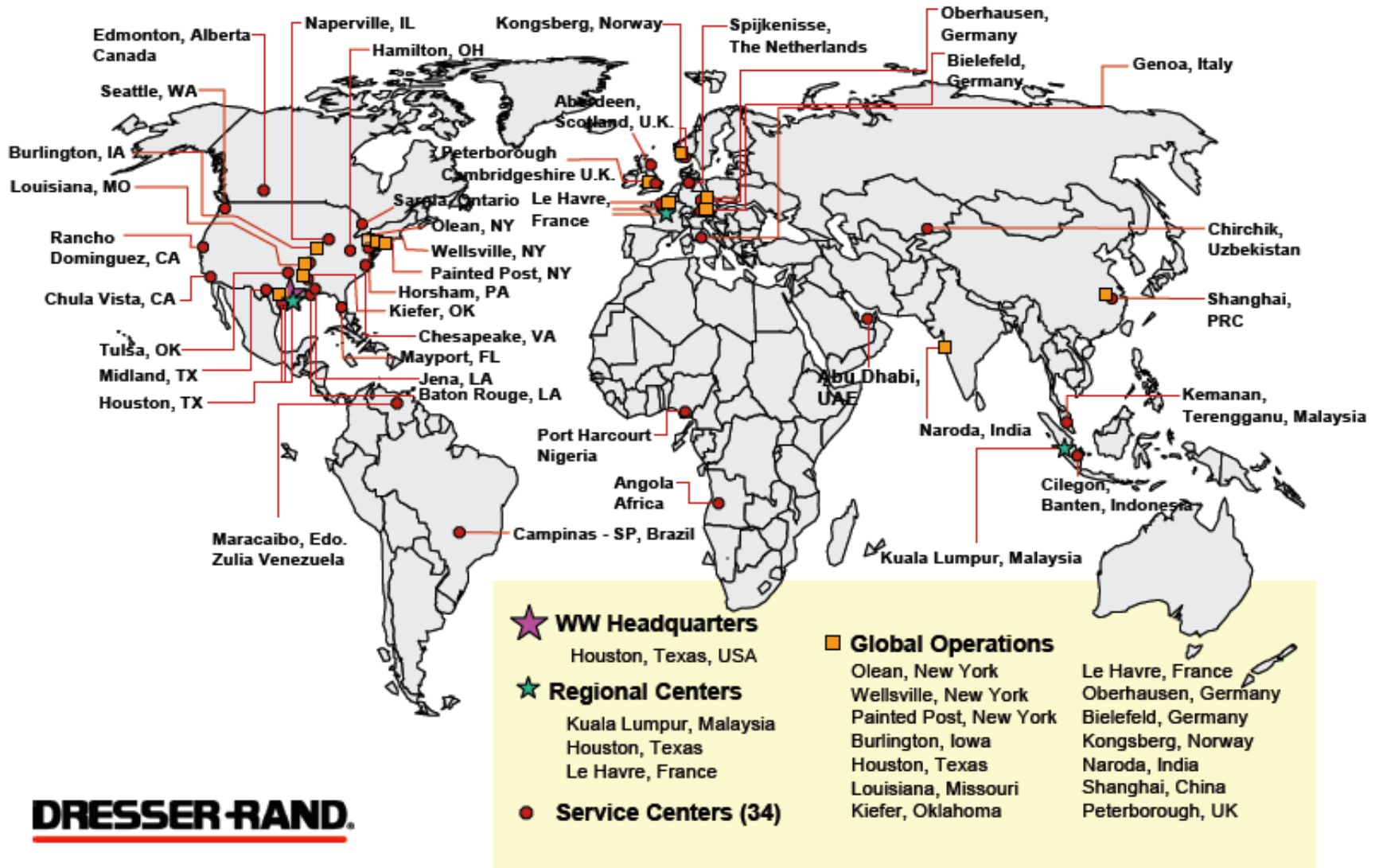

**DRESSER-RAND.**

# Dresser-Rand Key Clients



**DRESSER-RAND.**

Note: Partial list as of December 2007.

# Products for All Served Markets

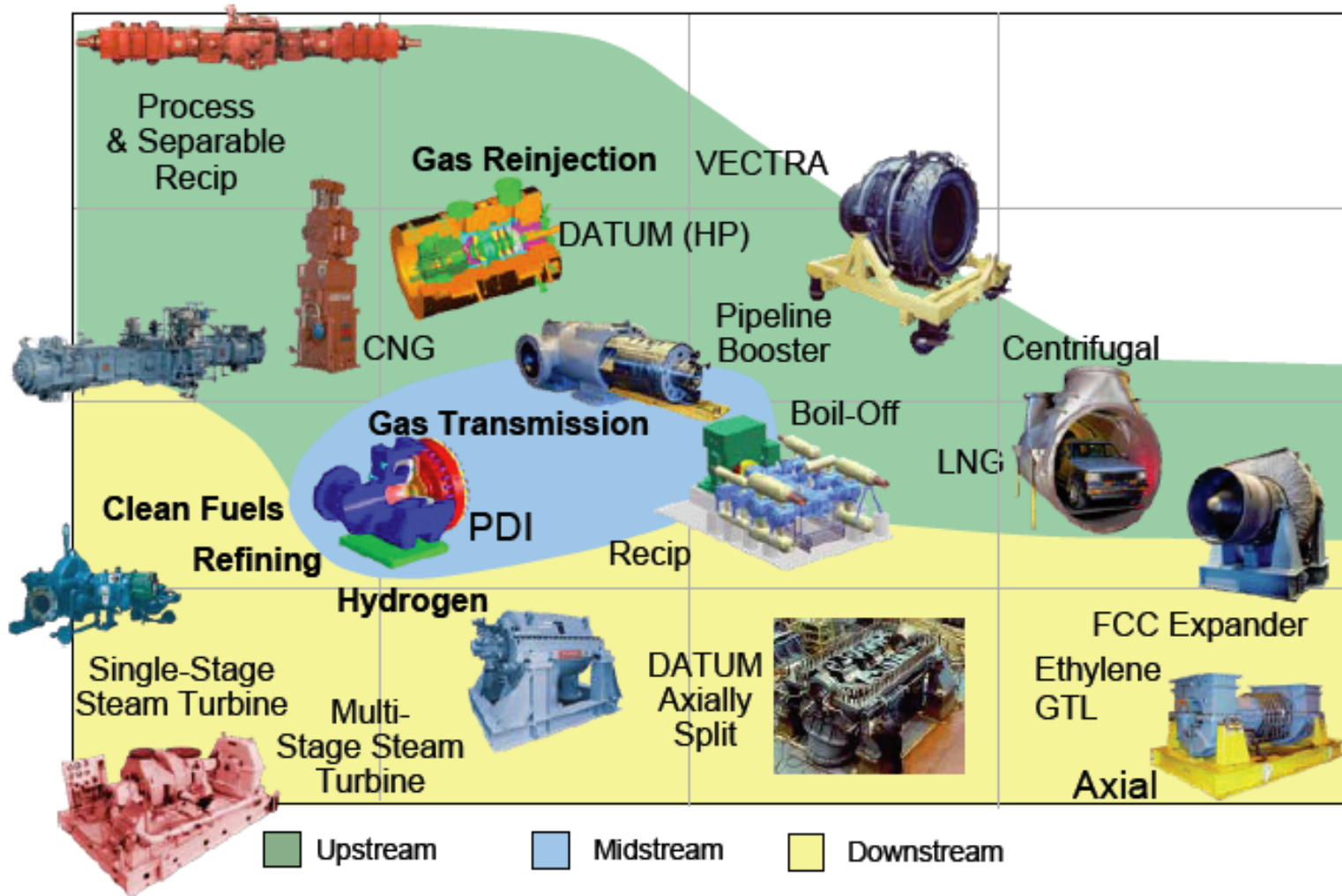

**DRESSER-RAND.**

# World Class Test Facilities

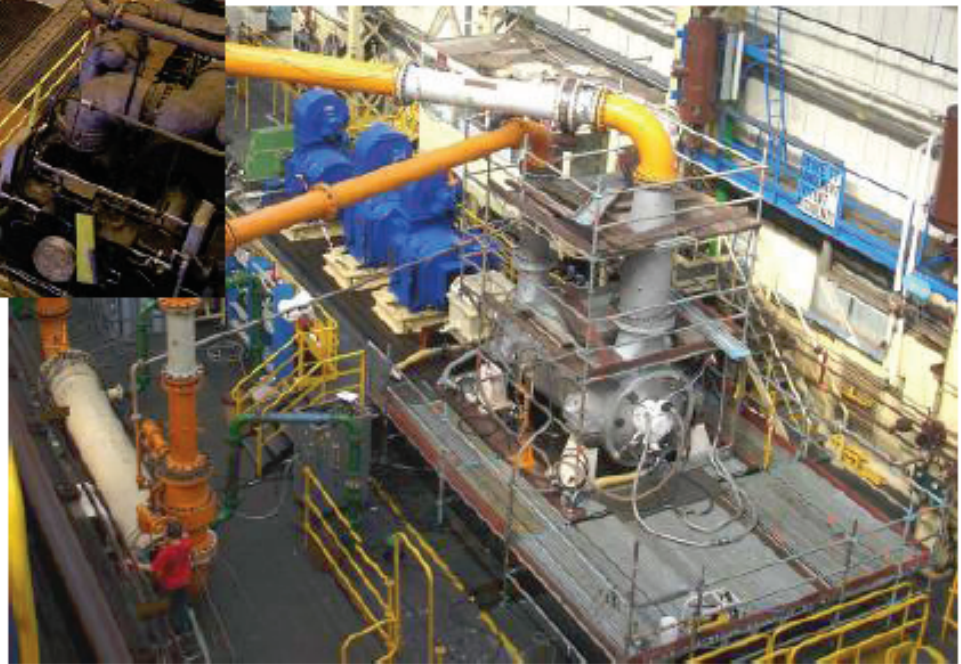

**DRESSER-RAND.**



# Ramgen CO<sub>2</sub> Compressor Product

- **100:1 CO<sub>2</sub> compressor** ⇒ 2-casings/2-stages/Intercooled
  - No aero Mach# limit
  - 10+:1 pressure ratio; 400°F temperature rise
  - 1400 fps tip speeds; Shrouded rotor design
- **Single-stage, discrete-drive**
  - Single stage per drive optimizes specific speed match
  - Simple single-step external gearbox or high speed direct drive
  - Lower mechanical losses
- **Variable speed option**
  - Match MW and temperature changes with speed changes
- **Configuration adapts easily to match process requirement:**
  - Mismatched thru-flow
  - Side stream additions
- **Active IGV Flow control on each stage**
  - Match CO<sub>2</sub> capture system constant pressure requirement
- **Heat exchangers**
  - Inter/aftercooler can be the CCS or power plant
  - “Compressor” heat exchanger cost can be eliminated
  - Eliminate or substantially reduce cooling tower requirement
  - Eliminate or substantially reduce cooling tower make-up water
  - 3x LMTD ⇒ heat exchangers with 1/3 the surface area
- **1/10th the physical size** – facilitate space constrained retrofits
- **1/2 the installation cost**

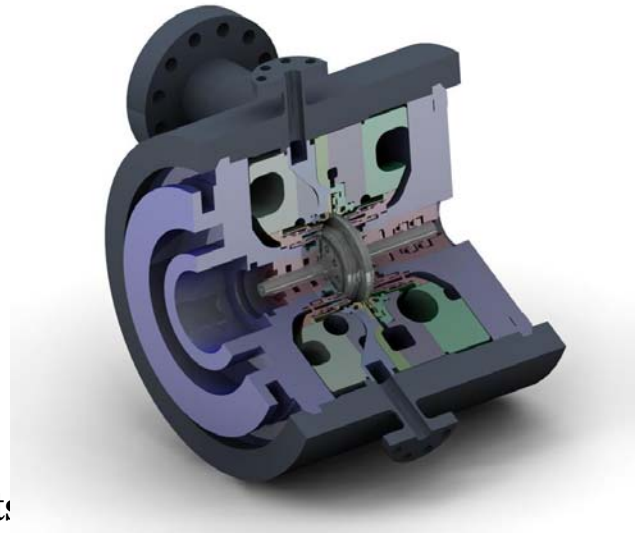

Ramgen Discrete Drive HP Stage

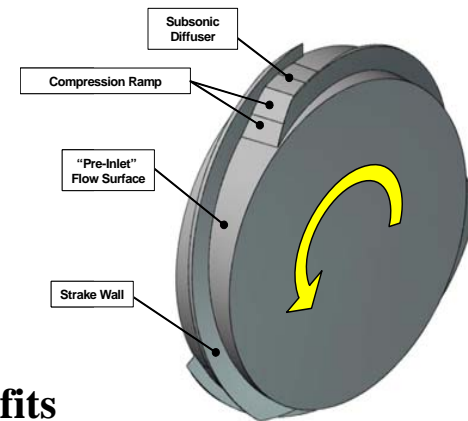

Ramgen Compressor Rotor

# Compressed Air & Gas Handbook

can be handled with sufficient accuracy for most purposes when the unit is a typical single-stage air compressor. A little more discretion must be used on multistage compressors handling heavy gases, however, because fan-law deviation can become quite significant for speed changes as small as 10 per cent.

### Choke Effect

The basic slope of the head flow curve has been discussed at some length, but the choke or stonewall effect that occurs at flows higher than design flow and which must be superimposed upon the basic slope (Fig. 11.19) has not yet been discussed.

Just as basic slope is controlled by impeller-tip vector geometry, the stonewall effect is normally controlled by impeller-inlet vector geometry. In Fig. 11.24, vector  $U_1$  may be drawn to represent the tangential velocity of the leading edge of the blade similar to that of the inlet flow. The angle between  $U_1$  and the radial direction is similar to that of the inlet flow. The angle between  $U_1$  and the radial direction is similar to that of the inlet flow. The angle between  $U_1$  and the radial direction is similar to that of the inlet flow.

**...it is conventional practice to limit the Mach# to 0.85 or 0.90 at design flow.**

### Mach Number Considerations

The magnitude of  $V_{rel}$  compared to the speed of sound at the inlet pressure and temperature is called the relative inlet Mach number. It is the magnitude of this ratio that indicates stonewall effect in a conventional stage. While true stonewall effect should theoretically not be reached until the relative inlet Mach number is unity, it is conventional practice to limit the Mach number to 0.85 or 0.90 at design flow.

It is evident from Fig. 11.24 that, for a given rpm, the magnitude of  $V_{rel}$  will diminish with decreasing flow, since  $V$  is proportional to flow. If  $V_{rel}$  decreases, then relative inlet Mach number decreases, so the stonewall effect is normally not a factor at flows below design flow. It is also evident that at low flows the direction of  $V_{rel}$  is such that the gas impinges on the leading side of the blade, resulting in positive

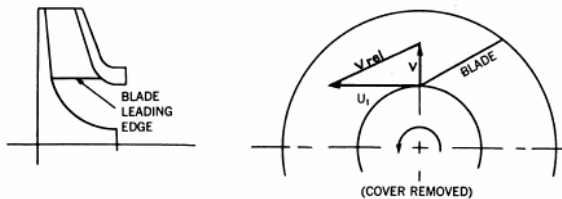

Figure 11.24 Impeller inlet geometry and velocity diagram.

incidence, a factor of positive incidence.

Let us now do  $V_{rel}$  and relative side of the blade, high degrees of negative incidence tend to contribute to the stonewall problem as Mach number 1.00 is approached, presumably because of boundary layer separation and reduction of effective flow area in the blade pack.

$$c = \sqrt{kg \bar{R} T / MW}$$

### Significance of Gas Weight

Since values of  $U_1$  are typically in the 500-fps (152.4-m/second) range and values of  $V$  in the 250-fps (76.2 m/second) range, it is obvious that, since the speed of sound for air at 80 deg. F (26.7 deg. C) is 1140 fps (348 m/second), lighter gases suffer no true impeller stonewall problems as described, even at high overloads. Some head loss below the basic slope will be observed, however, in even the lightest gases, due in part to increased frictional losses throughout the entire stage and in part to the extreme negative incidence at high overloads.

The lightest common gas handled by conventional centrifugal compressors for which stonewall effect can be a definite factor is propylene with a sonic speed of 740 fps (225.7 m/second) at -40 deg. F (-40 deg. C). In order of increasing severity are propane at 718 fps (219 m/second) at -40 deg. F (-40 deg. C), butane at 630 fps (192.1 m/second) at -20 deg. F (-29 deg. C), chlorine, and the various Freons. The traditional method of handling such gases is to use an impeller of larger than normal flow area to reduce  $V$ , and run it at lower than normal rpm to reduce  $U_1$ , thus keeping the value of  $V_{rel}$  abnormally low. This procedure requires the use of more than the usual number of stages for a given head requirement and sometimes even requires the use of an abnormally large frame for the flow handled.

### Inducer Impeller Increases Head Output

Much development work has been done in recent years toward the goal of running impellers at normal speeds on heavy gases in order to reduce hardware costs to those incurred in the compression of light gases. One approach has been to use inducer impellers (Fig. 11.25). The blades on this impeller extend down around the hub radius so that the gas first encounters the blade pack while flowing axially. Figure 11.25 shows the vector analysis at the inducer outer radius. Assuming that the inducer radius is the same as the leading edge radius of the conventional radial inlet impeller, the vector geometries of the two are identical.

The advantage of the inducer lies in the fact that, as we move radially inward along the blade leading edge, the value of  $U_1$ , and therefore of  $V_{rel}$  and Mach number, decreases. As we move along the leading edge of the conventional impeller, the vector geometry remains essentially constant. It can be seen, therefore, that while maximum Mach number for the two styles is the same, the average Mach number for the inducer

# Technology Development Needs & Direction

# Fossil Fuel Power Plant – CC&S

- All fossil fuel power plants produce some level of CO<sub>2</sub>
- CO<sub>2</sub> compressor power
  - Advanced pulverize coal – 8-12%
    - 600MW ⇒ 70MW ⇒ 93,000 hp
  - IGCC - 5%
    - 600MW ⇒ 30MW ⇒ 40,000 hp
  - CCGT – 8%
    - 400MW ⇒ 32MW ⇒ 43,000 hp
- 100 new power plants annually
  - \$1.5 billion annual compressor market
- Retrofit opportunity
  - \$0.7 billion annual compressor market

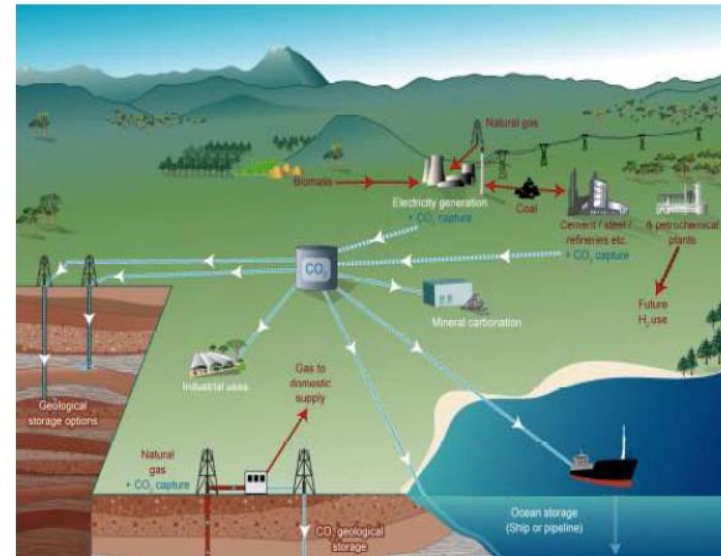
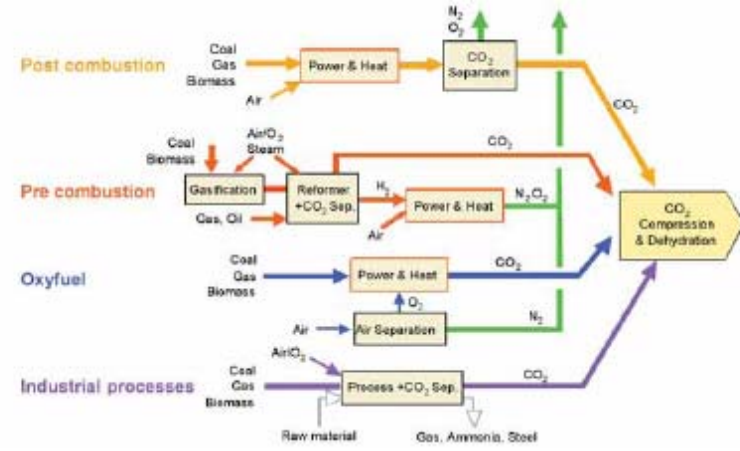

**Over \$2 Billion annual market opportunity**

- **Amine systems**
  - Suction pressures – 15; 22; 25; 30 psia
  - Regeneration heat required
    - Conventional amines – 1550 Btu/lbm-CO<sub>2</sub>
    - Advanced amines – 1200 Btu/lbm-CO<sub>2</sub>
    - Really advanced amines – 800 Btu/lbm-CO<sub>2</sub>
  - 8% parasitic power
  - Post combustion - New & Retrofit
- **Ammonia-based systems**
  - Suction pressures – ~ 30-300 psia
  - Regeneration heat required
    - Aqueous ammonia – 493 Btu/lbm-CO<sub>2</sub>
    - Chilled ammonia – TBD
  - 4% parasitic power
  - Post combustion - New & Retrofit
- **Chemical Looping**
  - Suction pressure atmospheric
- **Selexol/Rectisol**
  - Suction pressures 50, 150 & 300 psia with sidestreams
  - Regeneration heat required for the Claus Plant
  - 5% parasitic power
  - IGCC (new) only
- **Oxy-fuel systems**
  - Raw gas feed – 15 to 500 psia
  - Twin purified suction streams – ~150 & 300 psia
  - 12-13% parasitic power
  - New plants only
- **Membrane Separation & Enzyme Processes**
  - Suction pressures from <3.0-14.7 psia
- **Discharge pressures – 1200;1600; 2000; 2215; 2500; 2700; 2900 psia**

# Baseline Case for Comparison

## Data Provided

- Case 3 ASME TurboExpo Berlin - June 2008
- Case 12 in the Baseline Cost & Performance Study – May 2007
- Compressor 6-stage integrally geared design
- 84% isentropic efficiency all stages
- Inlet conditions 23.52 psia; 69°F inlet temperature; 92.4% RH
- Discharge conditions 2215 psia
- Cooling water 60°F
- Stage pressures
- 1,259,600 lbm/hr
- 2 units

## Assumptions

- Intercooler approach temperature 9°F
- Interstage pressure drop  $DP = (P2^{0.7})/10$  ; but not greater than 5 psi
- Mechanical loss 1.5%
- Drying between stages 3 & 4
- Partial cooling between stages 5 & 6
- 46,900kW Published (2 unit total)
- 46,898kW Calculated with these assumptions

	Stage					
	1	2	3	4	5	6
<b>P1 - psia</b>	<b>23.52</b>	<b>52.00</b>	<b>113.01</b>	<b>248.00</b>	<b>545.00</b>	<b>1200.00</b>
<b>T1 - °F</b>	<b>69</b>	<b>69</b>	<b>69</b>	<b>69</b>	<b>69</b>	<b>100</b>
<b>P2 - psia</b>	<b>53.65</b>	<b>115.80</b>	<b>253.00</b>	<b>550.00</b>	<b>1205.00</b>	<b>2219.99</b>
<b>Pr</b>	<b>2.23</b>	<b>2.28</b>	<b>2.24</b>	<b>2.22</b>	<b>2.21</b>	<b>1.85</b>

**Baseline case needs realistic assumptions**

# It's No Fun Being Overlooked!

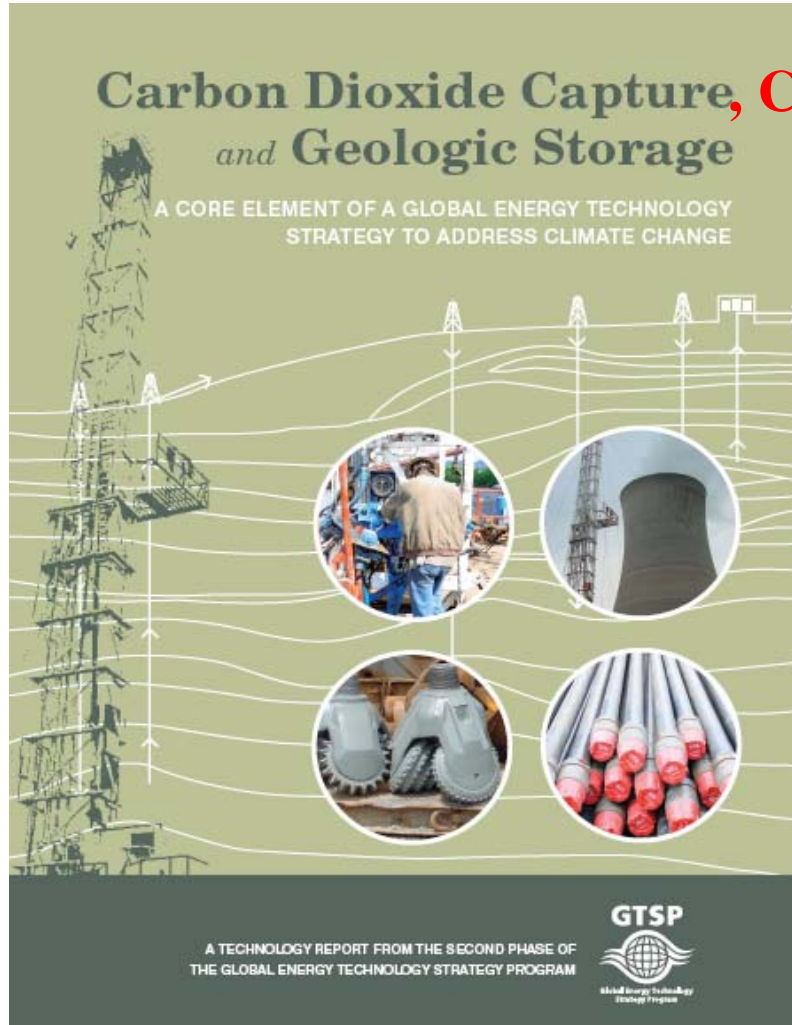

**Compression**

# Immaculate Compression

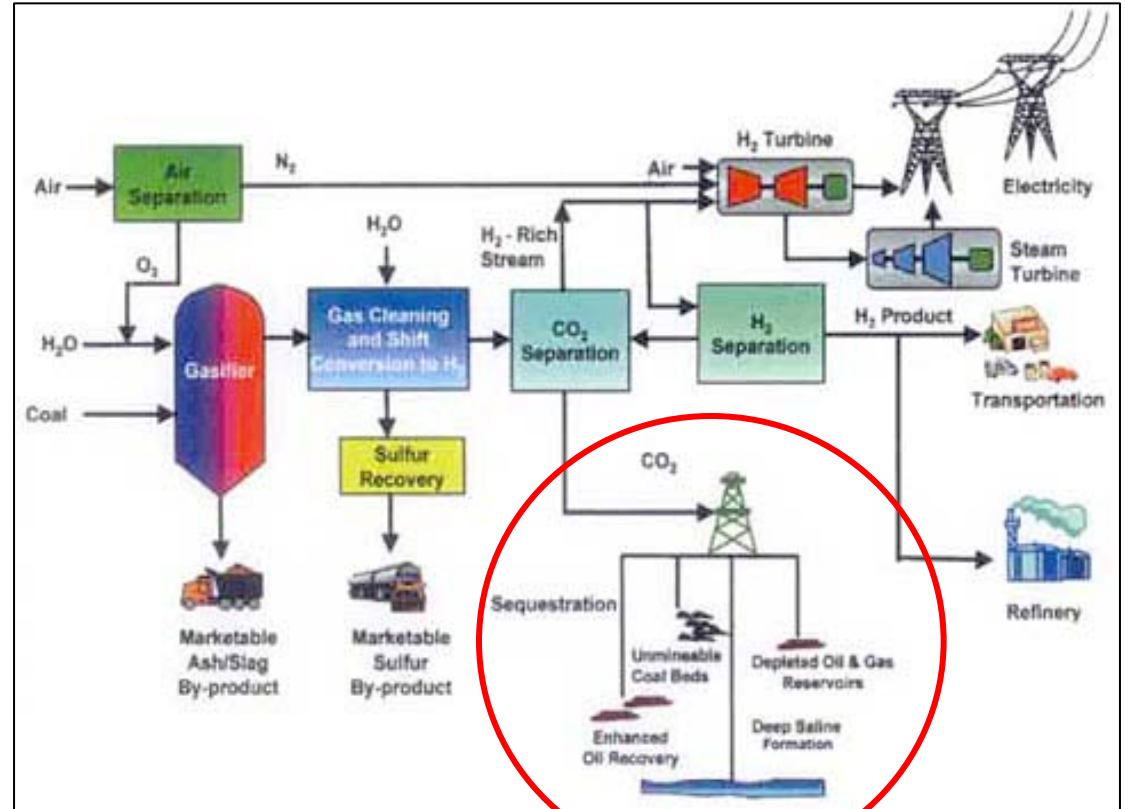

**Sequestration**



# Compressor Power & Things That Affect It

- **The basic inputs**
  - Gas composition, including moisture content
  - Mass flow
  - Inlet pressure
  - Inlet temperature
  - Discharge pressure
- **Often forgotten**
  - Cooling media & temperature
    - Air
    - Water-cooled
    - Process cooled
  - Interstage assumptions
    - Pressure drop
    - Design practice
    - Fluor estimate  $\Delta P = P_2^{0.7}/10$ ; not to exceed 5 psi
    - Intercooler/heat exchanger approach temperature or Cold Temperature Difference – CTD
    - 15°F CTD normal approach temperature
  - Mechanical losses
    - Compressor
    - Gearbox
  - Sparing philosophy (i.e., 2 x 50% + 1)

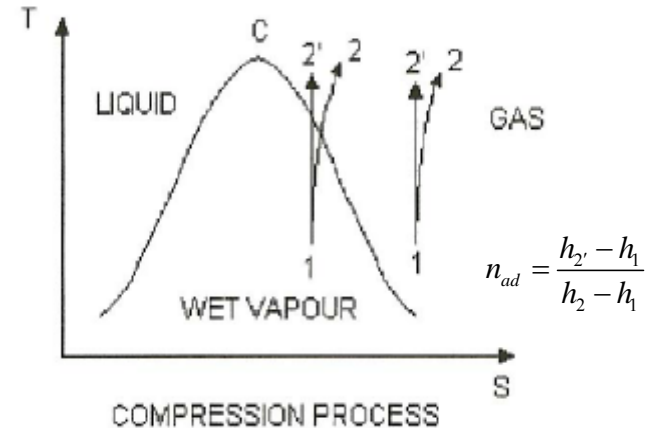

- **CCS Application Specific Issues**
  - Capture system flash levels & control requirements
    - Pressure
    - Mass flow additions
  - Water knockout
    - Process location (i.e., pressure)
    - Method – Glycol/Molecular sieve/PSA
  - CO2 compressor inlet pressure
  - Heat integration
  - Materials of construction
    - Heat exchangers
    - Piping
  - Discharge pressure

Only the first stage is affected by the inlet conditions....all the other stages are affected by interstage assumptions.

# Heat Exchangers are a Big Deal!



MAN Turbo

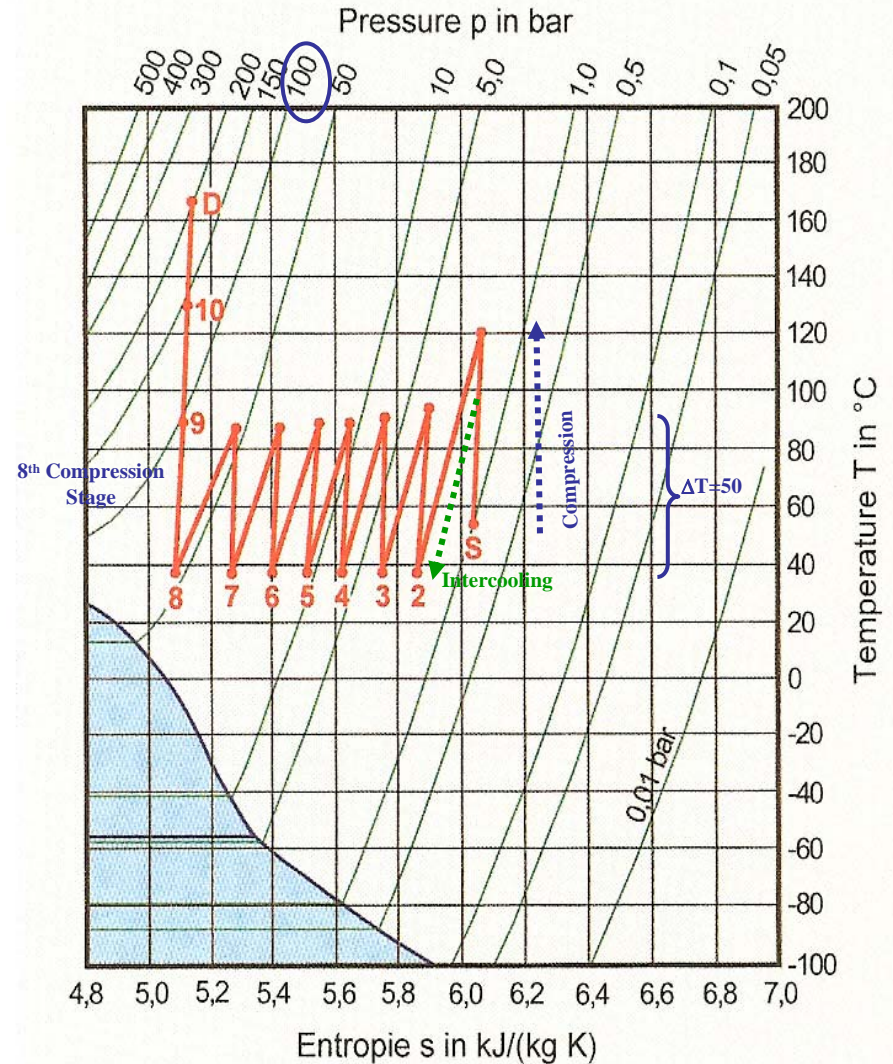

# Retrofit Capture Cost Assumptions

## • “Carbon Dioxide Capture from Existing Coal-Fired Power Plants”

- DOE/NETL 401/110907 – Revised November 2007
- AEP/Alstom Conesville Unit #5
- Base line & Case 1

## • Process Conditions

- P1 19 psia
- T1 115 F
- P2 2015 psia
- Illinois #6 @ 1.80/mmBtu
- 90% capture
- 85% capacity factor

## • Financial Assumptions

- Make-up power 6.4 cents/kWh
- Burden rate 2.28

## • Baseline Compressor Horsepower

– CO2 compressor	31,262
– Propane refrigeration	23,321
– CO2 product pump	<u>2,932</u>
<b>Total</b>	<b>57,515 hp</b>
– Compressor only equivalent	56,800
– Analysis	56,800 hp

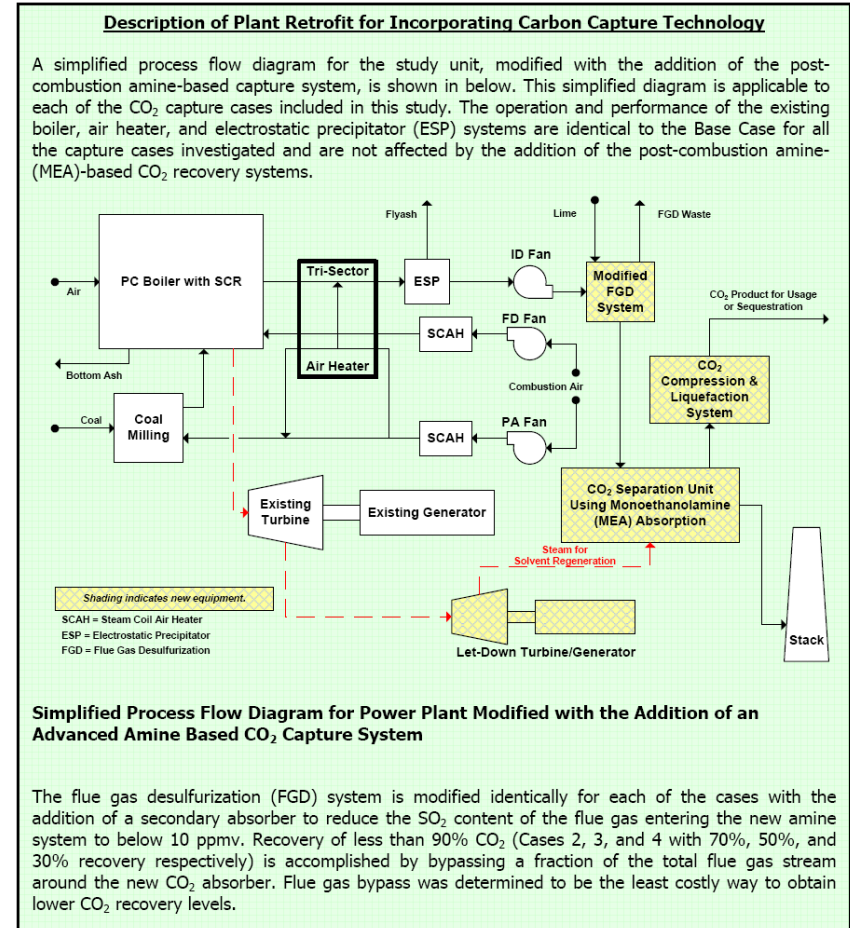

# Conventional CO<sub>2</sub> Compression

- **CO<sub>2</sub> compressor power**
  - Advanced pulverize coal – 9.1%
  - 463MW ⇒ 42MW ⇒ 56,800 hp
  
- **Capital Cost for 56,800 hp**

– 2 x 50% operating units @ \$1000/hp	57
– 1 x 50% spare	28
– Burdened Installation cost	<u>109</u>
– Total Cost	<b>\$194M</b>
– \$194M/303MW =	<b>\$640/kW</b>
  
- **Cost of Electricity (COE)**

– Baseline w/o CCS	6.07
– Capture system	4.74
– Compressor	<u>2.70</u>
– Total cents/kWh	<b>13.51</b>
– Increase in COE for CCS	<b>122%</b>
  
- **Cost per tonne**

– Capture system	41
– Compressor	<u>23</u>
– Total	<b>\$64</b>

- **Heat recovery – Btu/lbm-CO<sub>2</sub>**

– Regeneration Heat	1548
– Heat recovery	<u>0</u>
Net Btu/lbm-CO <sub>2</sub>	<b>1548</b>
  
- **Plant output**

– Original rating	463
– De-rating @ 1548 Btu/lbm	<u>160</u>
– Net	<b>303 MW</b>
– Value @ 6.4 cents/kWh	<b>\$62M/year</b>

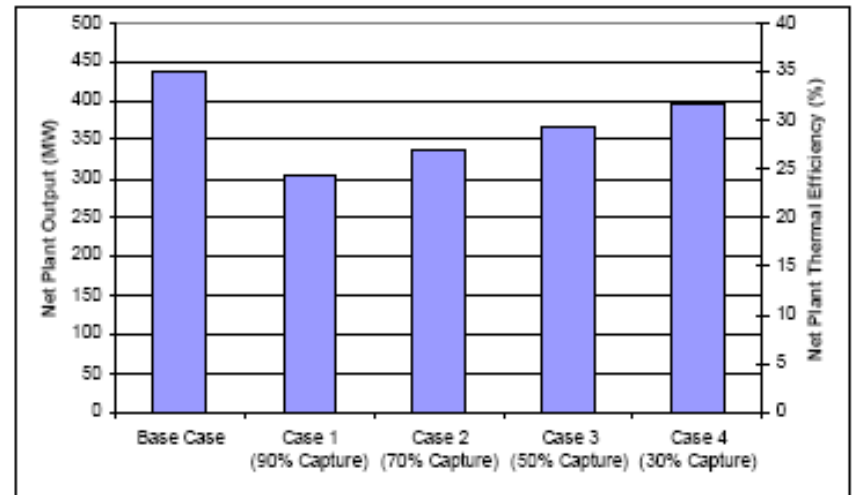

Figure ES-3: Plant Performance Impact of Retrofitting a Pulverized Coal-Fired Plant at Various Levels of Carbon Capture

**Compression Costs are 36% of Total Cost/Mt of CO<sub>2</sub>**

# Ramgen CO<sub>2</sub> Compression w/Advanced CCS

- **CO2 compressor power**
  - Advanced pulverize coal – 4.2%
  - 463MW ⇒ 20MW ⇒ 26,000 hp
  
- **Capital Cost for 26,000 hp**

– 2 x 50% operating units @ \$400/hp	11
– 1 x 50% spare	5
– Installation cost	<u>20</u>
– Total Cost	\$36M
– \$36M/388MW =	\$93/kW
  
- **Cost of Electricity (COE)**

– Baseline w/o CCS	6.07
– Capture system	2.02
– Compressor	<u>0.47</u>
– Total cents/kWh	8.56
– Increase in COE for CCS	41%
  
- **Cost per tonne**

– Capture system	22
– Compressor	<u>5</u>
– Total	\$28

- **Heat recovery – Btu/lbm-CO<sub>2</sub>**

– Regeneration Heat	450
– Heat recovery @ 230F	<u>93</u>
– Net Btu/lbm-CO <sub>2</sub>	357
– HR potential @ 100F	87
  
- **Plant output**

– Original rating	463
– De-rating @ 450 Btu/lbm	<u>75</u>
– Net	388 MW
– Value @ 6.4 cents/kWh	\$22M/year

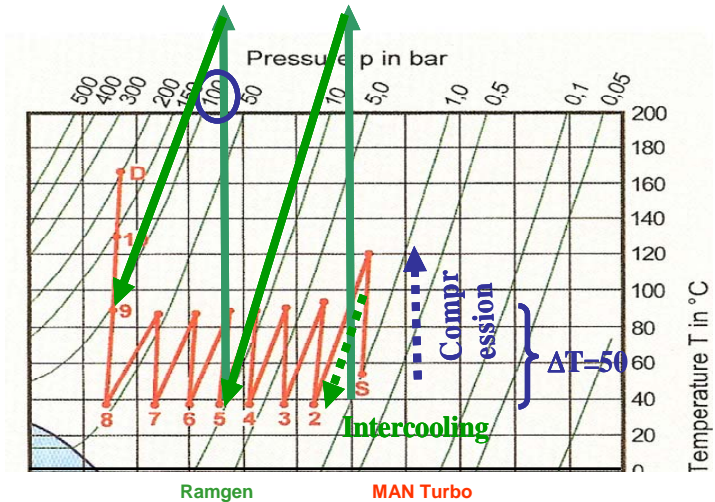

**CC&S cost can be reduced by 56% from \$64 to \$28/tonne CO<sub>2</sub>**

# PT Diagram & Supercritical Phase

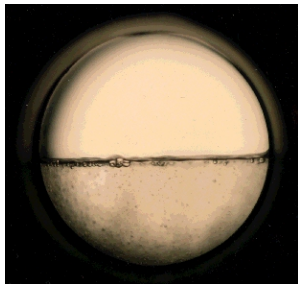

*Separate Phases  
Visible-  
Meniscus Clearly  
Observed*

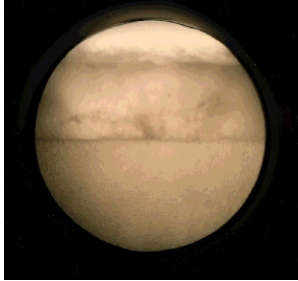

*Increase in  
Temperature-  
Diminished  
Meniscus*

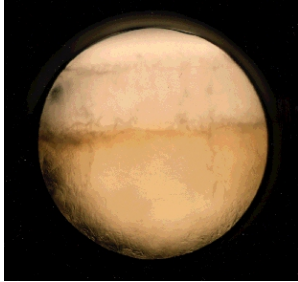

*Further Increase in  
Temperature-  
Gas & Liquid  
Densities more Similar*

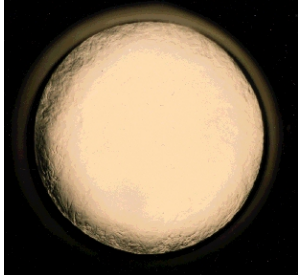

*At Critical P & T-  
Distinct Gas & Liquid  
Phases no Longer  
Visible "Supercritical  
Fluid" with Properties  
of Both Liquids & Gases*

- Compression process transitions from superheated to supercritical phases
- Avoids liquid (sub-cooled) phase

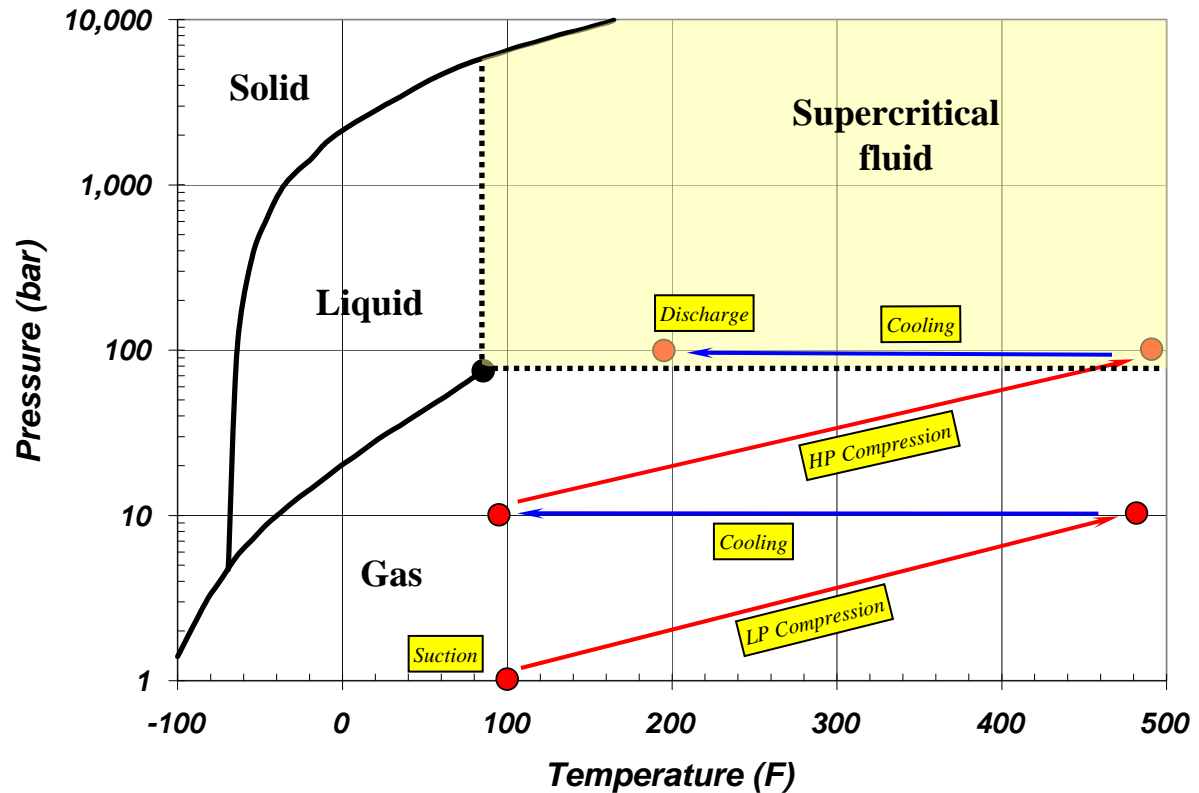

# Ramgen Heat Recovery

	Low Pressure Stage 22 - 220 psia	High Pressure Stage 220 - 2200 psia
Compressor Shaft Input Work	90.6 Btu/lbm	87.0 Btu/lbm
Discharge Temperature	489 °F	509 °F
Lower Recovery Temperature	100 °F	100 °F
Recovered Heat	92.4 Btu/lbm	178.8 Btu/lbm
Recovered Heat/Compression Work	102%	205%

- Heat available in the HP hot discharge CO<sub>2</sub> is more than double the compressor shaft work
- 153% of the combined LP + HP shaft work is available as heat in the discharge CO<sub>2</sub>

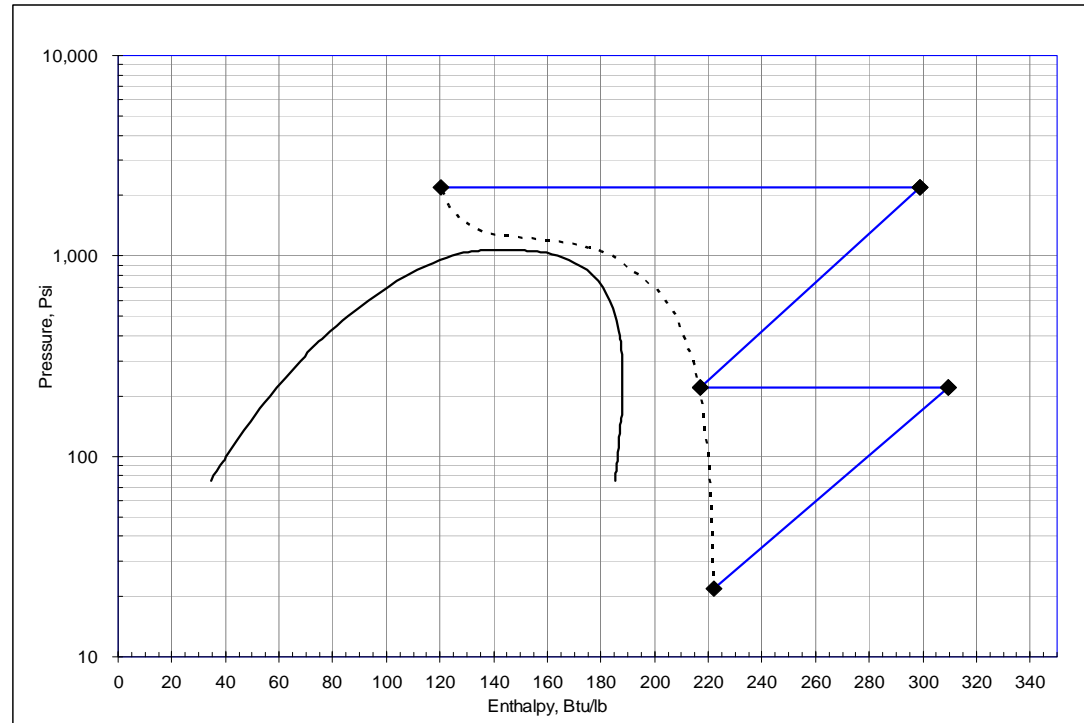

# Optimizing Compressor Selection

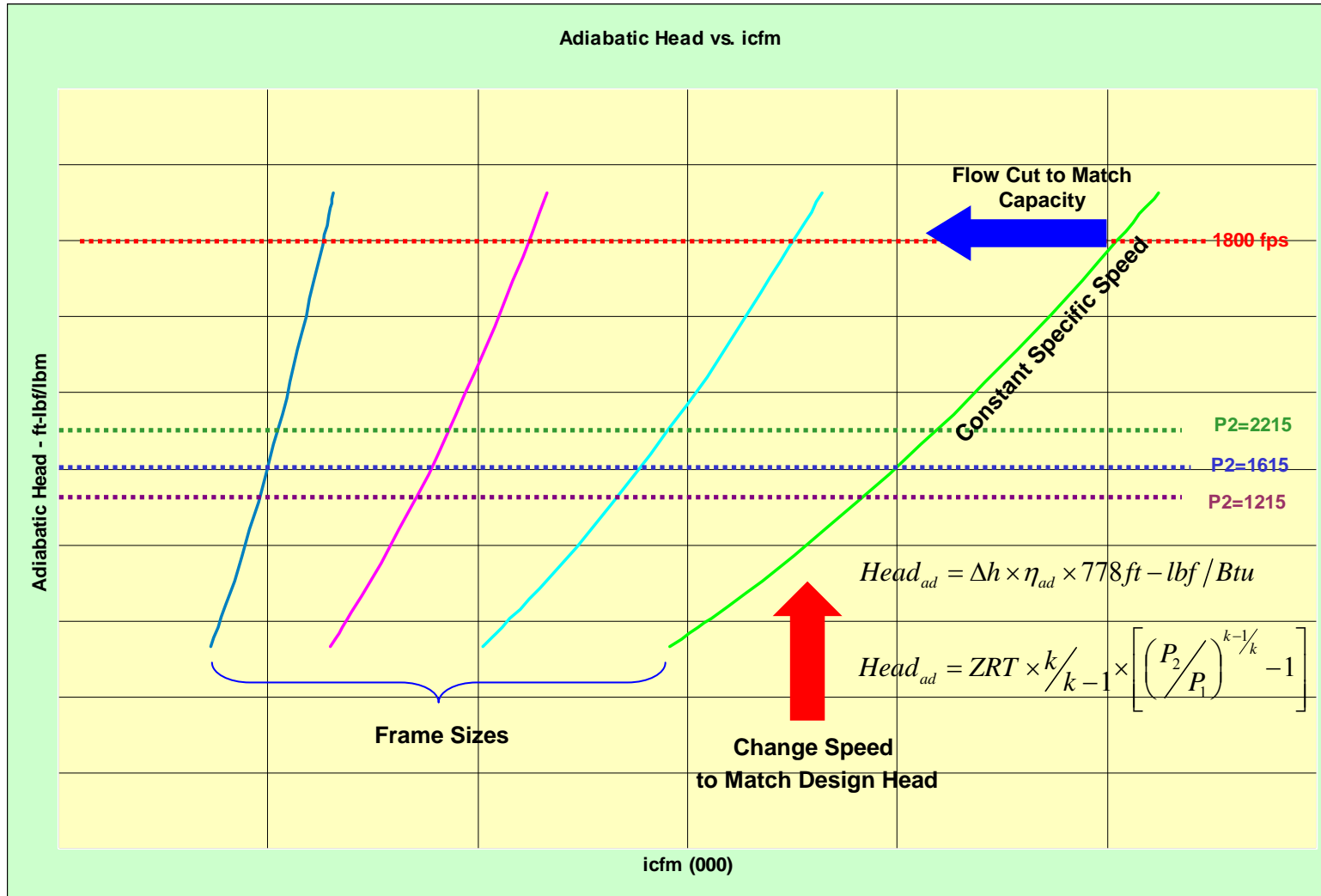



# “The Convenient Half-Truth”

	PC		SCPC		IGCC*		NGCC	
	w/out	with	w/out	with	w/out	with	w/out	with
Gross Power	583,315	679,923	580,260	663,445	770,350	744,960	570,200	520,090
Net Power	550,445	549,613	550,150	545,995	640,250	555,675	560,360	481,890
Coal Flowrate - lbm/hr	437,699	646,589	411,282	586,627	489,634	500,379	-	-
Natural Gas Flowrate - lbm/hr	-	-	-	-	-	-	165,182	165,182
Net Plant Heat Rate - Btu/kW-hr	9276	13724	8721	12534	8922	10505	6719	7813
Net Plant Efficiency - HHV%	36.8%	24.9%	39.1%	27.2%	38.2%	32.5%	50.8%	43.7%
Carbon Factor - lbm-CO <sub>2</sub> /mmBtu	203.3	203.3	203.3	203.3	196.7	196.7	118.5	118.5
Capacity Factor	85.0%	85.0%	85.0%	85.0%	80.0%	80.0%	85.0%	85.0%
Capture %	0.0%	90.0%	0.0%	90.0%	0.0%	90.0%	0.0%	90.0%
Capital Cost - \$/kW	\$1,549	\$2,895	\$1,575	\$2,870	\$1,813	\$2,390	\$554	\$1,172
LCOE - \$/kW-hr	\$ 0.0640	\$ 0.1188	\$ 0.0633	\$ 0.1148	\$ 0.0780	\$ 0.1029	\$ 0.0684	\$ 0.0974
CO <sub>2</sub> lbm/MW-hr Net Output	1886	278	1773	254	1755	206	797	93

Capture % to Achieve 797 or 278 lbm/MW-hr	57.7%	71.4%	55.0%	68.7%	54.6%	61.4%	0.0%	70.0%
	797	797	797	797	797	797	797	278

Note: Baseline Report Cases 1 & 2

$$\text{tons / year} = (\text{power}_{net} \times 8760 \times \text{capacity factor} \times \text{heat rate}_{net} \times \text{carbon factor}) / 10^6$$

$$\text{CO}_2 \text{ lbm} / \text{MWh}_{net} = \text{heat rate}_{net} \times \text{carbon factor} \times (1 - \text{capture}\%) / 10^3$$

NETL Cost & Performance Baseline  
NETL May 2007

# Technology Development Needs

---

## Compressor System

- **Compressor**
- **Drives**
  - High power 2-pole motor
  - High power VFD's
  - Steam turbine drives & control
- **Gearboxes**
  - Industry capacity
  - Auxiliary drive
- **Coolers - conventional service**
  - Air-cooled
  - Water-cooled
- **Heat Recovery Coolers**
  - Boiler feedwater
  - Solvent regeneration
  - Coal drying
  - Air pre-heater
  - Flue gas re-heating

## Capture System

- **Improved solvents**
  - Higher loading
  - Reduced regeneration heat
  - Improved thermal stability
  - Lower regeneration temperatures
  - Lower cost
  - Faster reaction kinetics
  - High pressure CO<sub>2</sub>

## Design & Analysis Tools

- NIST REFPROP CO<sub>2</sub> Mixtures with:
  - Water
  - CO
  - Argon
  - Oxygen
  - Ammonia
  - Hydrogen
- Heat exchangers for supercritical fluids
- Impurities & phase change models
- Generic capture system modeling capabilities – (Excel & ASPEN)
- Installed first cost & operating cost models
- Materials selection guidance

# Questions?

---



[pete\\_baldwin@ramgen.com](mailto:pete_baldwin@ramgen.com)  
**425-726-7272 (c)**

## Session 7.0

**Advanced Electric  
Drive Compressor  
Future R&D Needs**

## Session 7.1

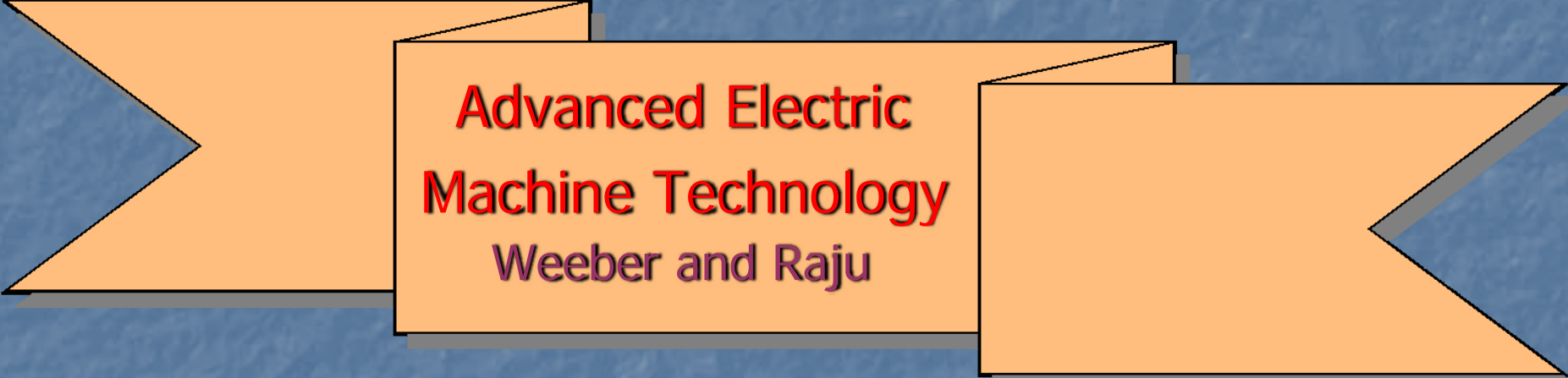

**Advanced Electric  
Machine Technology**  
Weeber and Raju

# Advanced Electric Machines Technology

Workshop on Future Large CO<sub>2</sub> Compression Systems  
sponsored by  
DOE Office of Clean Energy Systems, EPRI, and NIST

March 30-31, 2009

Konrad Weeber  
GE Global Research  
weeber@ge.com



imagination at work

# Mechanically Driven Compressors

## Mechanical Drive Benefits

- Historical solution with large installed reference base
- High ratings available
- Independent of electricity supply infrastructure

## Mechanical Drive Disadvantages

- Speed control & turn-down
- Low system efficiency
- Site emissions
- Site noise impact
- GT maintenance cycle

## Typical compression train configurations

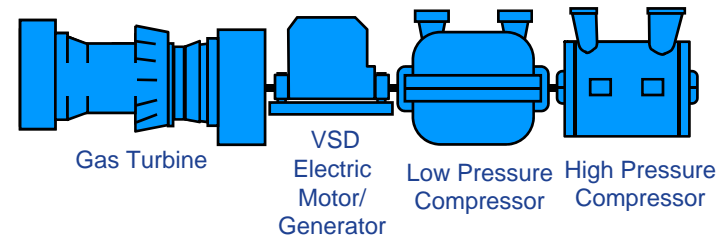
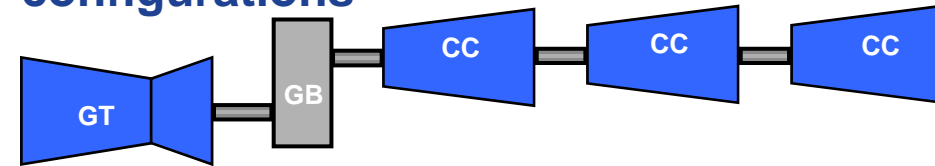

# Electrically Driven Compressors

## Electrical Drive Benefits

- Improved speed control
- Higher system efficiency
- No site emissions
- Reduced site noise impact
- Reduced maintenance, increased uptime
- Dynamic braking capability
- Short start-up time and load assumption
- Enable tight integration of drive motor with compressor

## Electrical Drive Challenges

- Requires availability of electricity on site
- Power ratings have to be met by both motor and frequency converter (“drive”)
- Required foot-print and weight associated with frequency converter

## Geared Electric Drives

- “low-speed” motor supplied by VFD
- Step-up gear-box

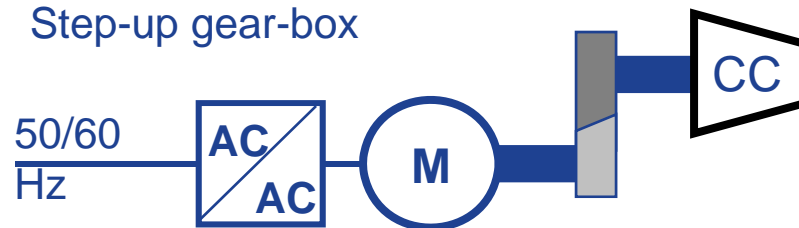

## High-Speed Electric Drives

- “high-speed” motor supplied by “high-frequency” VFD
- Gear box eliminated
- Motor either stand-alone or integrated with compressor





# High-Speed Multi-MW Drive Motors

## Wound-field synchronous machines

- Highest speed typically ~7500 rpm
- Higher speeds limited by mechanical support of field winding
- 50-80 MW below 4000 rpm

## Induction machines

- Widest application of “high-speed” multi-MW machines
- Laminated & solid rotor design

## Permanent magnet machines

- New emerging technology
- Improved efficiency
- Robust rotor technology
- Preferred choice above ~ 15,000 rpm

### High Speed Machines

Examples of machines from several different manufacturers

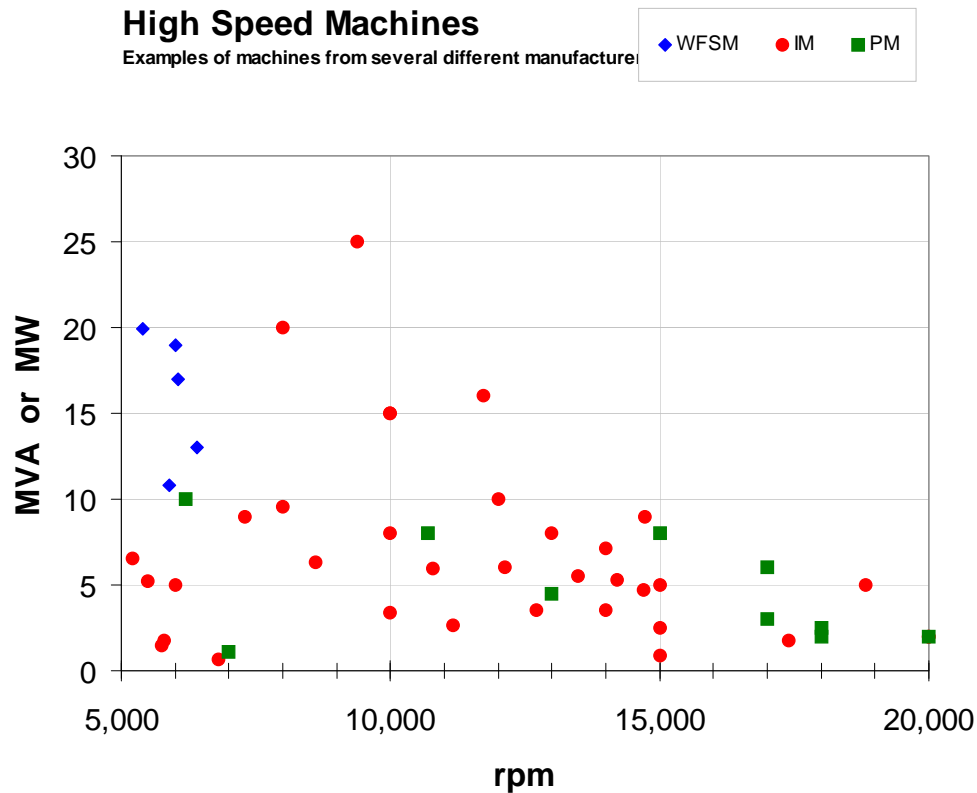

# Integrated Motor-Compressor

## Integration Characteristics

- Direct coupling of motor & compressor rotors
  - **No gear box**
- Motor shares casing with compressor
- No rotating shaft component penetrates pressure vessel
  - **No shaft-end seals**
- Power train levitated by magnetic bearings
  - **Oil-free system**
- Motor cooled with process gas
  - **No External cooling system**

## CAPEX Benefits

- No gear
- Simplified auxiliaries (no lube oil & oil cooling)
- Smaller footprint & weight

## OPEX Benefits

- Reduced down-time for maintenance
- Unmanned operation & remote control
- No site emissions
- Reduced noise

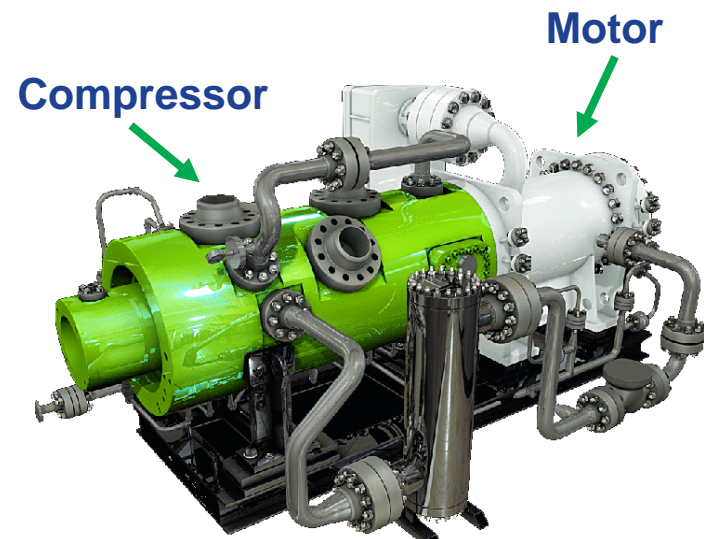

**6 MW 12,000 rpm prototype  
With laminated-rotor  
induction machine**

## Challenges

- Process gas compatibility of motor
- Especially for sour gas, acid gas, wet gas  
.....

# Hermetically Sealed Compression

## Clean gas applications

- Motor cooled w process gas
- Stator and AMBs are not encapsulated
- **Substantial simplification of compression station compared to geared electric drive**

## Sour gas applications

- Motor cooled w process gas
- Stator and AMBs are encapsulated
- All materials exposed to process gas are NACE compliant
- **Hermetically sealed for subsea compression & acid gas injection**

Plot Plan of a Conventional Land Based Compression Station, 3x 10MW Trains

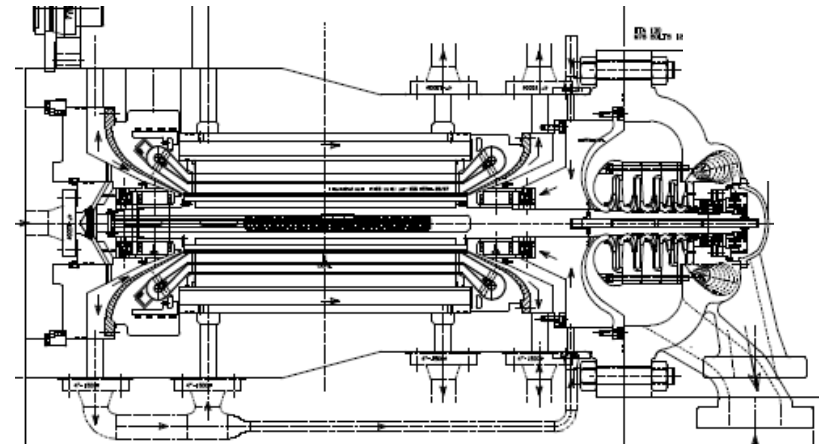
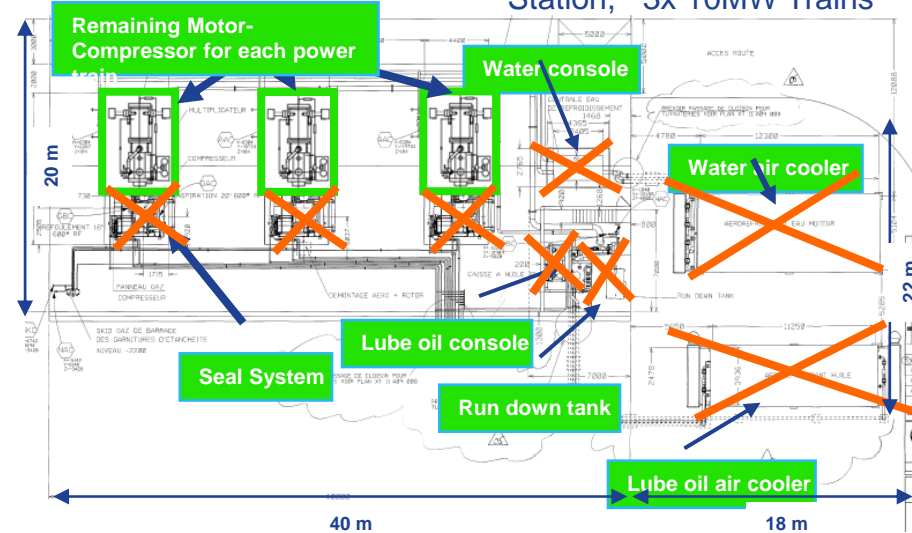

# Permanent Magnet Rotor Technology

## Configuration

- Rare-earth permanent magnet rotor poles
- Metallic retaining ring
- Rigid rotor design
- Multi-plane rotor balance
- Magnetization after assembly

## Technology Benefits

- Robust manufacturing process
- No active rotor components
- Minimal heating and thermal cycling
- Best efficiency
- Materials in contact with process gas are NACE compliant

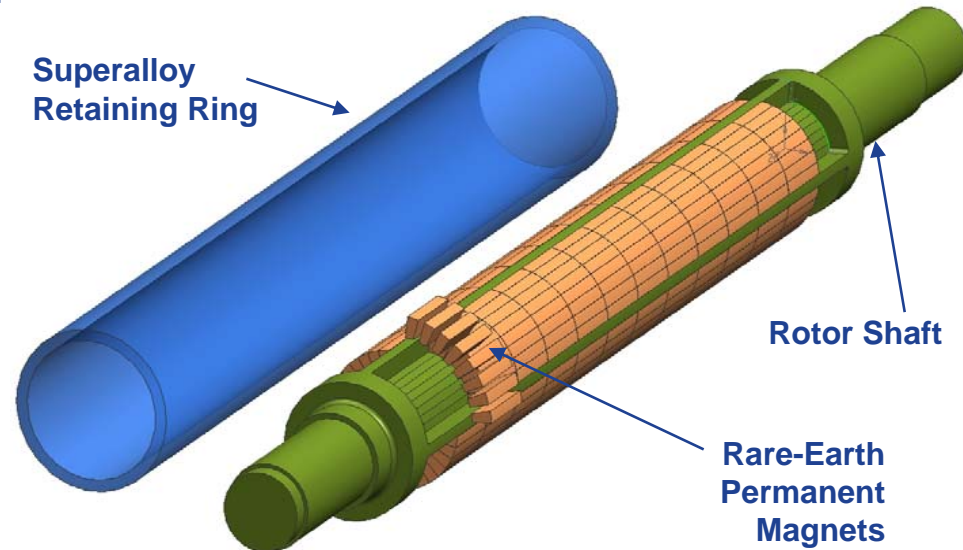

**Most Robust Architecture for High-Speed**

# Motor Technology Development

- Manufacturing process
- Rotor mechanical design
- Rotor-dynamic design
- Bearing technology
- Magnetization process
- High-frequency stator design
- Stator encapsulation

Sub Scale Rotors:  
1 MW 17,000 rpm



Reduced (1/6) Length  
Same Cross Section

Full Scale Prototype Rotor  
6 MW 17,000 rpm



# Demonstration Spin Rotor

## Set up

- Rotor with full-size cross section
- Exposed magnet-to-shaft plane for instrumentation
- Pendulum-style spin pit

## Proof test @ 125% speed (21,250 rpm)

- Performed at 3 different temperatures
- No observed dynamic instability
- No dimensional changes
- No signs of damage
  - ✓ **Structural integrity**
  - ✓ **Thermal stability**
  - ✓ **Balance Stability**

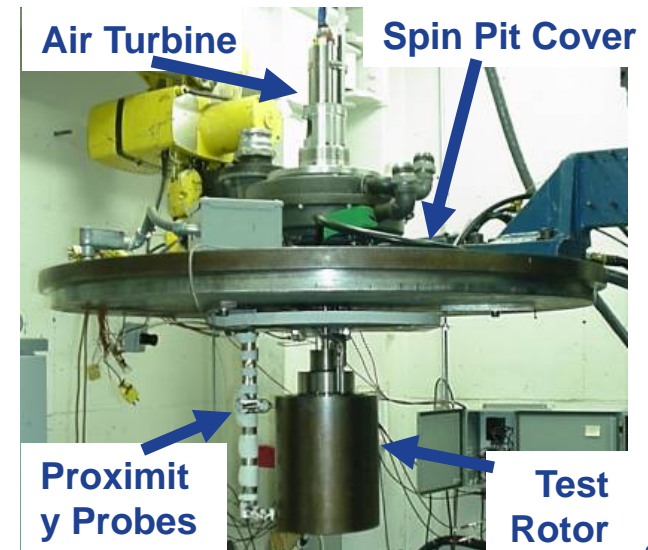
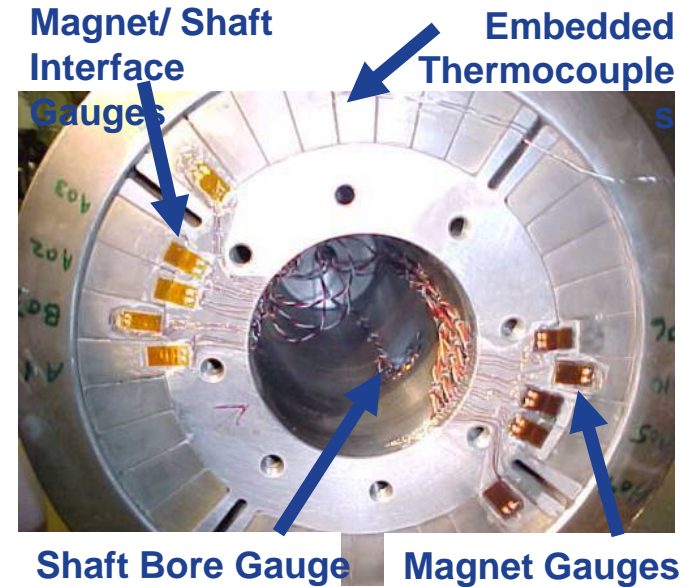

# Magnetization Process

## Novel Aspects of this PM rotor

- Single-shot magnetization
- Magnetization through retaining ring

## Results

- ✓ Accomplished target magnetization level
  - ✓ Uniform magnetization levels pole-pole
  - ✓ Magnetization through retaining ring
  - ✓ Mechanical integrity
- **Largest PM rotor built to date for single-shot magnetization**

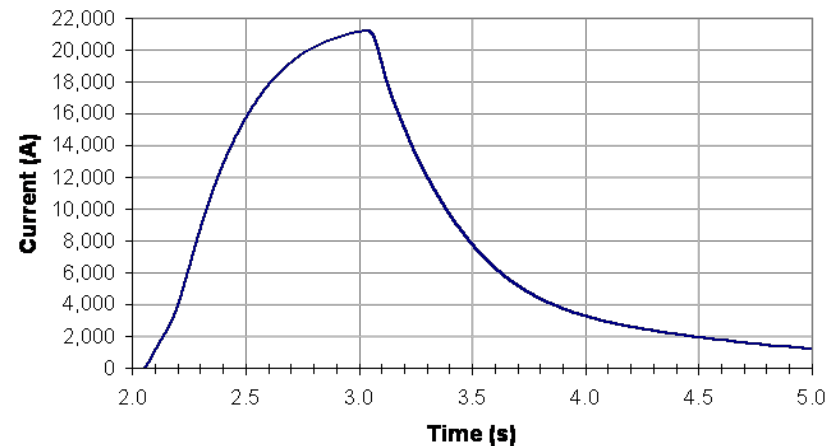
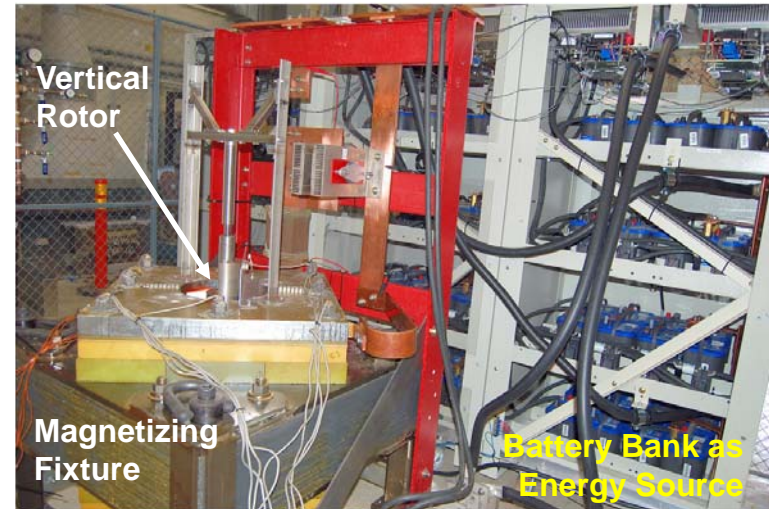

# Rotor-Dynamic Spin Tests

## Set up

- Full-size prototype rotor (6 MW @ 17,000 rpm)
- Active magnetic bearings
- Geared drive motor
- “No-load” mechanical spin tests

## Primary Objectives

- Confirm mfg process for full-size rotor
- Validate rotor-dynamic response of rotor
- Validate rotor support by magnetic bearings
- Perform magnetic bearing drop tests

**AMB stator**



**AMB journals**



# Rotor-Dynamic Spin Tests

**6 MW 17,000 rpm  
Demonstration Rotor**

## Set up

- Full-size prototype rotor
- Active magnetic bearings
- Geared drive motor
- “No-load” spin tests

***World record - highest-rated PM @ rated***

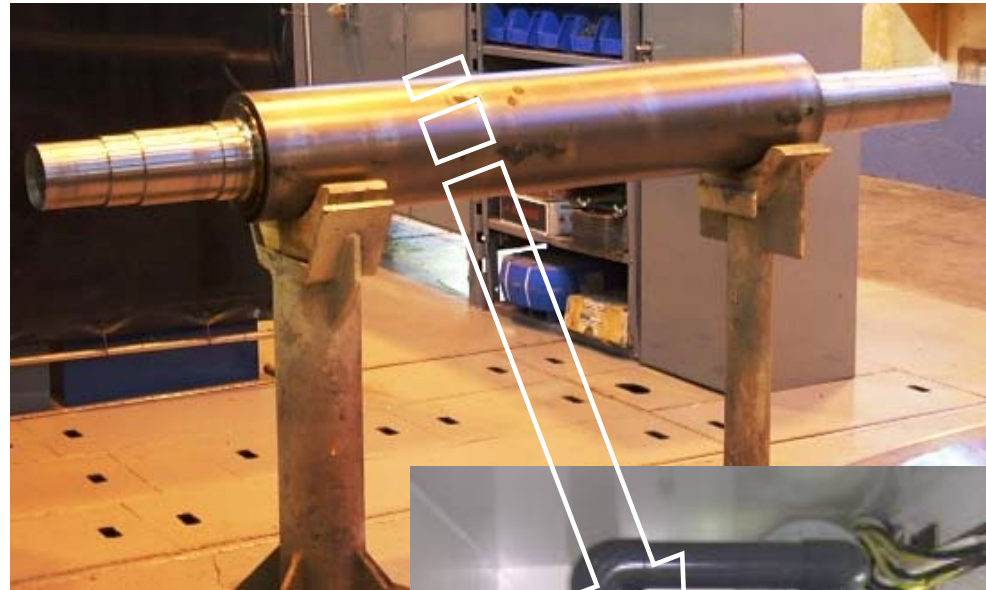

# Hermetically Sealed Stator

## Electrical Insulation System

- Electrical operating parameters:
  - Rated line-line voltage: 4.16 – 6.6 kV
  - Fundamental frequency: 333 – 666 Hz
- Class F system operated @ class B rise
- Standard inverter-duty VPI system

## Hermetic Encapsulation

- Fully encapsulated stator winding
- NACE compliant materials at gas interface
- Conduction-cooled by process gas

**5 MW Prototype**

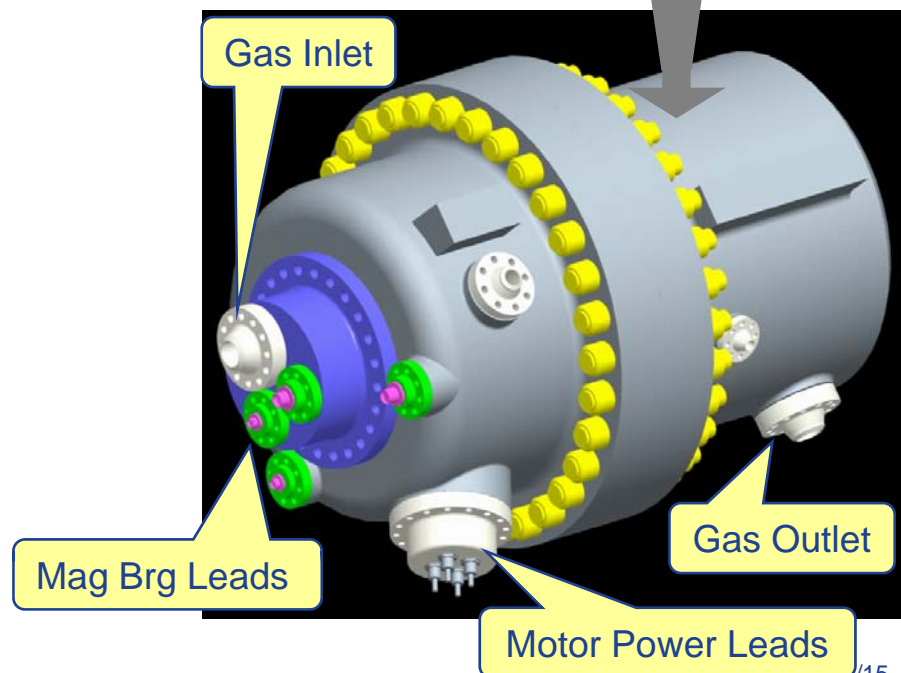

# High Speed Electric Compression

## Clean gas



### **APPLICATIONS**

Gas storage and small pipeline & clean gas applications for upstream

### **GE SOLUTION**

- Integrated & stand alone HSEMC
- Motor cooled by process gas
- Oil-free solution

### **ADVANTAGES**

- oil-free, seal-less design
- unmanned solution
- Compactness.. less infrastructure
- Lower CAPEX & OPEX ... low maintenance

## Subsea compression

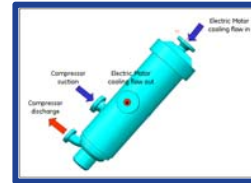

### **APPLICATIONS**

Subsea / wet gas compression

### **GE SOLUTION**

- “Marinized” integrated HSEMC
- motor cooled by process gas
- raw / wet gas design
- Vertical & horizontal design

### **ADVANTAGES**

- oil-free, seal-less design
- Reliability ... robustness
- Zero maintenance
- Small footprint / weights... easy handling

## Raw gas / sour gas



### **APPLICATIONS**

Acid / sour gas injection, aging wells boosting etc.

### **GE SOLUTION**

- Integrated HSEMC with gas cooled Motor (“raw gas” design)
- HS stand alone motor

### **ADVANTAGES**

- Oil-free, seal-less design
- More compact... reduced footprint
- Low maintenance ... Increased safety

# R & D Needs

- Advanced Stator and Rotor cooling schemes
- Improved materials for high speed rotors, advanced design tools
- Advanced Stator and Rotor materials to handle corrosive gases
- Improved drive electronics
  - higher fundamental frequencies for high speed machines
  - improved controls and bandwidth to provide low torque ripple
- Tighter integration of compressor, motor and drive components and engineering.

# Thank you

## Q & A

## Session 7.2

**Advanced Electronic  
Components for High Speed,  
High-megawatt Driver  
Stevanovic**

# Advanced Components for High Speed, High-MW Drives

Presented at NIST/DOE Workshop on CO<sub>2</sub> Compression

March 30-31<sup>st</sup>, 2009

Ljubisa Stevanovic, Chief Engineer, Advanced Technology Office

GE Global Research Center

(518) 387-5983

stevanov@crd.ge.com

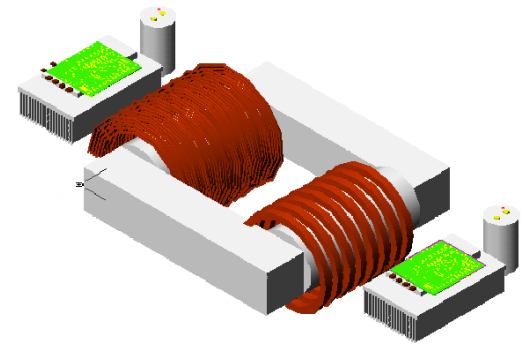
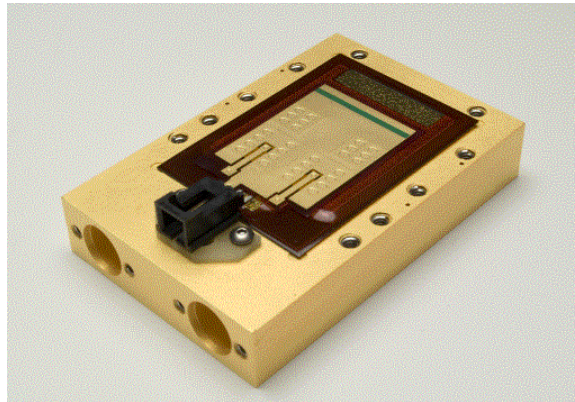
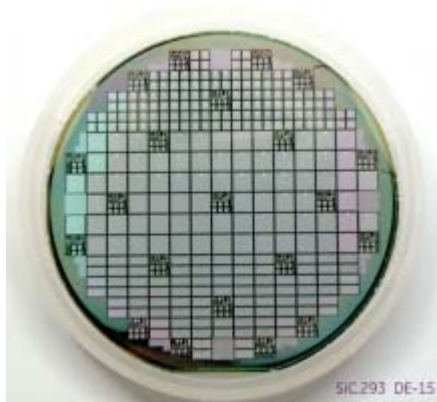

# Presentation Outline

- SiC Power Devices
- SiC Power Packaging
- Magnetics
- Conclusions



# Presentation Outline

- SiC Power Devices
- SiC Power Packaging
- Magnetics
- Conclusions

# Semiconductor Power Devices

- SiC: fast high voltage devices that can operate at temperatures well above 200°C

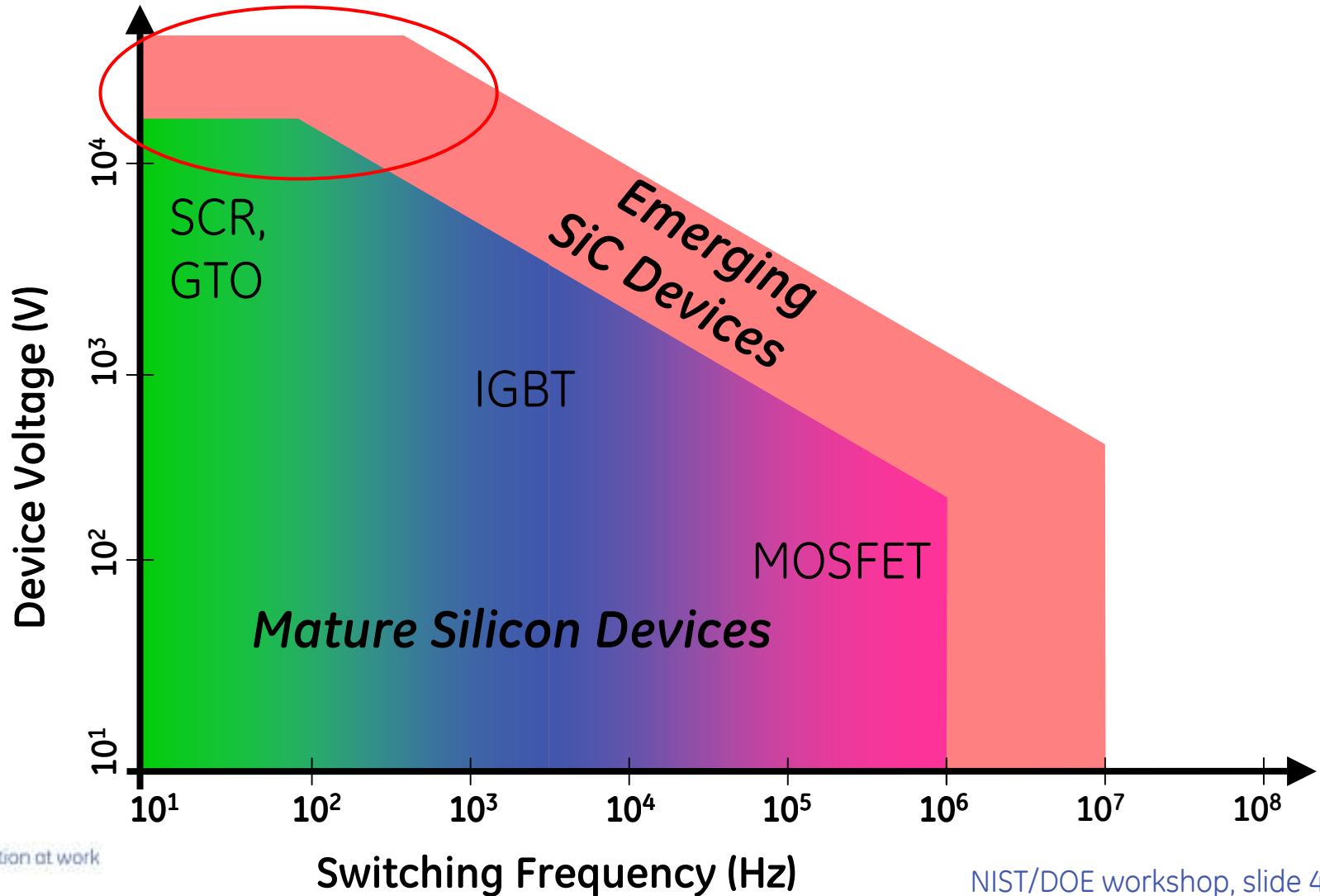
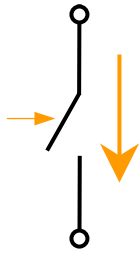



# DARPA HPE Phase II Program



## Objective:

DARPA/ONR Contract#: N00014-07-C-0415

*A 2.7 MVA, 13.8 kVac/ 465 Vac, solid-state transformer switching at 20 kHz*

## Features:

- 10 kV SiC power devices
- High voltage, 20 kHz magnetics
- Modular power converter architecture

## Benefits:

- Forty transformers on CVN-78 aircraft carrier; total estimated benefit: 172 tons, 292 m<sup>3</sup>
- Fault-current limiting, improved power quality
- Flexibility, ability to supply both AC & DC loads



## Partners:

- Cree, Inc.
- Powerex, Inc.
- General Dynamics Corp.
- Los Alamos National Lab.
- Virginia Tech, University of Wisconsin-Madison

# DARPA HPE Phase II Program

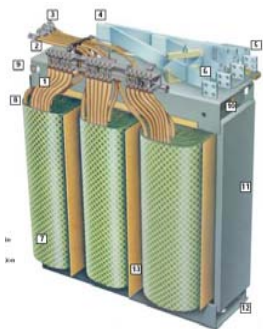

## Low Frequency Conventional Transformer (analog)

- 2.7MVA
- 13.8kV/450V ( $\Delta/Y$ ) 60Hz
- **6 tons/each**
- **10 m<sup>3</sup>/each**
- **fixed, single output**

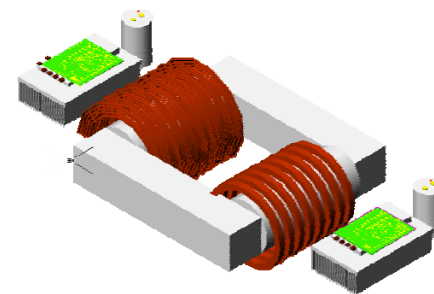

## Estimated SiC-based Solid State Power Substation (digital)

- 2.7 MVA
- 13.8kV/465V ( $\Delta/Y$ ) 20 kHz
- **1.7 tons/each**
- **2.7 m<sup>3</sup>/each**
- **multiple taps/outputs**

## **BENEFITS:**

- Reduction of weight and volume
- Precise voltage regulation to isolate voltage spikes, voltage dips
- Unity Power Factor (20% increase in power)
- Fast fault detection, protection, and potential removal of circuit breakers



# System Integration for Representative SSPS Topology

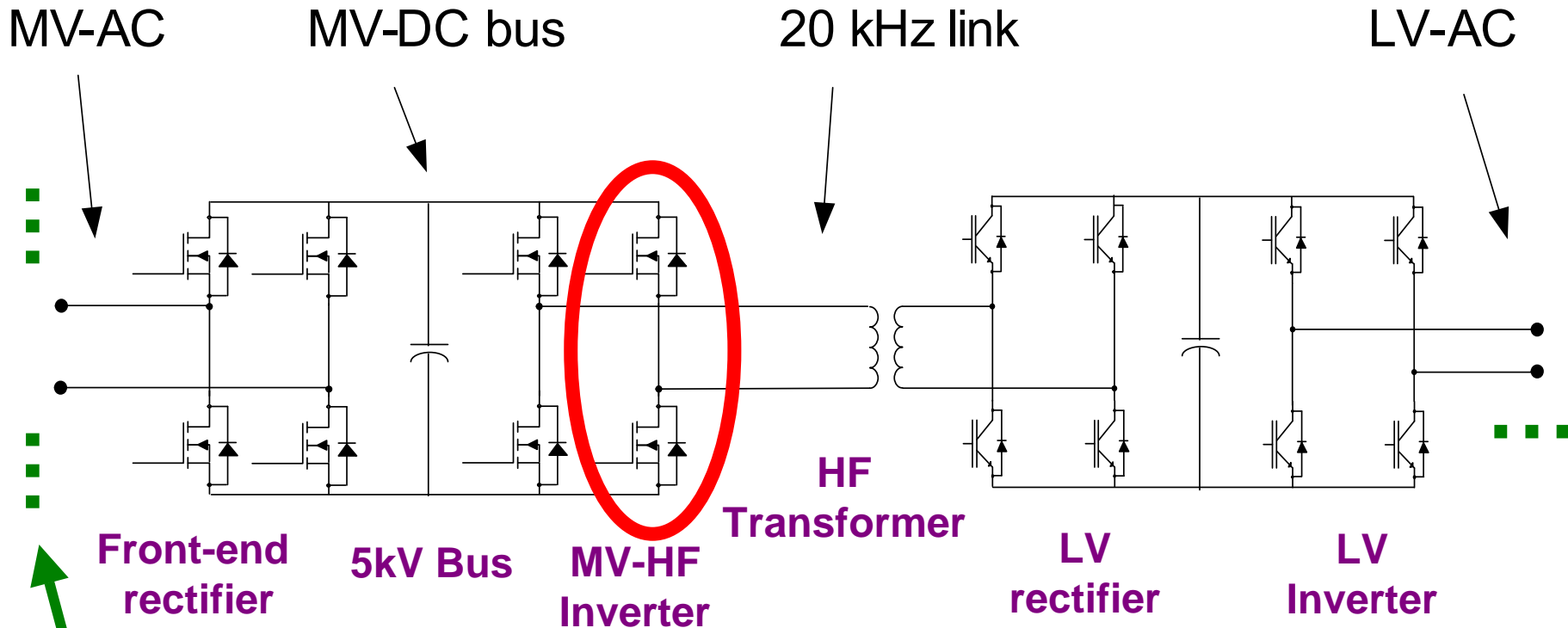

This configuration requires **four series blocks** for each phase of the 2.75 MVA, 13.8 kV to 465 V SSPS.

# DARPA HPE MOSFET: High Speed at High Voltage

SiC MOSFET: 10 kV, 30 ns

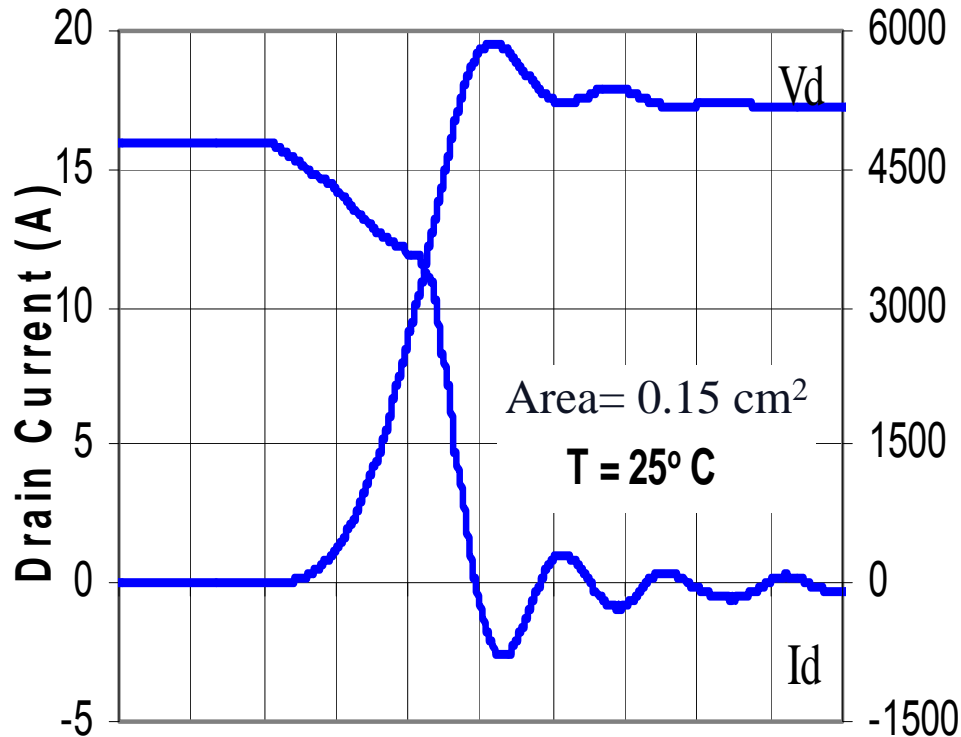

15 ns /div

Silicon IGBT: 4.5 kV, 2us

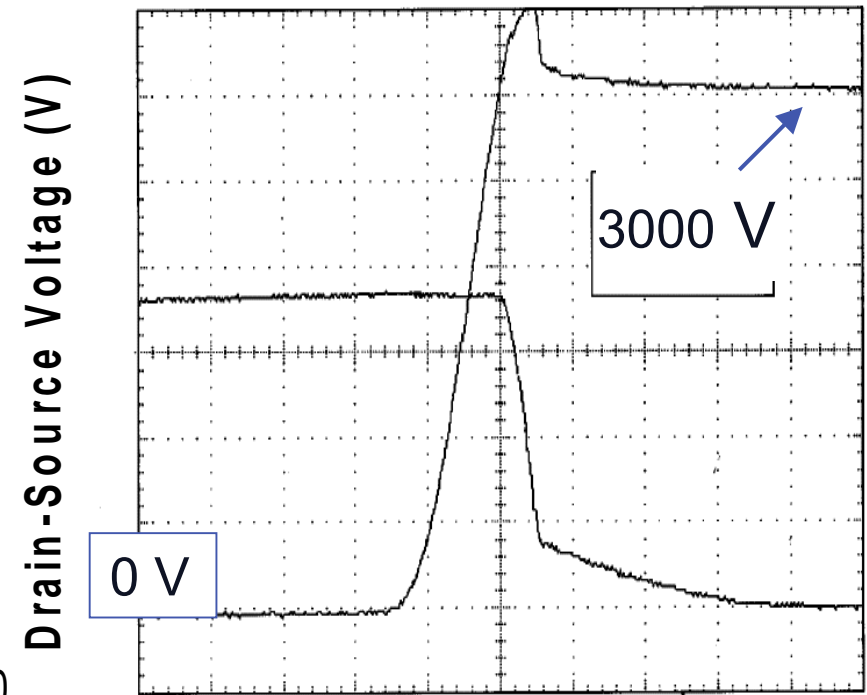

1us /div

# SiC Device Requirements/Challenges

No commercially available 10 kV SiC devices

Requirements/challenges:

- Lowest losses at  $>10\text{kV}$ ,  $\sim 1\text{kHz}$

$V_{\text{ON}}(T)$  for majority carrier devices

- High current chips/modules

Yield of large MOS-gated (MOSFET, IGBT) devices

- High reliability and stability over temperature, time

Gate oxide reliability, stability

Bipolar degradation

***Need robust and reliable devices scaleable to  $>1\text{ kA}$***

# Presentation Outline

- SiC Power Devices
- SiC Power Packaging
- Magnetics
- Conclusions



# Power Module Challenges

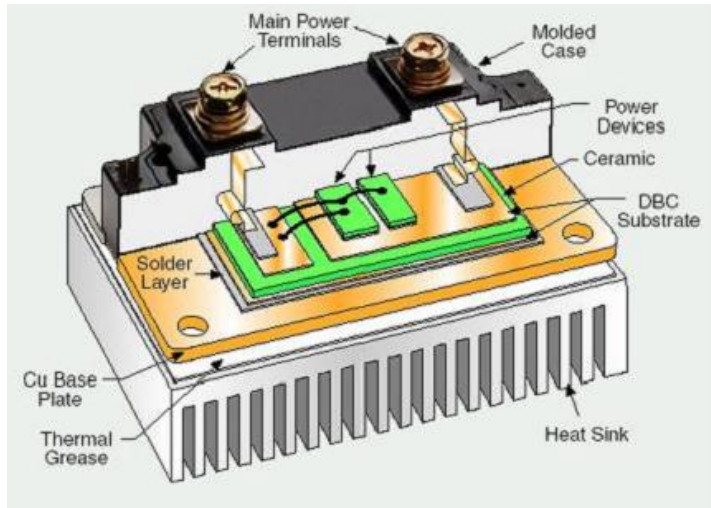

- Thermal limitations
- Electrical de-rating
- Wirebond reliability

## Power Loss Density

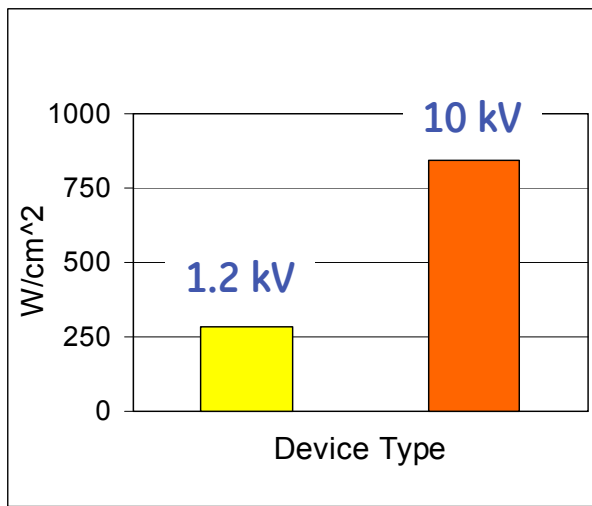

## Parasitic Inductance

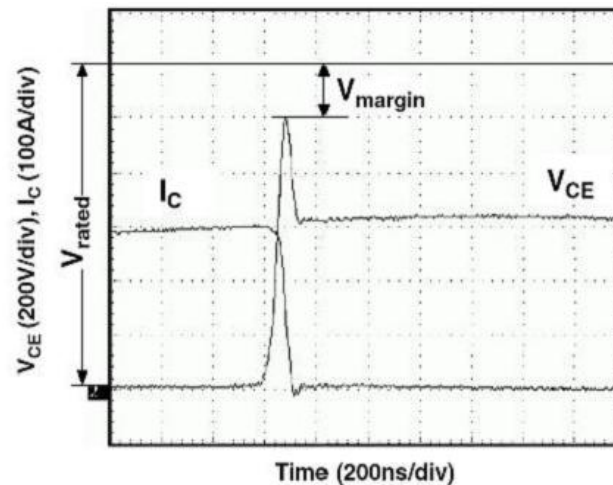

## Wirebond Reliability

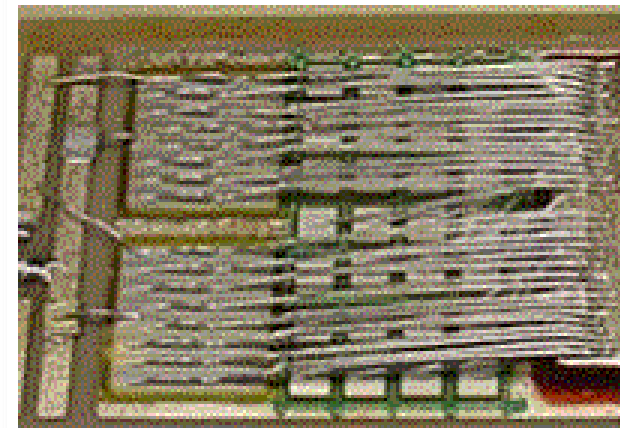

# Module Thermal Study

## Test heatsinks:

4x150A IGBTs

Same layout, same DCB (AlN)

Three heatsinks: 3-D flow, Micro-/Mini-channels

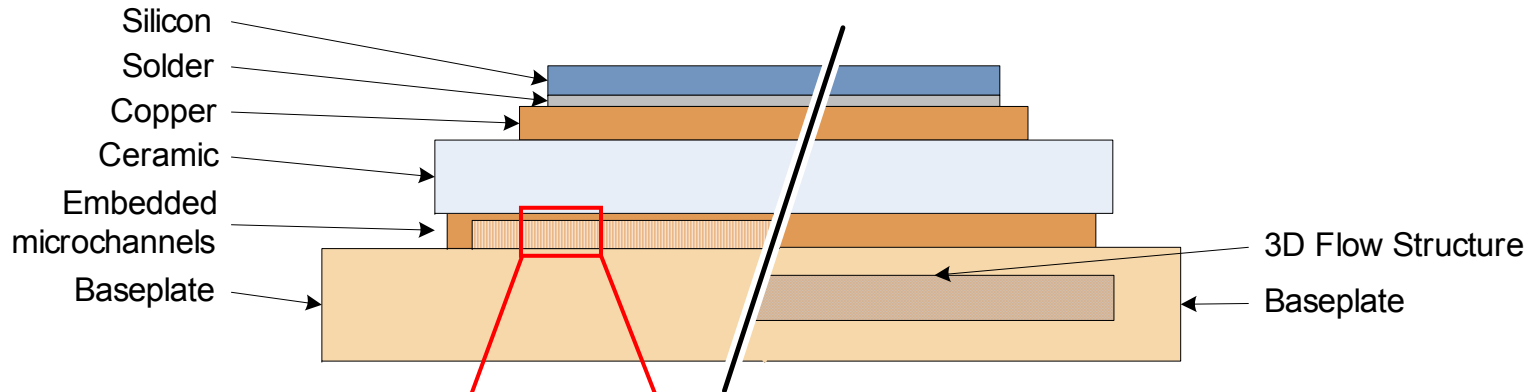
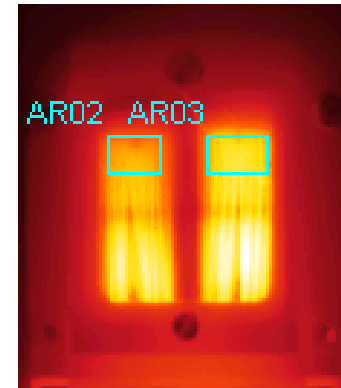
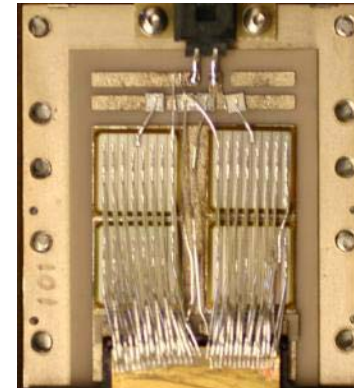

## Micro/Mini channels:

- Integrated in DCB
- Smallest features:  
0.1mm/1mm



## 3-D flow:

- Embedded in baseplate
- Features as small as 0.3mm

# Module Thermal Study

## Micro-channel offers best performance:

- High ratio of surface area to fluid volume
- Short channel length  $\rightarrow$  lower  $\Delta P$

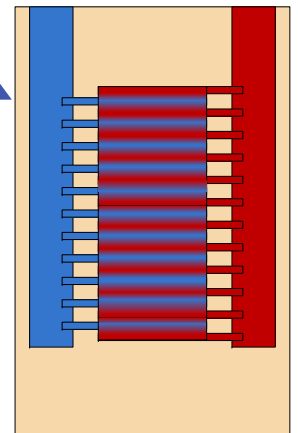
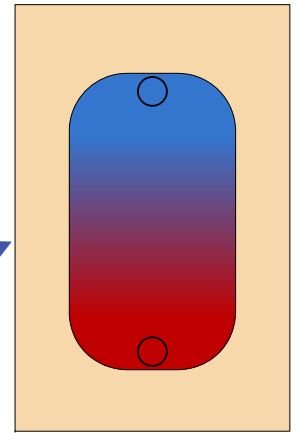
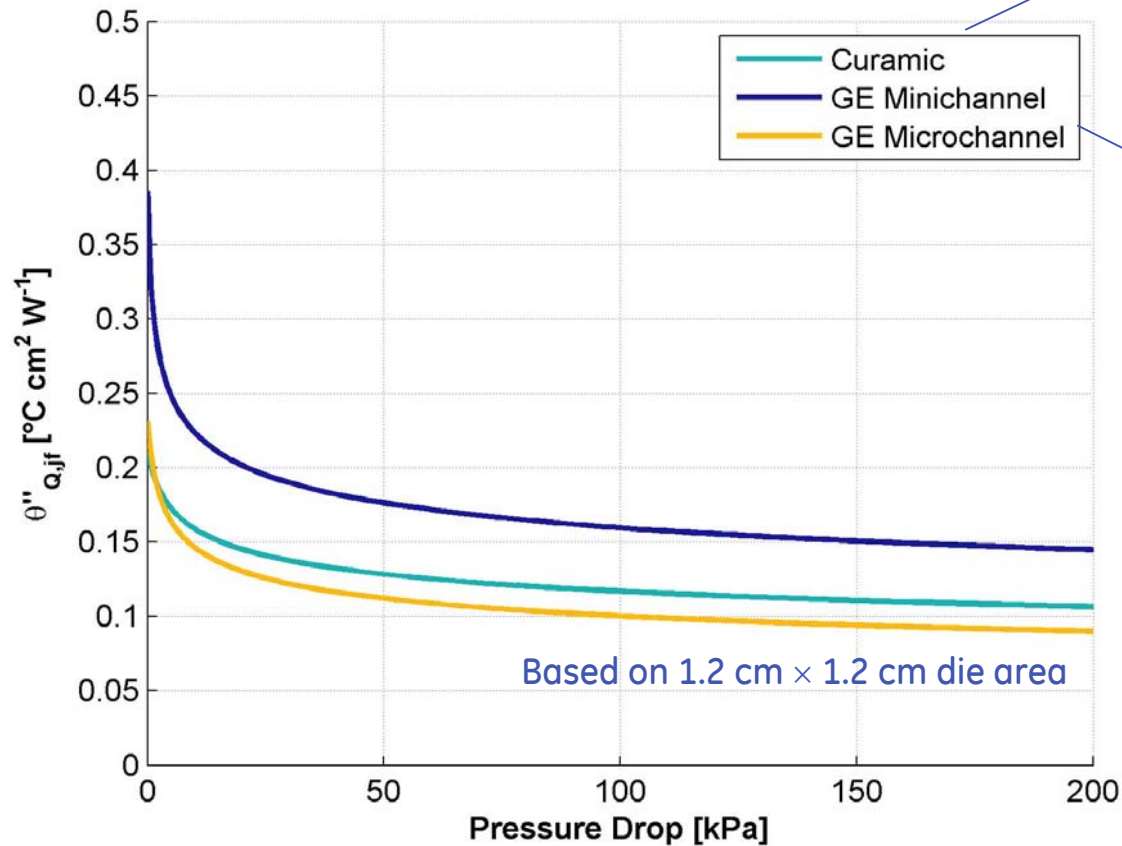

# Power Module Roadmap

## Conventional Wirebonded

## Advanced Wirebondless

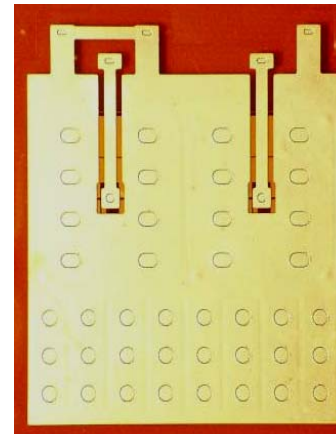
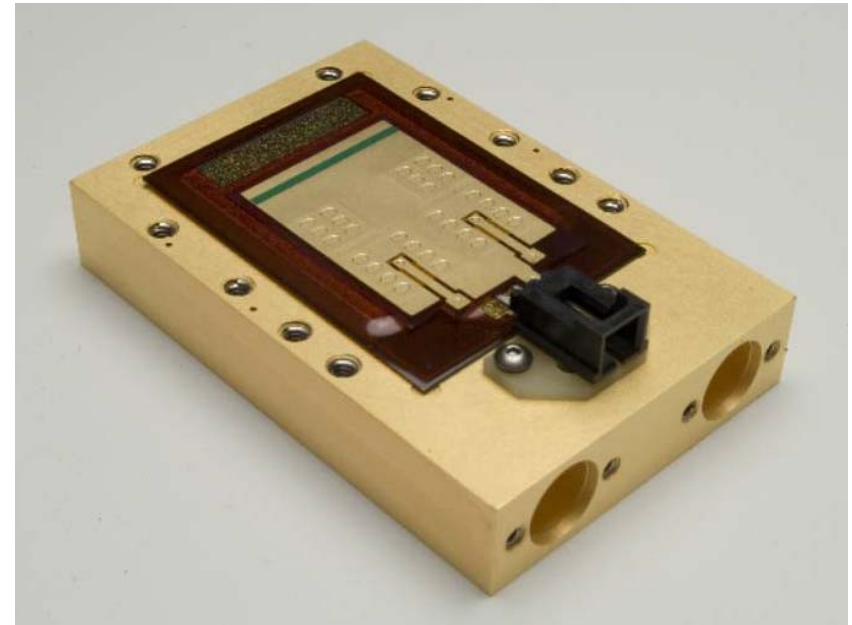
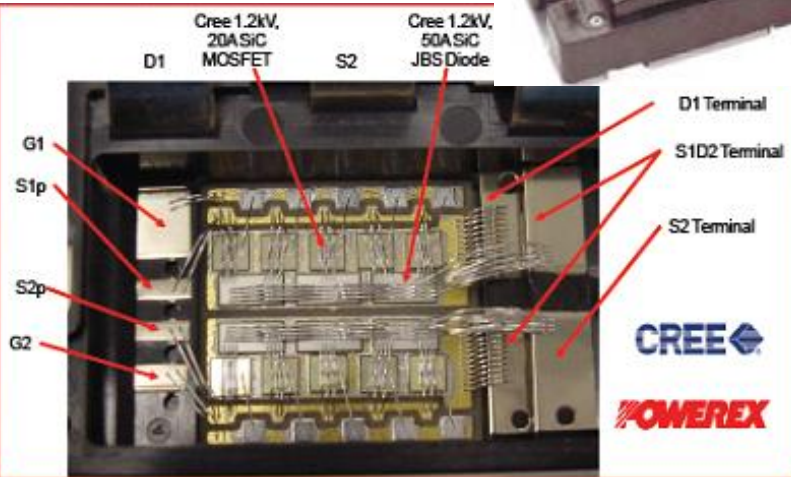

# Advantages of Wirebondless Module

- Higher power density
- Reduced package thickness and area
- Interconnect many devices using artwork
- Different via sizes as needed without change in process
- Less parasitic L (better current sharing, switching loss)
- Lower contact resistance (lower conduction loss)
- Planar interconnect enables top-side cooling
- Higher surge current capability

## GE Power Overlay - POL

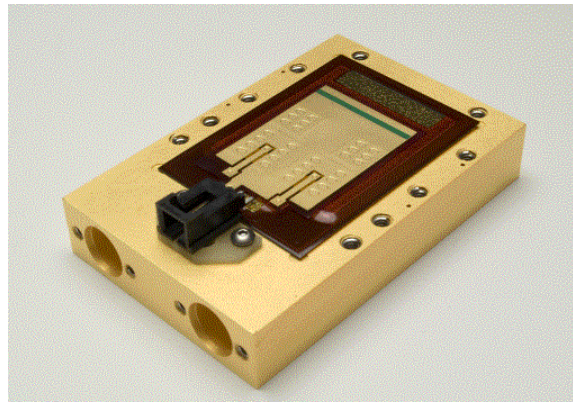

# Double-sided Cooling

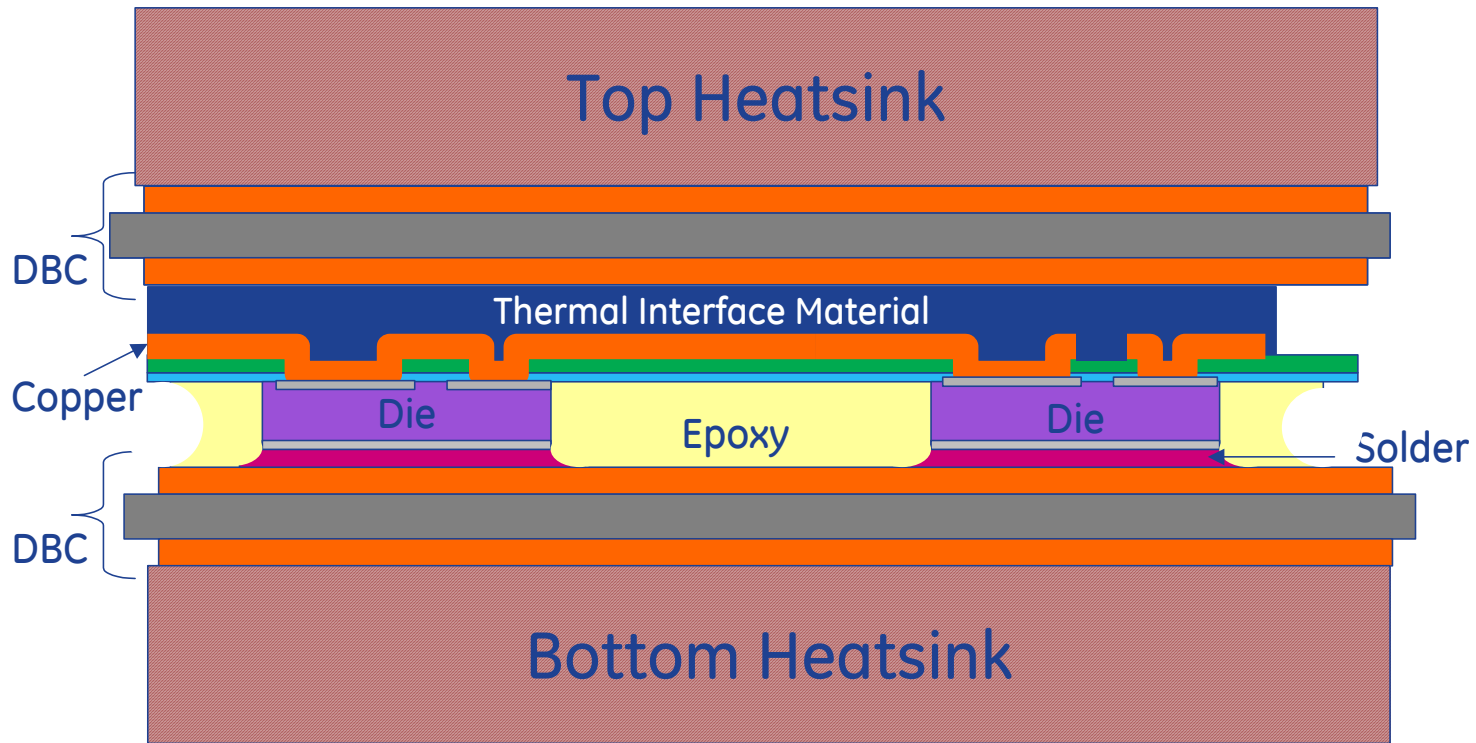

Not to Scale

Improvement from  
top-side heatsink:

15-30% with water-  
based microchannel,  
up to 40% with P.G.

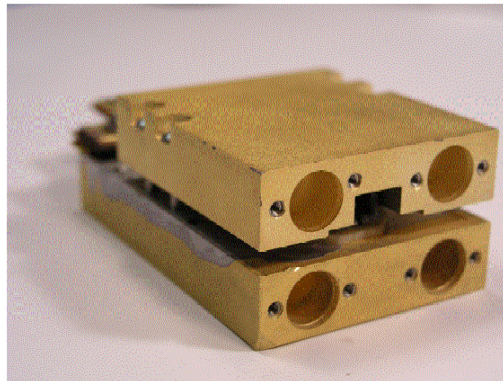

# Power Module Requirements/Challenges

No commercially available  $>10$  kV,  $>1$  kA modules

Requirements/challenges:

- High reliability

Device interconnect for high currents & temp's

Materials CTE matching

- Topology requirements for module failure modes

Fault tolerant to open/short failure

- Thermal performance

High performance (top & bottom) device cooling

***Need advanced packaging to maximize benefits of SiC***

# Presentation Outline

- SiC Power Devices
- SiC Power Packaging
- Magnetics
- Conclusions



# New Soft Magnetic Materials

## Minimize hysteretic losses

- New alloy compositions (amorphous & crystalline)
- Novel nanostructures to reduce coercivity

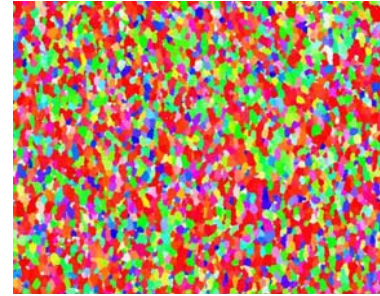

## Minimize eddy current losses

- New material geometries enabled by advanced material processing techniques
- Enable wide range of operating frequencies

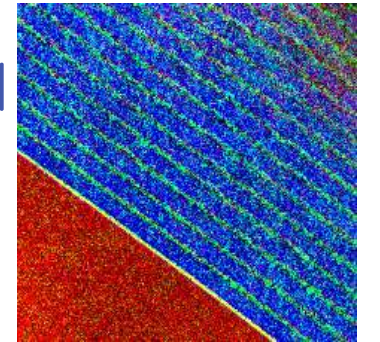

## Maximize materials utilization

- Maintain balance of properties
  - High saturation magnetization (1.5 – 2.0 T)
  - Operating temperature (> 300 °C)

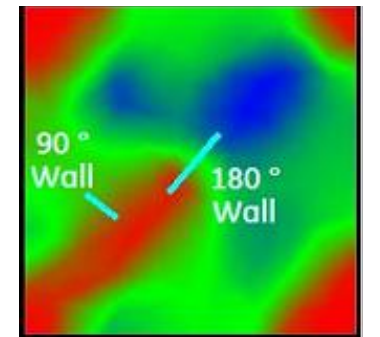

# New Magnetic Materials R&D/Investment Needs

## Alloy design

- Advance alloy theory and modeling to impact:
  - Saturation magnetization -> Increase power density
  - Anisotropy -> reduce power loss
  - Magnetostriction -> reduce power loss
- **Good opportunity for University partnerships**

## Material Characterization

- Apply advanced magnetic and structural probes to magnetic materials
- **Leverage metrology facilities at NIST and National Labs**

## Material processing

- Develop new process routes to achieve desired microstructures
- Validate material performance in pilot-scale processing
- **Utilize National Lab facilities (e.g. Oak Ridge, Ames)**
- **Good opportunity for public/private collaboration to mitigate risk**

# Summary

No commercially available SiC devices for  $>10$  kV,

Need robust and reliable devices scaleable to  $>1$  kA

No commercially available  $>10$  kV,  $>1$  kA modules

Advanced packaging to maximize benefits of SiC

Need high efficiency,  $B_{SAT}$ , temp magnetic materials

# Questions?

## Session 7.3

**Future High-Voltage SiC  
Power Device Manufacturing  
Technology  
Palmour**



# **Future High Voltage Silicon Carbide Power Devices**

**Workshop on Future Large CO<sub>2</sub> Compression Systems**

**March 31, 2009**

**John W. Palmour**

**Cree, Inc.**

**4600 Silicon Drive  
Durham, NC 27703; USA**

**Tel:: 919-313-5646**

**Email: [john\\_palmour@cree.com](mailto:john_palmour@cree.com)**



“All I’m saying is now is the time to develop technology to deflect the asteroid.”

# Benefits of SiC Power Technology

## 10X Breakdown Field of Si

- Tradeoff higher breakdown voltage
- Lower specific on-resistance
- Faster switching

## 3X Thermal Conductivity of Si

- Higher current densities

## 3X Bandgap of Si

- Low  $n_i \Rightarrow$  Low leakage current
- Higher temperature operation

- Higher Breakdown Field and Current Densities in SiC Devices
- Replace Si Bipolar With SiC Unipolar Devices

> 2x Reduction in Total Losses

Plus Operation at 200°C SiC Junction Temperature

- 85% Reduction in Cooling
- 3-5% Higher Efficiency

Plus Higher SiC Device Switching Frequency

Dramatic Reduction in Size & Weight of Power Modules & Converters



# SiC MOSFETs and Schottky Diodes show Zero $Q_{rr}$

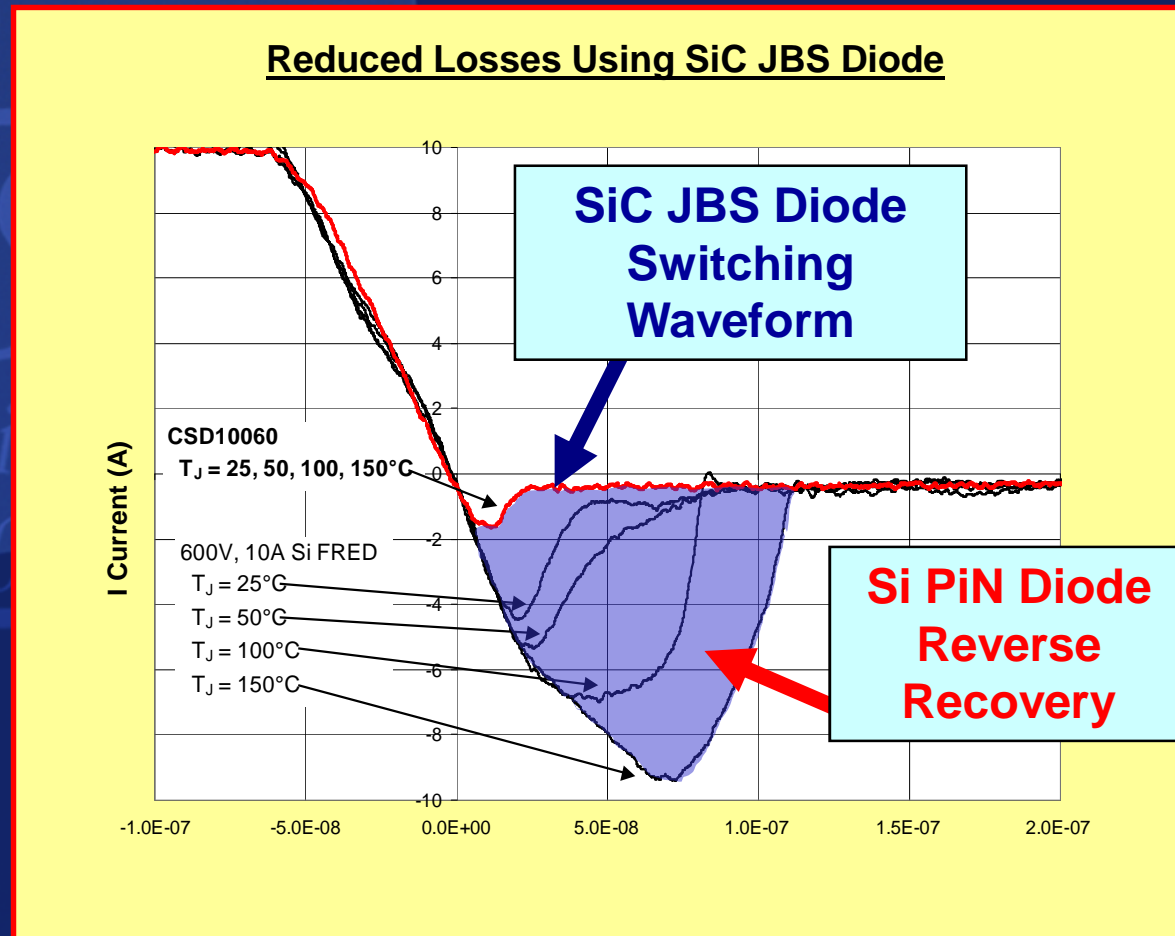

# Commercially Available SiC JBS Rectifiers

- Cree *ZERO RECOVERY™* Rectifier Product Family
  - 600V 2A, 4A, 6A, 8A, 10A & 20A
  - 1200V 5A, 10A, 20A, 50A
- Major Applications
  - Power Factor Correction (PFC) in Switch Mode Power Supplies (SMPS)
  - Anti-Parallel rectifier in Motor Control
  - Boost Converter and Inverter Section for solar conversion



# Extremely Low Field Failure Rate Of Cree SiC JBS Diodes

## Cree Field Failure Rate Data since Jan. 2004

Product	Device Hours	FIT (fails/billion hrs)
CSDxxx60	75,200,000,000	0.6
CSDxxx60	42,700,000,000	0.1
CSDxxx60	7,060,000,000	0.1
CSDxxx60	2,440,000,000	0.4
<b>Total</b>	<b>127,400,000,000</b>	<b>0.4</b>

- 1200 V Schottkys have **zero field failures** since introduced in Sept. 2006
- 2 largest Cree Customers: **“Your SiC parts are much more reliable than the Silicon parts we were using.”**

# 4H-SiC 1200V 20A DMOSFET Chip Layout

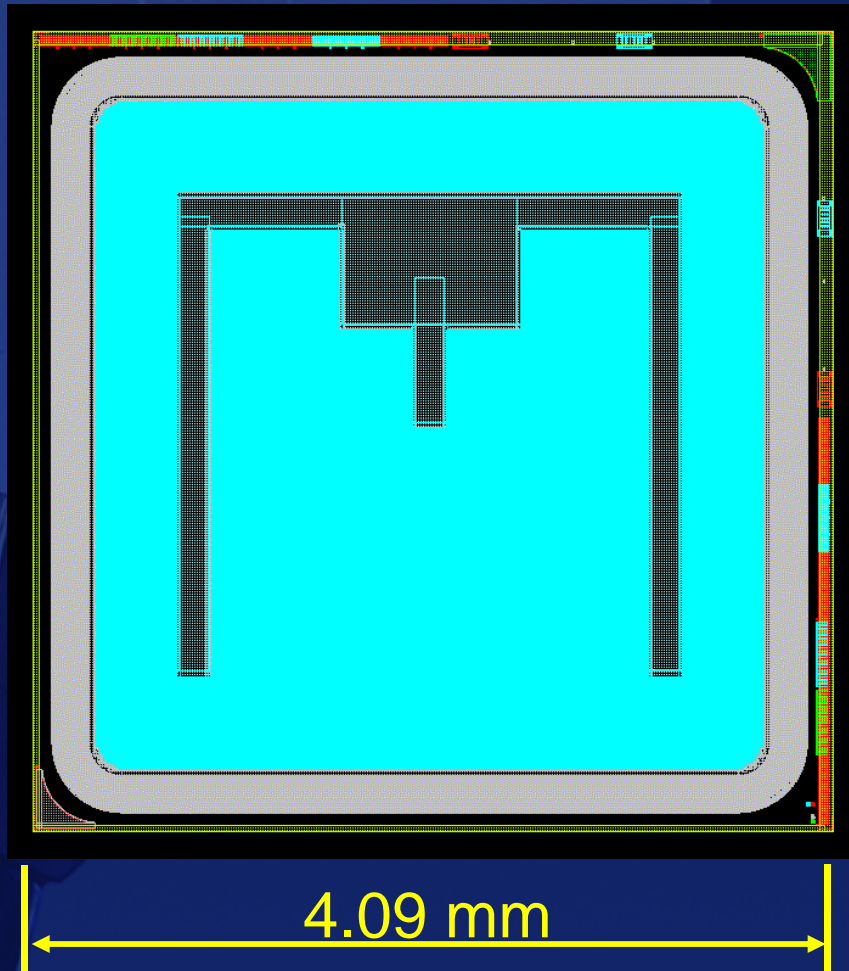

>50,000 cells per chip

4.09 mm x 4.09 mm chip size  
0.101 cm<sup>2</sup> active device area

$$R_{\text{on,sp}} \approx 10 \text{ m}\Omega \cdot \text{cm}^2$$
$$R_{\text{on}} \approx 100 \text{ m}\Omega$$

At  $V_{\text{gs}} = 15 \text{ V}$

# Switching Loss Comparison of 1200 V / 10 A SiC DMOSFET vs Si IGBT (IRG4PH40KD)

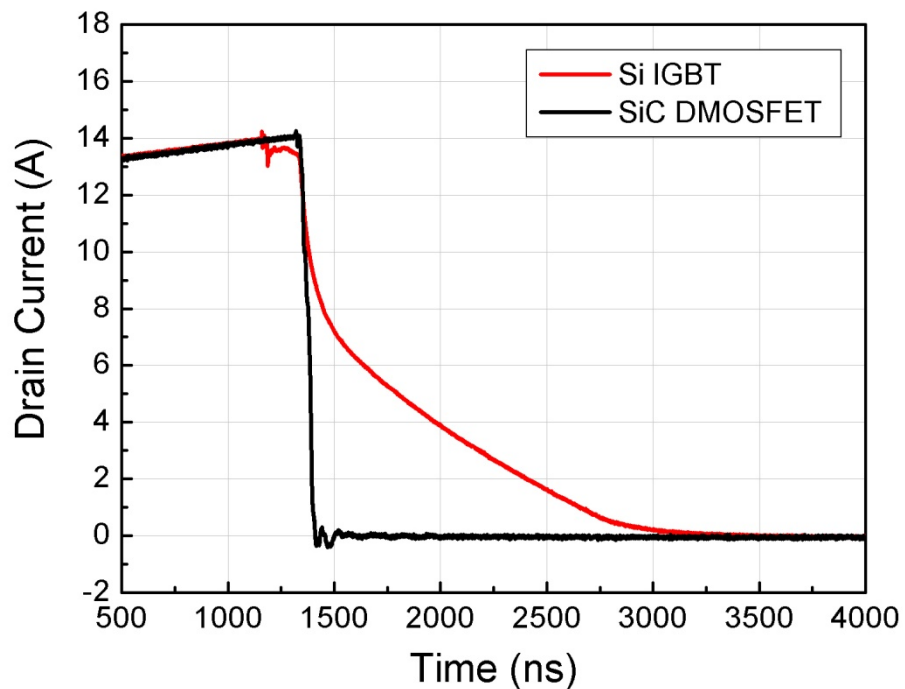

## Switching Losses ( $\mu\text{J}$ )

Temp. ( $^{\circ}\text{C}$ )	Turn On		Turn Off	
	SiC DMOS	Si IGBT	SiC DMOS	Si IGBT
25	423	303	84	973
50	381	335	82	1310
75	369	373	87	1710
100	362	413	96	2240
125	352	455	104	2980
150	348	500	109	3990

**Switching at  $150^{\circ}\text{C}$**

**Switching Energies**

**SiC DMOSFET:  $457 \mu\text{J}$**

**Si IGBT:  $4490 \mu\text{J}$**

# Total Power Loss Comparison of 1.2kV / 10A SiC DMOSFET vs. Si IGBT (IRG4PH40KD)

$$P_{\text{Total}} = \text{On-State Power} + \text{Turn-off Power} + \text{Turn-on Power}$$

$$P_{\text{Total}} = I \cdot V \cdot \text{Duty Cycle} + (W_{\text{off}} + W_{\text{on}}) \cdot \text{frequency}$$

## Calculation Parameters

$T = 150^{\circ}\text{C}$

$I = 10 \text{ Amps}$

Duty Cycle = 50%

**Si IGBT Is Impractical  
at High Frequencies**

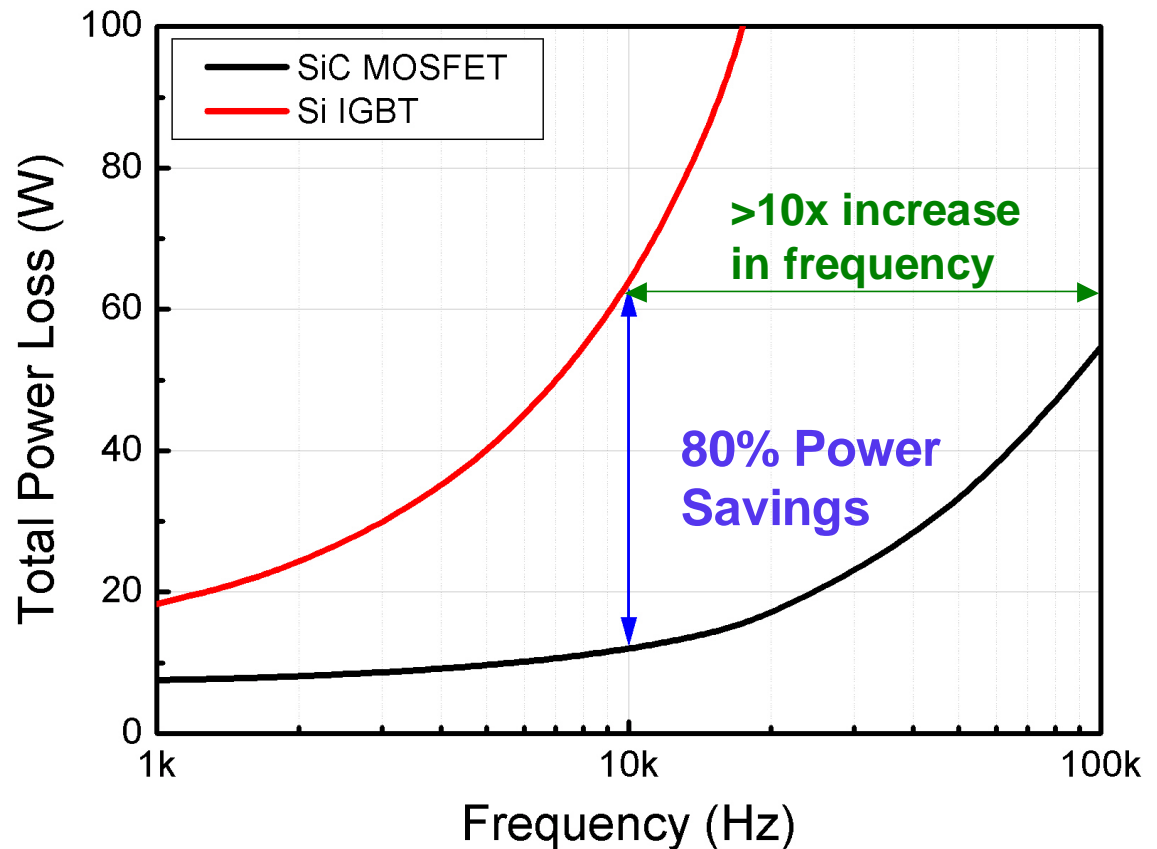

# Dramatic Increase in Efficiency of 3-Phase Solar Inverter Using 1200V SiC DMOSFET

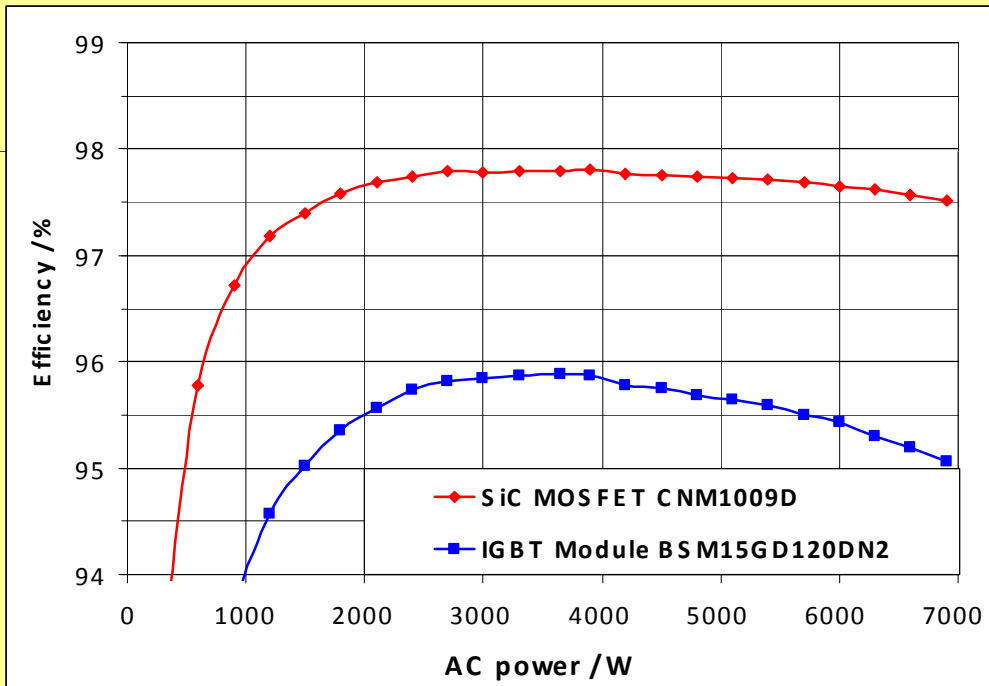
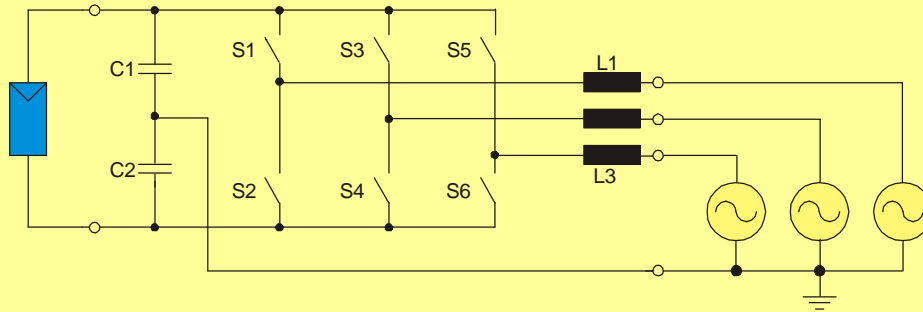

- **2.4% Increase in Efficiency of 3-Phase Solar Inverter Achieved Using Cree 1200V SiC DMOSFET**
- **Replaced 1200V Si IGBTs in Solar Inverter With 1200V SiC DMOSFETs w/o Optimization**
- **Significant Cost Savings**
  - 81 Euro/yr in Northern Europe
  - 164 Euro/yr in Southern Europe

# Scaling up to 1200 V, 60 A DMOSFET

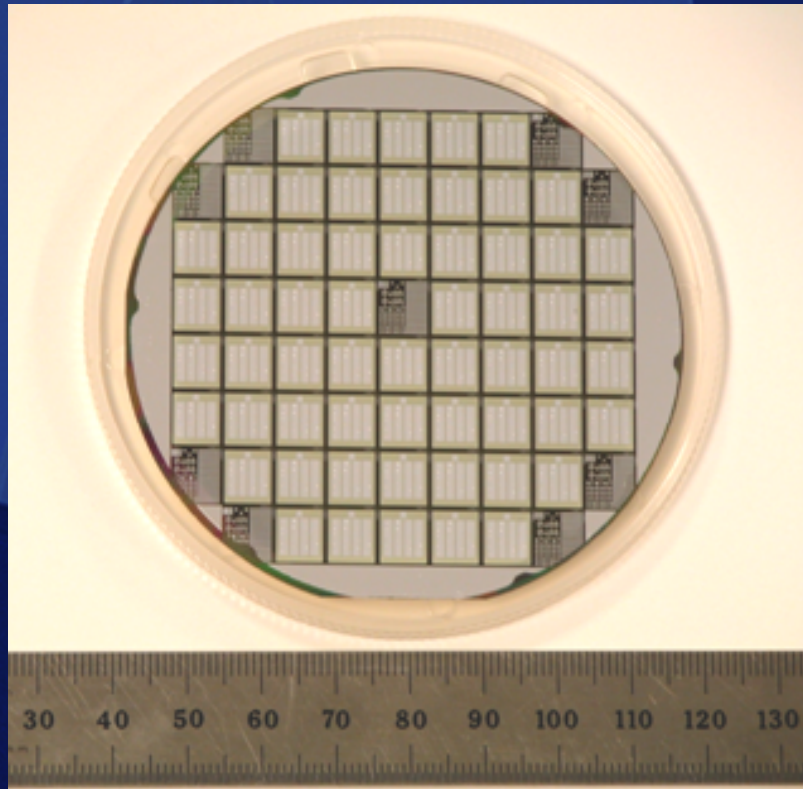

60 Die Per 3 inch Wafer

111 Die Per 100 mm Wafer  
(in progress)

TO-258 Metal Packages  
Four 10 mil Al wires to Source  
Silicone Encapsulant

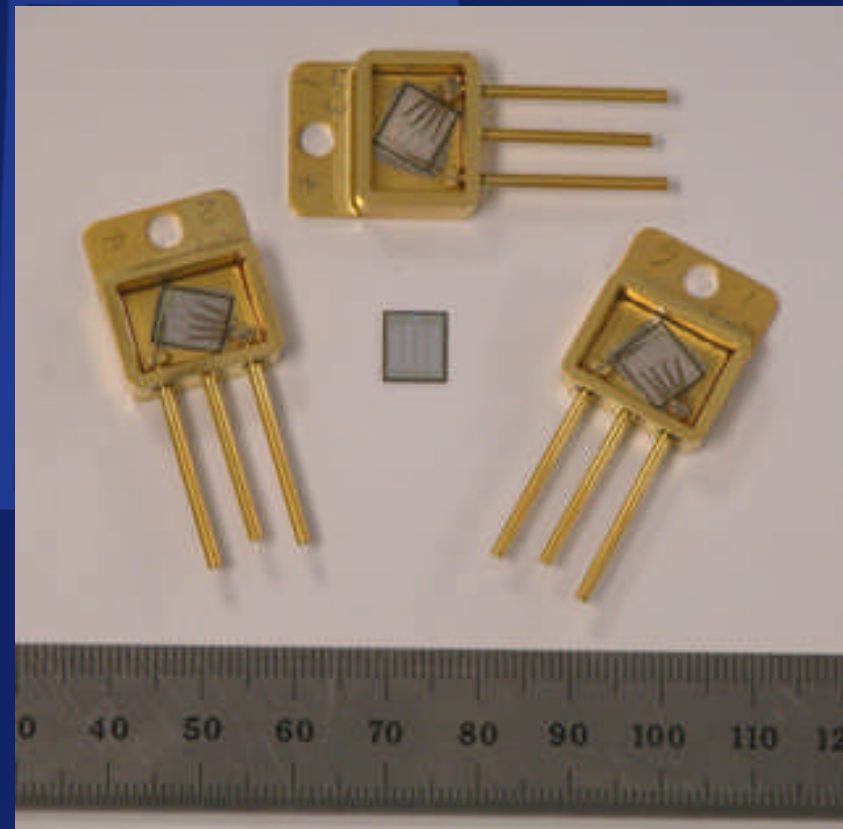





# 1.2kV/100A SiC DMOSFET/JBS Diode 200°C Half H-Bridge Module



- 1.2kV/100A SiC DMOSFET Half H-Bridge Module
- Capable of  $T_j = 200\text{ }^\circ\text{C}$  Operation
- 4x 1.2kV/50A SiC DMOSFETs
- 4x 1.2kV/50A SiC JBS Diodes



1.2 kV/100 A Module

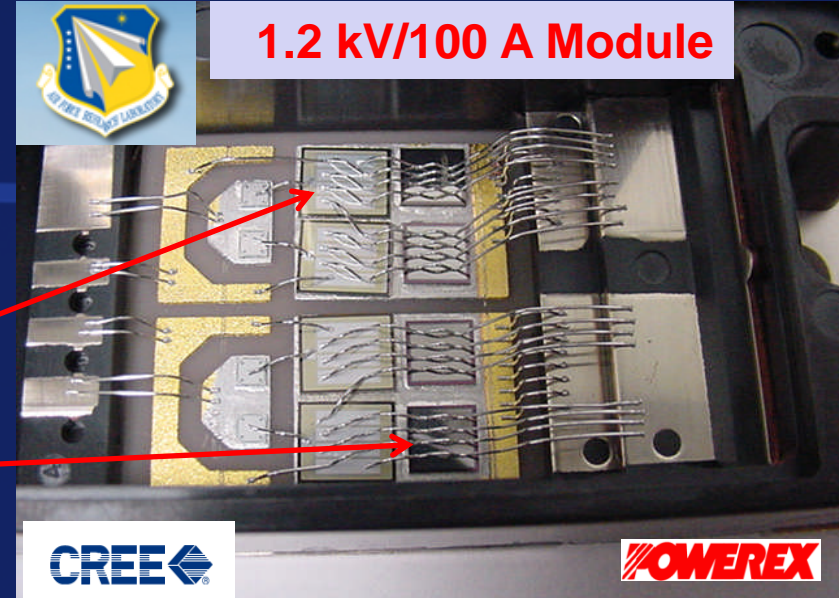

CREE

OWEREX

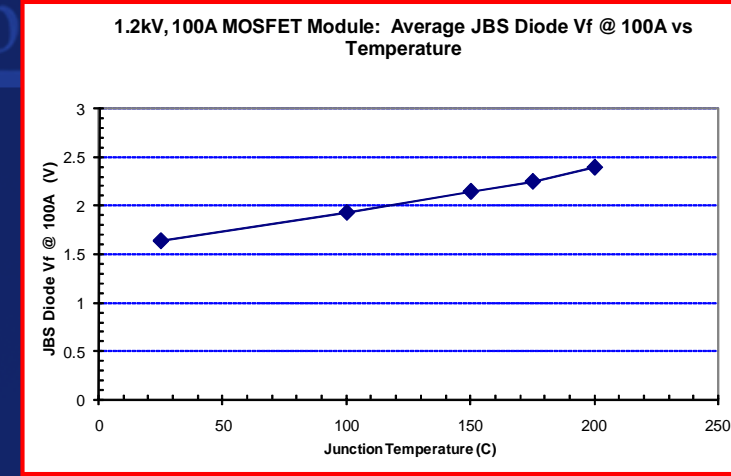
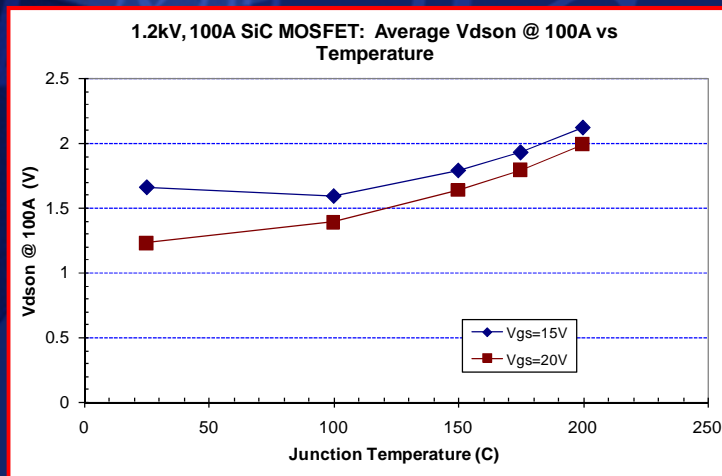

CREE

Creating Technology That Creates Solutions

# Wafer and die photographs of 3200 V 2 A DMOSFETs

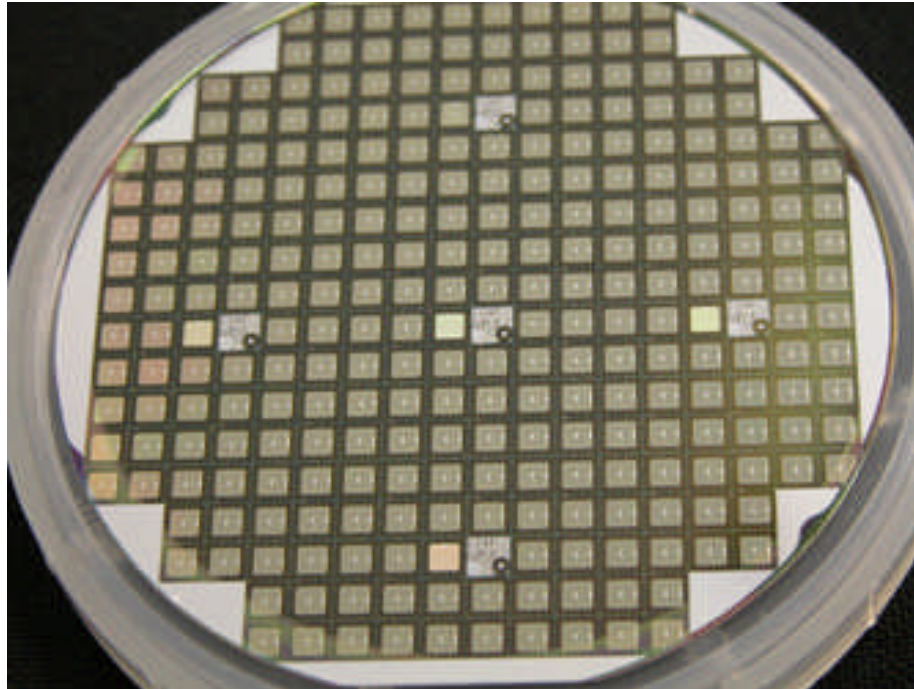

**3.2 kV, 2A DMOSFETs on a 3 inch wafer**

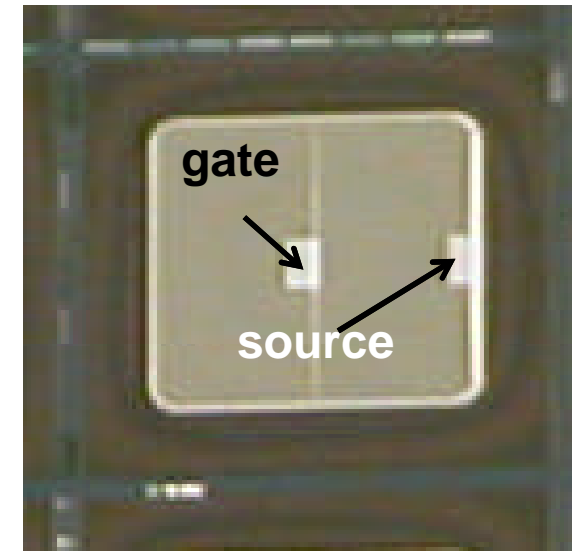

**Chip size: 4 mm x 4 mm  
Active area:  $5.76 \times 10^{-2} \text{ cm}^2$   
including pad areas**

# Room temperature static IV characteristics

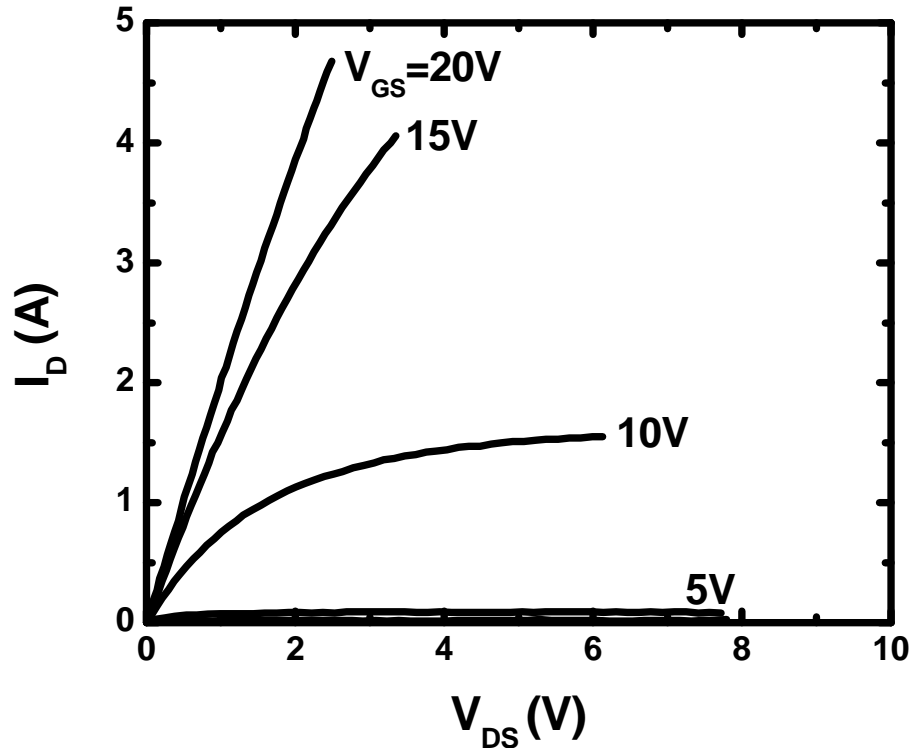

$R_{on, sp} = 35 \text{ m}\Omega\text{-cm}^2 @ V_{GS} = 15\text{V}$   
 $= 28 \text{ m}\Omega\text{-cm}^2 @ V_{GS} = 20\text{V}$

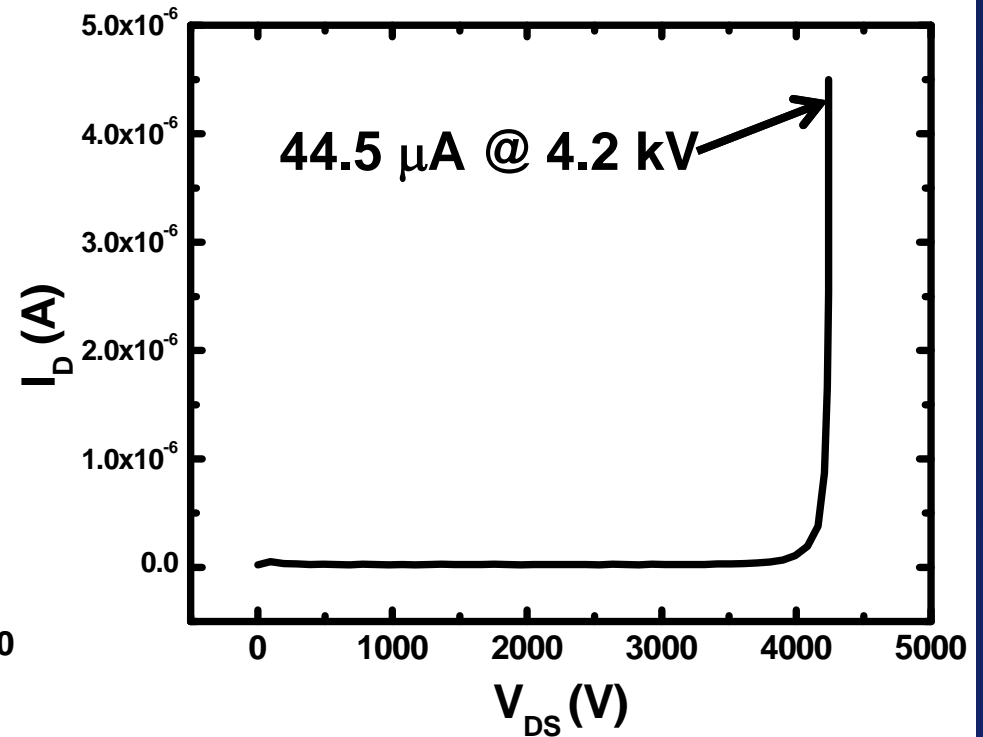

**BV = 4.2 kV with  $V_{GS} = 0 \text{ V}$**

# 3.3kV SiC DMOSFET & 3.3kV Si IGBT Loss Comparison at 125 °C

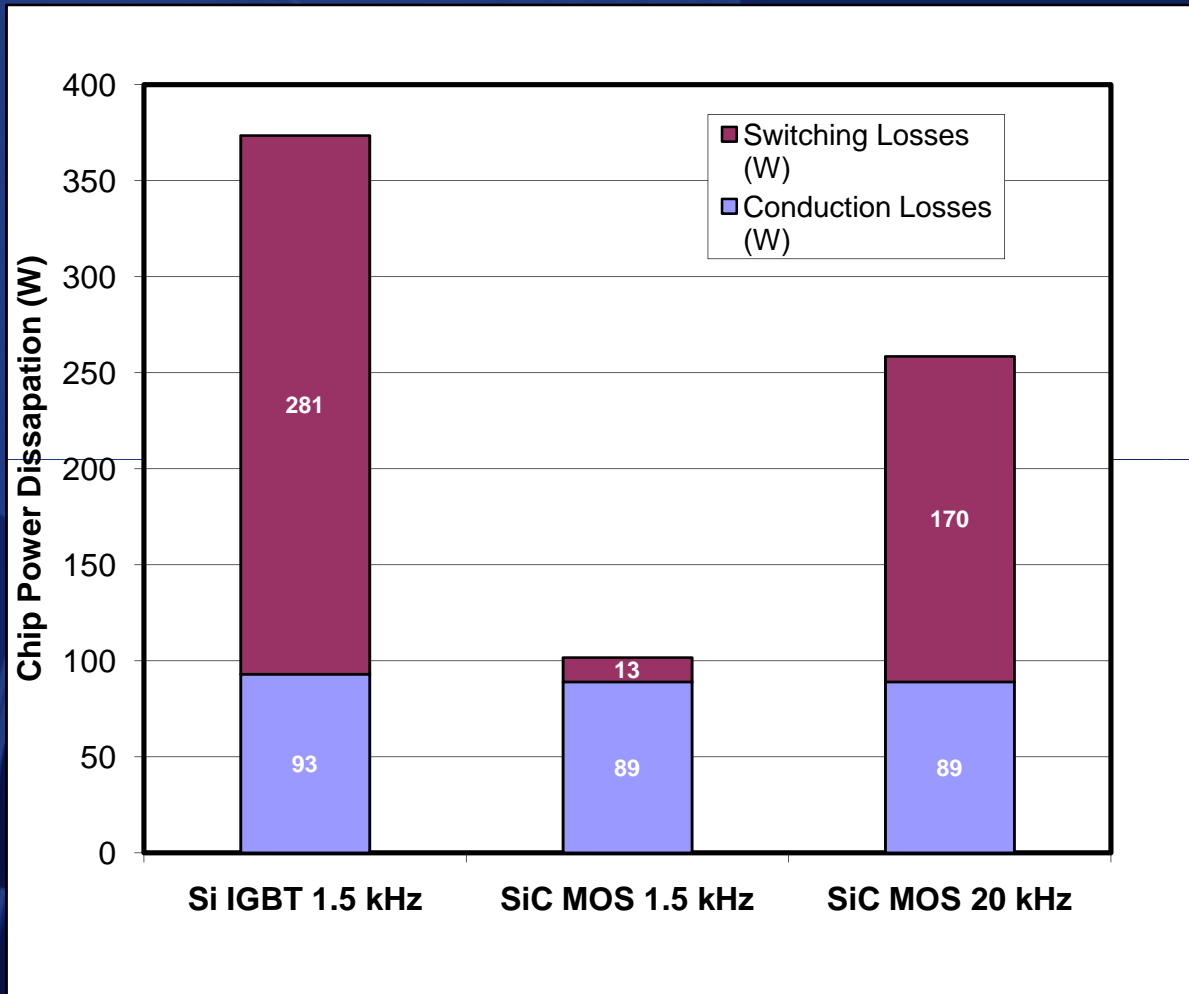

- 3.3kV SiC DMOSFET Switching Losses > 10X Lower Than 3.3kV Si IGBT @ 125C
- 3.3kV SiC DMOSFET Conduction Losses Slightly Lower Than 3.3kV Si IGBT @ 125C
- 3.3kV SiC DMOSFET Capable of 20kHz Switching Operation

## Conditions:

- $I_C, I_D = 62 \text{ A}$
- $V_{CE}, V_{DS} = 1.8 \text{ kV}$
- Duty = 50 %

# High Yield Fabrication of 10kV/10A SiC DMOSFETs

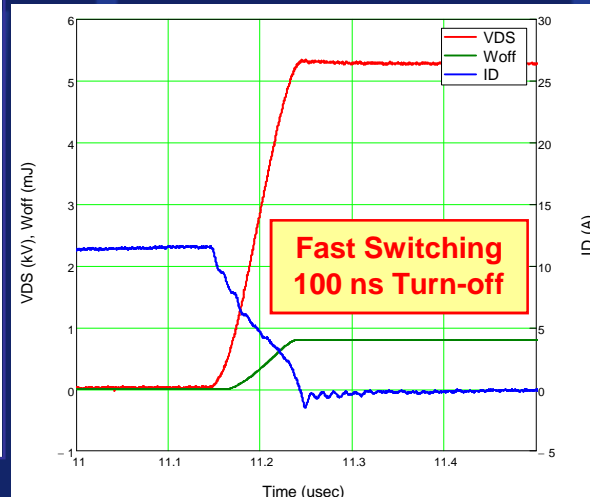
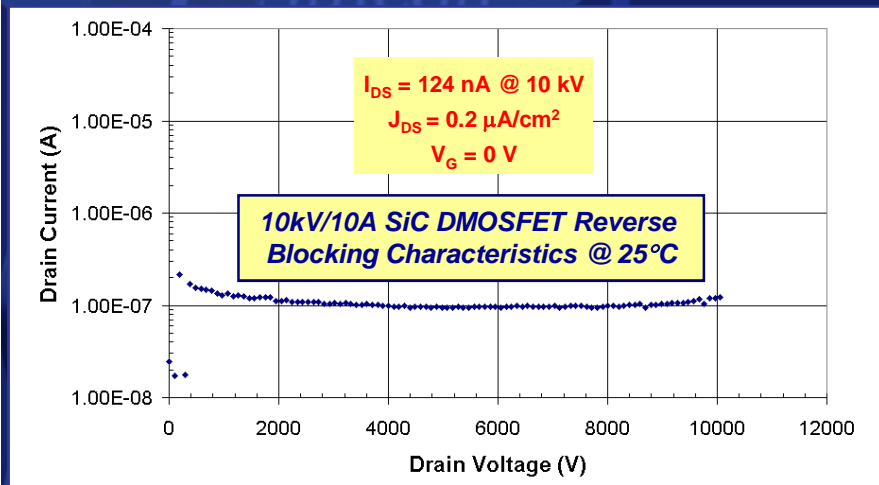
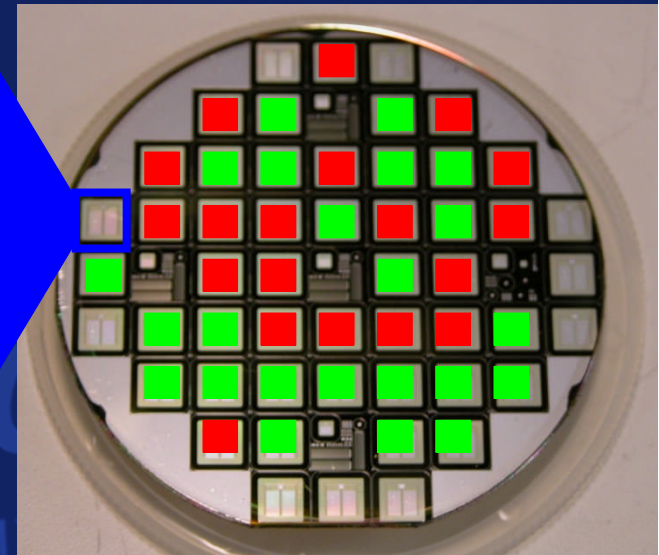
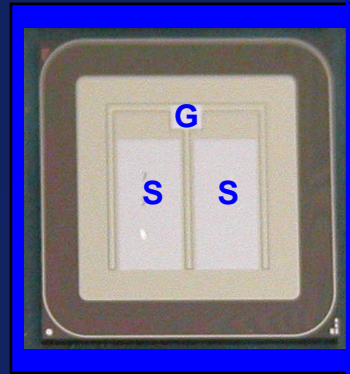
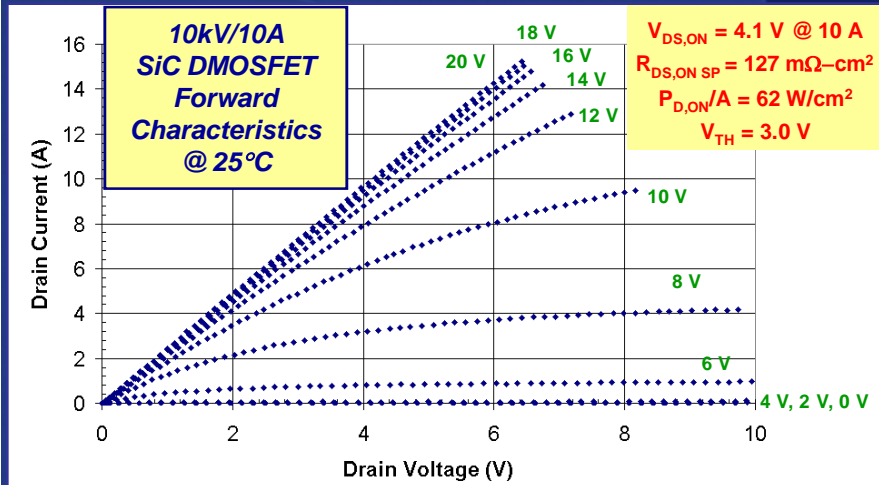

- High Yield Fabrication of 10kV/10A SiC DMOSFETs on 3-inch Wafers
  - 8.1 x 8.1 mm Devices
  - Highest Yield = 55%
  - Green ⇒ Good Device on 3-inch Wafer

Courtesy: Dr. Mrinal Das, CREE



Creating Technology That Creates Solutions



# 500V – 5kV / 20 KHz Boost Converter Using 10kV/10A SiC DMOSFETs and JBS Diodes

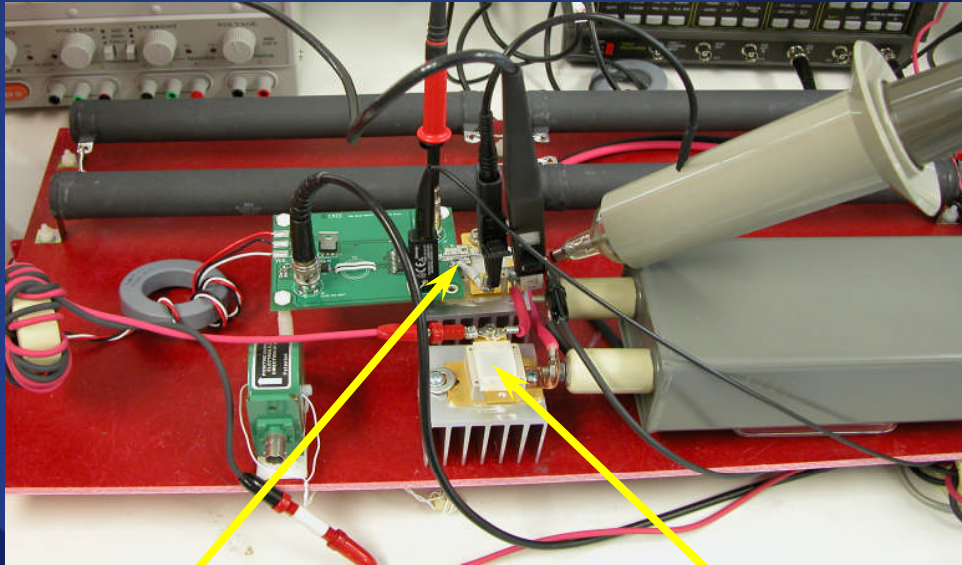

10kV/10A SiC DMOSFET

10kV/10A SiC JBS Diode

<u>Input</u>	<u>Output</u>	<u>Duty Cycle</u>
$V_{IN} = 503 \text{ V}$	$V_{OUT} = 5 \text{ kV}$	90%
$I_{IN} = 1.35 \text{ A}$	$I_{OUT} = 0.12 \text{ A}$	Operating
$P_{IN} = 679 \text{ W}$	$P_{OUT} = 617 \text{ W}$	at 20kHz

- 500V – 5kV Boost Converter Operating at 20kHz
- Maintained > 90% Efficiency Over Full Load Range

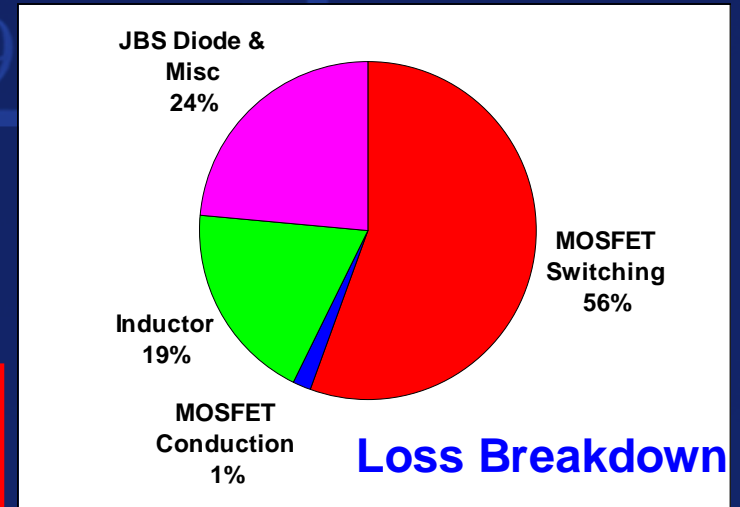
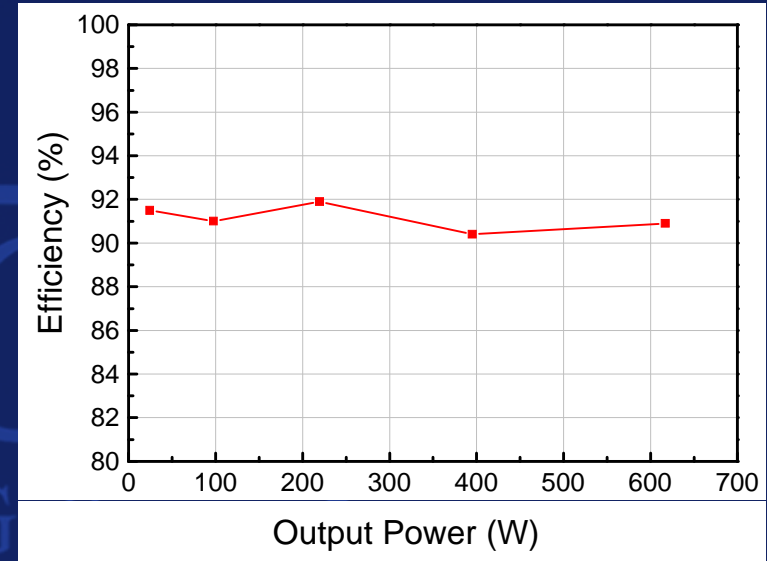

Courtesy: Dr. Mrinal Das, CREE

Creating Technology That Creates Solutions

# DARPA HPE-II 10kV/50A SiC Half H-Bridge Module

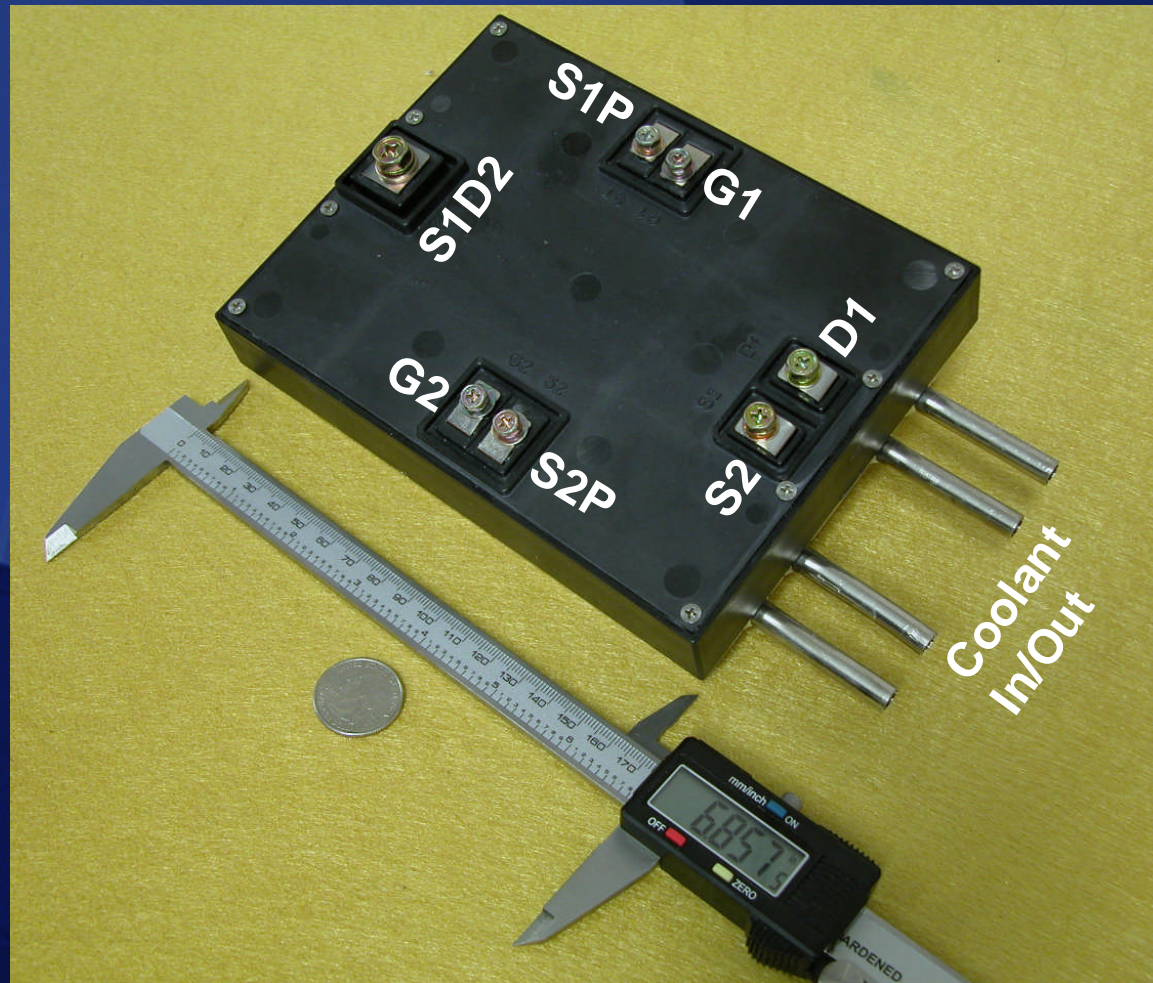

Module Dimensions ~ 7 x 5 inches

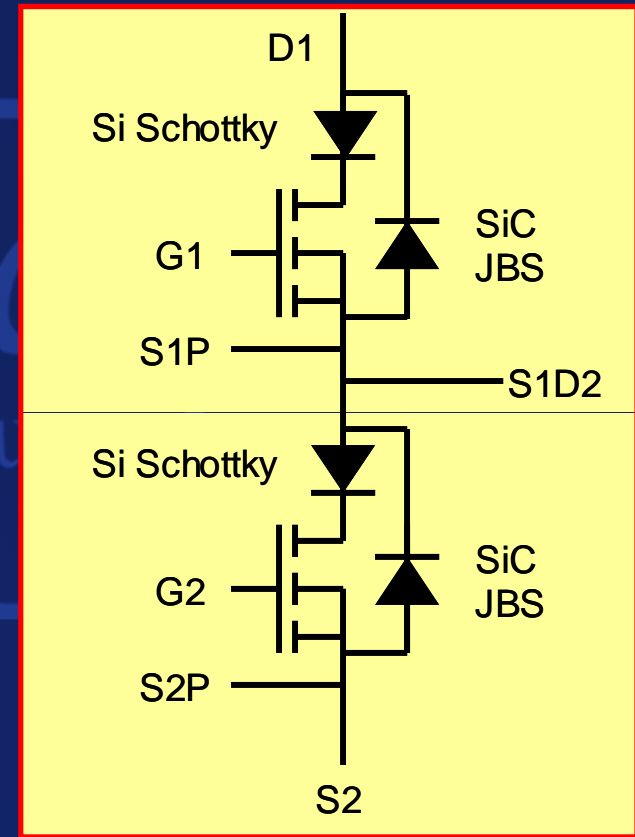

# What Is Next for High Voltage SiC Power Devices?

- **10 kV ~ Upper Limit of SiC Unipolar Devices**
  - DMOSFETs and Schottky diodes
- **Higher Voltage  $\Rightarrow$  Bipolar Devices**
  - Si IGBT Replace Si DMOSFET at  $> 1\text{kV}$
- **For SiC Devices, This Holds True for  $>10\text{ kV}$** 
  - SiC breakdown field 10x that of silicon

**Over ~ 10kV - We Need SiC IGBTs,  
GTOs and PiN Diodes**



# Comparison of SiC n-IGBTs and Si IGBTs

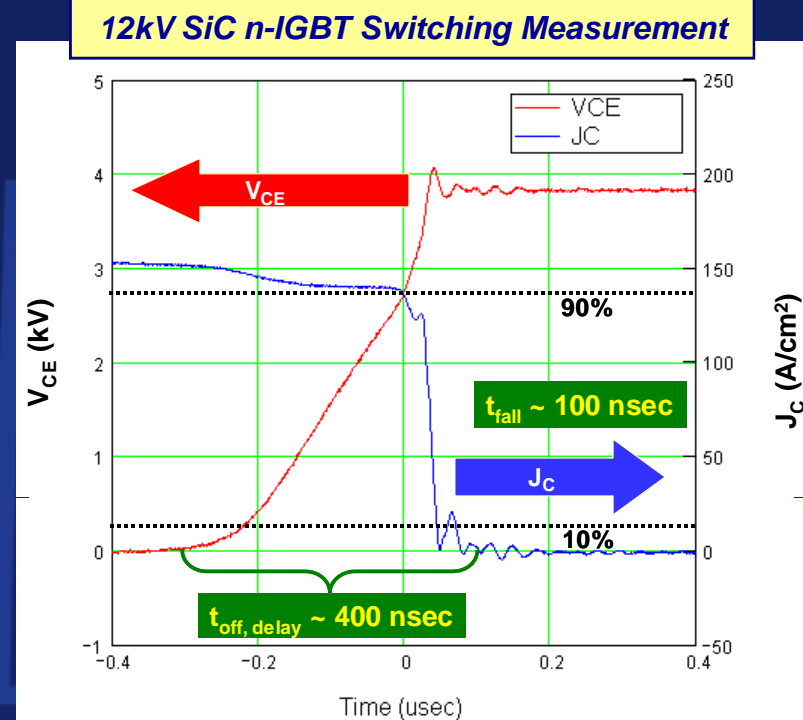
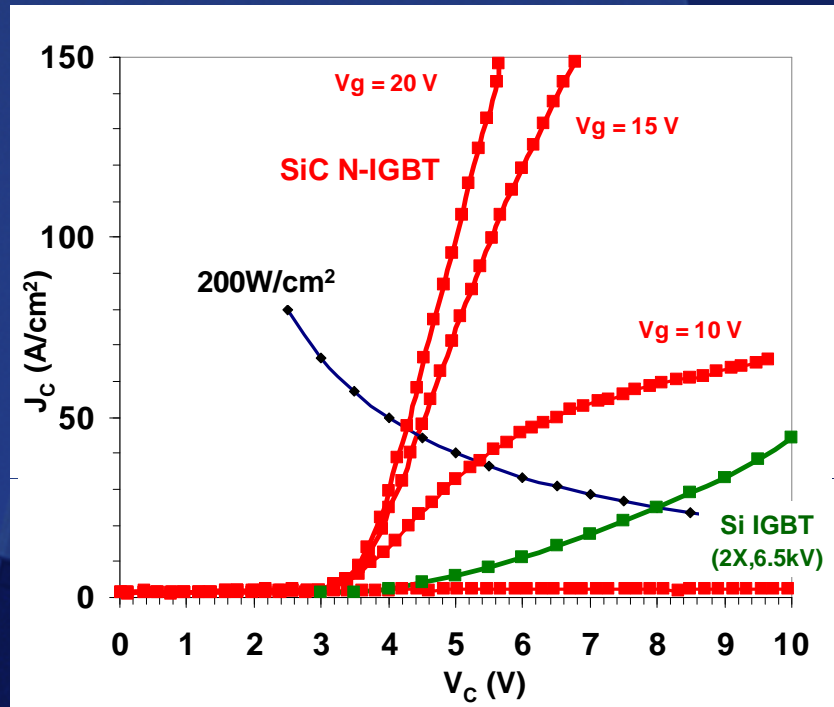

- **SiC IGBTs Are Superior to Si IGBTs at Higher Voltages**
  - 12kV SiC n-IGBTs Have **>3x Lower  $R_{on,sp}$**  Than 6.5kV Si IGBTs
  - SiC n-IGBTs Have Much **Lower Forward Voltage ( $V_F$ ) & Higher Current** Than Si IGBTs at Same BV
  - 12kV SiC n-IGBTs Have **4x Faster Switching Speed** and **>4x Lower Switching Loss** than 6.5kV Si IGBTs

# 12kV SiC n-IGBT Boost Converter

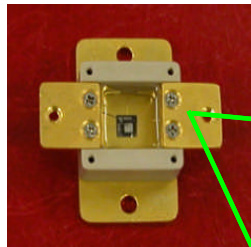

12 kV Large n-IGBT

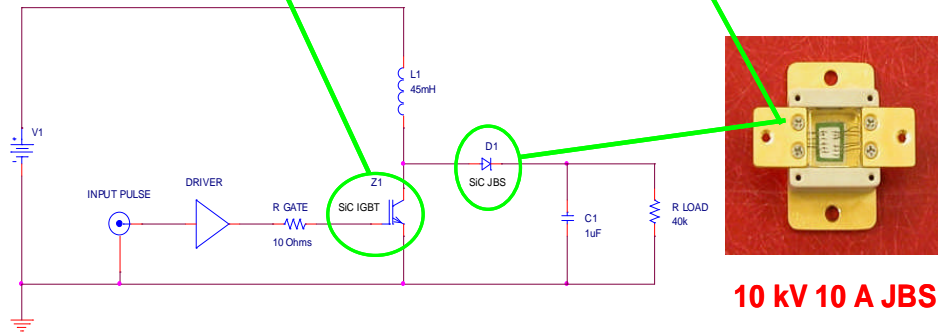
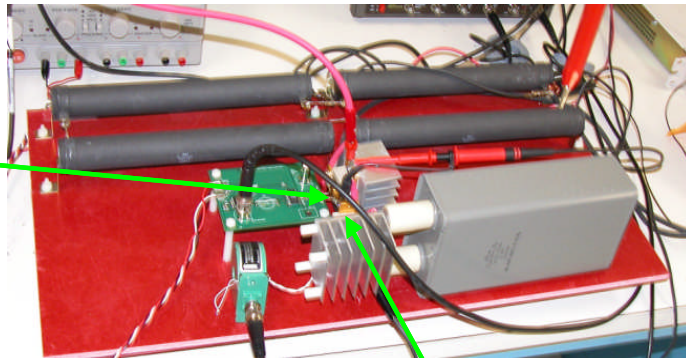

10 kV 10 A JBS

12kV SiC n-IGBTs Used to Demonstrate 5 kV / 5 kHz Boost Converter With 85% Efficiency

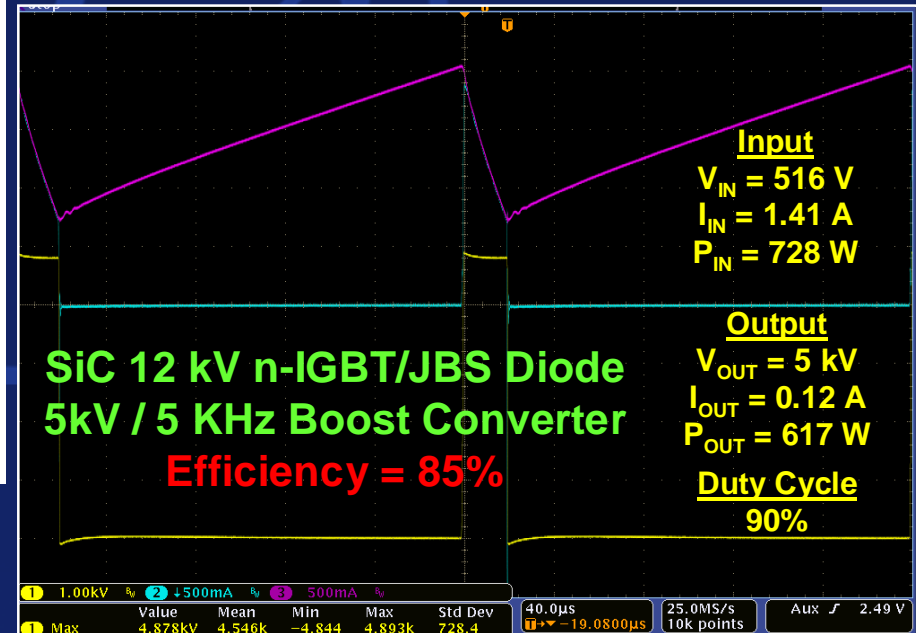

SiC n-IGBT/JBS Diode  
5kV/5KHz Boost Converter

# SiC for High Voltage Devices

- SiC production and reliability proven at low voltages (600-1200V) and running in high volume
- SiC MOSFETs nearing production at 1.2 kV, and 3.2 kV – 10 kV devices are proven and circuit demos show incredible performance
- For higher voltage (>10 kV), GTOs and IGBTs have been demonstrated
- SiC will enable high voltage drive trains with efficiencies and frequencies far in excess of what can be achieved in Silicon



**“That’s nice, BUT we’ll need an environmental-impact study,  
a warranty, recall bulletins, recycling facilities,  
and 24 hour customer service support!”**

Session 8.0



**Compilation of  
Potential R&D  
Areas**

# Prioritization Score Sheet

## INSTRUCTIONS

- Each Registered Attendee is Entitled to Submit 1 Scoresheet file:
  - the total number of points for the scoresheet file must sum to 100 points
  - the points may be distributed freely among the different topics
  - topics will be ranked according to the highest number of points
- Complete your personal information here:
  - Name:
  - Email:
  - Phone:
- Save this file as a Powerpoint 2000-2003 or compatible (not 2007)
- Use the file name: <your last name>-CO2 Scoresheet.ppt
- Email the Powerpoint file to Ron Wolk: ( [WOLKINTTS@aol.com](mailto:WOLKINTTS@aol.com) )

# Prioritization Score Sheet

R&D Categories	Score	R&D Projects Suggested to Support Achievement of Goal To Significantly Reduce Capture and Transportation Costs
<p><b>Properties of CO<sub>2</sub> and Co-constituents</b></p>		<p>Perform more gas properties measurements of CO<sub>2</sub> mixtures</p> <ul style="list-style-type: none"> <li>• Collect experimental PVT and VLE data and develop correlations for systems with 60-100% CO<sub>2</sub>, 0-40% H<sub>2</sub>S, 0-5% Ar, and 0-5% N<sub>2</sub>, H<sub>2</sub>O</li> <li>• Develop an understanding of the impact of Ar and N<sub>2</sub> and the pressure required to obtain dense phase supercritical CO<sub>2</sub></li> <li>• Thermodynamic properties of CO<sub>2</sub> and ranges of impurities expected in CCS applications within vapor dome is liquid (also supercritical)</li> <li>• Variable speed of sound pulsation models (real gas effects)</li> <li>• Provide experimental data of CO<sub>2</sub> and co-constituents properties including (NH<sub>3</sub>, )<sub>2</sub>) at pressures ranging from 5-2500psia and then develop simulation model with experimental data</li> </ul>

# Prioritization Score Sheet

<b>R&amp;D Categories</b>	<b>Score</b>	<b>R&amp;D Projects Suggested to Support Achievement of Goal To Significantly Reduce Capture and Transportation Costs</b>
<b>Properties of CO<sub>2</sub> and Co-constituents</b>		Improve Equations of State <ul style="list-style-type: none"><li>• Equation of State predictions at all pressures with water present at various concentrations</li><li>• Establish standard equations of state usage in analysis</li><li>• Refine equation of state near critical point and with mixtures</li><li>• from 1psia up to 11,000 psia ?</li></ul>
		Define compositions/pressures for power plants, reinjection recycle, pipeline



# Prioritization Score Sheet

R&D Categories	Score	R&D Projects Suggested to Support Achievement of Goal To Significantly Reduce Capture and Transportation Costs
<b>Integration of CO2 Capture and Compression</b>		Evaluate cost/benefits for various CO2 capture options based on various CO2 impurity specs (10 ppm, 50 ppm, 100 ppm, 1000 ppm)
		Optimized integration of a CO2 capture/compression systems together with the power plant
		IGCC Demonstration project with CO2 capture to reduce risk and enhance workability
		Evaluate alternate CO2 compressor drives (steam and gas turbines)
		Integrate utilization of waste heat to improve cycle efficiency

# Prioritization Score Sheet

R&D Categories	Score	R&D Projects Suggested to Support Achievement of Goal To Significantly Reduce Capture and Transportation Costs
<b>Pipeline issues</b>		Perform optimization of pipeline booster stations Station spacing, liquid vs. gas, driver selection
		Perform further corrosion studies on the effects of moisture on pipeline corrosion
		Establish allowable levels of contaminants in CO2 pipeline and/or compressors
		Install test coupons in existing CO2 pipelines to obtain corrosion data, then develop CO2 product specifications including H2O, O2, NH3, TEG, Amines
<b>Other</b>		Determine practical effects of new legislation on CCS (after new legislation is in place)

# Prioritization Score Sheet

R&D Categories	Score	R&D Projects Suggested to Support Achievement of Goal to Significantly Reduce Compression Investment and Power Requirements
<b>Compression Systems Machinery and Components</b>		Design very large axial compressors to provide initial stages of compression followed by conventional HP compressors
		Axial compression system demonstrator for 13 k ton/day
		Integrated back-pressure steam turbine and CO2 compressor
		Comparison and evaluation of compression-liquefaction and pumping options and configurations
		Advanced rotating equipment clearance control and sealing technology demonstration
		Improve reliability of recip EOR recycle compressors, i.e. valve reliability, lubrication
		Compressor heat exchanger data for power plant applications including supercritical fluids
		Document duty cycle requirements for reference plant

# Prioritization Score Sheet

R&D Categories	Score	R&D Projects Suggested to Support Achievement of Goal to Significantly Reduce Compression Investment and Power Requirements
<b>Electric Drive Machinery</b>		Advanced Stator and Rotor cooling schemes
		Improved materials for high speed rotors, advanced design tools
		Tighter integration of compressor, motor and drive components and engineering.
		Determine optimal machine types, speeds, needed voltages, etc. for CO2 compressors
		Advanced Stator and Rotor materials to handle corrosive gases
		Improved drive electronics <ul style="list-style-type: none"> <li>• higher fundamental frequencies for high speed machines</li> <li>• improved controls and bandwidth to provide low torque ripple</li> </ul>
		Higher voltage, higher power, and speed machines and drives.

# Prioritization Score Sheet

R&D Categories	Score	R&D Projects Suggested to Support Achievement of Goal to Significantly Reduce Compression Investment and Power Requirements
<b>Drive Electronics and Components</b>		Development of SiC components and inverter modules for cost effective variable speed drive and cost effective electrically driven compressors <ul style="list-style-type: none"><li>• Manufacturing and cost reduction for SiC power modules</li><li>• Determine and develop optimal device type for CO2 compression application</li></ul>
		Development and demonstration of high voltage, high frequency motor drives
		High voltage, high current module packaging <ul style="list-style-type: none"><li>• Better thermal performance</li><li>• Better reliability</li></ul>
		High frequency transformer magnetic materials: nano-crystalline magnetic materials

# Prioritization Score Sheet

<b>R&amp;D Categories</b>	<b>Score</b>	<b>R&amp;D Projects Suggested to Support Achievement of Goal to Significantly Reduce Compression Investment and Power Requirements</b>
<b>Drive Electronics and Components</b>		Integration of pipeline pumping station motor drive with electrical grid
		Integration of CO2 compression electric drive with power plant electrical system

# Prioritization Score Sheet

## Total Score Points and Scoring Comments

<p>Please Sum Your Total Points of all Scores</p> <p><b>Must = 100</b></p>	<p>Mark your total points here</p>
--	------------------------------------

Comments on topics and scoring:



Acknowledgements



The organizers would like to thank the following people for their contributions to the workshop and proceedings:

Colleen Hood, Terri Kroft, Tam Duong, José M. Ortiz-Rodríguez, Madelaine Hernández-Mora, Brian Grummel, Nanying Yang, and Dean Smith.