

The Propagation and Attenuation of Surge Voltages and Surge Currents in Low-Voltage AC Circuits

François D. Martzloff
General Electric Company
Schenectady NY
f.martzloff@ieee.org

Reprinted, with permission, from *IEEE Transactions on Power Apparatus and Systems*, PAS-102, May 1983
First presented at IEEE Summer Meeting, San Francisco, July 1982
Also reprinted as “High Interest Paper” in *IEEE Power Engineering Review*, January 1984
Paper Award, 1985, Surge-Protective Devices Committee

Significance:

Part 4 – Propagation and coupling of surges

Examples are given showing the propagation of voltage and current surges in low-voltage wiring systems. The difference between surge impedance (characteristic impedance Z_0) of a transmission line and the impedance to the surge of wire runs is pointed out and illustrated.

The relationship between front time/duration of a voltage surge on the one hand, and the travel time (length-related) along the circuit, on the other hand, is placed in the perspective of transmission line theory and makes clear the point that the classical doubling of an impulse at the end of an open line requires a travel time greater than the front time of the impulse.

A comparison is made between the propagation of a surge through isolating transformers and through a ferro-resonant line conditioner. The isolation transformers do not provide effective attenuation of voltage surges in the differential mode but the ferro-resonant line conditioner does, in addition to its prime function of voltage regulator.

For current surges of the type encountered in AC power circuits (not short pulses), their propagation is impeded – as in “impedance” – not by the characteristic impedance of the line nor appreciably by skin effects, but mostly by the inductance of the line for a frequency spectrum in the range of 5 kHz to a few hundred kHz. This provides some relief for SPD connected at the end of branch circuits. The issue was revisited and confirmed several years later in the 1995 “Upside-Down House” experiments (see file “Upsdown measure” in this Part 4)

The effects of connection options are shown for one, two or three SPDs connected at the end of a 3-wire line.

THE PROPAGATION AND ATTENUATION OF SURGE VOLTAGES AND SURGE CURRENTS IN LOW-VOLTAGE AC CIRCUITS

F.D. Martzloff, Senior Member
Corporate Research and Development
General Electric Company Schenectady,
Schenectady, New York

Abstract — Examples are given showing the propagation of voltage and current surges in low-voltage wiring systems. The difference between surge impedance (characteristic impedance) of a transmission line and the impedance to the surge of wire runs is pointed out and illustrated. A comparison is made between the propagation of a surge through an isolating transformer and a ferro-resonant line conditioner. The effect of connection options are shown for one or several surge protective devices connected at the end of a 3-wire line.

INTRODUCTION

Considerable progress has been made during the last decade toward recognizing the occurrence of surge voltages in low-voltage circuits, particularly in ac power circuits; at the same time, improved protective devices have become available. New standards and guides have been published on the subject [1-5], but practical information is still scarce on the propagation of these surges in circuits. In fact, misconceptions are sometimes encountered, such as an expectation that surges will always attenuate substantially as they propagate in the wiring system of a building or through transformers.

This paper provides concrete examples on the propagation of surges and on some possible means to divert or attenuate them, from which some conclusions can be drawn and sound practices recommended.

The tests reported here have been performed with the voltage and current waveshapes recommended by the recently published "IEEE Guide for Surge Voltages in Low-Voltage AC Power Circuits," IEEE Std 587-1980.

Starting from the basic propagation of a pulse along a transmission line, the examples show how real wiring systems differ from an idealized transmission line, how complex systems transform pure standard waves, and how some connection practices for surge protective devices can introduce adverse effects by producing residual voltage surges between conductors. Merits and misconceptions regarding isolating transformers are compared with ferro-resonant line conditioners which, in addition to their regulating function, block the propagation of fast transients, such as the IEEE 587 ring wave.

This paper does not propose to present a comprehensive treatment of surge suppression, but rather to show how the propagation of surges affects the voltages appearing at the loads. The examples reported are given in order to alert the reader against some pitfalls resulting from occasional misconceptions observed by the author during discussions and reviews of many surge-related problems.

TEST CIRCUITS AND TEST GENERATORS

The test circuits selected to represent typical low-voltage ac circuits include runs of nonmetallic jacketed 600 V wire such as that found in residential wiring and runs of rigid conduit with wires pulled in the conduit, such as that found in industrial installations. In these tests, all use two-conductor configurations with a third grounding wire, AWG #12 size (2.05 mm dia.).

The test waves, in accordance with IEEE Std 587-1980, include the $0.5\mu\text{s}$ - 100 kHz voltage ring wave, the $1.2/50\mu\text{s}$ voltage impulse, and the $8/20\mu\text{s}$ current impulse. The $0.5\mu\text{s}$ - 100 kHz wave is produced by a KeyTek 424 surge generator, capable of superimposing the voltage pulse at a controllable time of the 60 Hz line voltage, with crest up to 6 kV (Figure 1). The $1.2/50$ impulse is produced by a Haefely P6R generator, capable of supplying up to 6 kV (Figure 2). The $8/20$ impulse is produced by the same KeyTek 424 with a different plug-in unit (Figure 3) or by a laboratory circuit using storage capacitors and an ignitron switch. The initial test involving transmission line propagation is made with a narrow pulse obtained from a Velonex 350 pulse generator.

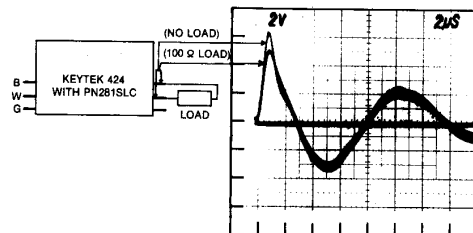

Figure 1. Test waves of $0.5\mu\text{s}$ - 100 kHz, open circuit and loaded, produced by KeyTek 424 generator and PN281LSC plug-in

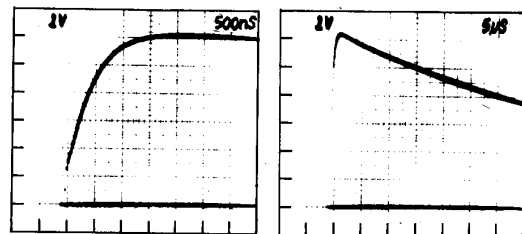

Figure 2. Test wave of $1.2/50\mu\text{s}$, open circuit, produced by Haefely P6R pulse generator

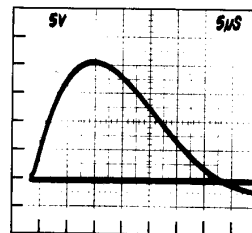

Figure 3. Test waves of $8/20\mu\text{s}$, short circuit produced by KeyTek 424 pulse generator with PN247 plug-in

The oscillograms were recorded with a Tektronix 7633 oscilloscope. Voltage measurements were made with two 1000:1 Tektronix P6015 probes in differential configuration, so that the display calibration of the oscillograms is to be multiplied by 1000. Current measurements were made with a 0.010 Ω T&M Research coaxial shunt, so that the display calibration is to be multiplied by 100 A/V.

The oscillograms are shown together with a schematic of the circuit configuration. The three wires of the various lines are shown as B (black), W (white), and G (green), with the usual convention on color. The impulse was applied between the point shown by the lightning bolt and the ground symbol. The points of connection of the differential probes and the resultant recording are connected by the arrows.

PROPAGATION OF VOLTAGE SURGES

Transmission line behavior

To establish the baseline of the propagation characteristics, a 75 m line of 2-wire plus ground nonmetallic plastic jacket cable is subjected to pulses of 100 ns duration, with the voltages measured at the sending end and at the receiving end of the line. Figure 4 shows the oscillograms recorded at the sending end, with the outgoing pulse and the reflected pulse appearing 740 ns later, from which a propagation speed of 150 m/740 ns, or 200 m/ μ s, can be computed. As a side experiment, the classical nonreflection obtained by terminating the line with a resistance equal to the line surge impedance* is also observed for a terminating resistance of 100 Ω . The slight mismatch indicated by the small reflection remaining, even with the optimum value of 100 Ω termination, is attributable to the connection of the line with closely spaced wires fanning out to the ends of the noninductive wire-wound resistor card. Resistor cards of 90 Ω and 110 Ω produce a positive-going or a negative-going reflection, respectively, indicating that the matching impedance is between these two values.

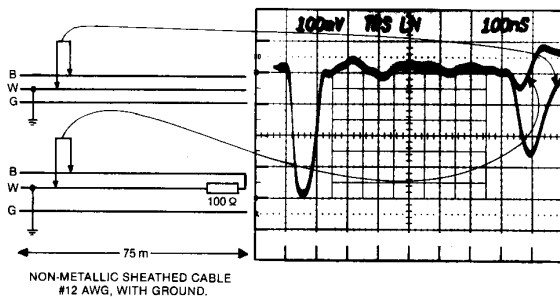

Figure 4. Transmission line behavior of non-metallic, plastic jacket wire

From this first test, we can draw the conclusion (predictable, but too often not recognized in qualitative discussions of reflections in wiring systems) that it is not appropriate to apply classical transmission line concepts to wiring systems if the front of the wave is not shorter than the travel time of the impulse. For a 1.2/50 μ s impulse, this means that the line must be at least 200 m long before one can think in terms of classical transmission line behavior. In the next example, we can observe reflections on the front of the impulses, but they are not significant to the final voltages at the crest values of the impulses.

Short lines behavior

The response of lines shorter than the 200 m limit identified above is illustrated in Figures 5 and 6. Figure 5 shows the response of a 25 m line of nonmetallic plastic jacket wire to a 1.2/50 μ s impulse; Figure 6 shows the response of conduit-enclosed wires to the same impulse, for the same line length.

* A difference between *surge impedance* (also known as "characteristic impedance") and *impedance to the surge* will be discussed in the section dealing with current surges propagation.

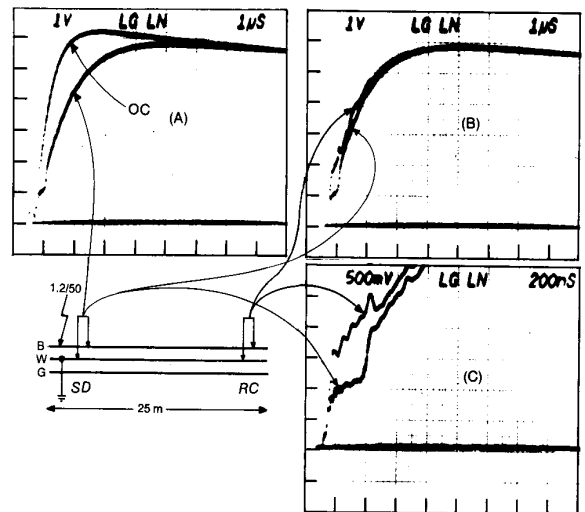

Figure 5. Response to a 1.2/50 μ s impulse of wiring in non-metallic jacket
(A) Output of unloaded generator and with line connected
(B) Sending end and receiving end, open receiving end
(C) Expanded trace of oscillogram (B)

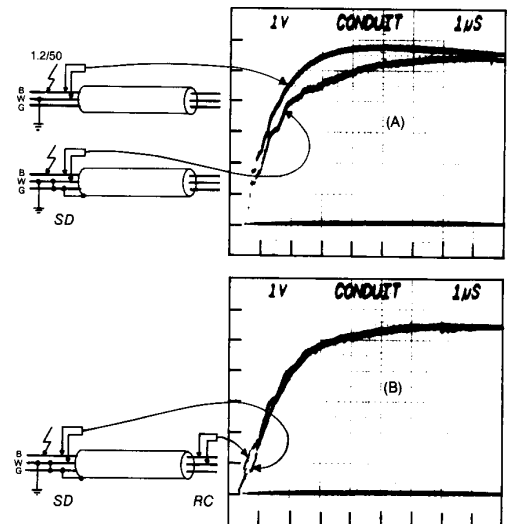

Figure 6. Response to a 1.2/50 μ s impulse of wiring in metal conduit
(A) Effect of grounding options at the sending end
(B) Sending end and receiving end voltages

In both Figures 5 and 6, the front of the wave (SD side) is slower than 1.2 μ s (OC); this effect is caused by the line impedance loading the impulse generator. It is even more noticeable in Figure 6(A), which shows the voltages at the sending end for the connection with white, green, and conduit tied together. The greater capacitance of this configuration, compared to white only at ground, produces a greater load on the generator, including the multiple reflections occurring at the mismatches produced by a conduit fitting at the mid-point of the conduit run; hence, the jagged appearance of the oscillogram.

The front of the impulse is further expanded in Figure 5(C), showing the difference between the sending and receiving ends of the line. Nevertheless, for an open-end line, as shown in Figure 5(B), the final voltage crest is not affected by the reflections occurring during the rise time of the impulse. Likewise, the slight differences between the sending end and the

receiving end occurring early in the rise do not affect the final voltage at the receiving end of the conduit line.

These tests show that the propagation of voltage surges in *open-enc'* lines of lengths likely to be encountered in buildings does not produce appreciable attenuation of the surges, nor does it cause a voltage buildup by reflection of the surges. This fact is significant for the case of an appliance or industrial equipment with a control circuit drawing very little load while the power circuit being controlled is off. During the on cycle of the power circuit, there will be some attenuation of the surge by the combined effect of the line impedance and load impedance, but that beneficial effect is not available during the off-cycle of the power circuit with standby condition of the control circuit, the very circuit containing the most sensitive electronic components of the appliance or equipment.

Branched circuits

Departing further from the simple and sanitary behavior of a transmission line, a still simplified branch circuit behavior is illustrated in Figure 7. In this semi-idealized case of a real circuit, a 10 m line feeds 4 branches, each 10 m long. Three of the branches are left open ended, and the fourth has a heavy load — a short circuit. The interaction of this circuit with the impulse generator, set for the 1.2/50 μ s impulse of Figure 2, produces the wave shown at the sending end, while the voltage at one of the open receiving ends goes through oscillations that only vaguely resemble the sending-end wave shape; of course, the idealized unidirectional impulse has vanished.

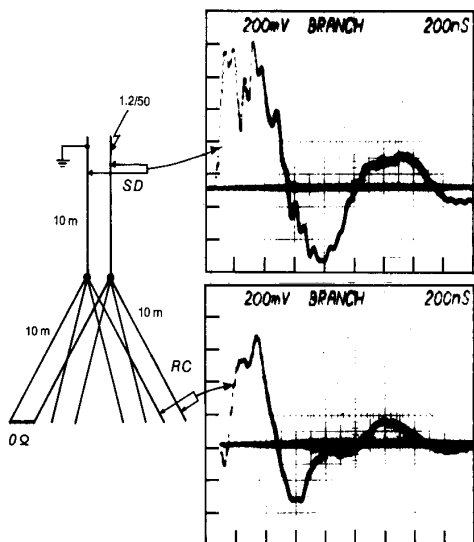

Figure 7. Response to a 1.2/50 μ s impulse of a branched circuit

This simple branch circuit behavior demonstrates why it would be an illusion or fallacy to cling to the concept that nature can be simulated with simple test waves.*

* This dichotomy between simulating nature and performing standard tests has been recognized [6,7], but still needs to be emphasized. A test wave is applied to a device, not to demonstrate that it can survive any of the waves that it will encounter in nature, but only to demonstrate for the benefit of both manufacturer and purchaser that the device can survive an agreed-upon, arbitrary, simple, clean impulse. From surviving the test impulse, the inference is made, *subject to confirmation by field experience*, that the device does have the capability to survive the infinite variety of surges that it will encounter during its life in the real world. In other words, simple (and clean) test waves are useful because they can be reproduced over a period of time at the same facility, and between different facilities, providing a common language and a standard of comparison that is essential to conduct orderly transactions. Test waves should *not*, however, be misconstrued as representing natural phenomena. They are "realistic" (which is not the same thing as "representing reality") only to the extent that the conclusion drawn from surviving the test wave is validated by better survival in the field than for those devices that do not survive the test wave.

Does an isolating transformer help?

The author has witnessed and engaged in many discussions on the merits of isolating power transformers, sparked by the misconception indicated by statements such as "spikes are attenuated by transformers" or "spikes do not pass through transformers." Figures 8 through 12 are offered to support the position that these quotations are misconceptions. When properly applied, isolating power transformers are useful to break ground loops, but they do not by themselves attenuate surges that occur line-to-line or in the normal mode.

Figure 8 shows the propagation — or worse, the enhancement — of a voltage impulse in a 1:1 isolating power transformer. The 6 kV impinging ring wave appears as 7 kV crest on the secondary side of this "isolating" transformer.

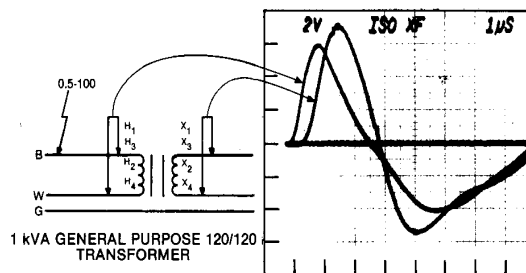

Figure 8. Propagation of a 0.5 μ s - 100 kHz ring wave through an isolating transformer

Figure 9 shows similar behavior in a transformer offered as a "line isolator." This product is intended to provide ground loop isolation and low effective capacitance between primary and secondary windings, but here again, the author has observed that users of this device expect *attenuation* of surges. The response of this isolator, due to its internal construction, is different from that of the simple two-winding transformer of Figure 8, but we also note that a crest of 8 kV occurs on the secondary side, during the second half-cycle. Hardly an improvement.

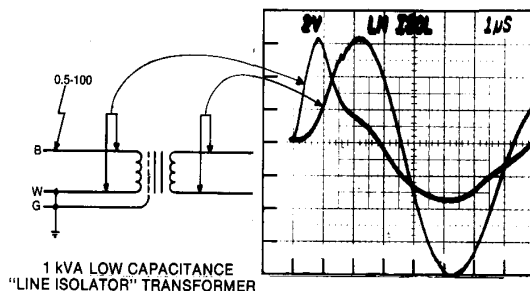

Figure 9. Propagation of a 0.5 μ s - 100 kHz ring wave through a "line isolator" transformer

Figures 8 and 9 were recorded with no load on the transformer secondary, which represents the extreme case of a low-power electronic control in the standby mode. Figure 10 shows the primary and secondary voltages of the transformer with a 10 W (1500 Ω) and a 100 W (150 Ω) load on the secondary side, at the same generator setting as Figure 8. With the 10 W load that might be typical of an electronic control in standby mode, the combined series reactance of the transformer and shunt resistance of the load produce the output shown in Figure 10(A), still slightly higher than the input.

With the 100 W load shown in Figure 10(B), the attenuation is now apparent, but is only 2:1. Capacitive loads would, of course, produce a greater attenuation than resistive loads for the inductive series impedance of the transformer, at the frequency spectrum of this fast 2 μ s-wide surge. For surges of longer duration, the attenuation would be smaller.

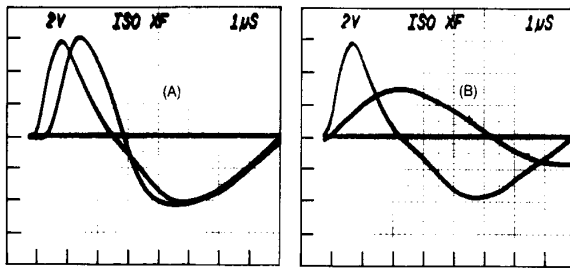

Figure 10. Effect of loading on the secondary side

These examples show that, unless a well-defined load is connected to the transformer, expecting attenuation from the transformer may prove to be hazardous to the health of low-power electronics connected on the secondary side of the transformer.

In contrast, decoupling of the surge is possible with a ferro-resonant line conditioner, which is primarily intended for line voltage regulation, but which also provides a high degree of surge suppression. Figure 11 shows a 6 kV impinging ring wave attenuated to 60 V (100:1) on the secondary side of the unloaded line conditioner, and to 40 V (150:1) with a load of only 10%; at full load, less than 10 V was observed. The nature of the ferro-resonant line conditioner is such that the decoupling improves with loading, while the simple transformers of Figures 8, 9, and 10 can only act as linear dividers with load changes. Conversely, the decoupling between primary and secondary sides of the line conditioner is further seen on the oscillogram recorded on the input side of the line conditioner. This oscillogram is, in fact, a photograph of two successive measurements, one with no load on the line conditioner and one with a 100 W load. The input waves are exactly superimposed. Compare this with the regulation of the generator output voltage noticeable in Figure 1, where a 100 Ω resistor is connected directly at the terminals of the generator.

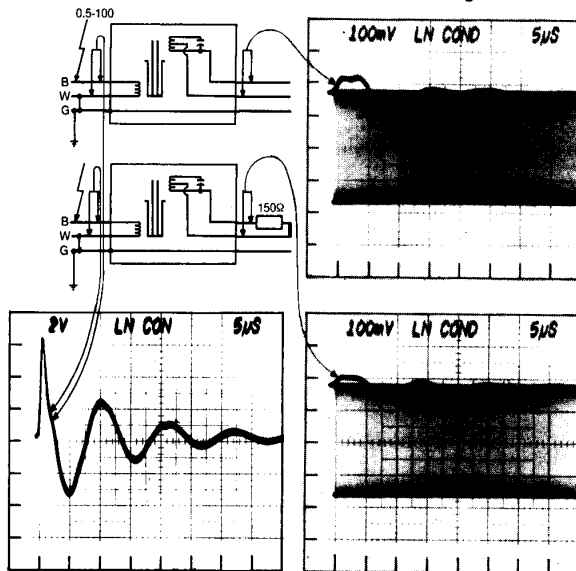

Figure 11. Decoupling of a 0.5 μ s - 100 kHz ring wave by a ferro-resonant line conditioner

This decoupling reflects the nonlinear behavior of the ferro-resonant line conditioner, which is significant in this case, compared to the linear behavior of transformers: for surge sources of lower impedance than the generator used in these tests, or for frequencies lower than those contained in the 0.5 μ s - 100 kHz ring wave, the transformer attenuation would become lower, in direct proportion to the corresponding impedance change, while the ferro-resonant transformer would keep the decoupling unchanged.

The two oscillograms of the output were recorded with the surge timed to occur at the peak of the 60 Hz line voltage, for worst-case demonstration. The peak-to-peak amplitude of the line voltage is indicated by the gray band recorded on the oscillograms by photographically superimposing repetitive traces of the line voltage. For timings other than the peak, the small voltage oscillation on the output voltage would be completely contained within the normal peak-to-peak band of the 60 Hz line voltage.

While these measurements were being taken, an additional observation was made. Figure 12 shows the response of the line conditioner to surges occurring at different times in the 60 Hz cycle, as indicated by the different vertical position of the traces at their beginning. The ferro-resonant mechanism is responsible for this different response. In itself, this is not very important in the present context, but it does provide another example of the importance of performing surge testing at different angles along the power-frequency cycle (as recommended in the discussions presented in IEEE Std 587) because the outcome of the test may be influenced by the timing of the surge.

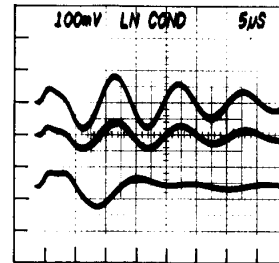

Figure 12. Effect of timing of the surge with respect to the power frequency voltage

PROPAGATION OF CURRENT SURGES

Line impedance: surge impedance or impedance to the surge?

As mentioned in the transmission line behavior, a distinction has to be made between two concepts that unfortunately can be confused because of the language: surge impedance of the transmission line, and impedance of the line to the surge. The first is the classical transmission line parameter, also called "characteristic impedance", $Z_o = \sqrt{L/C}$, and applies for long lines and short pulses. It is independent of the line length and frequency. The second, impedance to the surge, is indeed dependent on the line length, and is the impedance of the complex (real and imaginary) network of distributed parameters, R,L,C, of the wiring configuration. This impedance is also dependent on the frequency, so that rigorous analysis would involve computation over the frequency spectrum of the impulse of interest. For practical applications, it would be more convenient, although not rigorous, to define the impedance of a line to the surge as the ratio of voltage to current, stating the current wave form.

Thus, inspection of Figure 13 shows a current crest of 400 A flowing in the line with shorted end and a voltage crest of 1700 V at the sending end, with a current wave form of 25/70 μ s. It is noteworthy that the short-circuit impulse of 8/20 μ s produced by the generator has been stretched out by the effect of the line impedance. This impedance is mostly inductive, as shown by the fact that the crest of the voltage occurs during the initial current rise where di/dt is large, with a resistance detectable by a finite voltage at the time di/dt is zero — that is, at the crest of the current, not counting the capacitance. Thus, one might define the impedance to the surge of this 75 m line as being 1700 V/400 A for a 25/70 μ s wave, or 4.25 'ohms', a far cry from the 100 Ω characteristic impedance determined by the first measurement reported in this paper. This impedance is essentially proportional to the line length, in contrast to the constant value of the characteristic impedance.

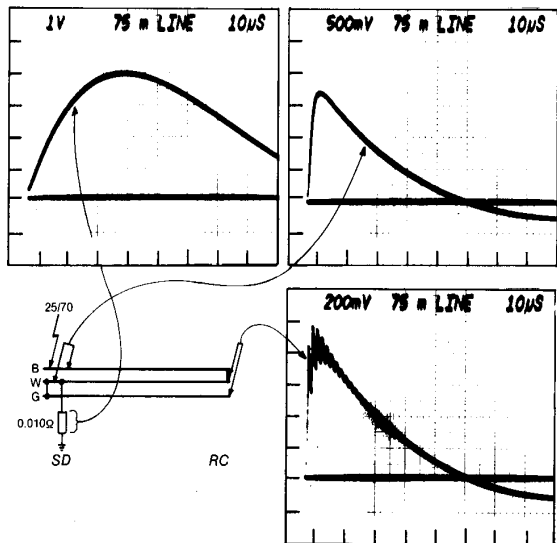

Figure 13. Current and voltage in 75 m line, unidirectional impulse

The complex nature of the line configuration is also evident in the voltage observed between the shorting jumper at the receiving end of the line and the green ground wire: the voltage is not just half of the sending voltage but, rather, the superposition of that half-voltage and higher frequency components which are not seen in the sending-end voltage.

Likewise, Figure 14 shows a first current crest of 48 A in the shorted 75 m line with a sending-end voltage of 5000 V when the 0.5 μs – 100 kHz generator is driving the line. This corresponds to an impedance to the surge of 100 ‘ohms’, not very different from the characteristic impedance. For the second crest, however, the current crest is 30 A with a voltage crest of 1300 V, or about 45 ‘ohms’ for the significant frequency of the second crest.

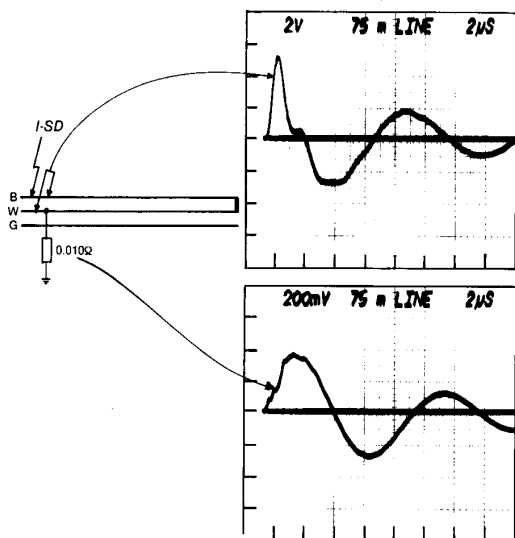

Figure 14. Current and voltage in 75 m line, oscillatory wave

The addition of the grounding wire (Figure 15) to the circuit of Figure 14 does not considerably change the crests of voltage and current but introduces the added complexity of a secondary oscillation superimposed on the driving oscillation.

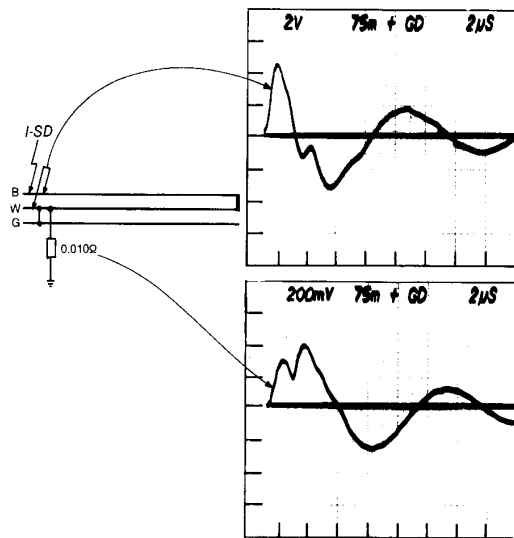

Figure 15. Effect of added grounding wire for 75 m line, oscillatory wave

Figure 16, similar to Figure 13, shows the propagation of a current surge in conduit-enclosed lines. For the same generator short-circuit wave form of 8/20 μs, the resultant current and voltages are shown for a 25 m conduit run. The ratio of voltage/current yields a value of 1500 V/850 A for the 20/50 μs current wave form, or an impedance of 1.8 ‘ohms’.

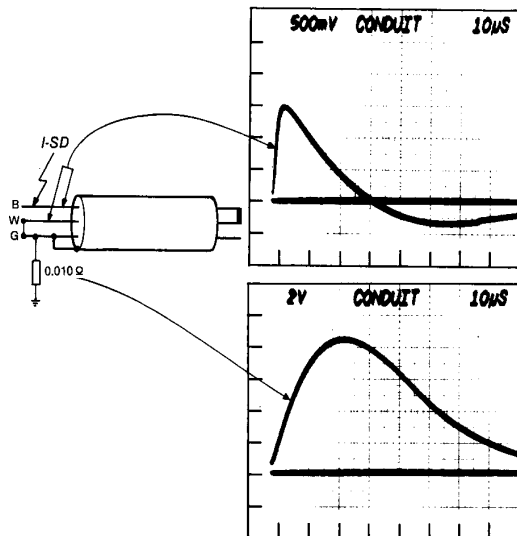

Figure 16. Current and voltage in 25 m conduit run, unidirectional impulse

Figure 17 shows the impedance of the 75 m line as a function of frequency, as measured by an impedance vector meter. The values of impedance defined as approximations for impulses are also shown on this graph.

Therefore, as a first approximation, a more useful view of the relative impedance values in a wiring system can be derived from this concept of “impedance to the surge” than from the use of characteristic impedance, provided that the user of this approximate concept does not lose sight of the approximations implied in the concept.

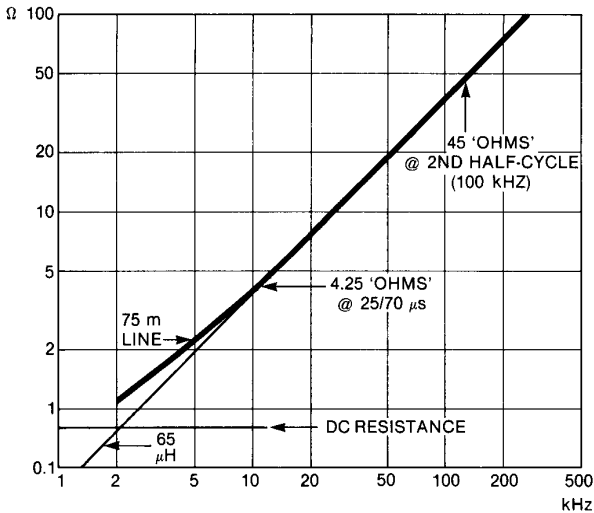

Figure 17. Impedance versus frequency of 75 m line

For instance, consider the case of a wiring system where a decreasing "staircase" of voltage surges is expected as the wiring progresses within the building, starting from the service entrance. Such a staircase is described in the IEC recommendations on Insulation Coordination [2]. The staircase is obtained by using the interface effect of the series and shunt impedances of the wiring, including line impedance, transformer (if any) series impedance, and shunt impedance of connected loads. While the series impedances are likely to be constant for a given system, the shunt impedances will vary with the loads. Alternatively, the decreasing voltages can be the result of installing surge protective devices at interfaces between sections of the wiring where the voltage decrease is to take place. Such a coordinated wiring system will require careful consideration of the line impedances for the various ranges of surge-effective frequency to be expected, so that proper coordination can be ensured between the successive protective devices installed at the interfaces [8].

The pitfalls of unsanitary wave forms

While an impulse generator is essentially an energy storage element (capacitor, line or inductance) discharged into the test specimen through some wave-shaping network, producing a clean wave shape as described in standards specifications is not a trivial undertaking. Unless precautions are observed, the stray inductance of capacitors or the stray capacitance of inductors as well as the wiring impedances can introduce unwanted oscillations — an "unsanitary" wave form.

Figure 18 gives an example of the problems that an unsanitary wave form can introduce. An attempt was made to apply a laboratory surge generator (built for energy deposition testing) to force a $8/20 \mu\text{s}$ current into the 75 m line, since the $8/20 \mu\text{s}$ short-circuit wave becomes stretched as discussed previously. The reasonably clean current wave form of Figure 18(A) would be quite acceptable as a test wave where total current, crest current, or energy are

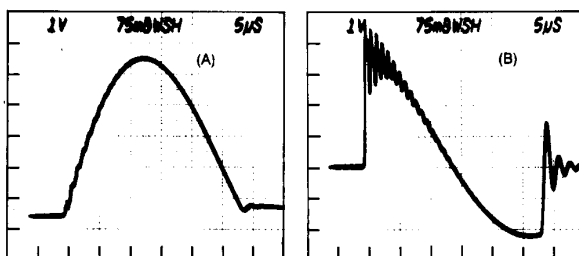

Figure 18. Effect of unsanitary current wave on line voltage

the significant parameter. However, when applied for the purpose of evaluating line impedance by measuring and computing V/I , the small ripple occurring on the current rise produces the $L(di/dt)$ oscillations seen in Figure 18(B). Thus, such an unsanitary wave form is totally useless for that purpose.

The effect on residual surges of connections options for suppressors

A noticeable lack of agreement has been observed among various application information sources on the most effective transient suppression configuration to be applied. Taking, as an example, the task of specifying the protection of an appliance or equipment connected at the end of a line with no opportunity to divert the transient closer to the source (for instance, at the service entrance), the options would be to connect one, two, or three surge suppressors between the three wires (black, white, and green) at the end of the line. However, more needs to be known: Will the impinging surge be in the normal mode (black to white) or in the common mode ([black-and-white]-to-green)? Where in the equipment is the most sensitive component: line-to-line (most likely) or line (black OR white)-to-green? Clearly, the situation is confusing, and there will not be a single, simple answer applicable indiscriminately to all cases. The National Electrical Code [9] specifically allows the connection of *surge arresters* (Article 280-22) if the interconnection occurs only by operation of the surge arrester during the surge. Since the standby current of a varistor or the leakage current of an avalanche diode suppressor is very low, the intent of this requirement can be met. Furthermore, there will not be any interference with the operation of Ground Fault Circuit Interrupters if the total number of suppressors does not result in a large current.

The set of measurements recorded in Figure 19 shows an example of these many options with increasing protection, albeit at increasing cost, from a single suppressor to three suppressors. The selection would depend on the vulnerability level and location of the equipment to be protected. The impinging surge is assumed to be black-to-[white and green], since white and green are tied together at the service entrance. The line is the 75 m line previously investigated, and the surge is that available from the generator set for a $2000 \text{ A } 8/20 \mu\text{s}$ short-circuit impulse. Rather than attempt to modify the setting of the generator for each case in order to maintain constant current crest for the various configurations (an impossible task if wave form is also to be maintained), the generator was left unchanged, to discharge a constant total energy in the system — not a bad hypothesis for the real world. This test was performed with 20 mm diameter varistors rated for 130 V rms line voltage, as an example. Similar results would be obtained with other types of clamping suppressors. The point is not so much the clamping voltage measured, as it is the relative differences for the various options shown. The current crests are all in the range of 300 to 380 A, which is not a significant change for comparing clamping voltages.

If only one suppressor is allocated to protect the equipment, the black-to-white suppressor connection affords maximum protection for the electronics which are also likely to be connected black-to-white. However, the voltages between either black or white and green are large; this is the stress that will be applied to the clearances of the equipment. This example shows a current surge, which might seem relevant only to surge suppressor applications, becomes a voltage surge issue, which is relevant to insulation coordination of clearances.

The configuration with suppressor black-to-green does not afford very good protection for components connected black-to-white; therefore, it should be used only if there is a special need to clamp black-to-green at a low voltage.

An improved protection is obtained with a suppressor black-to-white complemented by a second suppressor white-to-green. Another option, not investigated here but often used in applications of three-electrode gas tubes, would be the connection two

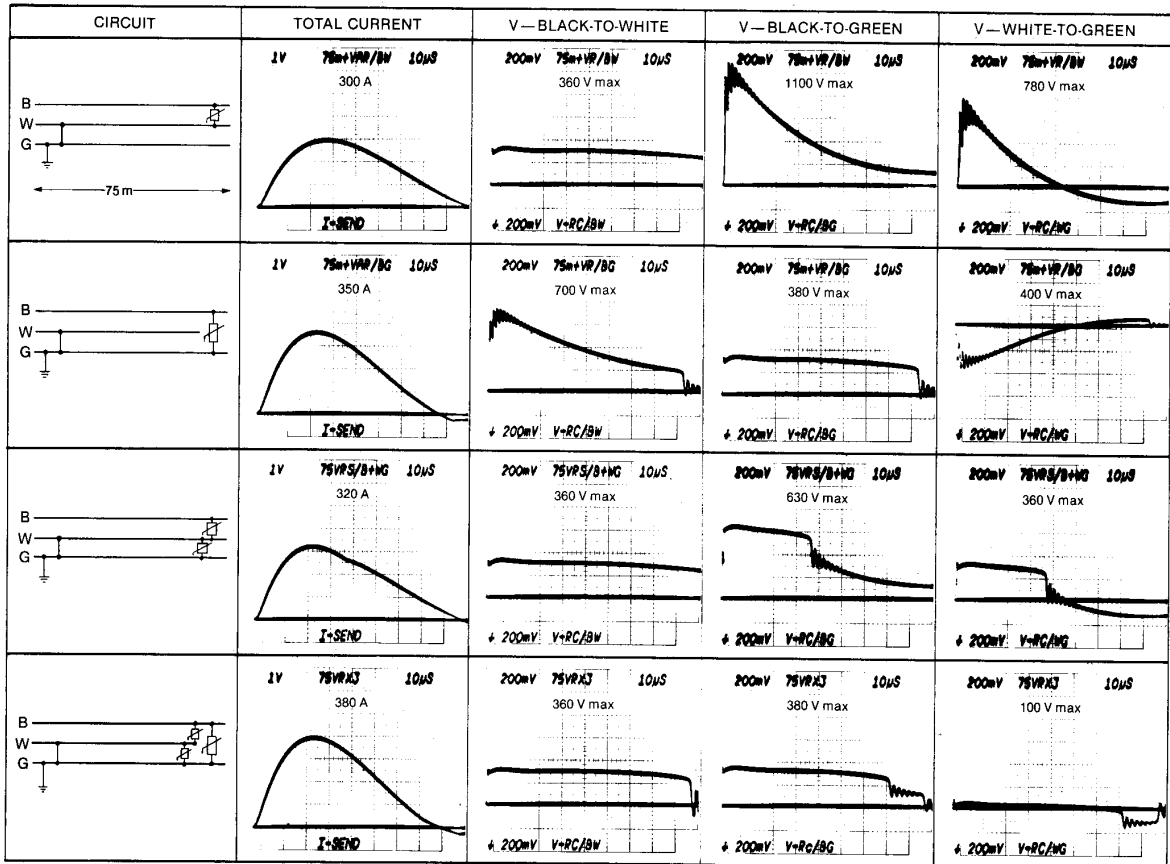

Figure 19. The effect on residual voltage surges of connections options for one, two, or three suppressors

suppressors, one between a line and the grounding conductor, the other between the second line and the grounding conductor. The ultimate protection is, of course, one suppressor in every position, but this should be required only for exceptionally sensitive loads.

CONCLUSIONS

The examples of surge propagation described provide the basis for several practical conclusions that should provide guidance in designing or evaluating surge protection schemes.

1. Surge propagation in wiring systems should be considered as a case of classical transmission lines only if the lines are long enough to contain the surge front.
2. For typical voltage or current surges produced by lightning or switching, the surge impedance (characteristic impedance) is not the significant parameter. Rigorous analysis requires considering the frequency spectrum of the impulse and the line impedance at the significant frequencies of that spectrum. Approximations can be made for specific current surge wave forms.
3. Isolating power transformers are intended to serve as ground isolators, or ground-loop breaks. They do not provide appreciable attenuation of line-to-line transients unless they are operating with their series reactance combined with a well-defined shunt load on the secondary.
4. Ferro-resonant line conditioners can provide attenuation of fast line-to-line transients with ratios of 100:1 or higher. Adding a small fixed load on the output side can raise this attenuation to 150:1, or more.

5. The connection options for surge suppressors must be matched to the protection requirements for optimum protection at minimum cost. Universally applicable solutions always tend to be more expensive.
6. Careful design is required for impulse generators. Improvisation can lead to meaningless results and wasted time.
7. In testing for surge protection evaluation, the timing of the surge with respect to the power line frequency can be significant.
8. The pure and sanitary test waves specified by test standards are intended to obtain reproducible results rather than to duplicate surges occurring in reality. Complex wiring system (within a building or within equipment) will promptly transform the pure wave form into a distorted form, but that does not prevent consistent results, since an agreement exists on the initial test wave.

ACKNOWLEDGMENTS

Discussion of surge protection techniques among members of the IEEE Working Group on Surge Characterization (for instance, the effect of connection options) has provided valuable insights into the problems and has motivated the examples presented in this paper. The contributions made by reviewers of the paper provided further insight on the subject and are gratefully acknowledged.

REFERENCES

1. IEEE Std 587-1980, "IEEE Guide for Surge Voltages in Low-Voltage AC Power Circuits," The Institute of Electrical and Electronics Engineers, Inc., New York.
2. IEC Publication 664, "Insulation co-ordination within low-voltage systems including clearances and creepage distances for equipment," International Electrotechnical Commission, Geneva, Switzerland, 1980. (Available in the United States from ANSI.)
3. IEEE Std 465.1-1977, "IEEE Standard Test Specifications for Gas Tube Surge Protective Devices," The Institute of Electrical and Electronics Engineers, Inc., New York.
4. IEEE Std C62.32-1981, "IEEE Standard Test Specifications for Low-Voltage Air Gap Surge-Protective Devices," The Institute of Electrical and Electronics Engineers, Inc., New York.
5. IEEE Std C62.33-1982, "IEEE Standard Test Specifications for Varistor Surge-Protective Devices," The Institute of Electrical and Electronics Engineers, Inc., New York.
6. F.A. Fisher and F.D. Martzloff, "Transient Control Levels," *IEEE Transactions on Power Apparatus and Systems* 95 (1), January/February, 1976.
7. F.D. Martzloff and F.A. Fisher, "Transient Control Level Philosophy and Implementation," paper presented at the 2nd EMC Symposium on Electromagnetic Compatibility, Montreux, June 28-30, 1977.
8. F.D. Martzloff "Coordination of Surge Protectors in Low-Voltage AC Power Circuits," *IEEE Transactions on Power Apparatus and Systems* 99 (1), January/February, 1980.
9. *National Electrical Code 1981*, National Fire Protection Association, Boston, Massachusetts.

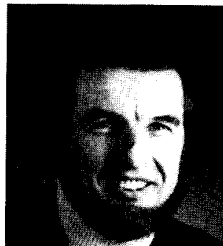

François D. Martzloff (M'56) was born in France, and received his undergraduate degree at the Ecole Spéciale De Mécanique et D'Electricité in 1951; he received the MSEE degree from Georgia Tech in 1952 and the MSIA degree from Union College in 1971.

Since 1956 he has been with the General Electric Company, where he gained experience in the Transformer and Switchgear Divisions. Upon joining General Electric Corporate Research and Development in 1961, he became involved in power semiconductor circuits and overvoltage protection. He has participated in the introduction and application of metal oxide varistors since 1971.

In IEEE, Mr. Martzloff is active on the Surge Protective Devices Committee. He is chairman of the Working Group on Surge Characterization in Low-Voltage Circuits. He is also a member of the Ad Hoc Advisory Subcommittee of the USA Advisory Committee on IEC S/C 28A and ANSI C.62 Subcommittee on Low-Voltage Surge Protective Devices. He has been awarded 10 U.S. patents, primarily in the field of varistors and transient protection.

Discussion

A. C. Liew (National University of Singapore, Kent Ridge, Singapore): The author has once again presented us with an interesting and practically useful paper.

Regarding the application of classical transmission line concepts to wiring systems and the concept of surge impedance, it is well known that surge impedance or characteristic impedance is applicable directly only until the time of arrival of the first reflection. After that, a lumped equivalent circuit is usually used or great effort in keeping track of the reflected and transmitted waves must be taken. This is evident in figure 14 of the paper.

The author's comments of the following observation made by us are appreciated.

We have found that for nearby lightning strokes, the induced voltages on the wiring system of a building (even when supplied by an underground cable at the service entrance) does not have to be very large to cause operation of sensitive Ground Fault Circuit Interrupters or Earth Leakage Circuit Breakers (current-operated type). Even with the installation of low voltage lightning arresters (500 V or 380 V type for a 415 V system) before the Ground Fault Circuit Interrupter, sufficient unbalance surge currents to ground can flow to cause its operation. This was traced to the distributed capacitances to ground of the wiring system. With the liberal connection of suppressers to the input terminals of sensitive equipment, the situation is likely to be further aggravated. Thus, while no damage occurs as with successful surge suppression, this nuisance tripping may be intolerable in certain cases.

Manuscript received August 9, 1982.

F. D. Martzloff: Indeed, as pointed out by Liew and myself, there are limitations to the application of classical transmission line concepts to wiring systems. However, while Liew states that these are well known, my experience in discussing the topic has shown me that in many instances, in the heat of a discussion, or under the pressure of a post-mortem, some erroneous or misapplied concepts can surface.

To avoid these situations, some repetition of known facts, presented with concrete examples, may be helpful and provide useful guidance. Thus, the purpose of the paper is not to report discoveries, but to make better known the limitations and pitfalls cited in the paper, in the context of concerns on surge propagation and attenuation.

E. K. Howell: While Liew reports operation of Ground Fault Circuit Interrupters coincident with nearby lightning strokes and attributes this operation to surge currents resulting from distributed capacitance of the wiring system, the information provided is not sufficient to warrant any specific conclusions, explanations, or recommendations.

Most Ground Fault Circuit Interrupters (GFCI) today use electronic signal processing and provide limiting and integration of the fault current signal, which tends to prevent operation by the fast surge currents. However, a flash-over in the wiring system may initiate a sub-cycle follow-through current, at power system frequency, having sufficient magnitude and duration to require operation of the interrupter. Furthermore, spark-gap types of low voltage lightning arresters have, inherently, a follow-through current which is limited by a varistor but may be large enough to properly cause GFCI operation if that current is allowed to pass through the ground fault current sensor.

There is also the possibility that the electronic circuit was susceptible to the surge voltage, rather than the current, as the result of insulation breakdown or some parasitic high-frequency coupling within the GFCI device. The present Underwriters Laboratory GFCI Standard No. 943 requires immunity (no tripping) to 3 kV crest of the 0.5 μ s-100 kHz voltage surge waveform. No current surge response requirement exists today. If tripping in response to a surge of voltage or current is sufficiently intolerable, then specifications defining acceptable performance should be considered, for either general use or special-purpose devices.

We both thank Professor Liew for the opportunity to clarify this subject.

Manuscript received October 12, 1982.