

# PYROGEN FIRE SUPPRESSION GRENADES

J. Berezovsky and S. Joukov  
AES International Pty Ltd  
Hurstville, NSW 2220, AUSTRALIA

## INTRODUCTION

The PyroGen Grenade is a hand-operated, thrown-in fire suppression device—a new form of already known PyroGen Fire Extinguishing Aerosol System [1-4]. The PyroGen Grenade has been designed as a first aid or emergency fire protection means in situations where fire has already developed and access to the site is either impeded or presents a serious hazard. Grenades would effectively suppress the fire and, therefore, allow access to the site and application of other extinguishing agent available to ensure complete extinguishment. For some standard applications, where the volume of the risk under protection is known and conditions for use of PyroGen Grenades are favorable. These grenades would not just suppress, but fully extinguish the fire, thus eliminating the necessity for other extinguishing means.

## CONSTRUCTION

The PyroGen Grenade implies the same extinguishing principle and construction as PyroGen Fixed Systems used in total-flooding applications. It is a self-contained non-pressurized canister consisting of the four main elements:

- a solid aerosol-generating element
- a solid cooling element
- a mechanical ignition device
- a discharge outlet(s)

In PyroGen Fixed Systems the ignition is either electrical (automatic or manual) or thermal (automatic). In PyroGen Grenades, the ignition device is mechanical (pull-ring) and is similar in construction and operation to the ignition device in a conventional military grenade. A schematic of the ignition device and its main elements in the PyroGen Grenade is shown in Figure 1.

Upon activation of the ignition device, the solid aerosol-generating element undergoes a combustion reaction to produce a micron-sized dry chemical powder (mainly, potassium carbonates) and inert gases (mainly, nitrogen, carbon dioxide, and water vapor) that mix together in a gas-like three-dimensional aerosol representing the actual extinguishing medium. The aerosol propels itself through the solid cooling element, which undergoes an endothermal decomposition reaction absorbing about 400 Cal of heat/1 kg of the cooling substance at a fantastic rate of 400 deg/sec. Cooled aerosol propels itself further down out of the discharge outlet into a protected enclosure.

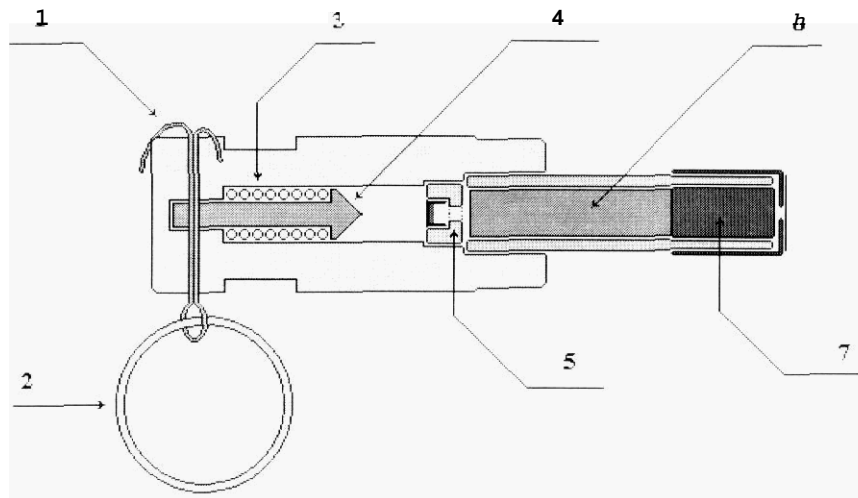

Figure 1. A schematic of the ignition device.

- |                 |                            |
|-----------------|----------------------------|
| 1 - a split pin | 5 - a capsule cartridge    |
| 2 - a ring      | 6 - a delay tube cartridge |
| 3 - a spring    | 7 - a booster              |
| 4 - a striker   |                            |

When the ring (2) is pulled out by straightening the ends of the split pin (1) the spring (3) looses the striker (4), which hits the capsule cartridge (5). The capsule cartridge ignites and propagates ignition down to the booster (7). The propagation is effected via the delay tube cartridge (6), thus ensuring a required delay of 6-10 sec (depending on the size of the grenade), between the activation of PyroGen Grenade and the discharge of the aerosol. Ignition of the booster causes ignition of the aerosol element resulting in release of the extinguishing aerosol.

## EXTINGUISHING ACTION

PyroGen aerosol is an exceptional fire suppressant, Primarily, the PyroGen extinguishing action is achieved by interfering chemically with the fire reaction. Two chemical mechanisms are emphasized below.

### 1. Removal of flame propagation radicals—"chain carriers" OH, H, and O in the flame zone

The main component of PyroGen aerosol (potassium carbonates) is in the gaseous form. In the flame zone they dissociate producing potassium radicals **K**. Potassium radicals are very active, react with "chain carriers" OH, H, and O, which they remove from the fire zone, thus disrupting the fire reaction.

The chemical action of potassium radicals in PyroGen is similar to that of bromine radicals in halons and can be schematically represented as follows:

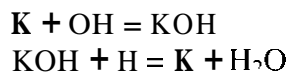

## 2. *Recombination of flame propagation radicals — "chaincarriers" OH, H, and O on aerosol particle surface*

Gaseous potassium carbonates condense to a liquid and then to a solid form, producing a large number of micron-size particles. Being so small, the particles produce a large surface area, where recombination of "chain carriers" takes place:

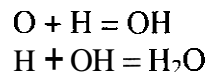

Secondarily, the PyroGen extinguishing action is achieved by lowering the fire temperature to a temperature below which the fire reaction cannot continue (thermal cooling). Several physical mechanisms can be noted, of which three are included below:

- (a) Heat absorption via endothermic phase changes:



- (b) Heat absorption via endothermic decomposition reaction:

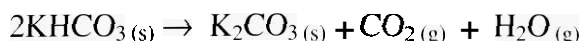

- (c) Dilution of the fire combustion zone by the aerosol cloud (additional fuel molecules cannot participate in the combustion process); physical hydrance to flame propagation (aerosol particles slow down velocity of a flame front propagation).

The extremely high surface area of the micron-size aerosol particles increases the likelihood of radical recombination and heat absorbing reactions, thus ensuring rapid extinguishment with a small amount of agent. PyroGen has the lowest extinguishing concentration known among commercially available agents: flammable liquids (class B fires) are extinguished at the design factor of 100 g/m<sup>3</sup> compared to 330 g/m<sup>3</sup> for Halon 1301. The high rate of aerosol discharge ensures a tremendous knockdown effect thus avoiding the conventional fire damage to assets. Micron-size aerosol particles exhibit gas-like three-dimensional qualities that allow the agent to distribute rapidly throughout the enclosure and reach the most concealed and shielded locations. Homogeneous distribution is achieved in a matter of seconds, while long holding times all help to prevent fire reignition. PyroGen aerosol is suitable for the protection of a variety of potential fire hazards, including those involving flammable liquids, combustible solids, oils, and energized electrical equipment. Like all total-flooding agents, PyroGen aerosol is most effective when used in an enclosed area.

### **PYROGEN ENVIRONMENTAL CHARACTERISTICS**

PyroGen does not affect earth's ozone layer, since it does not contain chlorine or bromine in its molecular structure. The contribution of PyroGen to global warming is negligible, since the only component (carbon dioxide) of PyroGen aerosol that could contribute to global warming is present in minor quantities at normal extinguishing concentrations. Both the ODP and GWP of PyroGen are zero.

## TEST SET-UP

### Objective

The following test was to demonstrate the ability of PyroGen Grenades to suppress fires that could occur within a small to medium-size enclosed room. The test was carried out on the test ground of Australian Defence (Melbourne, Victoria).

### Testing Chamber

The following enclosure was used for testing: 3.8 m long, 3.8 m wide, 2.2 m high with a total internal volume of 31.77 m<sup>3</sup>. Natural gaps and existing uncloseable openings were used to relieve excessive pressure build up during discharge and to ensure sufficient ventilation during preburn period.

### Model Fires

A tray (500 by 700 mm) with a diesel fuel and a jet fuel was centrally located on the floor to provide a **Class B** (flammable liquid) fire. Preburn time for diesel fuel was 2 min. Preburn time for jet fuel was 60 sec. The holding time for all fires was 3 min.

### Instrumentation

A number of K-type thermocouples were installed to measure fire temperature (extinguishment time) and ambient air temperature in the enclosure. Thermocouple outputs were recorded by means of a Data Logger connected to a computer to collect data at a rate of 10 times/sec and permit the subsequent print out of fire-out temperatures and enclosure temperature curves.

### PyroGen Grenades

The following grenades shown in Table 1 were used for testing.

### Design Calculations

The PyroGen design factor refers to the mass of nonignited, solid aerosol-generating element required to produce an adequate amount of aerosol to extinguish fire in 1 m<sup>3</sup> enclosure.

Design factor of 100 g/m<sup>3</sup> as established for class B fires was used for design calculations. **As** the internal volume was 31.77 m<sup>3</sup>, the total quantity was calculated as

$$100 \text{ g/m}^3 \times 31.77 \text{ m}^3 = 3,177 \text{ g.}$$

Seven PyroGen Grenades **MAG-SG** were recommended.

TABLE 1. PYROGEN GRENADES.

Parameters	Mag-5/1g (one discharge outlet)	Mag-5/2g (two discharge outlets)
Mass of grenade, g	2125	1870
Dimensions: diameter/length, mm	100/200	75/280
Mass of aerosol element, g	500	500
Delay time between activation and aerosol discharge, sec	8-10	8-10
Discharge time, sec	5-7	5-7
Maximum protected volume, m <sup>3</sup>	5	5
Operation temperature range	-50 °C + 50 °C	

### Test Procedure

The test procedure for all fire tests was as follows:

- First-aid portable fire extinguishers were at hand.
- Grenades were in operable condition. i.e., mechanical ignition devices were in place. The ends of the split pin were straightened, so that the grenades were ready to be thrown in one after another with minimum delay.
- Thermocouples were installed above the model fire and in the centre of the enclosure.
- A tray with fuel was centrally positioned on the floor. The door was left open during preburn period.
- The fuel was ignited. After preburn period, grenades were thrown in; it was advisable to throw all grenades in within a delay time period for the first grenade.
- The door was closed. Minimum 3 min holding time was allowed.
- The door was opened and the fire observed for extinguishment.

### Test Protocol

#### *Free-Burn Test*

A free-burn fire test (no agent) was conducted prior to the extinguishing test to demonstrate that sufficient oxygen and amount of fuel were provided and, therefore, extinguishment was due to the action of PyroGen grenades and not through fuel consumption or oxygen depletion.

#### *Jet Fuel Pan Fire Test— 7 MAG-5 Grenades*

Experimental temperature curves are given in Figure 2. On the Figure, the first start mark corresponds to the activation of the first Grenade, the second start mark to the activation of the last Grenade, and the third start mark to the closure of the door. As it can be seen from the fire temperature curve, within 7 sec from the closure of the door, the temperature of the fire started a sharp monotonous descent indicating fire extinguishment.

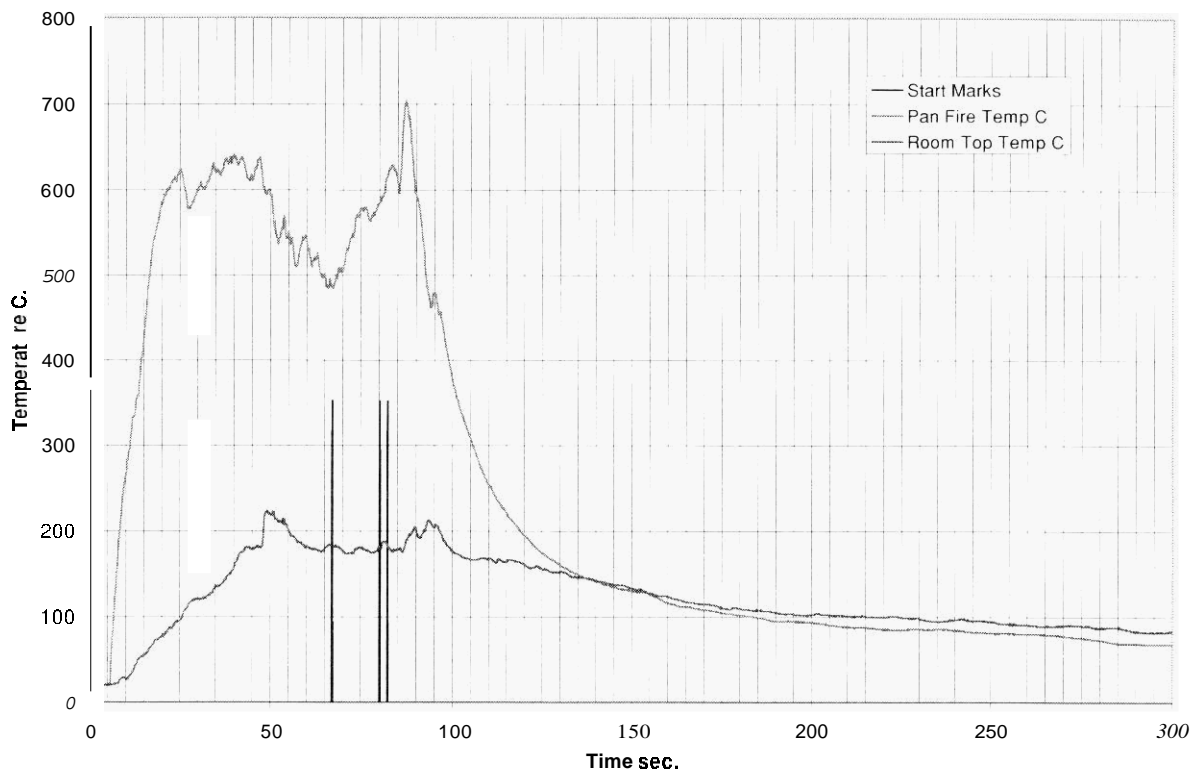

Figure 2. Jet fuel pan fire test—7 MAG-5 grenades

### ***Diesel Fuel Pan Fire Test—7 MAG-5 Grenades***

Experimental temperature curves are given in Figure 3. The first start mark corresponds to the activation of the first grenade, the second start mark to the activation of the last grenade, the third start mark (nearly overlapping the second start mark) to the closure of the door, and the fourth start mark to the opening of the door. As it can be seen from the fire temperature curve, within 8 sec from the closure of the door, the temperature of the fire started a sharp monotonous descent indicating fire extinguishment.

### ***Diesel Fuel Pan Fire Test – 4 MAG-5 Grenades***

The above test was repeated with only 4 MAG-5 generators, while 7 MAG-5 generators are required in accordance with design calculations for the extinguishment of the fire. The test was designed to demonstrate the ability of PyroGen Grenades to suppress the fire with a subsequent extinguishment by other means. Experimental temperature curves are given in Figure 4. The first start mark corresponds to the activation of the first grenade, the second start mark to the activation of the last grenade, and the third start mark to the closure of the door.

**As** can be seen from the fire temperature curve, within 8 sec from the closure of the door, the temperature of the fire started a sharp monotonous descent indicating fire extinguishment. Thus, with just 4 MAG-5 Grenades, which is 4/7 of the design quantity, the fire was fully extinguished, while only suppression of the fire was expected. No reignition occurred upon opening of the door after 3 min holding time.

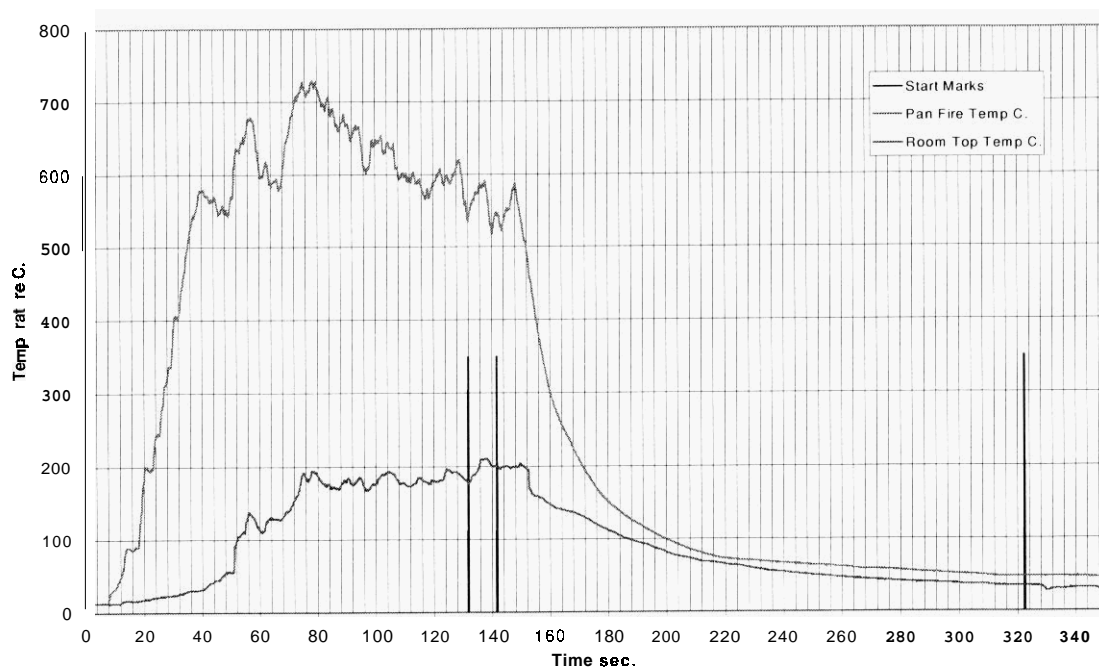

Figure 3. Diesel fuel pan fire test—7 MAG-5 grenades.

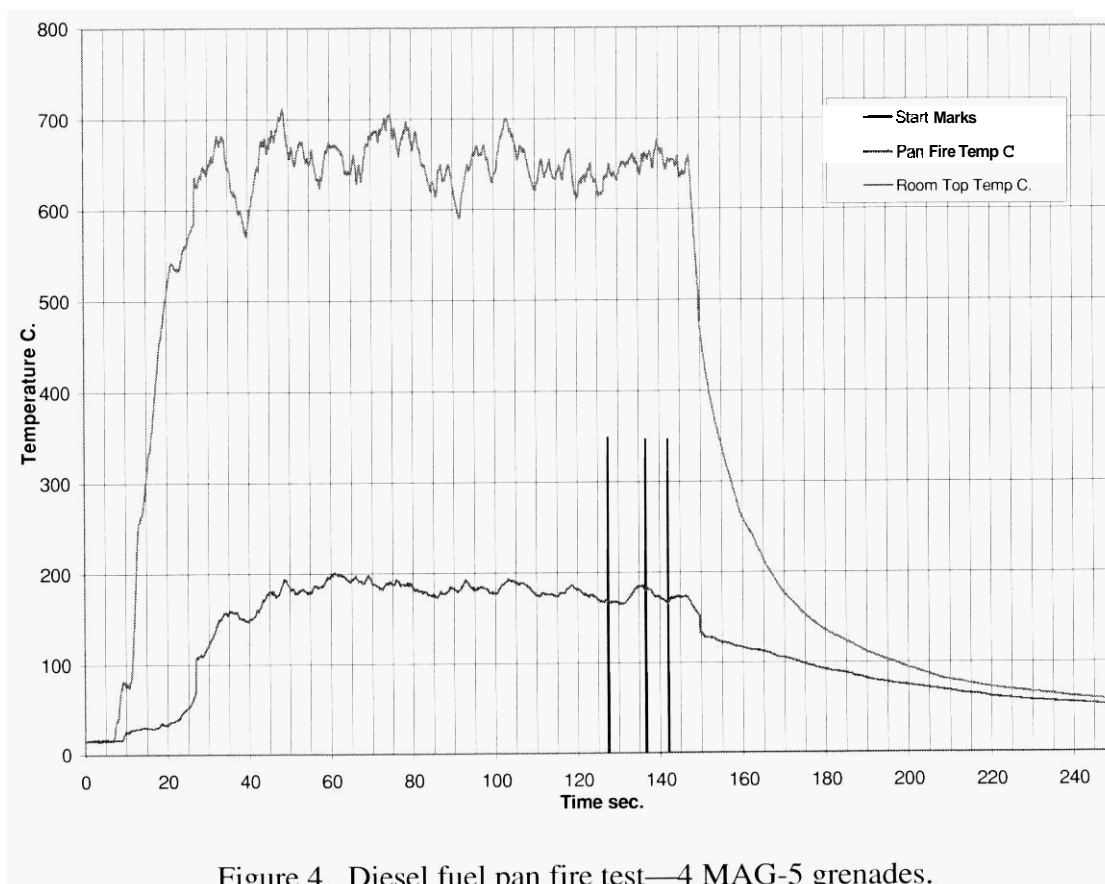

Figure 4. Diesel fuel pan fire test—4 MAG-5 grenades.

## TEST RESULTS

Table 2 summarizes the test results.

TABLE 2. SUMMARY OF TEST RESULTS.

Parameter	Design Quantity	Actual Quantity	Extinguishment	Remarks
Free-burn test	No agent	No agent	Fire not exting. within 4 min after door closure	Sufficient oxygen and fuel provided
Jet fuel pan fire test	7 MAG-5	7 MAG-5	Exting. within 7 sec after door closure	Significant loss of agent through gaps and uncloseable openings
Diesel fuel pan fire test	7 MAG-5	7 MAG-5	Exting. within 7 sec after door closure	Significant loss of agent through gaps and uncloseable openings
Diesel fuel pan fire test	7 MAG-5	4 MAG-5	Exting. within 8 sec after door closure	Exting. of fire was achieved with 4/7 of the design quantity

## CONCLUSION

PyroGen Grenades are thrown-in PyroGen canisters with a mechanical pull-ring type activation device. Designed as a first aid or emergency fire protection means in situations where fire **has** already developed and access to the site is either impeded or presents a serious hazards, PyroGen Grenades were tested for their suppression/extinguishing ability.

Under conditions of a significant loss of PyroGen aerosol through the natural gaps and uncloseable openings, PyroGen Grenades proved to be an effective extinguishing means with an instantaneous knock-down effect. With only 4/7 of the design quantity, PyroGen Grenades not just suppressed, but fully extinguished the diesel fuel pan fire, clearly indicating that the design methodology, including quantity calculations, limitations, and operation recommendation, provides a large safety margin and ensures reliable extinguishment of the typical Class B fires (flammable liquids) in a small to medium enclosure.

## REFERENCES

1. Berezovsky, J., "PyroGen: A New Chemical Alternative to Halons," *Proceedings*, Halon Options Technical Working Conference, Albuquerque, NM, pp. 396-403, 1997.
2. Berezovsky, J., "PyroGen Fire Suppression System – Marine & Vehicle Applications," *Fire Australia Jour-nul*. Aug. 1997.
3. Berezovsky, J., "PyroGen – A New Technology in Fire Protection," *Fire Engineers Journal*, pp. 24-26, July 1998.
4. Berezovsky, J., "PyroGen – A Revolution in Fire Suppression Technology?," *Fir-r Safety Engineering*, pp. 30-32, Oct. 1998