



Ohaus Corporation
29 Hanover Road
Florham Park, NJ
07932-0900

INSTRUCTION MANUAL



Explorer Balances

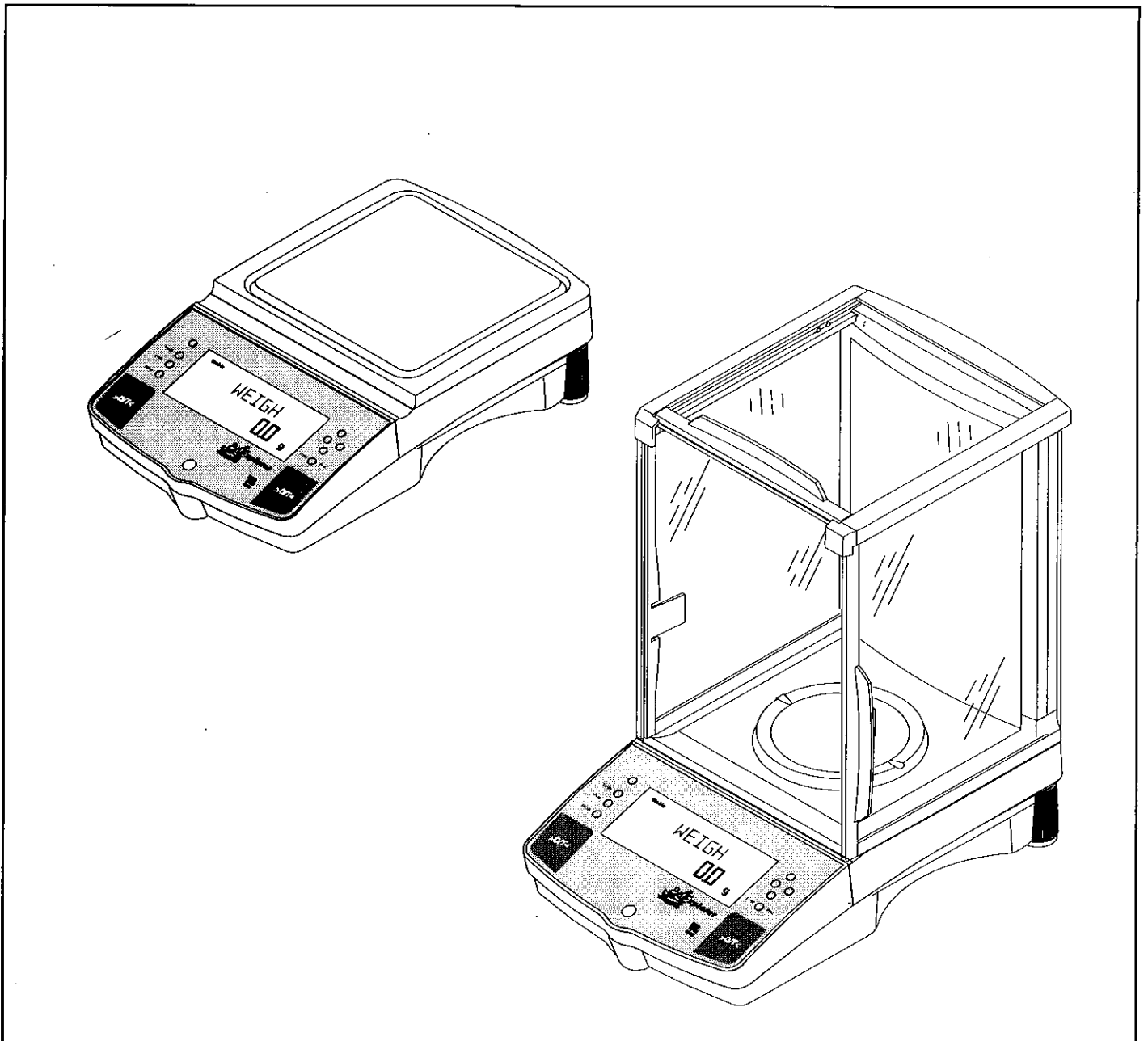

NOTE: THIS EQUIPMENT HAS BEEN TESTED AND FOUND TO COMPLY WITH THE LIMITS FOR A CLASS A DIGITAL DEVICE, PURSUANT TO PART 15 OF THE FCC RULES.

THESE LIMITS ARE DESIGNED TO PROVIDE REASONABLE PROTECTION AGAINST HARMFUL INTERFERENCE WHEN THE EQUIPMENT IS OPERATED IN A COMMERCIAL ENVIRONMENT. THIS EQUIPMENT GENERATES, USES, AND CAN RADIATE RADIO FREQUENCY ENERGY AND, IF NOT INSTALLED AND USED IN ACCORDANCE WITH THE INSTRUCTION MANUAL, MAY CAUSE HARMFUL INTERFERENCE TO RADIO COMMUNICATIONS. OPERATION OF THIS EQUIPMENT IN A RESIDENTIAL AREA IS LIKELY TO CAUSE HARMFUL INTERFERENCE IN WHICH CASE THE USER WILL BE REQUIRED TO CORRECT THE INTERFERENCE AT HIS OWN EXPENSE.

THIS DIGITAL APPARATUS DOES NOT EXCEED THE CLASS A LIMITS FOR RADIO NOISE EMISSIONS FROM DIGITAL APPARATUS AS SET OUT IN THE INTERFERENCE-CAUSING EQUIPMENT STANDARD ENTITLED "DIGITAL APPARATUS", ICES-003 OF THE DEPARTMENT OF COMMUNICATIONS.

CET APPAREIL NUMERIQUE RESPECTE LES LIMITES DE BRUITS RADIOELECTRIQUES APPLICABLES AUX APPAREILS NUMERIQUES DE CLASSE A PRESCRITES DANS LA NORME SUR LE MATERIEL BROUILLEUR : "APPAREILS NUMERIQUES", NMB-003 EDICTEE PAR LE MINISTRE DES COMMUNICATIONS.

Unauthorized changes or modifications to this equipment are not permitted.

Declaration of Conformity We, Ohaus Corporation, declare under our sole responsibility that the balance models listed below marked with "CE" - are in conformity with the directives and standards mentioned.



Konformitätserklärung Wir, die Ohaus Corporation, erklären in alleiniger Verantwortung, dass die untenstehenden Waagentypen, gekennzeichnet mit "CE" - mit den genannten Richtlinien und Normen übereinstimmen.

Déclaration de conformité Nous, Ohaus Corporation, déclarons sous notre seule responsabilité, que les types de balance ci-dessous cités - munis de la mention «CE» - sont conformes aux directives et aux normes mentionnées ci-après.

Declaración de Conformidad Nosotras, Ohaus Corporation, declaramos bajo responsabilidad exclusiva que los modelos de balanzas indicados a continuación - con el distintivo "CE" - están conformes con las directivas y normas citadas.

Dichiarazione di conformità Noi, Ohaus Corporation, U.S.A, dichiariamo sotto nostra unica responsabilità, che i tipi di bilance specificati di seguito - contrassegnati con la marcatura "CE" - sono conformi alle direttive e norme citate.

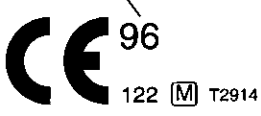
Balance Type/Waagentyp/Type de balance/Modelo de balanza/Tipo di bilancia **Explorer and Voyager**

| Marked with: gekennzeichnet mit: munis de la mention: con el distintivo: contrassegnati con la marcatura: | Directive Richtlinie Directive Directiva Direttiva | Standard Norm Norme Norma Norma |
|---|--|--|
| Year of attachment of the CE mark Jahr der ersten Eichung Année de la première vérification Año de la primera verificación annodella prima verifica  |  EU 73/23 Low Voltage EU 73/23 Niederspannung EU 73/23 Basse tension EU 73/23 Baja tensión EU 73/23 Bassa tensione <hr/> EU 89/336, 92/31, 93/68 Electromagnetic compatibility EU 89/336, 92/31, 93/68 elektromagnetische Verträglichkeit EU 89/336, 92/31, 93/68 Compatibilité électromagnétique EU 89/336, 92/31, 93/68 Compatibilidad electromagnética EU 89/336, 92/31, 93/68 Compatibilità elettromagnetica | IEC1010-1 & EN60950:1992 Safety Regulations IEC1010-1 & EN60950:1992 Sicherheitsbestimmungen IEC1010-1 & EN60950:1992 Consignes de sécurité IEC1010-1 & EN60950:1992 Disposiciones sobre seguridad IEC1010-1 & EN60950:1992 Prescrizioni di sicurezza <hr/> EN55022:1987 Emissions EN45501:1992, EN50082-1:1992 Immunity EN55022:1987 Funkstörungen EN45501:1992, EN50082-1:1992 Immunität EN55022:1987 Emissions parasites EN45501:1992, EN50082-1:1992 Immunité EN55022:1987 Radiointerferencias EN45501:1992, EN50082-1:1992 Inmunidad EN55022:Verträglichkeit 1987 Radiointerferenze EN45501:1992, EN50082-1:1992 Immunità |
| | EU 90/384 NAWI EU 90/384 FNSW EU 90/384 BFNA EU 90/384 PBNA EU 90.384 BFNA | EN45501:1992 Non Automatic Weighing Instruments EN45501:1992 für nicht selbsttätige Waagen EN45501:1992 balances à fonctionnement non automatique EN45501:1992 para balanzas no automáticas EN45501:1992 per bilance a funzionamento non automatic |

ISO 9001 Certificate for Ohaus Corporation. Ohaus Corporation, USA, was examined and evaluated in 1994 by the Bureau Veritas Quality International, BVQI, and was awarded the ISO 9001 certificate. This certifies that Ohaus Corporation, USA, has a quality system that conforms with the international standards for quality management and quality assurance (ISO 9000 series). Repeat audits are carried out by BVQI at intervals to check that the quality system is operated in the proper manner.

ISO 9001-Zertifikat für Ohaus Corporation. Die Firma Ohaus Corporation, USA, wurde 1994 durch das Bureau Veritas Quality International BVQI geprüft, und erhielt das ISO 9001 Zertifikat. Dieses bescheinigt, dass Ohaus Corporation, USA über ein Qualitätssystem verfügt, welches den internationalen Normen für Qualitätsmanagement und Qualitätssicherung (ISO 9000er-Reihe) entspricht. Anlässlich von Wiederhol-Audits durch das BVQI wird periodisch überprüft, ob das Qualitätssystem zweckmässig gehandhabt wird.

Certificat ISO 9000 pour Ohaus Corporation. La société Ohaus Corporation, USA, a été contrôlée en 1994 par Bureau Veritas Quality International BVQI et a obtenu le certificat, degré ISO 9001. Celui-ci atteste que Ohaus Corporation, USA, dispose d'un système qualité correspondant aux normes internationales pour la gestion de la qualité et pour l'assurance qualité (degré ISO 9000). Des audits réguliers effectués par la BVQI vérifient si le système qualité est appliqué de façon appropriée.

Certificado ISO 9001 para Ohaus Corporation. La firma Ohaus Corporation, USA, ha sido inspeccionada por la Bureau Veritas Quality International (BVQI) y ha obtenido el certificado ISO 9001. Esto acredita que Ohaus Corporation, USA, dispone de un sistema de calidad que cumple las normas internacionales para gestión y garantía de calidad (ISO serie 9000). Con ocasión de las inspecciones de repetibilidad por parte de la BVQI, se comprueba periódicamente si el sistema de calidad se manipula de forma correcta.

Certificato ISO 9001 per la Ohaus Corporation. Il sistema di garanzia della qualità della Società Ohaus Corporation, USA è certificato ISO 9001 sin dal 1994 dall Bureau Veritas Quality International BVQI, e così fornisce la dimostrazione che il suo sistema di Garanzia Qualità soddisfa i massimi requisiti. Il sistema della garanzia della qualità Ohaus Corporation viene verificato periodicamente dall BVQI, dando così evidenza di.

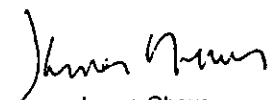
James Ohaus
President

John Enterline
Marketing Manager

Notice

Certified scales, scales used for legal applications have the general type designation E...5 / V...5 and EU type Approval (T2914). The year of the initial verification is shown next to the CE mark. Such scales are verified in the factory and carry the "M" mark on the actual scale and the packaging. The year of the initial verification is shown next to the CE mark. If the letter M is shown against a solid background, the scale may be put into operation immediately. Should the background be partitioned and hatched, the scale must be verified at its place of use by the certified Ohaus service. If national regulations limit the duration of the validity of the verification certificate in individual countries, the end user of such a scale is personally responsible for arranging the repeat verification in good time.

Hinweise

Geeichte/eichpflichtige Waagen tragen die allgemeine Typenbezeichnung E... 5 / V...5. Für sie liegt eine EU Bauartzulassung vor (T2914). Das Jahr der ersten Eichung ist neben dem CE Zeichen aufgeführt. Solche Waagen sind ab Werk geeicht und tragen die Kennzeichnung "M" auf dem Gerät selbst und auf der Verpackung. Erscheint der Buchstabe M auf vollem Grund, darf die Waage sofort in Betrieb genommen werden. Ist der Grund geteilt und schraffiert, muss die Waage am Verwendungsort durch den zertifizierten Ohaus Service ortsgerecht werden. Sofern gemäss den nationalen Vorschriften in den einzelnen Staaten die Gültigkeitsdauer der Eichung beschränkt ist, ist der Betreiber einer solchen Waage für die rechtzeitige Nacheichung selbst verantwortlich.

Remarques

Les balances vérifiées/admissibles à la vérification portent la désignation de modèle générale E...5 / V ... 5. Elles font l'objet d'une approbation de modèle UE (T2914). L'année de la vérification primitive est indiquée à côté de la marque CE. Ces balances sont vérifiées d'origine et portent la marque "M" sur l'appareil lui-même et sur l'emballage. Si la lettre M apparaît sur un fond totalement vert, la balance peut être mise en service immédiatement. Si le fond est divisé et hachuré, la balance doit être vérifiée sur le lieu d'utilisation par le service après-vente Ohaus certifié. Dans les pays où la durée de validité de la vérification est limitée par des prescriptions nationales, l'utilisateur est lui-même responsable de la vérification ultérieure d'une telle balance en temps voulu.

Notas

Las balanzas verificadas/verificables llevan la designación general E...5 / V ...5 y cuentan con una aprobación de modelo UE (T2914). EL año de la primera verificación está indicado al lado del distintivo CE. Estas balanzas están verificadas en fábrica y llevan la designación "M" sobre el propio aparato y sobre el embalaje. Cuando la letra M aparece sobre fondo sólido, la balanza se puede poner inmediatamente en funcionamiento. Si el fondo está dividido y rayado, la balanza ha de ser verificada en el lugar de uso por el servicio técnico Ohaus certificado. Si la duración de la validez de la verificación está limitada de acuerdo con las normas de los distintos países, el propio usuario de tal balanza es responsable de la verificación posterior a su debido tiempo.

Avvertenza

Le bilance approvate hanno la denominazione del modello E... 5 / V ...5. Per esse esiste un'approvazione CE del tipo. L'anno della prima verifica è indicato a fianco della marcatura CE. I tipi marcati con un contrassegno "M" su sfondo verde pieno possono essere impiegati da subito. I tipi marcati con il contrassegno "M" su sfondo nero/barrato diagonalmente dovranno essere verificati sul luogo d'installazione da parte d'un tecnico autorizzato dal Servizio Assistenza Ohaus o ispettore dell'Ufficio Metrico. Queste bilance sono state verificate in fabbrica e recano il contrassegno "M" sull'apparecchio stesso, e sull'imballo. È obbligo dell'utente denunciare la detenzione dello strumento all'ufficio metrico competente per territorio e sottoporlo alla prescritta verifica periodica come da disposizioni ministeriali.

TABLE OF CONTENTS

| | |
|---|----|
| OVERVIEW OF CONTROLS | 1 |
| OVERVIEW OF DISPLAY INDICATORS | 2 |
| 1. GETTING TO KNOW YOUR BALANCE | 3 |
| 1.1 Introduction | 3 |
| 2. INSTALLATION | 3 |
| 2.1 Unpacking and Checking the Standard Equipment | 3 |
| 2.2 Selecting the Location | 4 |
| 2.3 Setting Up and Leveling the Balance | 4 |
| 2.4 Installing Cover Plate and Pan | 5 |
| 2.5 Installing Wind Shield | 5 |
| 2.6 Connecting Power | 5 |
| 3. OPERATING YOUR BALANCE | 6 |
| 3.1 The Menu (Basic Settings of the Instrument) | 6 |
| 3.2 Turning On the Balance | 7 |
| 3.3 Calibration | 7 |
| 3.3.1 Internal Calibration (InCAL™) | 9 |
| 3.3.2 Span Calibration | 10 |
| 3.3.3 User Calibration | 11 |
| 3.3.4 Linearity Calibration | 12 |
| 3.3.5 Calibration Test | 13 |
| 3.3.6 Calibration GLP Printout | 14 |
| 3.4 Weighing | 15 |
| 3.5 Percent Weighing | 16 |
| 3.6 Parts Counting | 17 |
| 3.7 Animal Weighing | 18 |
| 3.18 Printing Data | 19 |
| 4. SETTING UP YOUR BALANCE | 21 |
| 4.1 Setting Date and Time | 21 |
| 4.2 Readout | 22 |
| 4.3 Good Laboratory Practices (GLP) Data | 22 |
| 4.4 Good Laboratory Practices (GLP) Set | 22 |

TABLE OF CONTENTS (Cont.)

| | | |
|------|--------------------------------|----|
| 4.5 | Print | 23 |
| 4.6 | RS232 | 25 |
| 4.7 | Legal for Trade (LFT) | 26 |
| 4.8 | Mode | 27 |
| 4.9 | Units | 28 |
| 4.10 | Global | 28 |
| 4.11 | Custom Unit | 30 |
| 4.12 | Menu Lock-Out Protection | 32 |
| 5. | CARE AND MAINTENANCE | 33 |
| 5.1 | Troubleshooting | 33 |
| 5.2 | RS232 Interface | 34 |
| 5.3 | Error Codes List | 37 |
| 5.4 | Information Messages | 37 |
| 5.5 | Service Information | 38 |
| 5.6 | Replacement Parts | 38 |
| 5.7 | Accessories | 38 |
| 5.8 | Specifications | 39 |

OVERVIEW OF CONTROLS

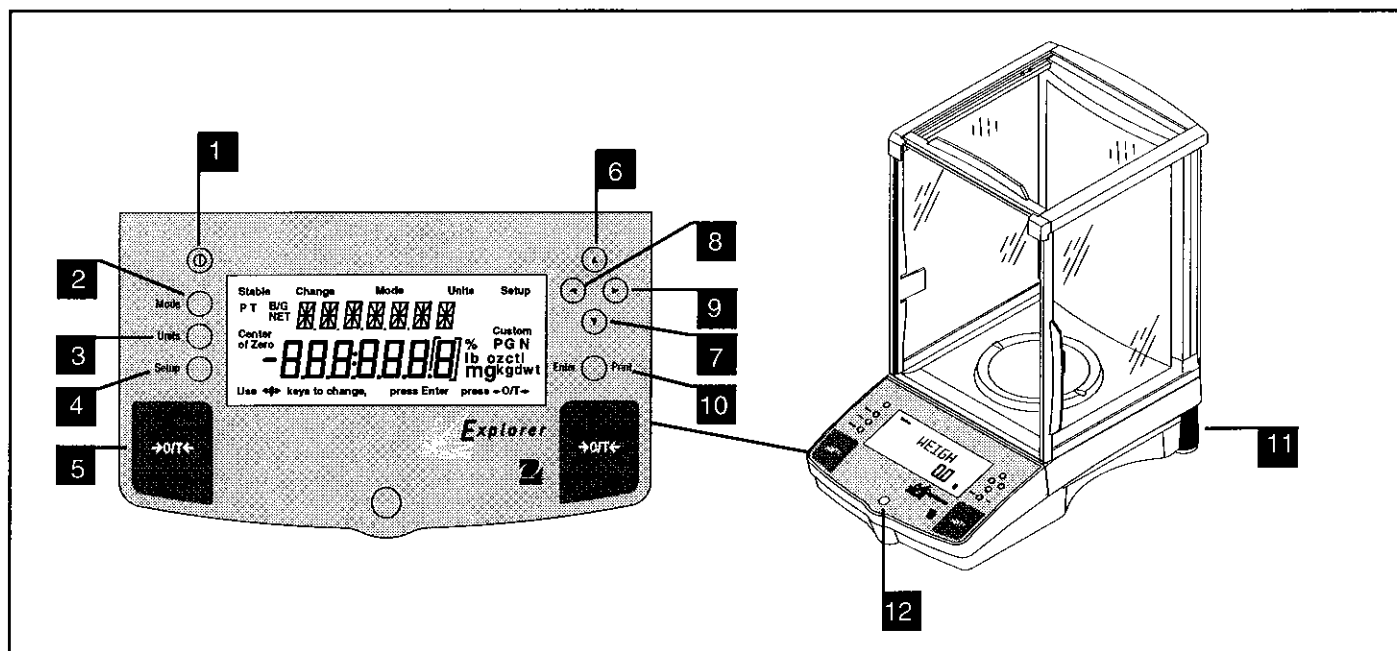

| No. | Designation | Function |
|-----|--------------------|--|
| 1 | Ⓚ | Power on off button. |
| 2 | Mode button | Selects standard weighing, percent, parts counting and animal weighing modes. |
| 3 | Units button | Selects weighing units. |
| 4 | Setup button | Selects various submenus: calibration, date, time, readout, GLP data, GLP set, print, RS232, LFT, function, units, global, custom. |
| 5 | →O/T← button | When pressed, sets balance to zero. |
| 6 | ▲ button | When pressed, travels up through submenus. |
| 7 | ▼ button | When pressed, travels down through submenus. |
| 8 | ◀ button | When pressed, travels to the left through menus. |
| 9 | ▶ button | When pressed, travels to the right through menus. |
| 10 | Enter/Print button | When in menus, selects item on display, otherwise prints data. |
| 11 | Leveling feet | Used to level the balance. |
| 12 | Leveling indicator | Indicates leveling position of the balance. |

OVERVIEW OF DISPLAY INDICATORS

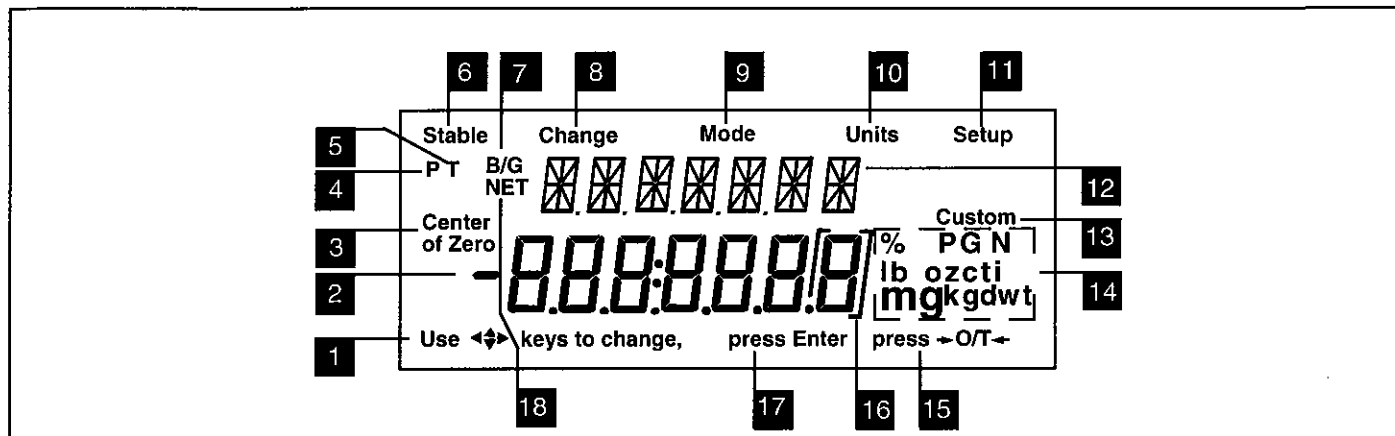

| No. | Function |
|-----|--|
| 1 | Use (Pointer Group) key to change - used to prompt the user while navigating through the menu system. |
| 2 | Standard (7) segment numeric characters. Seven characters are available and are used for displaying weight values. |
| 3 | Center of Zero - Indicates Center of Zero in Legal For Trade (LFT) mode. |
| 4 | P - This symbol is not used. |
| 5 | T - This symbol is not used. |
| 6 | Stable - Indicates that the measured value has become stable. |
| 7 | B/G - This symbol is not used. |
| 8 | Change - Is displayed together with Mode , Units or Setup signifying that a change to balance settings is being performed. |
| 9 | Mode - Is displayed when the Mode button is pressed. Allows the user to know what area of the balance menu is being addressed. |
| 10 | Units - Is displayed when the Units button is pressed. Allows the user to know what area of the balance menu is being addressed. |
| 11 | Setup - Is displayed when the Setup button is pressed. Allows the user to know what area of the balance menu is being addressed. |

| No. | Function |
|-----|--|
| 12 | (British Flag) - Are (14) segment alpha numeric characters. Seven characters are used to present features and functions. |
| 13 | Custom - The user can input a factor to meet unique unit measure applications. |
| 14 | Symbols for weighing modes, include: % - Percent weighing. PC - Parts counting. GN - Grain. N - Newtons. m - Mommies. mg - Milligrams. g - Grams. kg - Kilograms. dwt - Pennyweight. lb - Pounds. oz - Ounces. ct - Carats. t - Taels. Taels are available in three types; Hong Kong, Singapore, and Taiwan. ti - Tical. oz t - Ounces troy. |
| 15 | press →O/T← - This symbol is not used. |
| 16 | [] - Differentiated digit for LFT. |
| 17 | press Enter - Used as a prompt to the user to press the Enter button. The menu item displayed is accepted/selected. |
| 18 | NET - This symbol is not used. |

1. GETTING TO KNOW YOUR BALANCE

Please read through this section carefully, as it contains important information for safe and economical operation of your Explorer Balance.

1.1 Introduction

Thank you for deciding to purchase an Explorer Balance from Ohaus. Thanks to a new modular design, your Explorer Balance lets you adapt the balance to your changing needs. Remote displays, upgraded displays which can be table, wall or tower mounted are available as accessories. It offers a high level of operating convenience and useful functions to make accurate measurements. A unique LCD panel has a large 7 digit, 7 segment display which indicates the weight value of an item being measured and a 7 digit British Flag display (14 segments) which spells out items selected in the submenus. In addition, the display contains English words to indicate the status of the balance. Arrow indicators in the display prompt the user as to what panel keys are to be pressed to initiate a change. Panel controls are clearly marked as to their function with large Tare buttons on either side of the front panel. Operation and setup of the balance is straightforward and easy. The Explorer Balance is available in a variety of full scale capacities ranging from 62 grams to 8,100 grams with FineRange range models available. Legal for Trade versions are available.

Behind your instrument stands OHAUS, a leading manufacturer of precision scales and balances. An Aftermarket Department with trained instrument technicians is dedicated to provide you with the fastest service possible in the event your instrument requires servicing. OHAUS also has a Customer Service Department to answer any inquiries regarding applications and accessories.

To ensure you make full use of the possibilities offered by your Explorer balance, we advise you to read through these operating instructions very carefully.

2. INSTALLATION

2.1 Unpacking and Checking the Standard Equipment

Open the package and remove the instrument and the accessories. Check the completeness of the delivery. The following accessories are part of the standard equipment of your new Explorer balance.

| Equipment | Top Loader | | | |
|-------------------------------------|------------|--------------------|---------------------------------------|---------------------|
| | Analytical | 210, 410, 410/100g | 610g, 1550g, 2100g, 4100g, 4100/1000g | 6100g, 4100g, 8100g |
| • Pan 3.5 | ✓ | | | |
| • Pan 4.75" | | ✓ | | |
| • Pan 6" (0.01g units) | | | ✓ | |
| • Pan 8" (0.1g units) | | | | ✓ |
| • Draft Shield | ✓ | ✓ | | |
| • Wind Shield (6" Pan Units, 0.01g) | | | ✓ | |
| • AC Power Adapter | ✓ | ✓ | ✓ | ✓ |
| • Instruction Manual | ✓ | ✓ | ✓ | ✓ |
| • Warranty Card | ✓ | ✓ | ✓ | ✓ |

- Remove packing material from the instrument.
- Check the instrument for transport damage. Immediately inform your Ohaus dealer if you have complaints or parts are missing.
- Store all parts of the packaging. This packaging guarantees the best possible protection for the transport of your instrument.

2.2 Selecting the Location

The balance should always be used in an environment which is free from excessive air currents, corrosives, vibration, and temperature or humidity extremes. These factors will affect displayed weight readings.

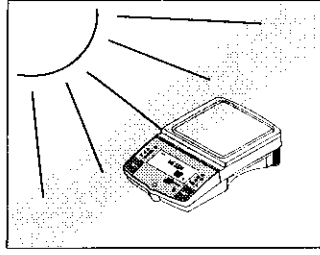
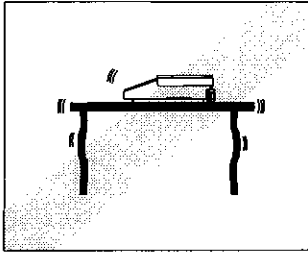

DO NOT install the balance:

- Next to open windows or doors causing drafts or rapid temperature changes.
- Near air conditioning or heat vents.
- Near vibrating, rotating or reciprocating equipment.
- Near magnetic fields or equipment that generates magnetic fields.
- On an unlevel work surface.
- Allow sufficient space around the instrument for ease of operation and keep away from radiating heat sources.

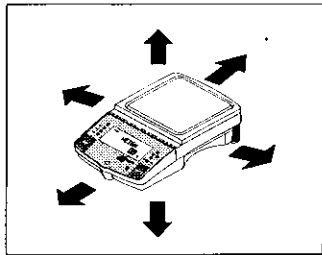
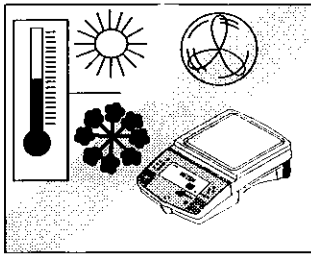

2.3 Setting Up and Leveling the Balance

Exact horizontal positioning and stable installation are prerequisites for repeatable results. To compensate small irregularities or inclinations at the location, the instrument can be leveled.

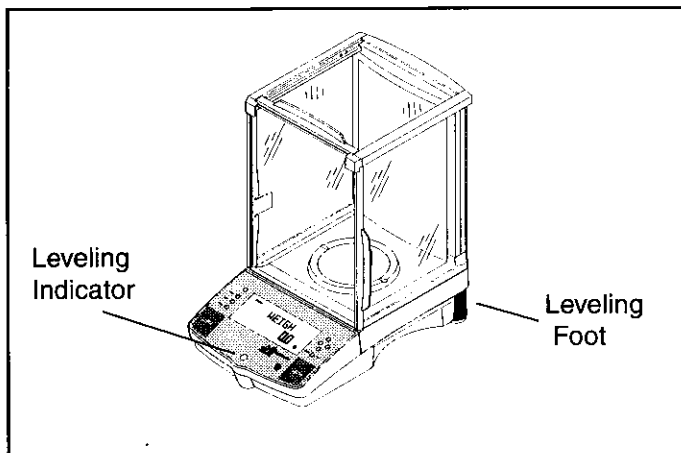

For exact horizontal positioning, the balance is equipped with a level indicator located at the front on the control panel and two leveling feet located at the rear of the balance.

Position the balance in the intended operating location. Adjust the leveling feet at the rear of the balance until the air bubble in the indicator is centered.

NOTE: The instrument should be leveled each time its location is changed.

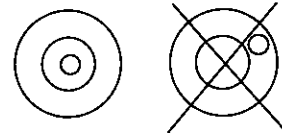

2.4 Installing Cover Plate and Pan

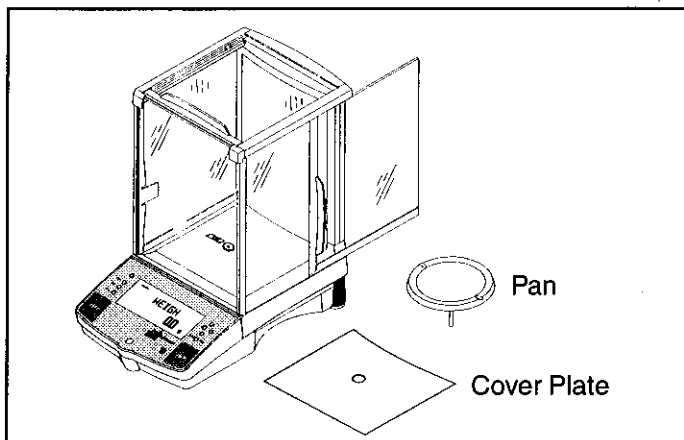

Balances in the range of 62g to 410g are shipped with the pan and the protective cover plate not installed. On balances equipped with a draft shield, slide open the side door and place the cover plate into position. Then, insert the pan into the center hole which is the measuring transducer. Higher capacity balances with 6" or 8" pans do not have a cover plate.

2.5 Installing Wind Shield

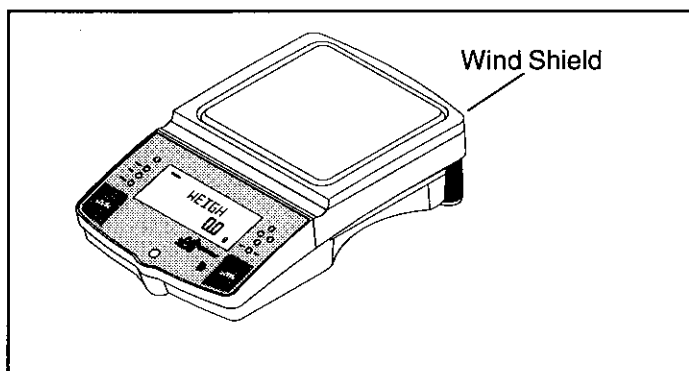

On 610g to 4100g balances with 0.01g resolution, a wind shield is required to reduce the possibility of air currents from disturbing the pan. When the wind shield is in place, air currents are deflected up over the pan. Make sure the wind shield is firmly snapped into place.

2.6 Connecting Power

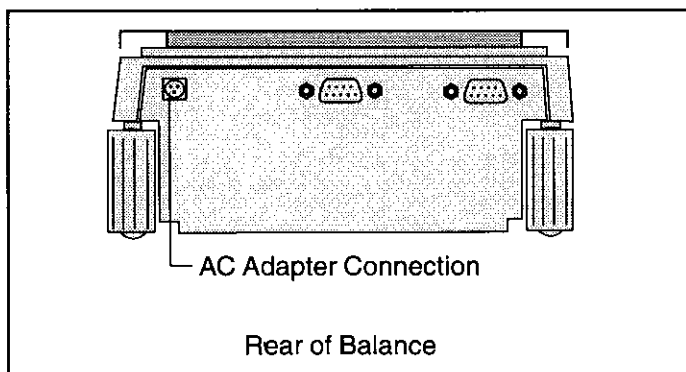

Connect the AC Adapter supplied to the three pin connector located at the rear of the balance.

The balance is now ready for operation.

3 OPERATING YOUR BALANCE

3.1 The Menu (Basic Settings of the Instrument)

The Explorer balance has three basic menus; each is selected by front panel buttons marked **Mode**, **Units** and **Setup**.

Mode Button

The Mode button, when pressed, permits the selection of four weighing modes which are: weigh, percent, count and animal weighing. These modes are controlled by an on or off selection made in the Setup menu under the submenu **Mode** as displayed.

Units Button

The Units button, when pressed, allows the balance to display values in selected measuring unit.

Setup Button

The Setup button, when pressed, allows entry into thirteen submenus which allows you to set the balance for specific operating parameters. Each of the thirteen submenus contain settings which are user selectable. The table below illustrates the various submenus and the functions which are selectable. The items shown on the menu, which are bolded, are the factory default settings. In other words, if you did not enter the Setup menu, the balance would function in the basic manner shown by the various settings which are bolded. The setup submenus shown below are arranged in the order as displayed in the balance.

START

| CALIBRATION | |
|-------------------------------|--------|
| InCAL™ Calibration (No Lock)* | |
| Span Calibration | |
| User Calibration | |
| Linearity Calibration | |
| Calibration Test (No Lock) | |
| Lock | ON/OFF |
| Exit | |

* (If option is installed.)

| READOUT | |
|---------|--------------------|
| Filter | -0-, -1-, -2-, -3- |
| Stable | .5d, 1d, 2d, 5d |
| Auto 0 | OFF, .5d, 1d, 5d |
| Lock | ON/OFF |
| Exit | |

| PRINT | |
|------------|--------------------------|
| Auto Print | OFF, Cont, Inter, On Stb |
| Interval | Enter 1 seconds |
| Stable | ON/OFF |
| Numeric | ON/OFF |
| GLP Cont | ON/OFF |
| GLP Tare | ON/OFF |
| Reference | ON/OFF |
| Lock | ON/OFF |
| Exit | |

| MODE | |
|---------|--------|
| Weigh | ON/OFF |
| Percent | ON/OFF |
| Count | ON/OFF |
| Animal | ON/OFF |
| Lock | ON/OFF |
| Exit | |

SETUP SUBMENUS

| DATE | |
|----------|-------|
| Type | m/d/y |
| Set Date | |
| Exit | |

| GLP DATA | |
|----------------|----------------|
| User Number | Enter 7 digits |
| Project Number | Enter 7 digits |
| Lock | ON/OFF |
| Exit | |

| RS232 | |
|--------|-------------------------------------|
| Baud | 300, 1200, 2400 , 4800, 9600 |
| Parity | None , -E-, -Odd-, -0-, -1- |
| Data | 7,8 |
| Stop | 1, 2 |
| Lock | ON/OFF |
| Exit | |

| UNITS | |
|-------|--------|
| Units | ON/OFF |
| Lock | ON/OFF |
| Exit | |

| TIME | |
|----------|-------------------------|
| Type | 12 Hour /24 Hour |
| Set Time | |
| Adjust | Enter xx seconds |
| Exit | |

| GLP SET | |
|----------------|--------|
| Time | ON/OFF |
| Balance ID | ON/OFF |
| User Number | ON/OFF |
| Project Number | ON/OFF |
| Difference | ON/OFF |
| Name | ON/OFF |
| Lock | ON/OFF |
| Exit | |

| LEGAL FOR TRADE | |
|-----------------------|--------|
| LFT LOCK | ON/OFF |
| (Locked using switch) | |

| GLOBAL | |
|---------|--------------|
| List | NO/YES |
| Reset | NO/YES |
| Version | Software No. |
| Lock | ON/OFF |

| CUSTOM | |
|----------|-----------------|
| Factor | Enter 7 digits |
| Exponent | Enter +3 to -3 |
| LSD | Enter .5 to 100 |
| Lock | ON/OFF |
| Exit | |

3.2 Turning On the Balance

The Explorer balance is ready to operate after the installation procedures are performed. When the balance is first turned on and it completes its checks, it can be used to weigh or tare materials without setting the menus.

It is recommended that you read this manual carefully and set the balance to operate for your specific applications using the procedures in Chapter 4 Setting up Your Balance and calibrate the balance before using.

The balance is a high precision instrument and will give you years of service if kept clean and handled carefully. If you have any problems operating the instrument or require additional information, please feel free to contact our Product Service Department at (800) 526-0659.

In this section, you will enter the menu for the first time. Do not worry if you are unfamiliar with the function of the buttons on the panel, the display provides the necessary coaching as you go along.

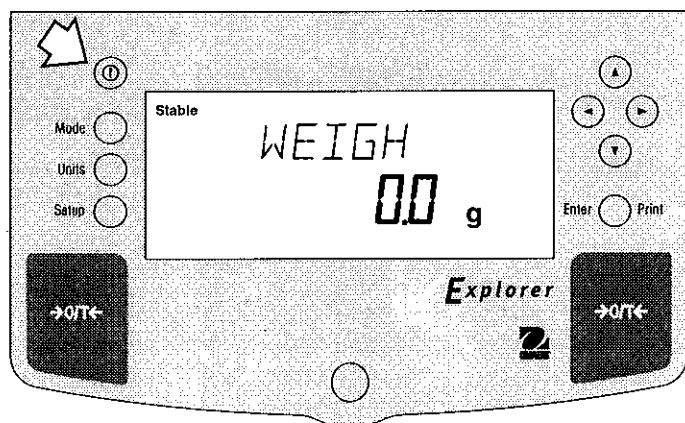

Power On/Off

To turn the balance ON, press the ON/OFF button (circled button with an I inside) located at the upper left-hand corner of the panel once. To turn OFF, press button again.

Stabilization

Before initially using the balance, allow time for it to adjust to its new environment. The balance only requires to be plugged in to warm up. Recommended warm up period is twenty (20) minutes. Analytical Class I balances require at least 2 hours. The internal circuits of the balance are powered whenever it is plugged into a power source.

Calibration

Refer to paragraph 3.3 and calibrate the balance before proceeding.

3.3 Calibration

Explorer balances offer a choice of five calibration methods: Internal Calibration (InCAL™), Span Calibration, User Calibration, Linearity Calibration, and CalTest™.

- **InCal™** Internal calibration (InCAL™) of the balance is accomplished by an internal mass. (If option is installed.)

NOTE: When CAL NOW is displayed, the balance should be calibrated before weighing again.
- **Span -** Span calibration ensures that the balance reads correctly within specifications using two weight values: zero and a weight value at incremental values of full capacity and or 100% of the balance's full capacity.
- **User -** User calibration is a method where the balance can be calibrated using a mass of known value and by entering that numeric value into the balance.
- **Linearity -** Linearity calibration minimizes deviation between actual and displayed weights within the balance's weighing range. Three weight values are used: zero, a weight value at midpoint of the balances weighing range, and a weight value at or near the balance's specified capacity.
- **Cal Test -** Calibration test allows the stored calibration data to be tested against the current mass being used for the test.
- **Lock -** Can be set on or off. When set on, Span, User and Linearity are locked out and cannot be used.

3.3 Calibration (Cont.)

Calibration Menu Protection

NOTES:

- Calibration may be locked out to prevent unauthorized personnel from changing calibration. If calibration has been locked out, you can only access Internal Calibration (InCAL™) when installed and Cal Test.
- To lock out calibration menu, after calibration, refer to the section titled Menu Lock-Out Protection.

Calibration Masses

Before beginning calibration, make sure masses are available. If you begin calibration and realize calibration masses are not available, exit the menu. The balance will retain previously stored calibration data. Calibration should be performed as necessary to ensure accurate weighing. Masses required to perform the procedures are listed in the adjacent table.

NOTE:

Any of the calibration modes can be terminated *at any time* by pressing either the **Mode**, **Units** or **Setup** buttons.

CALIBRATION MASSES

| CAPACITY | LINEARITY MASSES | SPAN ONLY MASSES |
|-----------------|-------------------------|-------------------------|
| 62g | 20g/50g | 50g |
| 162g | 50g/150g | 150g |
| 110g | 50g/100g | 100g |
| 210g | 100g/200g | 200g |
| 410g | 200g/400g | 400g |
| 610g | 200g/500g | 500g |
| 1550g | 500g/1500g | 1500g |
| 2100g | 1000g/2000g | 2000g |
| 4100g | 2000g/4000g | 4000g |
| 6100g | 2000g/5000g | 5000g |
| 8100g | 4000g/8000g | 8000g |

It is recommended that masses must meet or exceed ASTM Class 1 Tolerance. Calibration masses are available as accessories.

3.3.1 Internal Calibration (InCAL™)

On Explorer balances equipped with the InCal™ feature, calibration can be accomplished using an internal calibration mass. When the balance requires calibration, a screen prompt of CAL NOW appears. Internal calibration can be performed at any time providing the balance has warmed up to operating temperature.

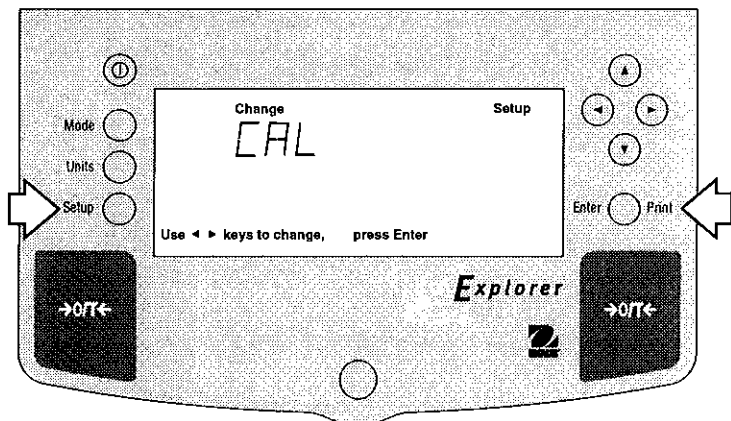

Procedure

- Press the **Setup** button, CAL is displayed.
- Press **Enter** button, CAL TYPE is displayed.

NOTES:

DO NOT DISTURB THE BALANCE DURING CALIBRATION. IF THE MESSAGE UNSTBLE IS DISPLAYED, THE BALANCE WAS UNABLE TO ACQUIRE STABLE DATA DURING INTERNAL CALIBRATION. THE BALANCE WILL CONTINUE TO PERFORM INTERNAL CALIBRATION UNTIL READINGS STABILIZE. THE BALANCE WILL THEN COMPLETE THE INTERNAL CALIBRATION FUNCTION.

TO EXIT INTERNAL CALIBRATION MODE BEFORE COMPLETION, PRESS ENTER OR SETUP BUTTONS.

STABILITY CAN BE AFFECTED BY TEMPERATURE, AIR CURRENTS, VIBRATION, ETC...

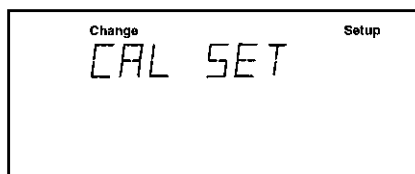
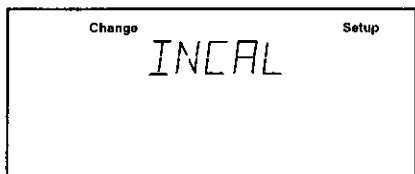
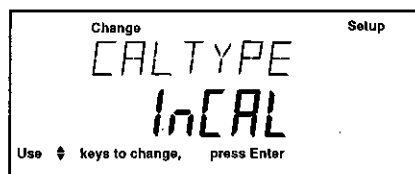
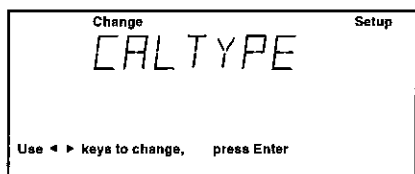

- Press **Enter** button, CAL TYPE InCAL is displayed.

- Press **Enter** button, INCAL is displayed.

NOTE: If a weight is left on the pan, the balance will display CLR PAN (remove the weight from the pan). The balance automatically resumes calibration.

After a few seconds, CAL SET is displayed (the internal weight is positioned and then removed), the display then returns to WEIGH mode.

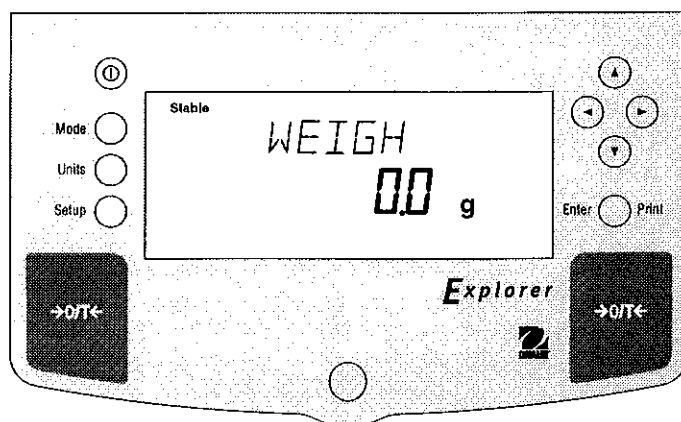

3.3.2 Span Calibration

Span calibration utilizes two calibration points, one at zero and the other at full span or incremental values starting at 25% of full capacity. As an example, an 8.1kg balance will accept either 2kg, 4kg, 6kg or 8kg for span calibration. Values which are below or in between will not be accepted and the balance will display its maximum capacity. Sample display illustrates an 8.1 kg balance

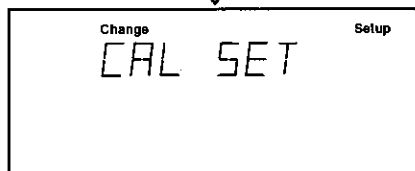
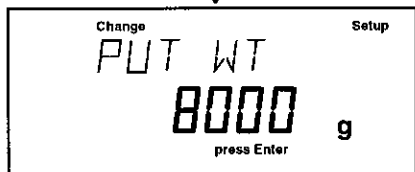
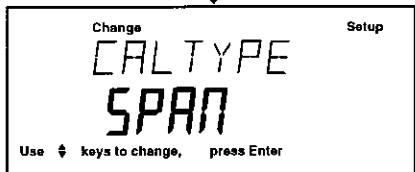
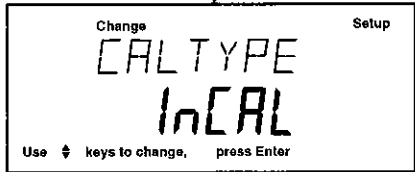
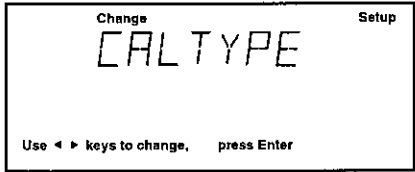
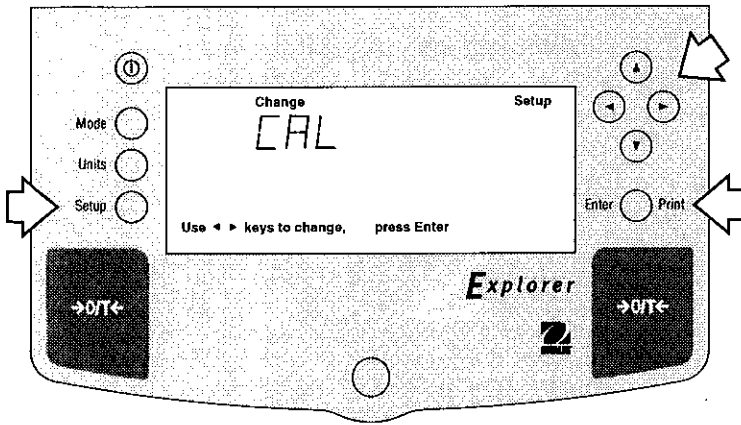

Procedure

- Press the **Setup** button, CAL is displayed.
- Press **Enter** button, CAL TYPE is displayed.
- Press **Enter** button, CAL TYPE InCAL is displayed.
- Press **▲** button to select SPAN calibration, CAL TYPE SPAN is displayed.
- Press **Enter** button, WORKING is displayed.

NOTE: If a weight is left on the pan, the balance will display CLR PAN (remove the weight from the pan). The balance automatically resumes calibration.

- Display changes to PUT WT 8000 g. The displayed weight is the full capacity of the balance.
- Place specified calibration mass on pan.

NOTE: For an 8.1kg balance, either 2kg, 4kg, 6kg or 8kg can be used for span calibration. The PUT WEIGHT message indicates the calibration mass that is on the pan.

- Press **Enter** button, WORKING is displayed. After a few seconds CAL SET is displayed, the display then returns to WEIGH mode.

Span calibration is completed.

- Remove calibration mass from the pan.

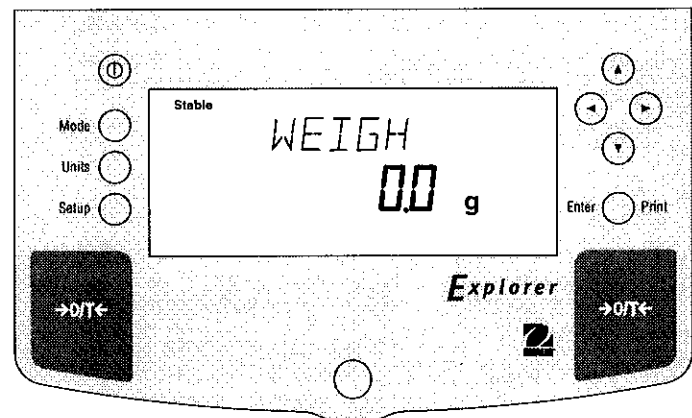

3.3.3 User Calibration

User calibration is used when it is desired to calibrate the balance using a mass of known value. To use this calibration feature, proceed as follows:

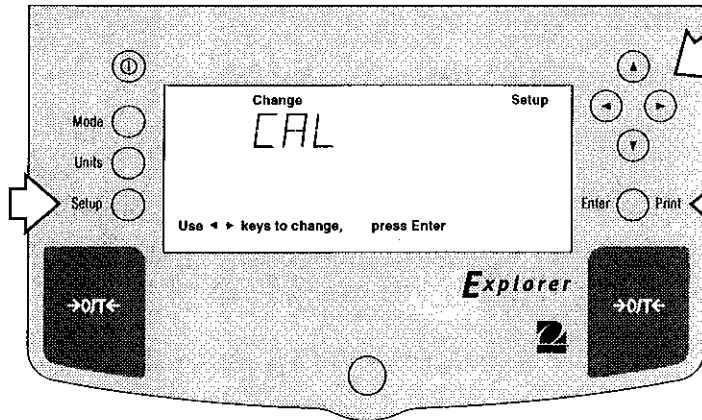

Procedure

- Press the **Setup** button, CAL is displayed.
- Press **Enter** button, CAL TYPE is displayed.
- Press **Enter** button, CAL TYPE InCAL is displayed.
- Press **▲** button twice to select USER calibration, CAL TYPE USER is displayed.
- Press **Enter** button, the display indicates the last calibration mass value which was entered with the first digit flashing. (Sample illustrates 2000g).
- Press **▲** **▼** and or **◀** **▶** and enter the desired mass value. This number must be at least 25% of the full span value.
- Press **Enter** button, WORKING is displayed.

NOTE: If a weight is left on the pan, the balance will display CLR PAN (remove the weight from the pan). The balance automatically resumes calibration.

- Display changes to PUT WT 2000 g.
- Place specified calibration mass on pan.
- Press **Enter** button, WORKING is displayed. After a few seconds CAL SET is displayed, the display then returns to WEIGH mode.

User calibration is completed.

- Remove calibration mass from the pan.

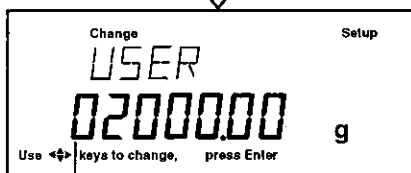
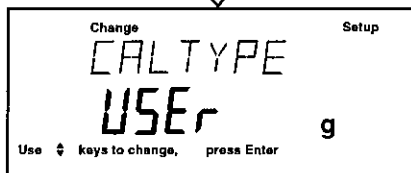
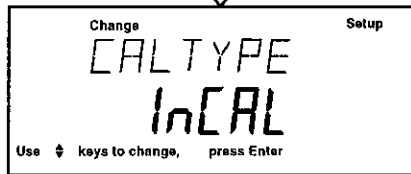
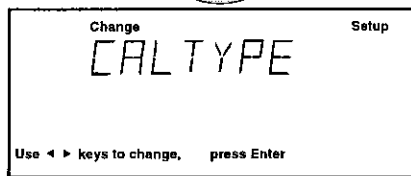
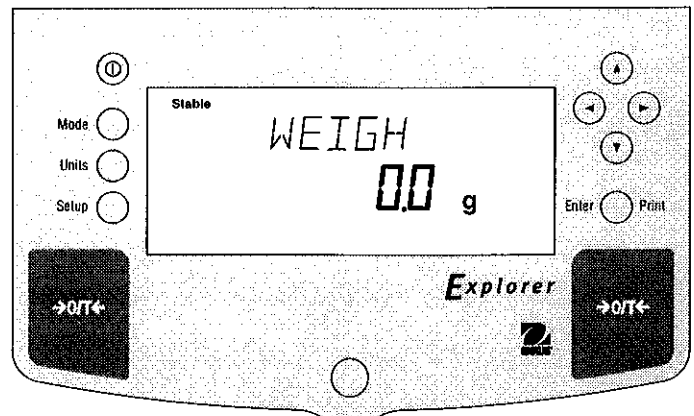

(FLASHING)

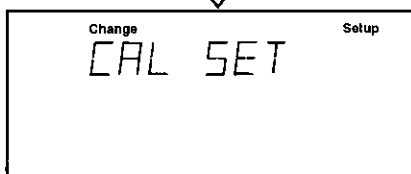

3.3.4 Linearity Calibration

Linearity calibration utilizes three calibration points, one at zero, center span and full span. This method minimizes deviation between actual and displayed weights within the balance's weighing range. Three weight values are used; zero, a weight value at midpoint of the balance's weighing range and a weight value at or near the specified capacity. Sample display illustrates an 8.1 kg balance. Sample display illustrates an 8.1 kg balance.

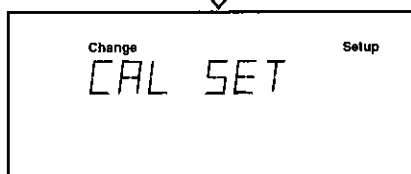
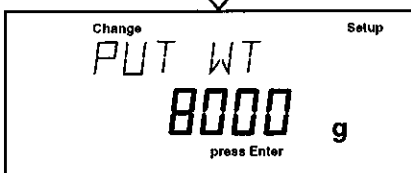
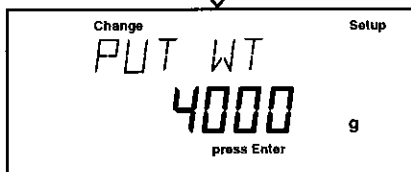
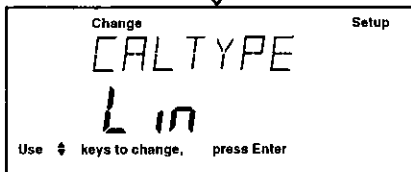
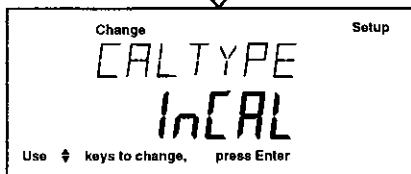
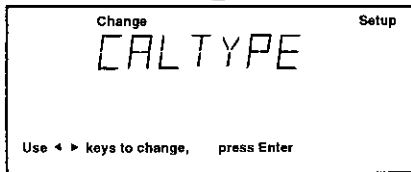
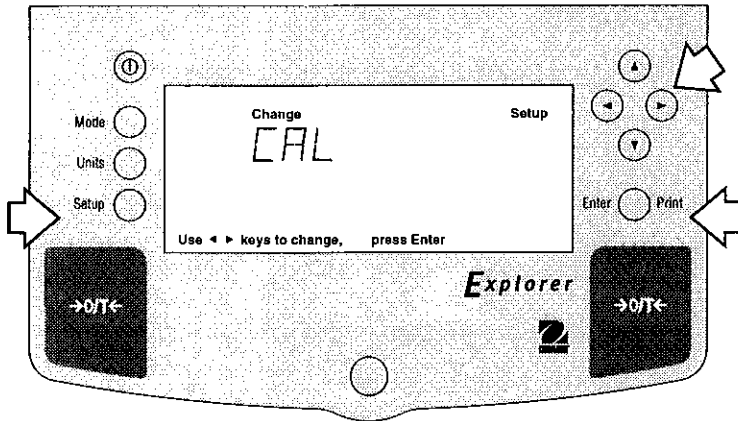

Procedure

- Press the **Setup** button, CAL is displayed.
- Press **Enter** button, CAL TYPE is displayed.
- Press **Enter** button, CAL TYPE InCAL is displayed.
- Press **▲** button three times to select LIN calibration, CAL TYPE Lin is displayed.
- Press **Enter** button, WORKING is displayed.

NOTE: If a weight is left on the pan, the balance will display CLR PAN (remove the weight from the pan). The balance automatically resumes calibration.

- Display changes to PUT WT 4000 g. The displayed weight is half the capacity of the balance.
- Place specified calibration mass on pan.
- Press **Enter** button, WORKING is displayed. After a few seconds display changes to PUT WT 8000 g. The displayed weight is the full capacity of the balance.
- Place specified calibration mass on pan.
- Press **Enter** button, WORKING is displayed. After a few seconds CAL SET is displayed, the display then returns to WEIGH mode.

Linearity calibration is completed.

- Remove calibration mass from the pan.

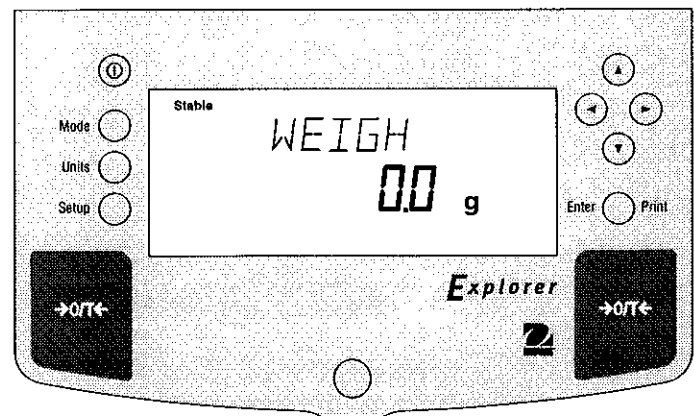

3.3.5 Calibration Test

Calibration test feature allows a check of a known calibration mass against the last stored calibration information in the balance. Sample display illustrates an 8.1 kg balance.

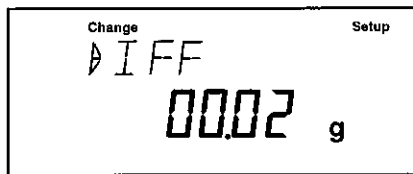
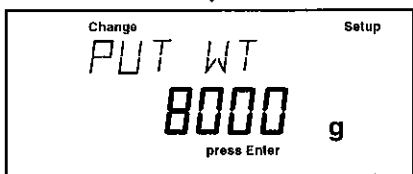
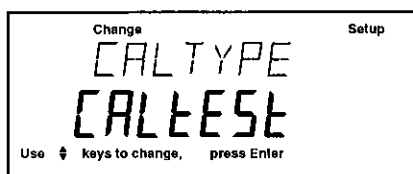
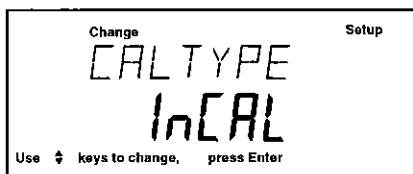
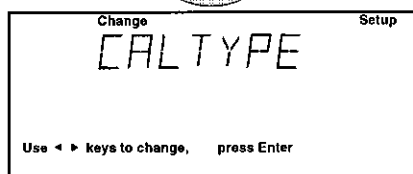
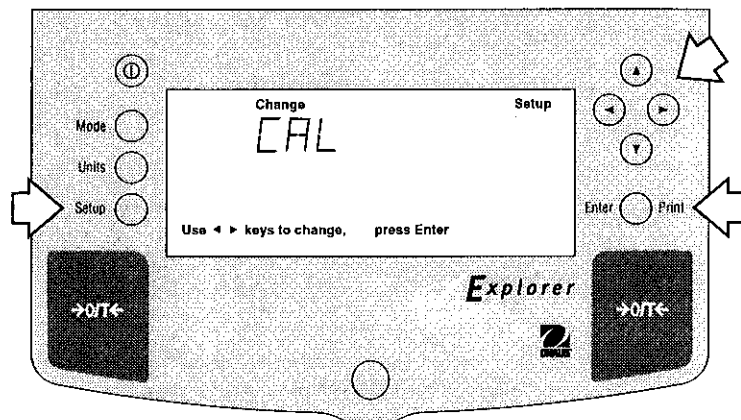

Procedure

- Press the **Setup** button, CAL is displayed.
- Press **Enter** button, CAL TYPE is displayed.
- Press **Enter** button, CAL TYPE InCAL is displayed.
- Press **▲** button to select CALTEST calibration, CALtEST is displayed.
- Press **Enter** button, WORKING is displayed.

NOTE: If a weight is left on the pan, the balance will display CLR PAN (remove the weight from the pan). The balance automatically resumes calibration.

- Display changes to PUT WT 8000 g. The displayed weight is the full capacity of the balance.
- Place specified calibration mass on pan.
- Press **Enter** button, WORKING is displayed. After a few seconds, WEIGH DIFF is displayed. The display now indicates the actual difference in weight between what value was just placed on the pan and the previous weight value which was stored in the balance. After approximately 8 seconds, the display returns to the WEIGH mode.
- Remove calibration test mass from the pan.

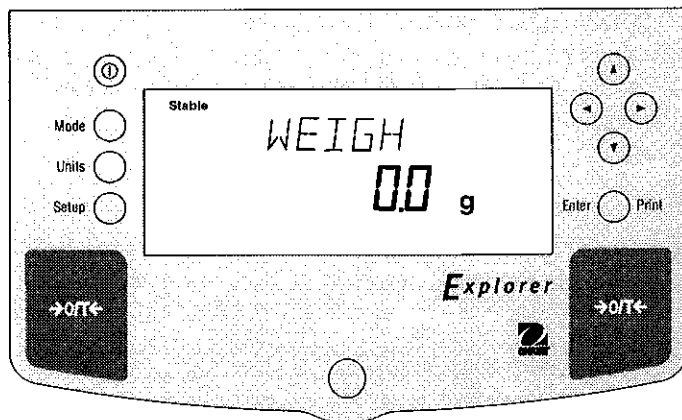

3.3.6 Calibration GLP Printout

If any option in the GLP Set Menu is turned On, GLP automatically prints data after calibration is completed.

Span Calibration Printout

When performing Span calibration with all GLP options turned on, a printout is automatically made after the calibration is completed.

```
----- SPAN CAL -----  
7/01/97  1:00:00 PM  
Bal Id 1234  
Cal:      1000.00g  
Old:      1000.00g  
Dif:      0.00g  
Wt. Ref.....  
USER NO 2056853  
PROJ NO 100012  
Name.....  
  
----- END -----
```

InCAL™ Calibration Printout

When performing InCAL™ calibration with all GLP options turned on, a printout is automatically made after the calibration is completed.

```
----- INCAL -----  
7/01/97  1:00:00 PM  
Bal Id 1234  
Cal:      1000.00g  
Old:      1000.00g  
Dif:      0.00g  
Wt. Ref.....  
USER NO 2056853  
PROJ NO 100012  
Name.....  
  
----- END -----
```

Linearity Calibration Printout

When performing a Linearity calibration with all GLP option turned on, a printout is automatically made after the calibration is completed.

```
----- LIN CAL -----  
7/01/97  1:00:00 PM  
Bal Id 1234  
Cal:      1000.00g  
Old:      999.08g  
Dif:      0.02g  
Wt. Ref.....  
USER NO 2056853  
PROJ NO 100012  
Name.....  
  
----- END -----
```

Calibration Test Printout

When performing a Calibration Test with all GLP options turned on, a printout is automatically made after the calibration is completed.

```
----- CAL TEST -----  
7/01/97  1:00:00 PM  
Bal Id 1234  
Cal:      1000.00g  
Act:      1000.02g  
Dif:      0.02g  
Wt. Ref.....  
USER NO 2056853  
PROJ NO 100012  
Name.....  
  
----- END -----
```

3.4 Weighing

NOTE: The Explorer balances are shipped with grams only enabled. When the balance is to be used with other Type Approved/Legal for Trade units of measure, the desired unit must be enabled. Refer to paragraph 4.9 to enable other measuring units.

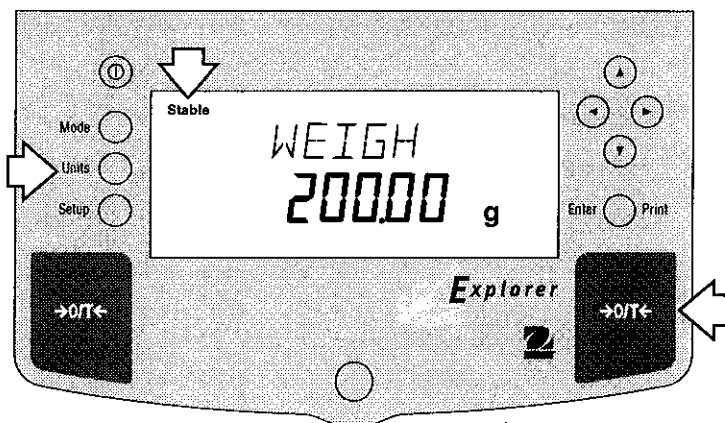

Procedure

- Press **→O/T←** to rezero the display.
- Press **Units** button to select measuring unit.
- Press **◀** or **▶** button for desired measuring unit.
- Press **Enter** button, balance is now ready for weighing.
- Place the object(s) or material to be weighed on the pan. Example illustrates a 200 gram weight.
- Wait for the stability indicator to appear before reading the weight.

Zero/Tare

When weighing material or objects that must be held in a container, taring stores the container weight in the balance's memory, separate from the weight of the material in the container.

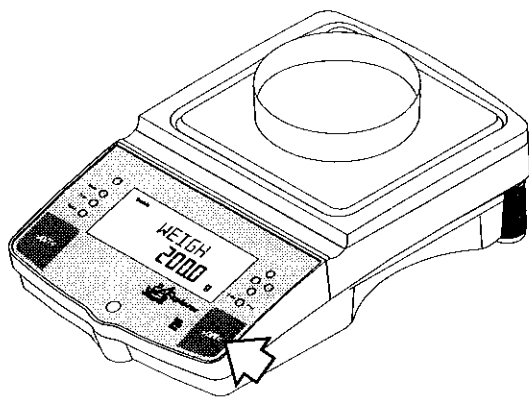

(Example Container 200g)

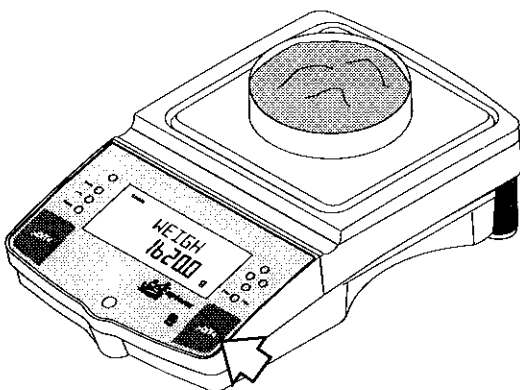

(Example Material 1620g)

Procedure

- Press **→O/T←** with no load on the pan to set the balance to zero.
- Place an empty container on the pan. Its weight is displayed.
- Press **→O/T←** the display blanks until stable weight readings are received, then indicates zero. The container's weight is stored in memory.
- Add material to the container. As material is added, its net weight is displayed.
- Removing the container and material from the platform will cause the balance to display the container's weight as a negative number. The tared weight will remain in memory until **→O/T←** is pressed again or the balance is turned off.
- Pressing **→O/T←** resets the balance to zero.

3.5 Percent Weighing

Percent Weighing is **enabled only** when Percent is turned ON. Percent weighing permits you to place a reference load on the balance, then view other loads as a percentage of the reference. The load you place on the pan as a reference may be displayed as any percentage you select from 5% to 100% (in 1% increments). One hundred percent does not necessarily have to represent the reference load. Subsequent loads, displayed as a percentage of the reference are limited only by the capacity of the balance. The default setting is Reference 100%. Refer to paragraph 4.8 to enable percent weighing.

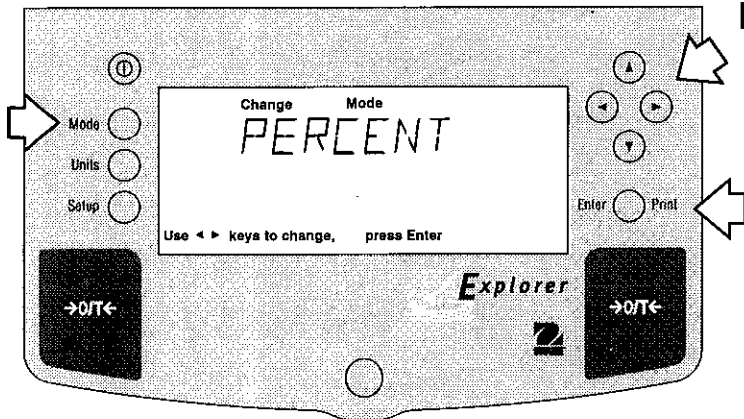

Procedure

- Press the **Mode** button.
- Press ◀ or ▶ button until PERCENT is displayed.
- Press **Enter** button, PUT>PAN 100% is displayed. If a container is used, the balance can be tared at this point.
- Put the reference load on the pan.
- Press ▲ or ▼ button and select reference weight percentage (Percent Range 5 to 100). Hold button down for fast change.
- Press **Enter** button to save setting, WORKING is displayed ... calculating reference weight.

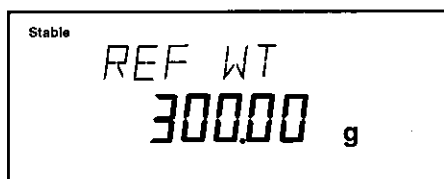
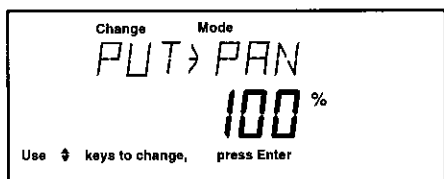

Balance displays reference weight for five seconds in selected measuring unit, then displays the percentage.

- Remove the reference weight from the pan and replace it with another load. The second load is displayed as a percentage of the reference.

NOTE: The PERCENT display (number of digits) is a function of the accuracy of the balance and the size of the reference weight. The display examples were with a 300g mass used with an 8.1 kilogram balance.

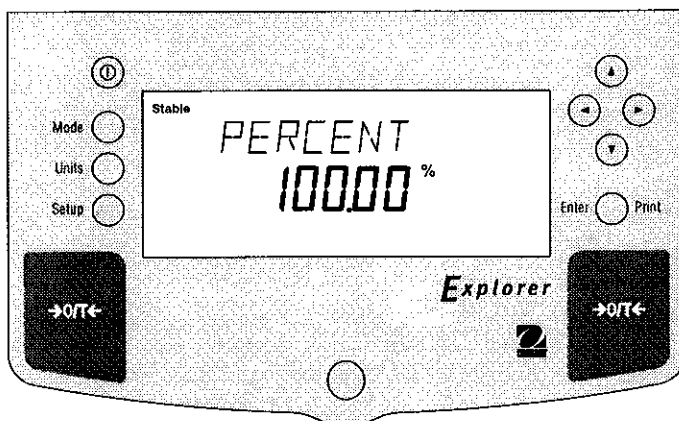

3.6 Parts Counting

Parts Counting is **enabled only** when Count is turned ON in the Function submenu and selected with the **Mode** button. In the parts counting mode, the balance displays the quantity of parts you place on the pan. Since the balance determines the quantity based on the average weight of a single part, all parts must be reasonably uniform in weight.

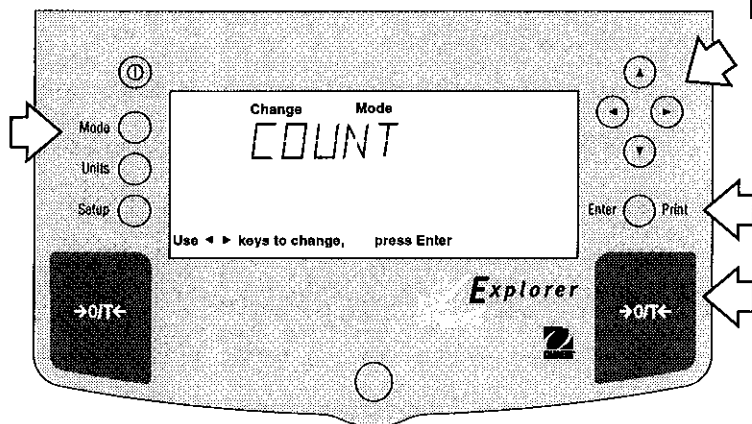

Procedure

- Press the **Mode** button.
- Press ◀ or ▶ button until COUNT is displayed.
- Press **Enter** button to save setting, PUT>PAN 100 PC is displayed.
- Press >O/T< if taring is required.
- Press ▲ or ▼ button and select sample size. Sample size is 5 to 1000 pieces.
- Place sample size on the pan.
- Press **Enter** button to continue, display indicates WORKING.

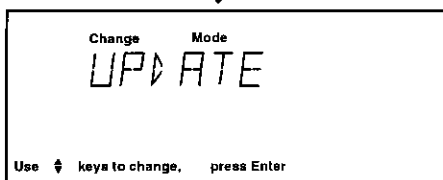
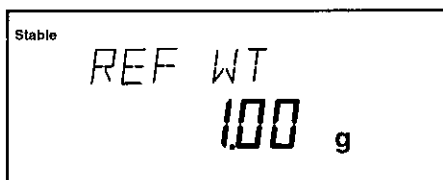
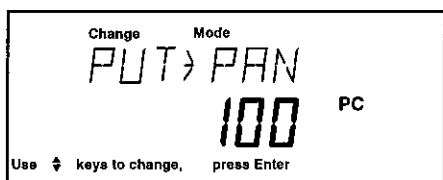

Balance displays the reference weight of an individual piece part for five seconds and then displays the total number pieces on the pan.

- Remove the sample and place parts to be counted on the pan. Balance displays number of pieces.

Update

Update is a function which permits placing additional samples which are greater than the value of the original sample but less than three times the value. This action increases the accuracy of the measurement.

- Place sample on the pan which is at least one but not more than three times the original sample size.
- Press **Mode** button, COUNT is displayed.
- Press **Enter** button, UPDATE is displayed.
- Press **Enter** button, WORKING is displayed then the reference weight followed by the new sample size.

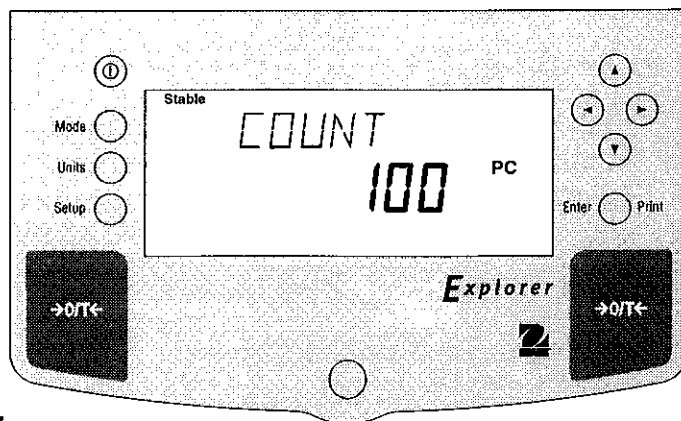

3.7 Animal Weighing

Animal Weighing is **enabled only** when Animal is turned ON in the Function submenu.

Procedure

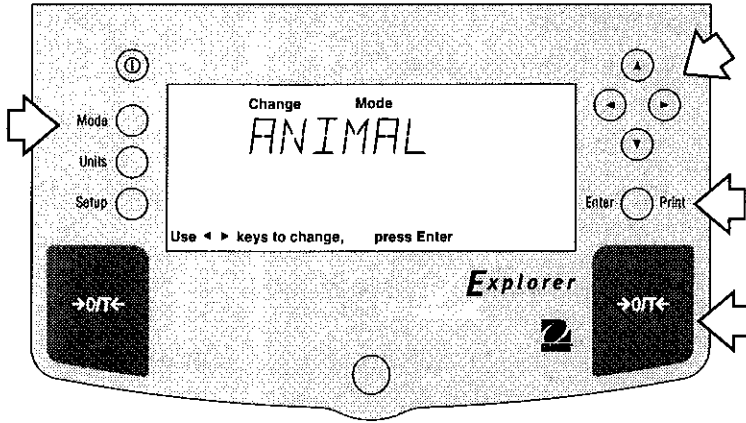

- Press the **Mode** button.
- Press ◀ or ▶ button until ANIMAL is displayed.
- Press **Enter** button to continue, LEVEL is displayed.
- Press ▲ or ▼ button to change animal weighing level, 0, 1, 2 or 3. 0 level represents an inactive subject, 3 is used for a very active subject.
- Press **Enter** button to continue, AUTO is displayed.
- Press ▲ or ▼ button to select AUTO ON or OFF.
- Press **Enter** button to continue.

When the AUTO function is set ON, different subjects can be weighed one after another without pressing any buttons. When the balance displays READY, simply place subject on pan.

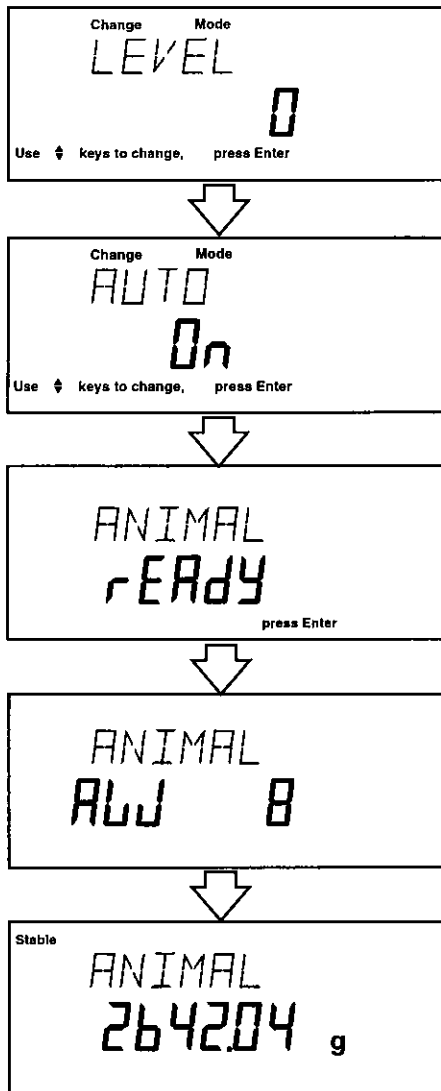

Starting Animal Cycle

- Place animal container if used on pan.
- Press →O/T← to tare the container.
- Place subject on pan.
- The animal cycle will automatically start if AUTO was set to ON.
- Press **Enter** button to start animal cycle if AUTO was set to OFF.

During Animal Cycle

- Display shows countdown to AW0.

Completed Animal Cycle

- Balance displays weight until subject is removed from the pan.

3.8 Printing Data

Printing data to an external computer or printer requires that the communications parameters in the Setup menu, Print options and communication parameters be set first. Refer to page 23 Print menu settings and page 24 for RS232 communication settings.

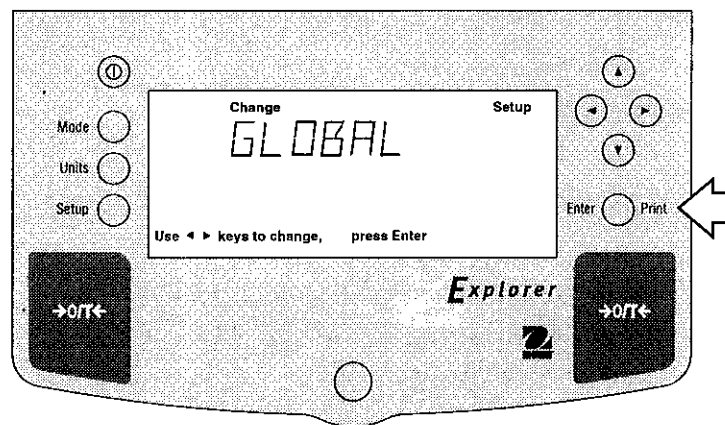

Procedure

- Press the **Print** button. Printing to an external printer or computer will occur each time the Print button is pressed unless autoprint feature is turned on in which case printing can occur in a continuous fashion, at specified intervals or each time a stable reading is achieved.

Sample printout is shown below with time turned on.

SAMPLE PRINTOUT

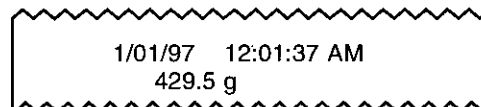

For a review of of printing samples, refer to Section 4 Setting Up Your Balance. What is printed is controlled by the GLP Set Menu and the selection of GLP Cont. or GLP Tare in the Print Menu.

4. SETTING UP YOUR BALANCE

4.1 Setting Date and Time

Your Explorer balance provides date and time data which can be viewed on a computer or printed out on an external printer. When you put your new instrument into operation for the first time, you should enter the current date and the time. These settings are retained as long as the balance remains connected to a power source.

Date

Date is a feature which enables the balance to be set to a U.S.A. date standard or European date standard. U.S. standard has the month, date, followed by the year, each separated by (/) in the printout. The European date standard has the day first, followed by the month and then the year; each separated by a period. The default setting is **U.S.A. Standard**.

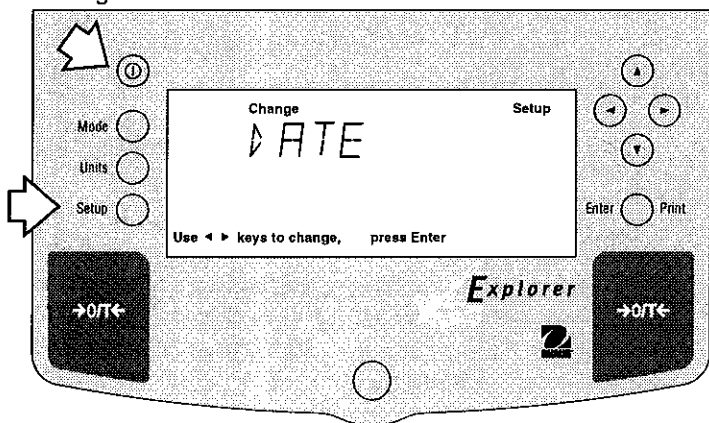

Procedure

- Press the **Setup** button, CAL is displayed.
- Press ◀ or ▶ button and select Date from the menu.
- Press **Enter** button, TYPE is displayed.
- Press **Enter** button, SET M d y, d M y, y M d, M y d, y d M, or d y M is displayed.
- Press ▲ or ▼ button and select type of date.
- Press **Enter** button, SAVED is displayed, then SET is displayed.
- Press **Enter** button, first digit of date is flashing.
- Using arrow buttons, enter the correct date.
- When the correct date is entered, press **Enter** button, SAVED displays momentarily and EXIT appears.
- Press **Enter** button, balance returns to a weighing mode.

Time

Time is a feature which enables the balance to be set to the current time in either U.S.A. standards (12 hour periods) or European/Military standards (24 hour periods). The default setting is **U.S.A. Standard**.

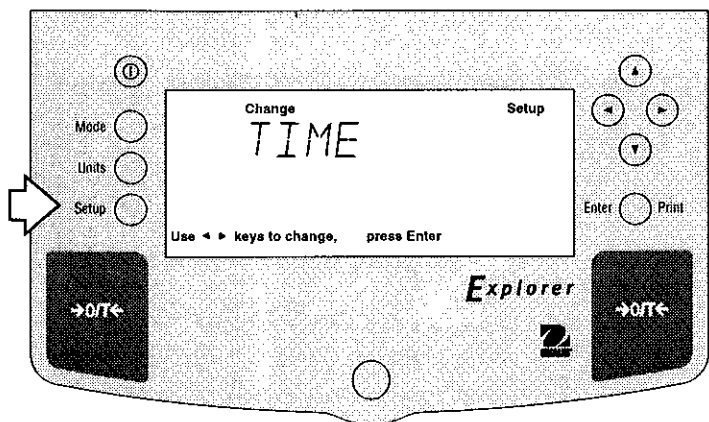

Procedure

- Press the **Setup** button, CAL is displayed.
- Press ◀ or ▶ button and select Time from the menu.
- Press **Enter** button, TYPE is displayed.
- Press **Enter** button, TYPE 12 hr is displayed.
- Press ▲ or ▼ button and select 12 hr or 24 hr.
- Press **Enter** button, SAVED is displayed momentarily then SET is displayed.
- Press **Enter** button, SET with time is flashing.
- Using arrow buttons, enter the correct time.
- When the correct time is entered, press **Enter** button, SAVED displays momentarily and EXIT appears.
- Press **Enter** button, balance returns to a weighing mode.

Adjustments up to ± 60 seconds a month can be made to the balance internal clock. Repeat the first seven steps, ADJUST is displayed. Using arrow buttons, enter time correction and press **Enter** button.

4.2 Readout

The Readout menu is used to adapt the balance to environmental conditions. It contains four submenus: **Stable**, **Auto 0**, **Filter**, **Lock** and **Exit**. Lock enables you to program balance parameters and to lock the settings.

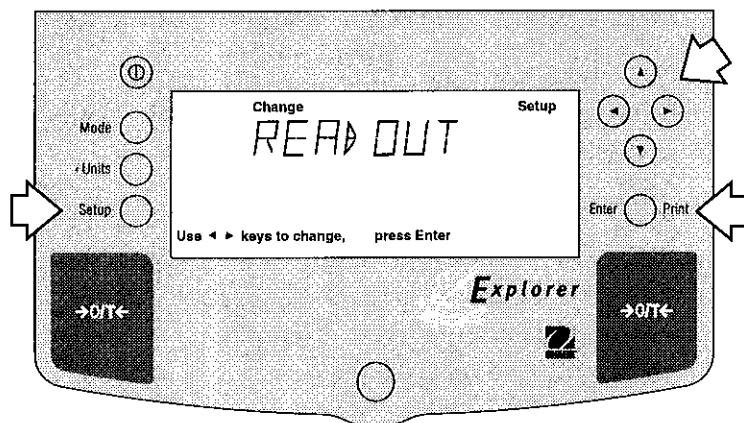

Procedure

To select any of the items in the Readout menu, proceed as follows:

- Press the **Setup** button, CAL is displayed.
- Press ◀ or ▶ button until READOUT is displayed.
- Press **Enter** button to save setting.
- Press ◀ or ▶ button until either STABLE, AUTO 0, FILTER, LOCK or EXIT is displayed.
- Press **Enter** button to save setting.
- Press ▲ or ▼ button and select the desired menu setting.
- Press **Enter** button SAVED is displayed.
- Press ◀ or ▶ button to continue or EXIT.
- Press **Enter** button to save setting.

Stability

The stability range specifies the weighing results and must be within a preset tolerance limit for a certain time to turn the stability indicator ON. When a displayed weight changes beyond the allowable range, the stability indicator turns OFF, indicating an unstable condition. Factory default setting is shown in bold type.

- .5 d Smallest range: stability indicator is ON only when displayed weight is within .5 divisions.**
- 1 d Reduced range.
- 2 d Normal range.
- 5 d Largest range, stability indicator is ON even though displayed weight changes slightly.

When the RS232 interface is configured to print stable data only, the stability range also governs data output. Displayed data will only be output if it is within the selected stability range.

Auto-Zero

Auto-Zero minimizes the effects of temperature changes and shift on the zero reading. The balance maintains the zero display until the threshold is exceeded. Factory default setting is shown in bold type.

- OFF Turns Auto-Zero OFF.
- .5 d Sets threshold to .5 divisions.**
- 1 d Sets threshold to 1 division.
- 3 d Sets threshold to 3 divisions.

Filter

Filter compensates for vibration or excessive air currents. Default settings are shown bold.

- 0- reduced stability, fastest stabilization time.
- 1- normal stability, normal stabilization time**
- 2- more stability, slow stabilization time.
- 3- maximum stability, slowest stabilization time.

Lock

Lock ON/OFF can only be changed when the hardware Lock Switch is set OFF/disabled. A menu is locked when the menu lock is set ON and the Lock switch is ON. Lock when selected and turned on, locks all of the entries made under the Readout menu. In the locked condition, items may be looked at but not changed in the menu. When set off, entries may be changed. **OFF** is the default setting.

4.3 Good Laboratory Practices (GLP) Data

The GLP Data submenu enables the storage of a user identification number (7 digits) and/or a project number (digits). When entered into the balance, the identification number and project number are available when printing providing they are turned on in the GLP Set submenu. A lock setting is also available which locks in the user identification and project number.

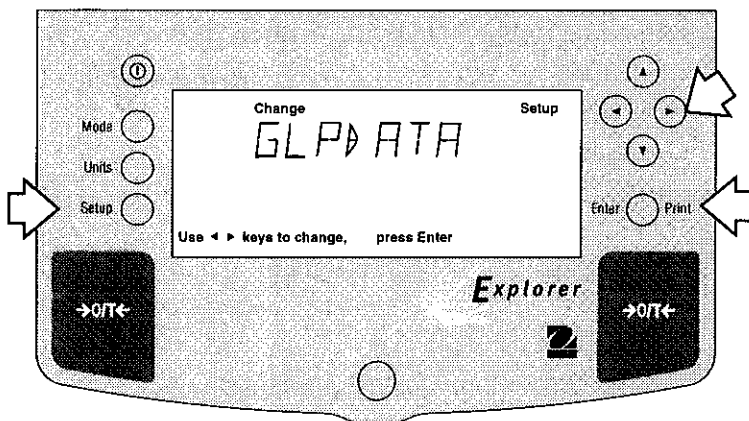

Procedure

To select any of the items in the GLP Data menu, proceed as follows:

- Press the **Setup** button, CAL is displayed.
- Press ◀ or ▶ button until GLP DATA is displayed.
- Press **Enter** button to continue.
- Press ◀ or ▶ button until either USER NO, PROJ NO, LOCK or EXIT is displayed.
- Press **Enter** button to continue.
- Press ◀ ▶ or ▲ ▼ buttons as directed by the display and enter a 7 digit number for the user ID number.
- Press **Enter** button to save setting.
- Press ◀ or ▶ button until either USER NO, PROJ NO, LOCK or EXIT is displayed.
- Press **Enter** button to continue.
- Press ◀ ▶ or ▲ ▼ buttons as directed by the display and enter a 7 digit number for the project number.
- Press **Enter** button to save setting.
- Press ◀ or ▶ button to select next item or EXIT.
- Press **Enter** button to continue.

4.4 Good Laboratory Practices (GLP) Set

Good Laboratory Practices (GLP) Set submenu allows the selection and will permit printing of Time, Balance Identification Number, User Identification Number, Project Number, Difference and Name data to be printed. When the selected items are set to ON, these items are not displayed. The default setting is OFF. When an external printer is used, and all items are set ON and the balance is calibrated, the printer will print out calibration data for audit trail purposes and will indicate date, and time. (It should be noted that the User ID number and Project number must be entered in the GLP Data submenu before printed data is available).

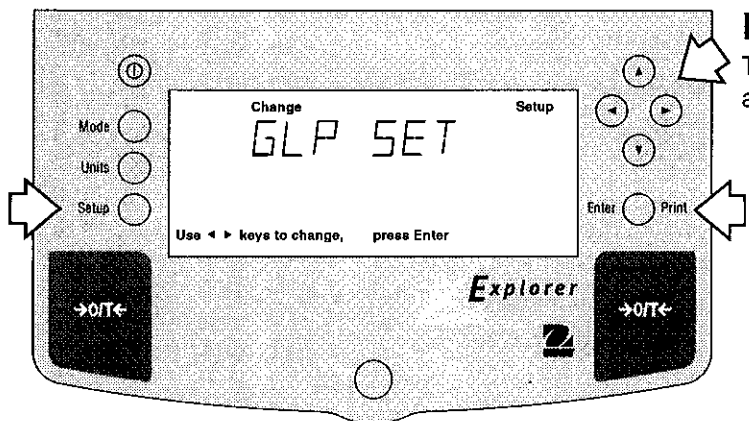

Procedure

To select any of the items in the GLP Set menu, proceed as follows:

- Press the **Setup** button, CAL is displayed.
- Press ◀ or ▶ button until GLP SET is displayed.
- Press **Enter** button to save setting.
- Press ◀ or ▶ button until either TIME, BAL ID, USER NO, PROJ NO, DIFF, NAME, LOCK or EXIT is displayed.
- Press **Enter** button to save setting.
- Press ▲ or ▼ button and select either ON or OFF.
- Press **Enter** button to save setting.
- Press ◀ or ▶ button to continue or EXIT.
- Press **Enter** button to save setting.

4.5 Print

The Print menu provides a number of options which can be turned ON or OFF. It contains eight submenus: **Auto Print**, feature which includes selection of Off, Continuous, Interval and on Stability, **Inter**, specifies time interval for automatic output of displayed data, **Stable** data-only feature, **Numeric** only or full display data for output, **GLPCont**, **GLPTare**, **Reference** which prints reference weight value and **Lock** which enable you to program balance parameters and to lock the settings.

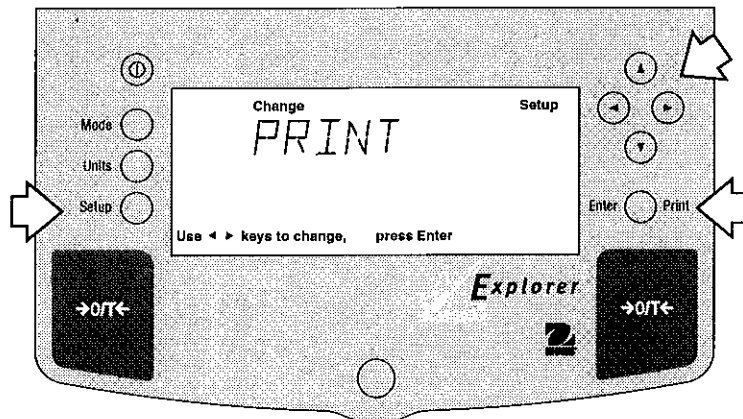

Procedure

- Press the **Setup** button, CAL is displayed.
- Press ◀ or ▶ button until PRINT is displayed.
- Press **Enter** button to continue.
- Press ◀ or ▶ button until either AUTOPRT, INTER, STABLE, NUMERIC, GLPCont, GLPTARE, REFEREN, LOCK or EXIT is displayed.
- Press **Enter** button to continue.
- Press ▲ or ▼ button and select either menu setting or ON or OFF.
- Press **Enter** button to save setting.
- Press ◀ or ▶ button to select next item or EXIT.
- Press **Enter** button to continue.

Auto Print Feature

When enabled, the Auto Print feature causes the balance to automatically output display data in one of three ways: continuously, at user specified time intervals, or upon stability. Default settings are shown bold.

| | |
|------------|--|
| OFF | when set on turns off the auto print feature |
| Cont | when set on, outputs printed data continuously |
| Inter | provides a user specified printing interval |
| On Stb | provides printed data only when a stable reading is achieved |

Interval

Can be set to provide a specified printing interval between 1 and 3600 seconds.

Print Stable Data Only

When set On, this feature permits only stable display data to be output. **OFF** is the default setting.

Print Numeric Data Only

When Numeric Data Only function is turned ON, this allows the balance to output numeric data only for RS232 output. **OFF** is the default setting.

4.5 Print (Cont.)

GLP Continuously

When the GLP Continuously function is set ON, allows the balance to output the GLP selections each time a weight value is printed to the printer. **OFF** is the default setting. The following example is with GLP Cont On.

Sample Printout

```

7/01/97  12:01:37 AM
  429.5 g

7/01/97  12:01:52 AM
Bal Id
  429.8 g

7/01/97  12:02:17 AM
Bal Id
USER NO 1000001
  429.8 g

7/01/97  12:02:43 AM
Bal Id
USER NO 1000001
PROJ NO 2000002
  429.5 g

7/01/97  12:02:43 AM
Bal Id
USER NO 1000001
PROJ NO 2000002
Name .....
  429.5 g
    
```

GLP Set Menu
Options Turned On

Time = On

Time = On
Balance ID = On

Time = On
Bal ID = On
User No. = On

Time = On
Bal ID = On
User No = On
Proj No = On

Time = On
Bal ID = On
User No = On
Proj No =
Name = On

GLP Once After Tare

When the GLP Tare function is set ON, allows the balance to output the GLP selections once after tare when the weight value is printed to the printer. **OFF** is the default setting. The following example is with GLP Once After Tare.

```

7/01/97  12:01:37 AM
  429.5 g
  429.6 g
  429.7 g
  429.7 g
  429.7 g
    
```

GLP Set Menu
Options Turned On

Time = On

Reference

When the Reference function is set ON, prints the value of weight used as a reference in either Percent and Parts Counting modes. **OFF** is the default setting.

Lock

Lock ON/OFF can only be changed when the hardware Lockswitch is set OFF/unlocked. A menu is locked when the menu lock is set ON and the Lockswitch is ON. Lock when selected and turned on, locks all of the entries made under the Print menu. In the locked condition, items may be looked at but not changed in the menu. When set off, entries may be changed. **OFF** is the default setting.

4.6 RS232

The RS232 menu provides communication parameters which can be set to accommodate external printers or computers. It contains five submenus: **Baud rate**, **Parity**, **Data**, **Stop bit** and **Lock ON or OFF** which enable you to program balance parameters and to lock the settings.

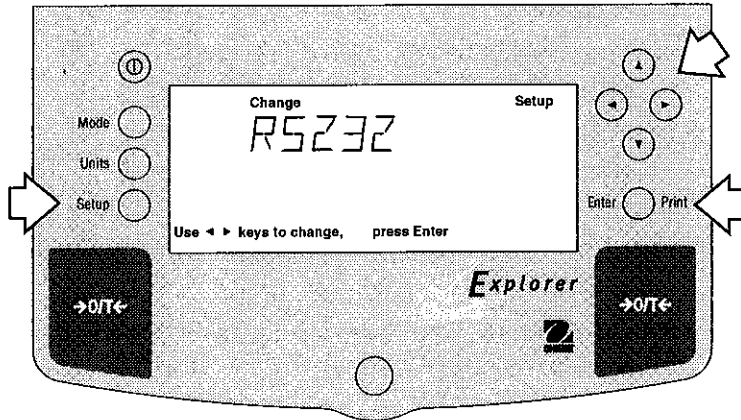

Procedure

- Press the **Setup** button, CAL is displayed.
- Press ◀ or ▶ button until RS232 is displayed.
- Press **Enter** button to save setting.
- Press ◀ or ▶ button until either BAUD, PARITY, DATA, STOP, LOCK or EXIT is displayed.
- Press **Enter** button to save setting.
- Press ▲ or ▼ button and select the desired menu setting.
- Press **Enter** button to save setting.
- Press ◀ or ▶ button to continue or EXIT.
- Press **Enter** button to save setting.

Baud Rate

This submenu is used to select the desired baud rate. There are five available baud rates to choose from: 300, 1200, 2400, 4800 and 9600. The default setting is **2400**.

Parity

Parity can be set to Odd, Even or None. The default setting is **None**.

Data Bits

To set the number of data bits to 7 or 8. The default setting is 7.

Stop Bits

The number of stop bits can be set to 1 or 2. The default setting is 2.

Lock

Lock ON/OFF can only be changed when the hardware Lock Switch is set OFF/disabled. A menu is locked when the menu lock is set ON and the Lock switch is ON. Lock when selected and turned on, locks all of the entries made under the RS232 menu. In the locked condition, items may be looked at but not changed in the menu. When set off, entries may be changed. **OFF** is the default setting.

4.7 Legal for Trade (LFT)

Legal for trade (LFT) is a software controlled option which can be set LFT LOCK. When set to LFT LOCK, certain items in the Calibration, Readout, Print, Function and Units menus are automatically preset and locked to permit the balance to operate in a legal for trade application and works in conjunction with a Lock Out switch. Default setting is UNLOCKED. See default table.

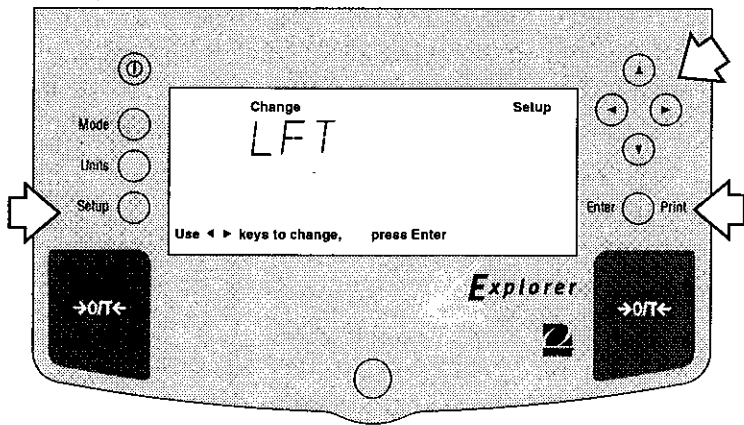

Procedure

- Press the **Setup** button, CAL is displayed.
- Press ◀ or ▶ button until LFT is displayed.
- Press **Enter** button to continue.
- Press ◀ or ▶ button and select LFTLOCK.
- Press **Enter** button to continue.
- Press ▲ or ▼ button and select either ON or OFF.
- Press **Enter** button to save setting.
- Press ◀ or ▶ button to select next item or **EXIT**.
- Press **Enter** button to continue.

NOTE: For legal for trade applications, the balance must be physically sealed. Refer to section on LFT Sealing.

DEFAULT TABLE

| LFT and Lockswitch | Menu lock | Default Value |
|-----------------------|------------|------------------------------|
| Date Menu | Unlocked | |
| Time Menu | Unlocked | |
| Calibration Menu | | |
| Span, Linearity, User | Locked | |
| CalTest | Unlocked | |
| Internal Calibration | Unlocked | |
| Readout Menu | | |
| Stability | Unlocked | .5d (limited to .5d and 1d) |
| Auto zero | Unlocked | .5d (limited to OFF and .5d) |
| Filter Level | Unlocked | -1- |
| GLP Data Menu | Unlocked | |
| GLP Selections | Unlocked | |
| Print Options | Unlocked | |
| RS232 Menu | Unlocked | |
| LFT Menu | Lockswitch | Locked |
| Function menu | Locked | Weigh |
| Units Menu | Locked | Grams* |
| Global Menu | Locked | |
| Custom Menu | Unlocked | |

* Units oz and oz t cannot be simultaneously enabled.

If Print Numeric Data is turned ON, then Print Stable Data Only is locked ON.

When the balance is first turned ON and LFT has been previously set ON, the following display will appear if LFT is set in the menu and the Lock Switch is set ON.

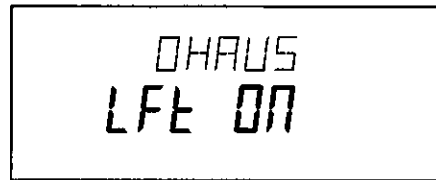

When the balance is first turned ON and LFT has been previously set ON, the following display will appear if LFT is set in the menu and Calibration menu is locked, and the Lock Switch is set ON.



The display check countdown appears only in the first 120 seconds after *plugging it in* and only when the balance has been previously set with Type Approved/ Legal for Trade set ON.

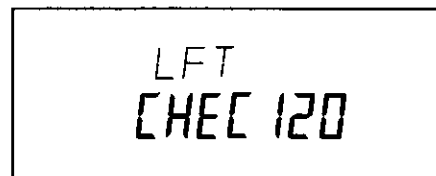

⋮



4.8 Mode

The Mode submenu permits the selection of five modes which can be turned ON or OFF. These modes are: **Weigh**, **Percent**, **Count**, **Animal** and **Lock**. Weigh is turned ON and all others have a default setting of **OFF**. When any of the modes are turned ON, they can be selected for operation from the Mode button.

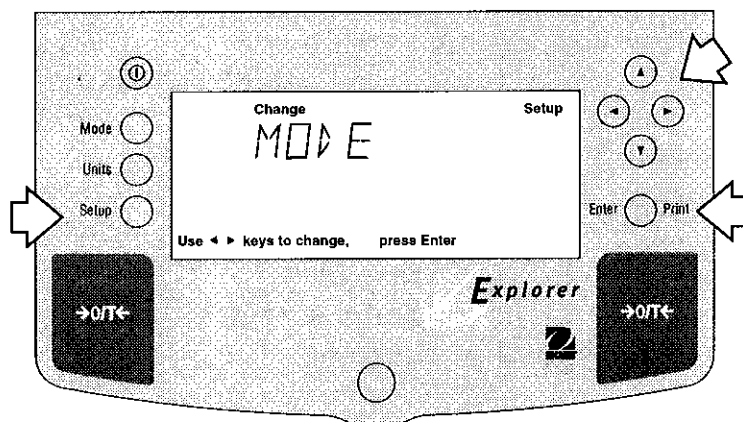

Procedure

- Press the **Setup** button, CAL is displayed.
- Press ◀ or ▶ button until MODE is displayed.
- Press **Enter** button to save setting.
- Press ◀ or ▶ button until either WEIGH, PERCENT, COUNT, ANIMAL, LOCK or EXIT is displayed.
- Press **Enter** button to save setting.
- Press ▲ or ▼ button and select either ON or OFF.
- Press **Enter** button to save setting.
- Press ◀ or ▶ button to continue or **EXIT**.
- Press **Enter** button to save setting.

Weigh

The Weigh submenu is always set to **ON** as a default.

Percent

Percent weighing permits you to place a reference load on the balance, then view other loads as a percentage of the reference. Selection is made using the **Mode** button. The default setting is **OFF**.

Count

Counting is used when counting quantities of parts. Selection is made using the **Mode** button. The default setting is **OFF**.

Animal

Animal weighing provides special settings to accommodate animal movements. Selection is made using the **Mode** button. The default setting is **OFF**.

Lock

Lock ON/OFF can only be changed when the hardware Lock Switch is set OFF/disabled. A menu is locked when the menu lock is set ON and the Lock switch is ON. Lock when selected and turned on, locks all of the entries made under the Function menu. In the locked condition, items may be looked at but not changed in the menu. When set off, entries may be changed. **OFF** is the default setting.

4.9 Units

The Units submenu permits the selection of the measuring units which can be turned ON or OFF and locked.

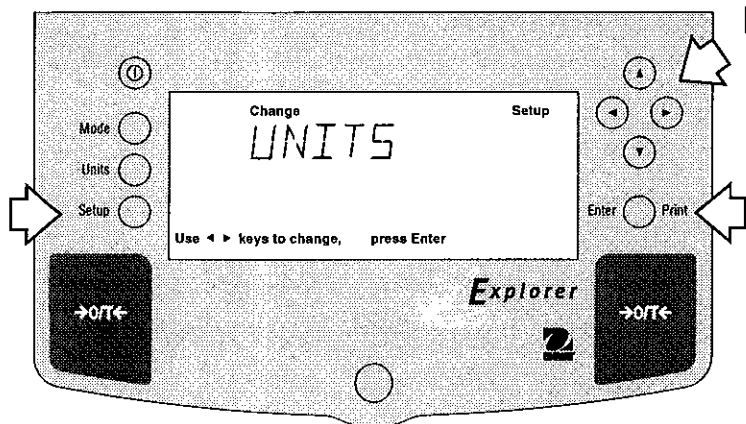

Procedure

- Press the **Setup** button, CAL is displayed.
- Press ◀ or ▶ button until UNITS is displayed.
- Press **Enter** button to continue.
- Press ◀ or ▶ button until desired measuring unit is displayed.
- Press **Enter** button to continue.
- Press ▲ or ▼ button and select either ON or OFF.
- Press **Enter** button to save setting.
- Press ◀ or ▶ button to select next item or EXIT.
- Press **Enter** button to continue.

Units

Measuring units settings are made using the Units button. This menu permits the measuring units to be turned ON or OFF. The default setting is **OFF**.

Lock

Lock when selected and turned on, locks all of the entries made under the Units button. The default setting is **OFF**.

4.10 Global

This menu contains three functions which can be set to either a yes or no type of operation. These functions are: **List**, **Reset** and **Version**. The default setting are **NO**. Global List is a convenient method of examining which parameters are set up in the balance. The parameters do not show up on the display but print out when selected. The Global menu contains the List function.

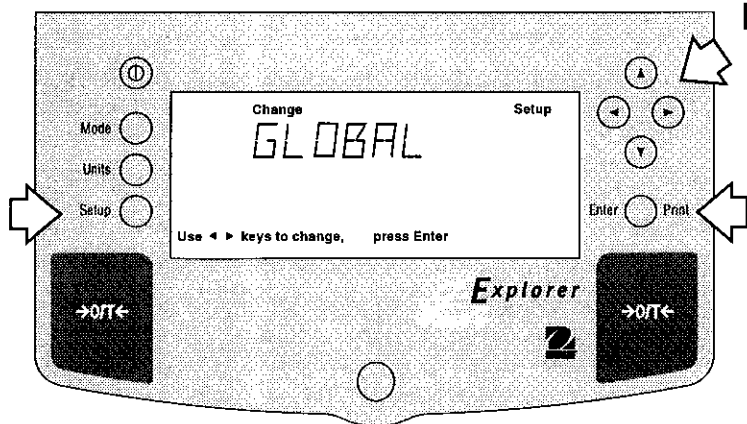

Procedure

- Press the **Setup** button.
- Press ◀ or ▶ button until GLOBAL is displayed.
- Press **Enter** button to continue.
- Press ◀ or ▶ button until either LIST, RESET, VERSION, LOCK or LIST is displayed.
- Press **Enter** button to continue.
- Press ▲ or ▼ button and select either YES or NO.
- Press **Enter** button to save setting.
- Press ◀ or ▶ button to select next item or **EXIT**.
- Press **Enter** button to continue.

4.10 Global (Cont.)

List

This submenu can be used to output a listing of current menu settings via the RS232 interface. When YES is selected, all menu settings will be output either to an external printer or computer. To use this feature, your balance must be connected to a computer or printer. The default setting is **OFF**.

SAMPLE PRINTOUTS

```

EXPLORER xxxxxx-xxx
Sr #x.xx OS#x.xx G#x.xx

Time= 12hr   3:19:51 PM
Date= m/d/y   7/09/97
Function = Weigh
ReadOut Menu
  Stb= 2 d
  AZT= .5 d
  Filter= 1
GLP Menu
  Time/Date= On
  Bal Id= On
  User No.= On
  Proj No.= On
  DIFF= On
  Name= On
Print Menu
  Auto Print= Off
  Interval= 7
  Stable Print= On
  NU= On
  GLP Cont = Off
  GLP on Tare = Off
  Print Ref= On
RS232 = 2400: N: 7: 2
  
```



The partial sample shown, indicates the status in the menus.

```

LFT is Off
Mode Menu
  WEIGH= On
  PERCENT= Off
  COUNT= Off
  ANIMAL= Off
Lock Switch is Off
Menu Locks
  RS232= Off
  READOUT= Off
  GLPSET= Off
  MODE= Off
  UNITS= Off
  PRINT= Off
  GLP Data = Off
  CAL= Off
  GLOBAL= Off
  CUSTOM= Off
Enabled Units:
  g
  custm
C. Units:
  1.000000 E0 x 1
  
```

Reset

Reset when set to yes will reset the balance to factory default settings. The default setting is **NO**.

Version

Displays software revision number for servicing purposes. This number is installed with the balance.

Lock

Lock when selected and set to YES, locks all of the entries made under the Global menu. The default setting is **NO**.

4.11 Custom Unit

Custom Unit is enabled when Custom Unit Setup under Units Menu is turned ON. This feature can be used to create your own custom weighing unit. It permits entering a conversion factor which the balance will use to convert grams to the desired unit of measure.

$$\begin{array}{rcccl} \text{Conversion} & & \text{Weight} & & \text{Weight} \\ \text{Factor} & \times & \text{in} & = & \text{in} \\ & & \text{grams} & & \text{custom unit} \end{array}$$

Conversion factors are expressed in scientific notation and entered into the balance in three parts:

- a number between 0.1 and 1.999999 called the mantissa
- a power of 10 called the exponent
- a least significant digit (LSD)

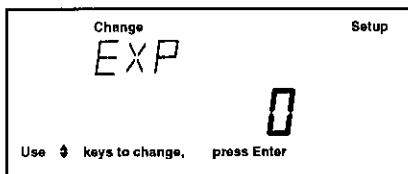
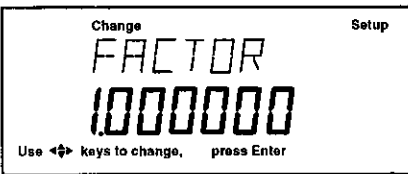
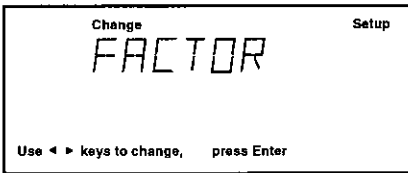
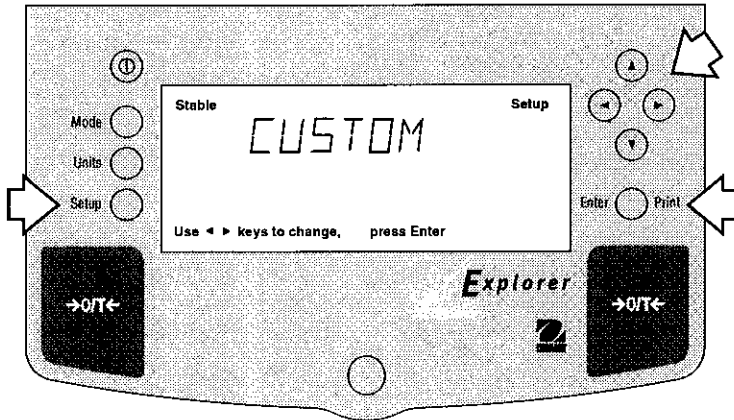

| SCIENTIFIC NOTATION | | | | |
|---------------------|---------------------------------|-------------|----------|--------------------|
| Conv. Factor | Number Between 0.1 and 1.999999 | Power of 10 | Mantissa | Exp. |
| 123.4 | = .1234 | x 1000 | = .1234 | x 10 ³ |
| 12.34 | = .1234 | x 100 | = .1234 | x 10 ² |
| 1.234 | = .1234 | x 10 | = .1234 | x 10 ¹ |
| .1234 | = .1234 | x 1 | = .1234 | x 10 ⁰ |
| .01234 | = .1234 | x .1 | = .1234 | x 10 ⁻¹ |
| .001234 | = .1234 | x .01 | = .1234 | x 10 ⁻² |
| .000123 | = .123 | x .001 | = .123 | x 10 ⁻³ |

| EXPONENTS | |
|-----------|--|
| E-3 | Moves decimal point 3 places to the left. |
| E-2 | Moves decimal point 2 places to the left. |
| E-1 | Moves decimal point 1 place to the left. |
| E0 | Leaves decimal point in normal position. |
| E1 | Moves decimal point 1 place to the right. |
| E2 | Moves decimal point 2 places to the right. |
| E3 | Moves decimal point 3 places to the right. |

Procedure



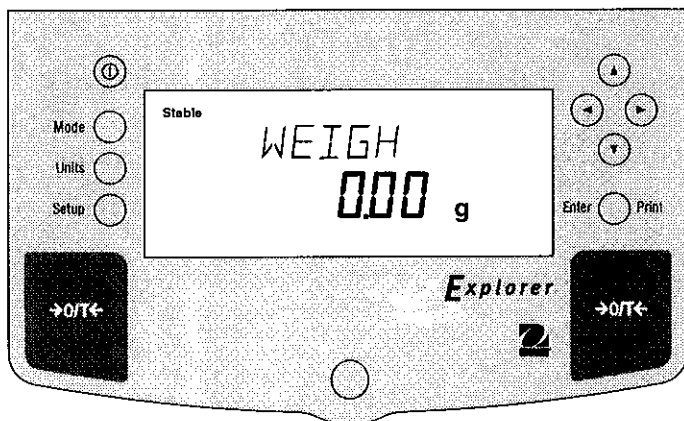
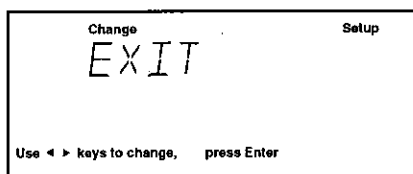
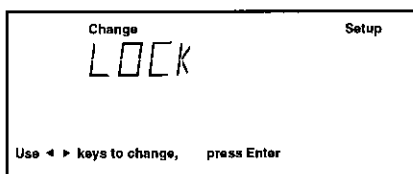
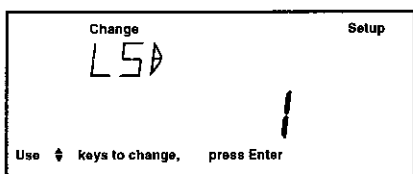
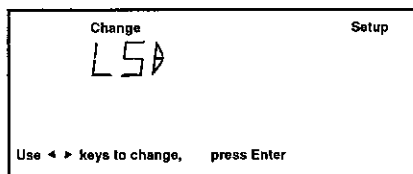

- Press the **Setup** button.
- Press \leftarrow or \rightarrow button until CUSTOM is displayed.
- Press **Enter** button to save setting, FACTOR is displayed.
- Press **Enter** button, The mantissa of the current conversion is displayed. The mantissa of the current conversion factor is displayed. This is a number between 0.1 and 1.999999 with the first digit flashing. For conversion factors outside of this range, the exponent will be used to move the decimal point.
- Press \leftarrow \rightarrow or \uparrow \downarrow buttons as directed by the display and enter a 7 digit number for the conversion factor.
- Press **Enter** button, EXP (exponent) is displayed.
- Press **Enter** button, 0 (exponent) is displayed.
- Press \uparrow or \downarrow button and select exponent value either -3, -2, -1, 0, 1, 2, or 3.

4.11 Custom Unit (Cont.)



| LSD's | |
|--------------|---|
| LSD .5 | Adds one decimal place display counts by 5's. |
| LSD 1 | Display counts by 1's. |
| LSD 2 | Display counts by 2's. |
| LSD 5 | Display counts by 5's. |
| LSD 10 | Display counts by 10's. |
| LSD 100 | Display counts by 100's. |

Procedure (Cont.)

- Press **Enter** button to save setting, LSD is displayed. There are 6 LSD (least significant digit) settings you can choose from (see table).
- Press **Enter** button, LSD 1 is displayed.
- Press  or  button and select LSD value either 1, 2, 5, 10 or 100.
- Press **Enter** button, SAVED is momentary displayed followed by LOCK.
- Press  or  button and select ON or OFF.
- Press **Enter** button, EXIT is displayed.
- Press **Enter** button to return to weighing mode.

4.12 Menu Lock-Out Protection

Access to the various menus can be disabled setting the Lockswitch located on the PC board inside the balance to OFF position. The Lockswitch locks out all menus which have had Lock turned ON. The default setting for the Lockswitch is OFF.

Type Approved/Legal for Trade Balance Sealing

All Explorer balances may be sealed for type approved/legal for trade applications. Type Approved balances include a lead seal with wire and security screw as shown in the figures.

For type approved balances consult local Weights and Measures officials to determine sealing method requirements.

After the balance has been set up properly and the menus are locked out, proceed to seal the balance.

Procedure

- Turn the display off and unplug the power cord.
- On balances with a draft shield, slide the door open and remove the pan and cover plate.
- On balances without a draft shield, remove the pan and cover plate. Higher capacity balances with a 6" or 8" pan do not have a cover plate.
- Remove the protective switch plate.
- The Lockswitch is located to the left of the pan support hole.
- Select the desired position on the Lockswitch and reassemble the balance.

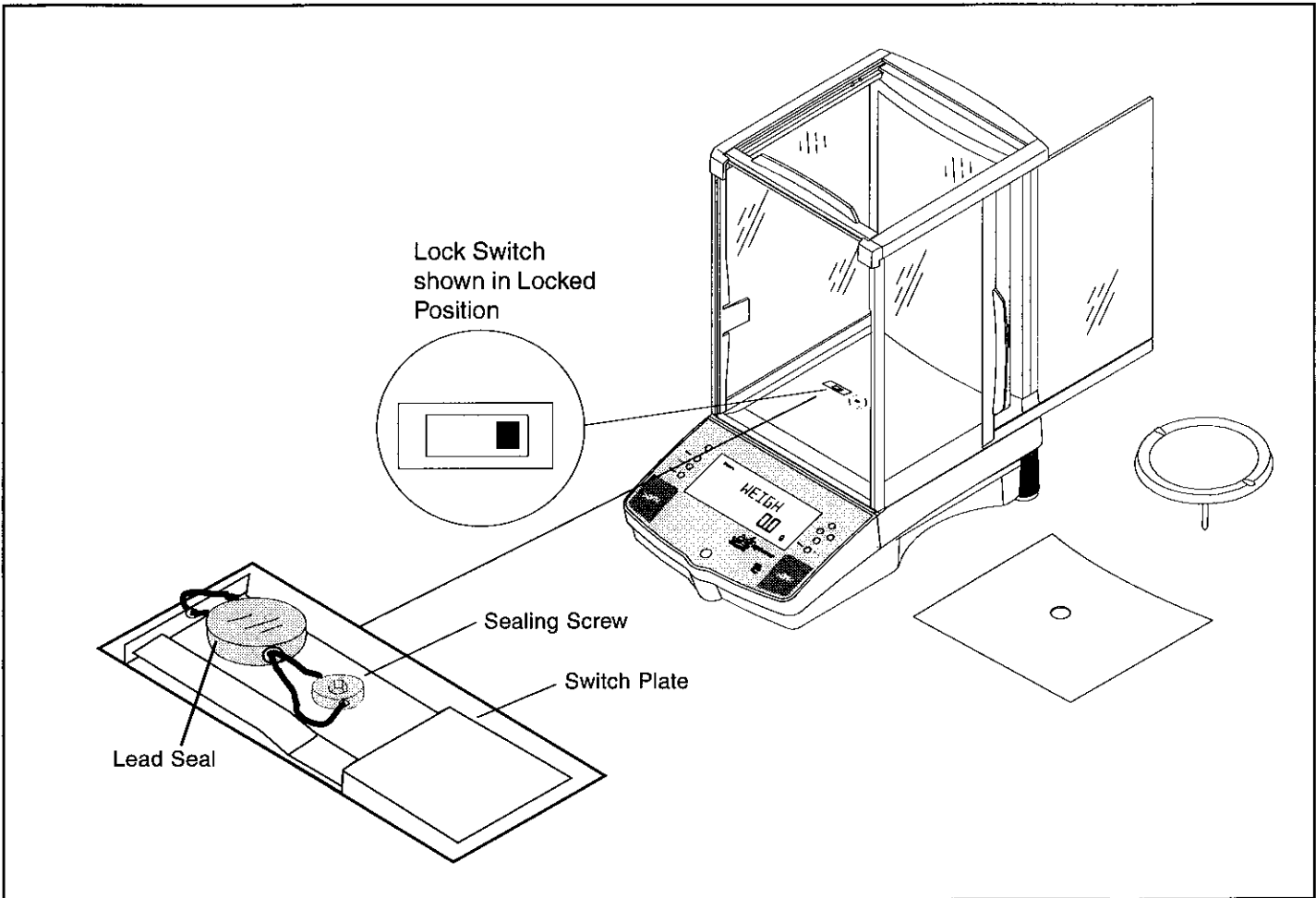

Example of Sealing Method

5 CARE AND MAINTENANCE

To keep the balance operating properly, the housing and platform should be kept clean and free from foreign material. If necessary, a cloth dampened with a mild detergent may be used. Keep calibration masses in a safe dry place.

5.1 Troubleshooting

| SYMPTOM | PROBABLE CAUSE(S) | REMEDY |
|--|---|--|
| Unit will not turn on. | Power cord not plugged in or properly connected to balance. | Check power cord connections. |
| Incorrect weight reading. | Balance was not re-zeroed before weighing. | Press →O/T← with no weight on the pan, then weigh item. |
| | Balance not properly calibrated. | Recalibrate correctly. |
| Cannot display weight in desired unit. | Desired unit not enabled. | Press Units button until desired measuring unit is shown. Enable units in Setup menu. |
| Unable to store menu settings/ changes. | Enter was not selected. | Press Enter when prompted. |
| | Menu locked. | Menu not locked properly. |
| RS232 interface not working. | Print menu settings not properly set up. | Verify interface settings in RS232 menu correspond to those of peripheral device. |
| | Cable connections. | Check cable connections. |
| Random segments displayed or display locks up. | Microprocessor locks up. | Turn power off, then turn on again. If condition persists, unit must be serviced. |
| Unable to change settings. | Menu locked (Lock switch set ON) | Set menu Lock OFF. Set Lock switch to OFF. |
| Unstable readings. | Excessive air currents. | Check environmental conditions. |
| | Vibration on table surface. | Place balance on a stable surface or change averaging level. |
| Error message display. | _____ | See Error Codes list. |
| Cannot access weighing mode. | Desired weighing mode is not enabled. | Press mode until desired weighing mode is displayed. Enable weighing mode. |

5.2 RS232 Interface

Explorer balances are equipped with a bi-directional RS232 compatible interface for communication with printers and computers. When the balance is connected directly to a printer, displayed data can be output at any time by simply pressing PRINT, or by using the Auto Print feature.

Connecting the balance to a computer enables you to operate the balance from the computer, as well as receive data such as displayed weight, weighing mode, stability status, etc.

The following sections describe the hardware and software provided with the balance

Hardware

On the rear of the balance, the right-hand, 9-pin male subminiature "D" connector is provided for interfacing to other devices. The pinout and pin connections are shown in the adjacent illustration.

The balance will not output any data unless pin 5 (CTS) is held in an ON state (+3 to +15 V dc). Interfaces not utilizing the CTS handshake may tie pin 5 to pin 6 to defeat it.

Output Formats

Data output can be initiated in one of three ways: 1) By pressing PRINT; 2) Using the Auto Print feature; 3) Sending a print command ("P") from a computer.

The output format is illustrated in the RS232 command table which follows.

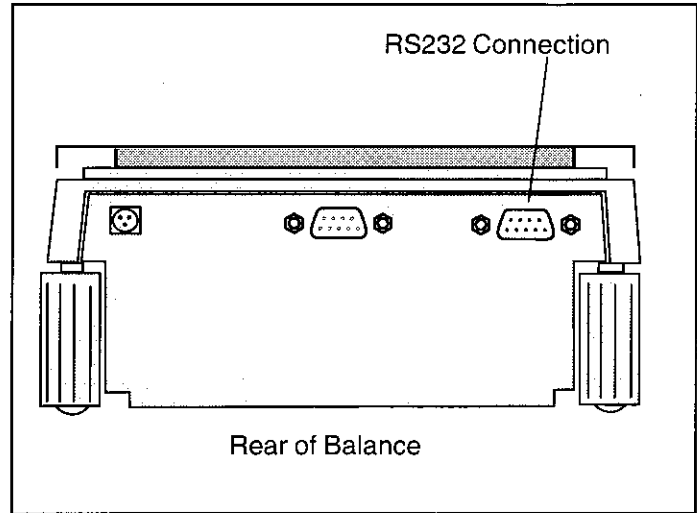

RS232 Commands

All communication is accomplished using standard ASCII format. Characters shown in the following table are acknowledged by the balance. Invalid command response "ES" error indicates the balance has not recognized the command. Commands sent to the balance must be terminated with a carriage return (CR) or carriage return-line line feed (CRLF). For example, a tare command should appear as shown in the adjacent diagram. Data output by the balance is always terminated with a carriage return - line feed (CRLF).

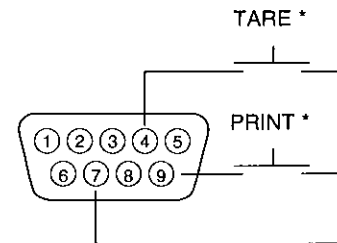

RS232 COMMANDTABLE

| Command Character | Description | | | | | | | | | | | | | | | | | | | | | | | | | | | | | | | |
|-------------------|--|---------|-------------------|---------|---------------------|---------|----------------------|---------------|--------------------------|---|---|----|----|---|---|------|-------|----|------|-------|-----|------|-----|----|-------|---|----|----|--|------|--|--|
| ? | Print current mode | | | | | | | | | | | | | | | | | | | | | | | | | | | | | | | |
| | <table border="1"> <tr> <td>Field:</td> <td>Mode</td> <td>Stab</td> <td>CR</td> <td>LF</td> </tr> <tr> <td>Length:</td> <td>5</td> <td>1</td> <td>1</td> <td>1</td> </tr> </table> <p>blank if stable " ? " if unstable</p> <table border="1"> <tr> <td>mg</td> <td>GN</td> <td>N</td> </tr> <tr> <td>g</td> <td>tael</td> <td>tical</td> </tr> <tr> <td>kg</td> <td>tael</td> <td>custm</td> </tr> <tr> <td>dwt</td> <td>tael</td> <td>Pcs</td> </tr> <tr> <td>ct</td> <td>momme</td> <td>%</td> </tr> <tr> <td>oz</td> <td>lb</td> <td></td> </tr> <tr> <td>oz t</td> <td></td> <td></td> </tr> </table> | Field: | Mode | Stab | CR | LF | Length: | 5 | 1 | 1 | 1 | mg | GN | N | g | tael | tical | kg | tael | custm | dwt | tael | Pcs | ct | momme | % | oz | lb | | oz t | | |
| Field: | Mode | Stab | CR | LF | | | | | | | | | | | | | | | | | | | | | | | | | | | | |
| Length: | 5 | 1 | 1 | 1 | | | | | | | | | | | | | | | | | | | | | | | | | | | | |
| mg | GN | N | | | | | | | | | | | | | | | | | | | | | | | | | | | | | | |
| g | tael | tical | | | | | | | | | | | | | | | | | | | | | | | | | | | | | | |
| kg | tael | custm | | | | | | | | | | | | | | | | | | | | | | | | | | | | | | |
| dwt | tael | Pcs | | | | | | | | | | | | | | | | | | | | | | | | | | | | | | |
| ct | momme | % | | | | | | | | | | | | | | | | | | | | | | | | | | | | | | |
| oz | lb | | | | | | | | | | | | | | | | | | | | | | | | | | | | | | | |
| oz t | | | | | | | | | | | | | | | | | | | | | | | | | | | | | | | | |
| nnnA | Set Auto Print feature to "nnn" (see table). | | | | | | | | | | | | | | | | | | | | | | | | | | | | | | | |
| | <table border="1"> <tr> <td>nnn = 0</td> <td>Turns feature OFF</td> </tr> <tr> <td>nnn = S</td> <td>Output on stability</td> </tr> <tr> <td>nnn = C</td> <td>Output is continuous</td> </tr> <tr> <td>nnnn = 1-3600</td> <td>Sets Auto Print Interval</td> </tr> </table> | nnn = 0 | Turns feature OFF | nnn = S | Output on stability | nnn = C | Output is continuous | nnnn = 1-3600 | Sets Auto Print Interval | | | | | | | | | | | | | | | | | | | | | | | |
| nnn = 0 | Turns feature OFF | | | | | | | | | | | | | | | | | | | | | | | | | | | | | | | |
| nnn = S | Output on stability | | | | | | | | | | | | | | | | | | | | | | | | | | | | | | | |
| nnn = C | Output is continuous | | | | | | | | | | | | | | | | | | | | | | | | | | | | | | | |
| nnnn = 1-3600 | Sets Auto Print Interval | | | | | | | | | | | | | | | | | | | | | | | | | | | | | | | |

- 1 N/C
- 2 Data Out (TXD)
- 3 Data In (RXD)
- 4* Tare (External signal)
- 5 Clear To Send (CTS)
- 6 Data Terminal Ready (DTR)
- 7 Ground
- 8 Request To Send (RTS)
- 9* Print (External signal)

* External PRINT and/or TARE switches may be installed as shown in the diagram. Momentary contact switches must be used.

RS232 COMMAND TABLE (Cont.)

| Command Character | Description | | | | | | | | | | | | | | | | | | | | | | | | | | | | | | | | | | | | | | | | | | | | | | | | | | | |
|-------------------|--|-----------------|---|---------------|---|---|-------|---|---|------------|---|---|---------------|---|---|--------|---|---|--------|---|---|-------------|---|---|--------|---|---|-----------------|----|---|-----------------|----|---|--------------|----|---|--------|----|---|----------------|----|---|------------|----|---|----------|----|---|-------|----|---|--------------|
| C | Begin span calibration | | | | | | | | | | | | | | | | | | | | | | | | | | | | | | | | | | | | | | | | | | | | | | | | | | | |
| xD | Set 1 second print delay (set x = 0 for OFF, or x = 1 for ON) | | | | | | | | | | | | | | | | | | | | | | | | | | | | | | | | | | | | | | | | | | | | | | | | | | | |
| F | Print current function. | | | | | | | | | | | | | | | | | | | | | | | | | | | | | | | | | | | | | | | | | | | | | | | | | | | |
| xI | Set Averaging Filter Level to "x", where x = 0 to 3 (see table). If LFT, level 0 to 1. <table border="1" style="float: right; margin-left: 20px;"> <tr><td>0</td><td>=</td><td>minimum level</td></tr> <tr><td>1</td><td>=</td><td></td></tr> <tr><td>2</td><td>=</td><td></td></tr> <tr><td>3</td><td>=</td><td>maximum level</td></tr> </table> | 0 | = | minimum level | 1 | = | | 2 | = | | 3 | = | maximum level | | | | | | | | | | | | | | | | | | | | | | | | | | | | | | | | | | | | | | | |
| 0 | = | minimum level | | | | | | | | | | | | | | | | | | | | | | | | | | | | | | | | | | | | | | | | | | | | | | | | | | |
| 1 | = | | | | | | | | | | | | | | | | | | | | | | | | | | | | | | | | | | | | | | | | | | | | | | | | | | | |
| 2 | = | | | | | | | | | | | | | | | | | | | | | | | | | | | | | | | | | | | | | | | | | | | | | | | | | | | |
| 3 | = | maximum level | | | | | | | | | | | | | | | | | | | | | | | | | | | | | | | | | | | | | | | | | | | | | | | | | | |
| L | Begin linearity calibration | | | | | | | | | | | | | | | | | | | | | | | | | | | | | | | | | | | | | | | | | | | | | | | | | | | |
| xM | Places balance in mode "x", where x = 1 to 17 (see table). If unit or mode is not already enabled, command will be ignored. <table border="1" style="float: right; margin-left: 20px;"> <tr><td>1</td><td>=</td><td>milligrams</td></tr> <tr><td>2</td><td>=</td><td>grams</td></tr> <tr><td>3</td><td>=</td><td>kilo grams</td></tr> <tr><td>4</td><td>=</td><td>dwt</td></tr> <tr><td>5</td><td>=</td><td>Carats</td></tr> <tr><td>6</td><td>=</td><td>Ounces</td></tr> <tr><td>7</td><td>=</td><td>Ounces troy</td></tr> <tr><td>8</td><td>=</td><td>Grains</td></tr> <tr><td>9</td><td>=</td><td>Taels Hong Kong</td></tr> <tr><td>10</td><td>=</td><td>Taels Singapore</td></tr> <tr><td>11</td><td>=</td><td>Taels Taiwan</td></tr> <tr><td>12</td><td>=</td><td>Mommes</td></tr> <tr><td>13</td><td>=</td><td>Decimal Pounds</td></tr> <tr><td>14</td><td>=</td><td>(Not used)</td></tr> <tr><td>15</td><td>=</td><td>Newton's</td></tr> <tr><td>16</td><td>=</td><td>tical</td></tr> <tr><td>17</td><td>=</td><td>Custom Units</td></tr> </table> | 1 | = | milligrams | 2 | = | grams | 3 | = | kilo grams | 4 | = | dwt | 5 | = | Carats | 6 | = | Ounces | 7 | = | Ounces troy | 8 | = | Grains | 9 | = | Taels Hong Kong | 10 | = | Taels Singapore | 11 | = | Taels Taiwan | 12 | = | Mommes | 13 | = | Decimal Pounds | 14 | = | (Not used) | 15 | = | Newton's | 16 | = | tical | 17 | = | Custom Units |
| 1 | = | milligrams | | | | | | | | | | | | | | | | | | | | | | | | | | | | | | | | | | | | | | | | | | | | | | | | | | |
| 2 | = | grams | | | | | | | | | | | | | | | | | | | | | | | | | | | | | | | | | | | | | | | | | | | | | | | | | | |
| 3 | = | kilo grams | | | | | | | | | | | | | | | | | | | | | | | | | | | | | | | | | | | | | | | | | | | | | | | | | | |
| 4 | = | dwt | | | | | | | | | | | | | | | | | | | | | | | | | | | | | | | | | | | | | | | | | | | | | | | | | | |
| 5 | = | Carats | | | | | | | | | | | | | | | | | | | | | | | | | | | | | | | | | | | | | | | | | | | | | | | | | | |
| 6 | = | Ounces | | | | | | | | | | | | | | | | | | | | | | | | | | | | | | | | | | | | | | | | | | | | | | | | | | |
| 7 | = | Ounces troy | | | | | | | | | | | | | | | | | | | | | | | | | | | | | | | | | | | | | | | | | | | | | | | | | | |
| 8 | = | Grains | | | | | | | | | | | | | | | | | | | | | | | | | | | | | | | | | | | | | | | | | | | | | | | | | | |
| 9 | = | Taels Hong Kong | | | | | | | | | | | | | | | | | | | | | | | | | | | | | | | | | | | | | | | | | | | | | | | | | | |
| 10 | = | Taels Singapore | | | | | | | | | | | | | | | | | | | | | | | | | | | | | | | | | | | | | | | | | | | | | | | | | | |
| 11 | = | Taels Taiwan | | | | | | | | | | | | | | | | | | | | | | | | | | | | | | | | | | | | | | | | | | | | | | | | | | |
| 12 | = | Mommes | | | | | | | | | | | | | | | | | | | | | | | | | | | | | | | | | | | | | | | | | | | | | | | | | | |
| 13 | = | Decimal Pounds | | | | | | | | | | | | | | | | | | | | | | | | | | | | | | | | | | | | | | | | | | | | | | | | | | |
| 14 | = | (Not used) | | | | | | | | | | | | | | | | | | | | | | | | | | | | | | | | | | | | | | | | | | | | | | | | | | |
| 15 | = | Newton's | | | | | | | | | | | | | | | | | | | | | | | | | | | | | | | | | | | | | | | | | | | | | | | | | | |
| 16 | = | tical | | | | | | | | | | | | | | | | | | | | | | | | | | | | | | | | | | | | | | | | | | | | | | | | | | |
| 17 | = | Custom Units | | | | | | | | | | | | | | | | | | | | | | | | | | | | | | | | | | | | | | | | | | | | | | | | | | |
| P | Print display data | | | | | | | | | | | | | | | | | | | | | | | | | | | | | | | | | | | | | | | | | | | | | | | | | | | |
| xSL | Set stable data only printing (set x = 0 to 3). If LFT 0 or 1. | | | | | | | | | | | | | | | | | | | | | | | | | | | | | | | | | | | | | | | | | | | | | | | | | | | |
| T | Same effect as pressing O/T button. | | | | | | | | | | | | | | | | | | | | | | | | | | | | | | | | | | | | | | | | | | | | | | | | | | | |
| V | Print EPROM version | | | | | | | | | | | | | | | | | | | | | | | | | | | | | | | | | | | | | | | | | | | | | | | | | | | |
| Esc V | Print balance ID (13 characters). | | | | | | | | | | | | | | | | | | | | | | | | | | | | | | | | | | | | | | | | | | | | | | | | | | | |
| xZ | Set Auto Zero to "x", where x = 0 to 3. 0=Off, 1=0.5d, 2=1d, 3=5d. If LFT, programs Auto zero level from 0 to 1. | | | | | | | | | | | | | | | | | | | | | | | | | | | | | | | | | | | | | | | | | | | | | | | | | | | |
| x% | Set % reference function. Uses x (Real Number) as current Percent Reference. Reference weigh must be entered in grams. | | | | | | | | | | | | | | | | | | | | | | | | | | | | | | | | | | | | | | | | | | | | | | | | | | | |
| x# | Set PC reference function. Uses x (Real Number) as current Percent Reference. Reference weigh must be entered in grams. | | | | | | | | | | | | | | | | | | | | | | | | | | | | | | | | | | | | | | | | | | | | | | | | | | | |
| Esc R | Resets Setup and Print menus to factory defaults. CAUTION: This will reset RS232 configuration. | | | | | | | | | | | | | | | | | | | | | | | | | | | | | | | | | | | | | | | | | | | | | | | | | | | |
| ON | Turns balance on. | | | | | | | | | | | | | | | | | | | | | | | | | | | | | | | | | | | | | | | | | | | | | | | | | | | |
| OFF | Turns balance off. | | | | | | | | | | | | | | | | | | | | | | | | | | | | | | | | | | | | | | | | | | | | | | | | | | | |

RS232 COMMAND TABLE (Cont.)

| Command Character | Description |
|--------------------------|---|
| # | Print current Parts Count Reference Weigh. |
| % | Print current Percent Reference Weigh. |
| xF | Set current function, set x for 0=None (normal weigh), 1=percent, 2=parts Counting, 3=Animal Weighing. None |
| xAW | Set Animal Level from 0 to 3. 0= least amount of filtering. |
| xE | Set/Reset Auto Restart in Animal mode. Where x is 0=Off and 1=ON. |
| E | Start Animal cycle. |
| xT | Download tare, tare weight must be entered in grams. |
| ID | Print Current User ID String. |
| xID | Program User ID String, 1-8 characters. |
| AC | Abort Calibration. |
| xUC | User Weight Calibration. |
| IC | Internal calibration (InCAL™) |
| LE | Show Last Error Code. Response: Err: Error Number. |
| SN | Show Serial Number. |
| xS | Print Stable Only. Where x =0 Off and x=1 On. |
| TIME | Print Current Time. Note, a ? mark will follow if date or time has not been set. |
| mm/dd/yy SETDATE | Set Date Command and remove Invalid Indicator |
| hh:mm:ss SETTIME | Set Time Command and Remove Invalid Time Indicator |
| DATE | Prints Current Date. Note, a ? mark will follow the year if date or time has not been set. |
| WSTM | Write Clock Trim Value. The clock can be adjusted by + - 60 seconds a month. |
| RSTM | Read Clock Trim value |
| SETUP | Program Setup menu Options |
| SW | Show Lockswitch status. |

5.3 Error Codes List

Error Codes List

The following list describes the various error codes and which can appear on the display and the suggested remedy.

Data Errors

- 1.0 Transient error (hardware error, probably static discharge). If error persists, the balance must be serviced.
- 1.1 Balance temperature transducer hardware error.

Tare Errors

- 2.0 Balance is unable to stabilize within time limit after taring. Environment is too hostile or balance needs recalibration.

Calibration Errors

- 3.0 Incorrect or no calibration mass used for calibration. Recalibrate with correct masses.

RS232 Errors

- 4.4 RS232 buffer is full.

User Errors

- 7.0 User entry out of bounds.
- 7.2 Number outside of display capacity.

Over-Under Load Errors

- 8.0 Hardware error causing an internal weight signal which is too low. Check if pan is off. If not, the balance must be serviced.
- 8.1 Hardware error caused by an internal weight signal which is too high. Check load on the pan which may be excessive. If error persists, the balance must be serviced.
- 8.2 Power-on load out of specification (LFT only)
- 8.3 Rated capacity exceeded. Remove excessive weight from pan.
- 8.4 Underload condition on balance. Check that the proper pan is installed.
- 8.5 Internal calibration weight internal sensor indicated its weight on the pan.

Checksum Errors

- 9.1 Bad factory checksum. If error persists, have the balance serviced.
- 9.2 Bad factory checksum. If error persists, have the balance serviced.
- 9.3 Bad factory checksum. If error persists, have the balance serviced.
- 9.4 Factory internal calibration data failed checksum. This failure will disable access to the InCAL™ feature (if installed).
- 9.5 Factory calibration data failed checksum.
- 9.8 User calibration data failed checksum.
- 9.9 Factory temperature compensation data failed checksum.

5.4 Information Messages

- CAL NOW** If InCAL™ (internal calibration) is installed. Message to recalibrate the balance. The message will remain until calibrated.
- WARM UP** The user tried to perform an internal calibration and this message will be flashed in the 14 segment field. The balance requires a 7 minute warmup period. During warmup the user can not select InCAL™ from the menu.
- SAVED** This message is flashed when an item is changed in the menu and the new value is written to the EEPROM.
- LOCKED** This message is flashed when an item can not be changed in the menu because the menu is locked and the Lock Switch is set locked.
- LOW REF** The message is flashed in parts counting or percent when the calculated reference weight is very low.
- UNSTBLE** This message is flashed when the balance was unable to acquire stable data during internal calibration.

5.5 Service Information

If the Troubleshooting section does not resolve or describe your problem, you will need to contact an authorized Ohaus Service Agent. For Service assistance in the United States, please call Aftermarket, Ohaus Corporation toll-free at (800) 526-0659. An Ohaus Product Service Specialist will be available to help you.

5.6 Replacement parts

| <u>Description</u> | <u>Ohaus Part No.</u> |
|---|-----------------------|
| Power Pack, 100/120 V ac US Plug (Cord set part of power pack) | 490202-01 |
| Power Pack, (Cord set required for UK, European and Australian) | 490203-01 |
| Cord Set, 230 V ac, UK Plug | 76448-00 |
| Cord Set, 230 V ac, European Plug | 76212-00 |
| Cord Set, 230 V ac, Australian plug | 76199-01 |

5.7 Accessories

| <u>Description</u> | <u>Ohaus Part No.</u> |
|--------------------|-----------------------|
|--------------------|-----------------------|

Calibration Masses - ASTM Class 1 Tolerance:

| | |
|--|------------|
| 20 g | 49024-11 |
| 50 g | 49054-11 |
| 100 g | 49015-11 |
| 200 g | 49025-11 |
| 500 g | 49055-11 |
| 1 kg | 49016-11 |
| 2 kg | 49026-11 |
| 4 kg | 49046-11 |
| In-Use Display Cover Kit | 470003-010 |
| Security Device | 470004-010 |
| Draftshield Kit | 470006-010 |
| Density Determination Kit | 470007-010 |
| Modular Display Upgrade Kit | 470008-010 |
| Auxilliary Display Kit | |
| (Table Mount) | 470009-010 |
| (Wall Mount) | 470009-020 |
| (Tower Mount) | 470009-030 |
| Remote Display Kit | |
| (Table Mount) | 470010-010 |
| (Wall Mount) | 470010-020 |
| (Tower Mount) | 470010-030 |
| RS232 Interface Cable, Blunt end (user defined) | AS017-01 |
| RS232 Interface Cable, IBM® PC 25 Pin | AS017-02 |
| RS232 Interface Cable, (connects impact printer) | AS017-06 |
| RS232 Interface Cable, IBM® PC 9 Pin | AS017-09 |
| RS232 Interface Cable, Apple® IIGS/Macintosh | AS017-10 |
| Printer | AS142 |

5.8 Specifications

Analyticals

| | | | | | |
|--|---|-----|-----|-----|-----------|
| Capacity (g) | 62 | 110 | 162 | 210 | 100/210 * |
| Readability (mg) | 0.1 | | | | 0.1/1 |
| Weighing modes | g, mg, μ z, oz t, ct, dwt, taels (3), mommes, gn, ti, N, custom unit | | | | |
| Functions | Parts counting, animal weighing, percent | | | | |
| Options | GLP, time, date, lockswitch, LFT (U.S.)/type approved | | | | |
| Repeatability (Std. dev.) (mg) | 0.1 | | | | 0.1/0.5 |
| Linearity (mg) (\pm) | 0.2 | | | | 0.2/0.5 |
| Tare range | Full capacity by subtraction | | | | |
| Safe overload capacity | 150% of capacity | | | | |
| Stabilization time | \leq 4 seconds | | | | |
| Sensitivity drift PPM/ $^{\circ}$ C (10 $^{\circ}$ C - 30 $^{\circ}$ C) | 3 | | | | |
| Operating temperature range: w/internal calibration | 10 $^{\circ}$ to 40 $^{\circ}$ C/ 50 $^{\circ}$ to 104 $^{\circ}$ F | | | | |
| w/o internal calibration | 10 $^{\circ}$ to 30 $^{\circ}$ C/50 $^{\circ}$ to 86 $^{\circ}$ F | | | | |
| Calibration | InCAL™ calibration | | | | |
| Power requirements | External Adapter, 100 -120 V ac, 220 - 240 V ac, 50/60 Hz Plug configuration for US, Euro, UK, Japan & Australia | | | | |
| Draft shield (in/cm) (free height above platform) | 10.2/25.9 | | | | |
| Display (in/cm) | 0.6/1.5 | | | | |
| Pan size (in/cm) | 3.5/9. diameter | | | | |
| Dimensions (WxHxD) (in/cm) | 9 x 15.25 x14/22.8 x 38.7 x 35.5 | | | | |

Precision Top Loaders

| | | | | | | | | | | | | |
|--|---|-----|--------------|-----|------------------------------------|----------------------------------|------|------------|--------------------|------|------|--|
| Capacity (g) | 210 | 410 | 100/410* | 610 | 1550 | 2100 | 4100 | 1000/4100* | 4100 | 6100 | 8100 | |
| Readability (g) | 0.001 | | 0.001/0.01 | | 0.01 | | | 0.01/0.1 | | 0.1 | | |
| Weighing modes | g, mg, kg, lbs, oz, oz t, ct, dwt, taels (3), mommes, gn, ti, N, custom unit | | | | | | | | | | | |
| Functions | Parts counting, animal weighing, percent | | | | | | | | | | | |
| Options | GLP, time, date, lockswitch, LFT (U.S.)/type approved | | | | | | | | | | | |
| Repeatability (Std. dev.) (g) | 0.0005 | | 0.0005/0.005 | | 0.005 | | | 0.01/0.05 | | 0.05 | | |
| Linearity (g) (\pm) | 0.002 | | 0.002/0.005 | | 0.02 | | | 0.02/0.05 | | 0.1 | | |
| Tare range | Full capacity by subtraction | | | | | | | | | | | |
| Stabilization time | \leq 3 seconds | | | | | | | | | | | |
| Sensitivity drift PPM/ $^{\circ}$ C (10 $^{\circ}$ C - 30 $^{\circ}$ C) | 4 | 3 | 4 | 3 | 5 | 4 | 3 | 4 | | 3 | | |
| Operating temperature range: w/internal calibration | 10 $^{\circ}$ to 40 $^{\circ}$ C/50 $^{\circ}$ to 104 $^{\circ}$ F | | | | | | | | | | | |
| w/o internal calibration | 10 $^{\circ}$ to 30 $^{\circ}$ C/50 $^{\circ}$ to 86 $^{\circ}$ F | | | | | | | | | | | |
| Calibration | InCAL™ calibration | | | | | | | | | | | |
| Power requirements | External Adapter, 100 -120 V ac, 220 - 240 V ac, 50/60 Hz Plug configuration for US, Euro, UK, Japan & Australia | | | | | | | | | | | |
| Draft shield (in/cm) (free height above platform) | 10.2/25.9 | | | | | | | | | | | |
| Display (in/cm) | 0.6/1.5 | | | | | | | | | | | |
| Pan size (in/cm) | 4.7/12 Dia. | | | | 6.8 x 6.8/17.2 x 17.2 w/windshield | | | | 8 x 8/ 20.3 x 20.3 | | | |
| Dimensions (WxHxD) (in/cm) | 9 x 15.25 x14/22.8 x 38.7 x 35.5 | | | | | 8.25 x 4 x 14/20.9 x 10.1 x 35.5 | | | | | | |

* Moveable FineRange™

NOTE: Not all weighing modes apply depending upon capacity and resolution of the balance.

LIMITED WARRANTY

Ohaus products are warranted against defects in materials and workmanship from the date of delivery through the duration of the warranty period. During the warranty period Ohaus will repair, or, at its option, replace any component(s) that proves to be defective at no charge, provided that the product is returned, freight prepaid, to Ohaus.

This warranty does not apply if the product has been damaged by accident or misuse, exposed to radioactive or corrosive materials, has foreign material penetrating to the inside of the product, or as a result of service or modification by other than Ohaus. In lieu of a properly returned warranty registration card, the warranty period shall begin on the date of shipment to the authorized dealer. No other express or implied warranty is given by Ohaus Corporation. Ohaus Corporation shall not be liable for any consequential damages.

As warranty legislation differs from state to state and country to country, please contact Ohaus or your local Ohaus dealer for further details.



Ohaus Corporation
29 Hanover Road,
Florham Park, NJ 07932, USA
Tel: (201) 377-9000,
Fax: (201) 593-0359

Ohaus Europe Ltd.
ENGLAND
Tel: +44 (0) 1954 251343,
Fax: +44 (0) 1954 250205

With offices in Germany, France, Spain, Italy, Canada, Mexico and Japan.



INSTRUCTION MANUAL

Explorer Balances

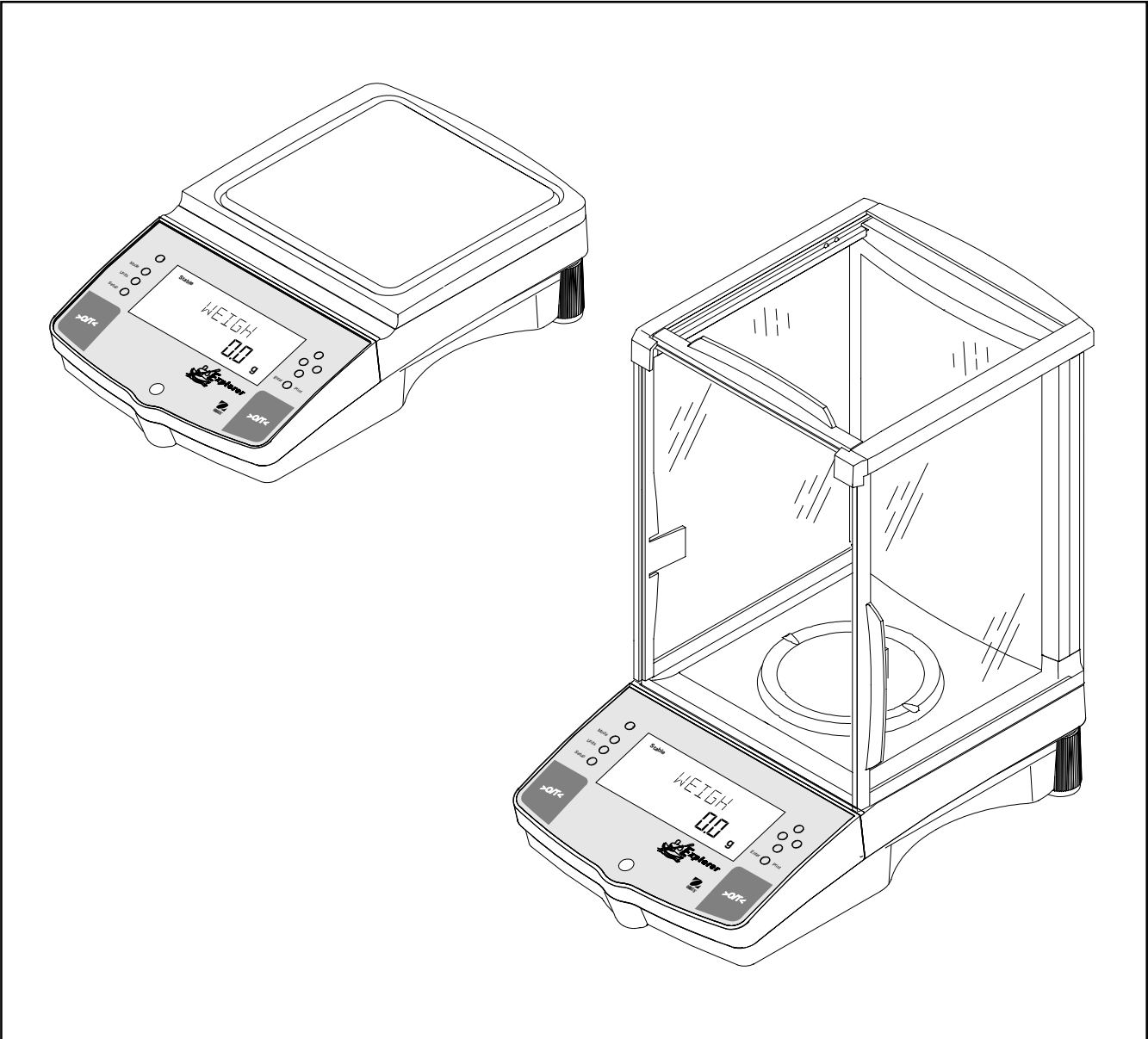

FCC NOTE: THIS EQUIPMENT HAS BEEN TESTED AND FOUND TO COMPLY WITH THE LIMITS FOR A CLASS A DIGITAL DEVICE, PURSUANT TO PART 15 OF THE FCC RULES.

THESE LIMITS ARE DESIGNED TO PROVIDE REASONABLE PROTECTION AGAINST HARMFUL INTERFERENCE WHEN THE EQUIPMENT IS OPERATED IN A COMMERCIAL ENVIRONMENT. THIS EQUIPMENT GENERATES, USES, AND CAN RADIATE RADIO FREQUENCY ENERGY AND, IF NOT INSTALLED AND USED IN ACCORDANCE WITH THE INSTRUCTION MANUAL, MAY CAUSE HARMFUL INTERFERENCE TO RADIO COMMUNICATIONS. OPERATION OF THIS EQUIPMENT IN A RESIDENTIAL AREA IS LIKELY TO CAUSE HARMFUL INTERFERENCE IN WHICH CASE THE USER WILL BE REQUIRED TO CORRECT THE INTERFERENCE AT HIS OWN EXPENSE.

THIS DIGITAL APPARATUS DOES NOT EXCEED THE CLASS A LIMITS FOR RADIO NOISE EMISSIONS FROM DIGITAL APPARATUS AS SET OUT IN THE INTERFERENCE-CAUSING EQUIPMENT STANDARD ENTITLED "DIGITAL APPARATUS", ICES-003 OF THE DEPARTMENT OF COMMUNICATIONS CANADA.

CET APPAREIL NUMERIQUE RESPECTE LES LIMITES DE BRUITS RADIOELECTRIQUES APPLICABLES AUX APPAREILS NUMERIQUES DE CLASSE A PRESCRITES DANS LA NORME SUR LE MATERIEL BROUILLEUR: "APPAREILS NUMERIQUES", NMB-003 EDICTEE PAR LE MINISTRE DES

Unauthorized changes or modifications to this equipment are not permitted.

EC - DECLARATION OF CONFORMITY

Explorer

| | | | | | |
|--------|--------|--------|--------|--------|--------|
| E10640 | E00640 | E10645 | E00645 | | |
| E11140 | E01140 | E11145 | E01145 | | |
| E12140 | E02140 | E12145 | E02145 | | |
| E1RR80 | E0RR80 | E1RR85 | E0RR85 | | |
| E12130 | E02130 | E12132 | E02132 | E12135 | E02135 |
| E14130 | E04130 | E14132 | E04132 | E14135 | E04135 |
| E1RV70 | E0RV70 | E1RV72 | E0RV72 | E1RV75 | E0RV75 |
| E16120 | E06120 | E16122 | E06122 | E16125 | E06125 |
| E1B120 | E0B120 | E1B122 | E0B122 | E1B125 | E0B125 |
| E1D120 | E0D120 | E1D122 | E0D122 | E1D125 | E0D125 |
| E1RW60 | E0RW60 | E1RW62 | E0RW62 | E1RW65 | E0RW65 |
| E1D110 | E0D110 | E1D112 | E0D112 | E1D115 | E0D115 |
| E1F110 | E0F110 | E1F112 | E0F112 | E1F115 | E0F115 |
| E1H110 | E0H110 | E1H112 | E0H112 | E1H115 | E0H115 |
| E01640 | E0A520 | E0E122 | E15132 | E05132 | E15135 |
| E16130 | E06130 | E16135 | | | |
| E1F120 | E0F120 | E1F122 | E0F122 | E1F125 | |

Voyager

| | | | | | |
|--------|--------|--------|--------|--------|--|
| V10640 | V00640 | V10645 | | | |
| V11140 | V01140 | V11145 | | | |
| V12140 | V02140 | V12145 | | | |
| V1RR80 | V0RR80 | V1RR85 | | | |
| V12130 | V02130 | V12132 | V02132 | V12135 | |
| V14130 | V04130 | V14132 | V04132 | V14135 | |
| V1RV70 | V0RV70 | V1RV72 | V0RV72 | V1RV75 | |
| V16120 | V06120 | V16122 | V06122 | V16125 | |
| V1B120 | V0B120 | V1B122 | V0B122 | V1B125 | |
| V1D120 | V0D120 | V1D122 | V0D122 | V1D125 | |
| V1RW60 | V0RW60 | V1RW62 | V0RW62 | V1RW65 | |
| V1D110 | V0D110 | V1D112 | V0D112 | V1D115 | |
| V1F110 | V0F110 | V1F112 | V0F112 | V1F115 | |
| V1H110 | V0H110 | V1H112 | V0H112 | V1H115 | |
| V16130 | V06130 | V16135 | | | |
| V1F120 | V0F120 | V1F122 | V0F122 | V1F125 | |

New Jersey, 07058, USA
22, Jun. 01







James Ohaus
President

Ohaus Corporation, Pine Brook, NJ

Declaration of Conformity We, Ohaus Corporation, declare under our sole responsibility that the balance models listed below marked with "CE" - are in conformity with the directives and standards mentioned.

Balance model (s) **Explorer/Voyager**

| Marked with: | EC Directive (Including applicable amendments) | Standard |
|--|---|--|
|  Year of attachment of the CE mark: 96 | 73/23/EC Electrical equipment for use within specified voltage limits | IEC 1010 -1:1990 + A1: 92 + A2: 95 Safety requirements for Electrical Equipment for Measurement, Control Laboratory Use, Part 1: General Requirements |
| | 89/336/EC Electromagnetic compatibility | EN61326: -1:1997 (class B) + A1: 1998 EMC Emissions, residential, commercial and light industry. EN61326: -1:1997 A1:1998 (industrial requirements) EMC Immunity. EN61000-3-2:1995 + A1:1998 + A2: 1998; EN61000-3-3:1995 EMC Part 3 (for equipment rated input current < or=16A) Limits- Section 2: Limits for harmonic current emissions Limits- section 3: Limitation of voltage fluctuations and flicker in low voltage supply systems |
|  | | EN45501:1992 Non Automatic Weighing Instruments |
| Additional Standards | | |
|  | CAN/CSA-C22.2 No. 1010.1-92; UL Std. No. 3101-1 Safety requirements for Electrical Equip. for measurement, Control and Laboratory Use, Part 1; General Requirements | |
| FCC  | FCC, Part 15, class A Emission | |
| | AS/NZS4251.1 AS/NZS4252.1 Emission and Immunity | |

ISO 9001 Registration for Ohaus Corporation. Ohaus Corporation, USA, was examined and evaluated in 1994 by the Bureau Veritas Quality International, BVQI, and was awarded ISO 9001 registration. This certifies that Ohaus Corporation, USA, has a quality system that conforms with the international standards for quality management and quality assurance (ISO 9000 series). Repeat audits are carried out by BVQI at intervals to check that the quality system is operated in the proper manner.

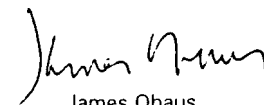
 James Ohaus
 President

Ohaus Corporation, Pine Brook, NJ

TABLE OF CONTENTS

| | | |
|-----------|---|-----------|
| | OVERVIEW OF CONTROLS | 1 |
| | OVERVIEW OF DISPLAY INDICATORS | 2 |
| 1. | GETTING TO KNOW YOUR BALANCE | 3 |
| 1.1 | Introduction | 3 |
| 2. | INSTALLATION | 3 |
| 2.1 | Unpacking and Checking the Standard Equipment | 3 |
| 2.2 | Selecting the Location | 4 |
| 2.3 | Setting Up and Leveling the Balance | 4 |
| 2.4 | Installing Pan | 5 |
| 2.5 | Wind Shield | 5 |
| 2.6 | Connecting Power | 5 |
| 3. | OPERATING YOUR BALANCE | 6 |
| 3.1 | The Menu (Basic Settings of the Instrument) | 6 |
| 3.2 | Turning On the Balance | 7 |
| 3.3 | Calibration | 7 |
| 3.3.1 | Internal Calibration (InCAL™) | 9 |
| 3.3.2 | Calibration Message | 10 |
| 3.3.3 | Calibration Adjust | 11 |
| 3.3.4 | Span Calibration | 12 |
| 3.3.5 | User Calibration | 13 |
| 3.3.6 | Linearity Calibration | 14 |
| 3.3.7 | Calibration Test | 15 |
| 3.3.8 | Calibration GLP Printout | 16 |
| 3.4 | Weighing | 17 |
| 3.5 | Percent Weighing | 18 |
| 3.6 | Parts Counting | 19 |
| 3.7 | Animal Weighing | 20 |
| 3.8 | Weigh Below | 21 |
| 3.9 | Printing Data | 21 |
| 4. | SETTING UP YOUR BALANCE | 22 |
| 4.1 | Setting Date and Time | 22 |
| 4.2 | Readout | 23 |
| 4.3 | Good Laboratory Practices (GLP) Data | 24 |
| 4.4 | Good Laboratory Practices (GLP) Set | 24 |

TABLE OF CONTENTS (Cont.)

| | | |
|-----------|-----------------------------------|-----------|
| 4.5 | Print | 25 |
| 4.6 | RS232 | 27 |
| 4.7 | Legal for Trade (LFT) | 28 |
| 4.8 | Mode | 29 |
| 4.9 | Units | 30 |
| 4.10 | Global | 30 |
| 4.11 | Custom Unit | 32 |
| 4.12 | Menu Lock-Out Protection | 34 |
| 5. | CARE AND MAINTENANCE | 35 |
| 5.1 | Troubleshooting | 35 |
| 5.2 | RS232 Interface | 36 |
| 5.3 | Error Codes List | 39 |
| 5.4 | Information Messages | 39 |
| 5.5 | Service Information | 40 |
| 5.6 | Replacement Parts | 40 |
| 5.7 | Accessories | 40 |
| 5.8 | Specifications | 41 |

OVERVIEW OF CONTROLS

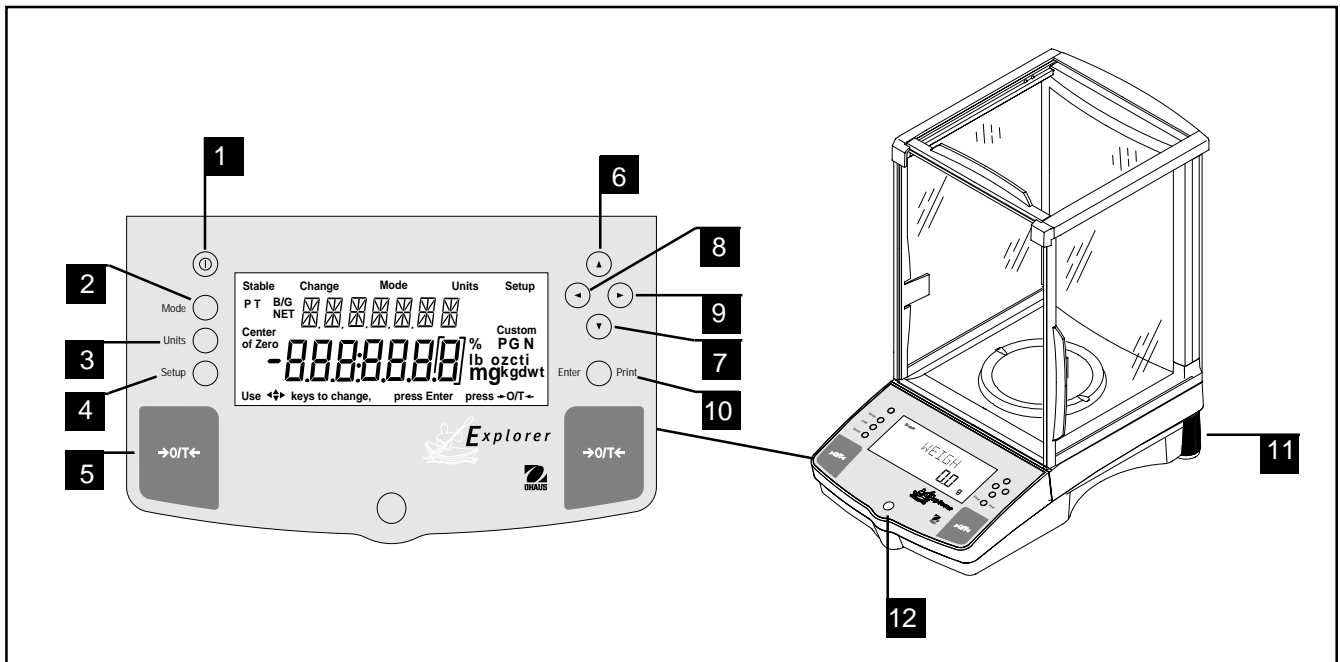

| No. | Designation | Function |
|-----|--------------------|--|
| 1 | Ⓚ | Power on off button. |
| 2 | Mode button | Selects standard weighing, percent, parts counting and animal weighing modes. |
| 3 | Units button | Selects weighing units. |
| 4 | Setup button | Selects various submenus: calibration, date, time, readout, GLP data, GLP set, print, RS232, LFT, function, units, global, custom. |
| 5 | >O/T< button | When pressed, performs tare function and a center of zero function. |
| 6 | ▲ button | When pressed, travels up through submenus. |
| 7 | ▼ button | When pressed, travels down through submenus. |
| 8 | ◀ button | When pressed, travels to the left through menus. |
| 9 | ▶ button | When pressed, travels to the right through menus. |
| 10 | Enter/Print button | When in menus, selects item on display, otherwise prints data. |
| 11 | Leveling feet | Used to level the balance. |
| 12 | Leveling indicator | Indicates leveling position of the balance. |

OVERVIEW OF DISPLAY INDICATORS

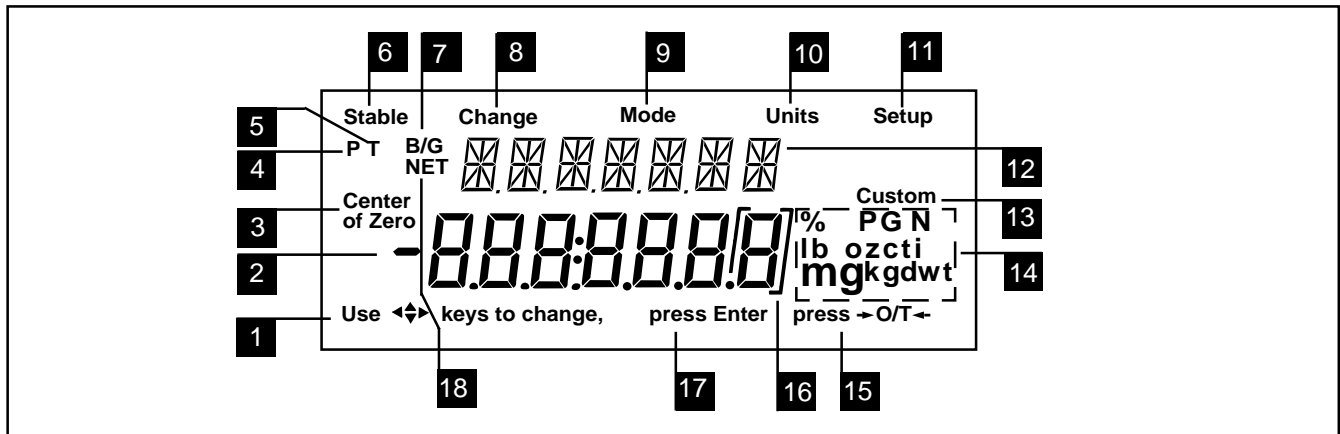

| No. | Function |
|-----|--|
| 1 | Use (Pointer Group) key to change - used to prompt the user while navigating through the menu system. |
| 2 | Standard (7) segment numeric characters. Seven characters are available and are used for displaying weight values. |
| 3 | Center of Zero - Indicates Center of Zero in Legal For Trade (LFT) has been selected in menu. |
| 4 | P - This symbol is not used. |
| 5 | T - This symbol is not used. |
| 6 | Stable - Indicates that the measured value has become stable. |
| 7 | B/G - This symbol is not used. |
| 8 | Change - Is displayed together with Mode , Units or Setup signifying that a change to balance settings is being performed. |
| 9 | Mode - Is displayed when the Mode button is pressed. Allows the user to know what area of the balance menu is being addressed. |
| 10 | Units - Is displayed when the Units button is pressed. Allows the user to know what area of the balance menu is being addressed. |
| 11 | Setup - Is displayed when the Setup button is pressed. Allows the user to know what area of the balance menu is being addressed. |

| No. | Function |
|-----|--|
| 12 | (British Flag) - Are (14) segment alpha numeric characters. Seven characters are used to present features and functions. |
| 13 | Custom - The user can input a factor to meet unique unit measure applications. |
| 14 | Symbols for weighing modes, include: % - Percent weighing. PC - Parts counting. GN - Grain. N - Newtons. m - Mommies. mg - Milligrams. g - Grams. kg - Kilograms. dwt - Pennyweight. lb - Pounds. oz - Ounces. ct - Carats. t - Taels. Taels are available in three types; Hong Kong, Singapore, and Taiwan. ti - Tical. ozt - Ounces troy. |
| 15 | press # - This symbol is not used. |
| 16 | [] - Differentiated digit for LFT. |
| 17 | press Enter - Used as a prompt to the user to press the Enter button. The menu item displayed is accepted/selected. |
| 18 | NET - Not Used NOTE: Availability of shaded weighing units subject to local regulations. |

1. GETTING TO KNOW YOUR BALANCE

Please read through this section carefully, as it contains important information for safe and economical operation of your Explorer Balance.

1.1 Introduction

Thank you for deciding to purchase an Explorer Balance from Ohaus. Thanks to a new modular design, your Explorer Balance lets you adapt the balance to your changing needs. Remote displays, upgraded displays which can be table, wall or tower mounted are available as accessories. It offers a high level of operating convenience and useful functions to make accurate measurements. A unique LCD panel has a large 7 digit, 7 segment display which indicates the weight value of an item being measured and a 7 digit British Flag display (14 segments) which spells out items selected in the submenus. In addition, the display contains English words to indicate the status of the balance. Arrow indicators in the display prompt the user as to what panel keys are to be pressed to initiate a change.

Panel controls are clearly marked as to their function with large Tare buttons on either side of the front panel. Operation and setup of the balance is straightforward and easy. The Explorer Balance is available in a variety of full scale capacities ranging from 62 grams to 8,100 grams with FineRange™ range models available. Legal for Trade versions are available.

Behind your instrument stands OHAUS, a leading manufacturer of precision scales and balances. An Aftermarket Department with trained instrument technicians is dedicated to provide you with the fastest service possible in the event your instrument requires servicing. OHAUS also has a Customer Service Department to answer any inquiries regarding applications and accessories.

To ensure you make full use of the possibilities offered by your Explorer balance, we advise you to read through these operating instructions very carefully.

2. INSTALLATION

2.1 Unpacking and Checking the Standard Equipment

Open the package and remove the instrument and the accessories. Check the completeness of the delivery. The following accessories are part of the standard equipment of your new Explorer balance.

| Equipment | Analytical | Top Loader | | |
|-------------------------------------|--|----------------------------|---|---------------------------|
| | 62 g, 110 g, 162 g 210 g, 210/100 g | 210, 410, 610 410/100 g | 610 g, 1550 g, 2100 g, 4100 g, 6100, 4100/1000 g | 6100 g, 4100 g, 8100 g |
| • Pan 3.5 | ✓ | | | |
| • Pan 4.75" | | ✓ | | |
| • Pan 6" (0.01 g units) | | | ✓ | ✓ * |
| • Pan 8" (0.1 g units) | | | | ✓ |
| • Draft Shield | ✓ | ✓ | | |
| • Wind Shield (6" Pan Units, 0.01g) | | | ✓ | ✓ * |
| • AC Power Adapter | ✓ | ✓ | ✓ | ✓ |
| • Instruction Manual | ✓ | ✓ | ✓ | ✓ |
| • Warranty Card | ✓ | ✓ | ✓ | ✓ |

- * 4100 g, 6100 g and 8100 g balances with internal calibration are equipped with a 6" Pan and Windshield.
- Remove packing material from the instrument.
- Check the instrument for transport damage. Immediately inform your Ohaus dealer if you have complaints or parts are missing.
- Store all parts of the packaging. This packaging guarantees the best possible protection for the transport of your instrument.

2.2 Selecting the Location

The balance should always be used in an environment which is free from excessive air currents, corrosives, vibration, and temperature or humidity extremes. These factors will affect displayed weight readings.

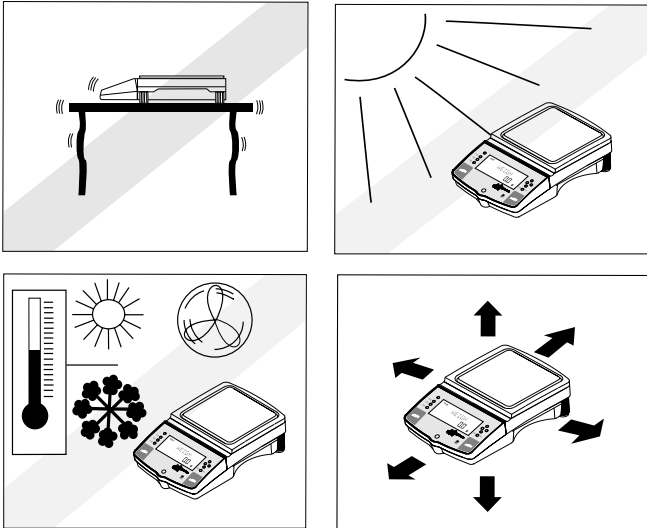

DO NOT install the balance:

- Next to open windows or doors causing drafts or rapid temperature changes.
- Near air conditioning or heat vents.
- Near vibrating, rotating or reciprocating equipment.
- Near magnetic fields or equipment that generates magnetic fields.
- On an unlevel work surface.
- Allow sufficient space around the instrument for ease of operation and keep away from radiating heat sources.

2.3 Setting Up and Leveling the Balance

Exact horizontal positioning and stable installation are prerequisites for repeatable results. To compensate small irregularities or inclinations at the location, the instrument can be leveled.

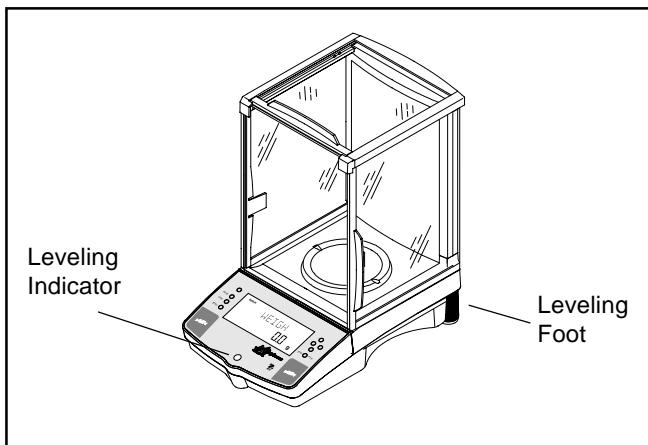

For exact horizontal positioning, the balance is equipped with a level indicator located at the front on the control panel and two leveling feet located at the rear of the balance.

Position the balance in the intended operating location. Adjust the leveling feet at the rear of the balance until the air bubble in the indicator is centered.

NOTE: The instrument should be leveled each time its location is changed.

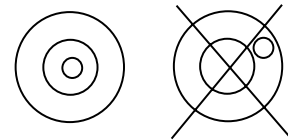

2.4 Installing Pan

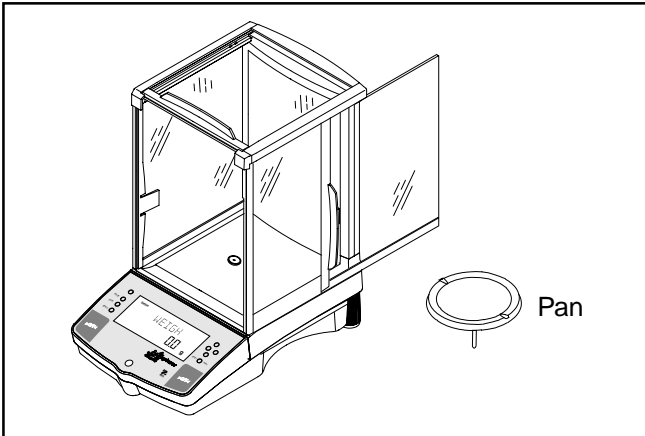

Balances are shipped with the pan not installed. On balances equipped with a draft shield, slide open the side door and insert the pan into the center hole which is the measuring transducer.

2.5 Wind Shield

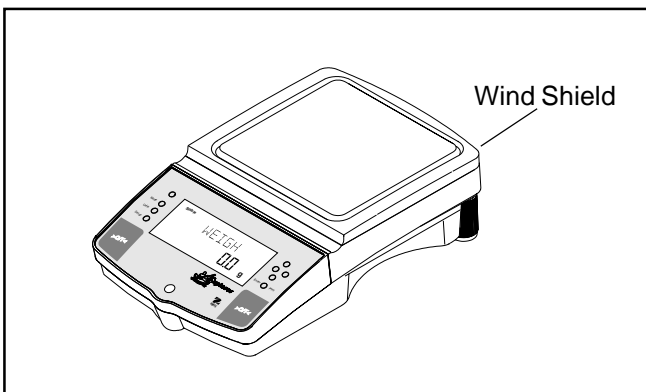

On 610 g to 4100 g balances with 0.01 g resolution, a wind shield is required to reduce the possibility of air currents from disturbing the pan. When the wind shield is in place, air currents are deflected up over the pan. Make sure the wind shield is firmly snapped into place.

NOTE: 4100 g, 6100 g and 8100 g balances with internal calibration are equipped with a 6" Pan and Windshield.

2.6 Connecting Power

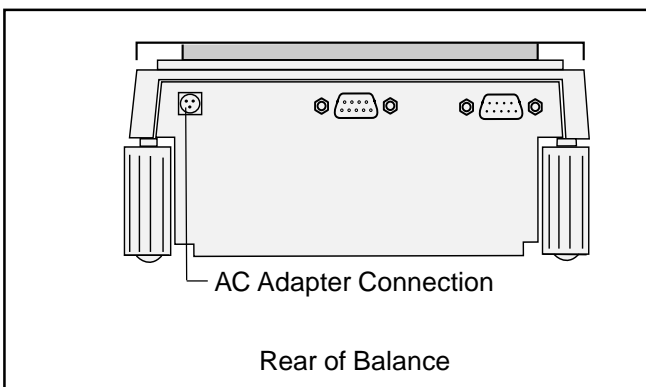

Connect the AC Adapter supplied to the three pin connector located at the rear of the balance.

The balance is now ready for operation.

3 OPERATING YOUR BALANCE

3.1 The Menu (Basic Settings of the Instrument)

The Explorer balance has three basic menus; each is selected by front panel buttons marked **Mode**, **Units** and **Setup**.

Mode Button

The Mode button, when pressed, permits the selection of four weighing modes which are: weigh, percent, count and animal weighing. These modes are controlled by an on or off selection made in the Setup menu under the submenu **Mode** as displayed.

Units Button

The Units button, when pressed, allows the balance to display values in selected measuring unit.

Setup Button

The Setup button, when pressed, allows entry into thirteen submenus which allows you to set the balance for specific operating parameters. Each of the thirteen submenus contain settings which are user selectable. The table below illustrates the various submenus and the functions which are selectable. The items shown on the menu, which are bolded, are the factory default settings. In other words, if you did not enter the Setup menu, the balance would function in the basic manner shown by the various settings which are bolded. The setup submenus shown below are arranged in the order as displayed in the balance.

START

SETUP SUBMENUS

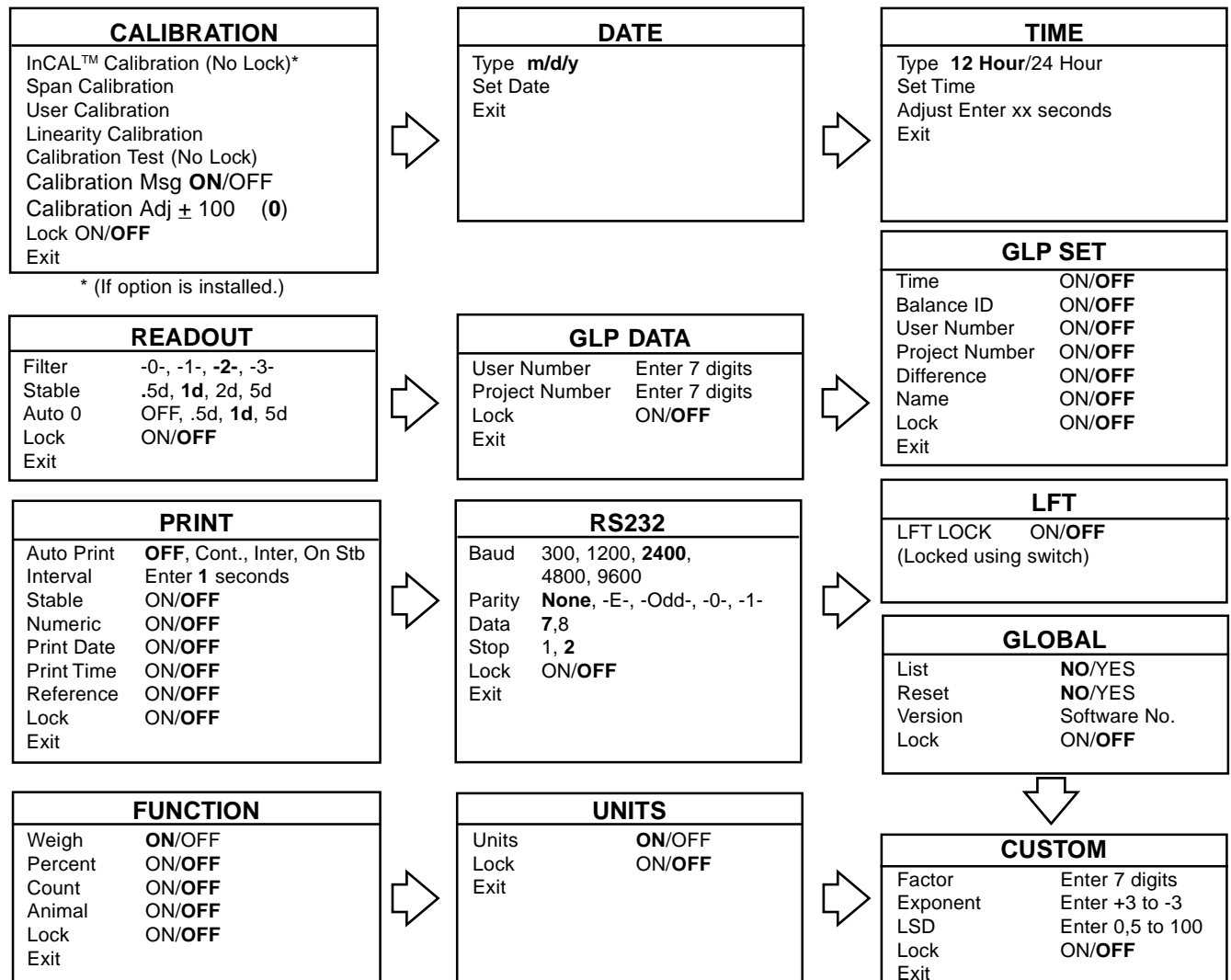

3.2 Turning On the Balance

The Explorer balance is ready to operate after the installation procedures are performed. When the balance is first turned on and it completes its checks, it can be used to weigh or tare materials without setting the menus.

It is recommended that you read this manual carefully and set the balance to operate for your specific applications using the procedures in Chapter 4 Setting up Your Balance and calibrate the balance before using.

The balance is a high precision instrument and will give you years of service if kept clean and handled carefully. If you have any problems operating the instrument or require additional information, please feel free to contact Ohaus Corporation.

In this section, you will enter the menu for the first time. Do not worry if you are unfamiliar with the function of the buttons on the panel, the display provides the necessary coaching as you go along.

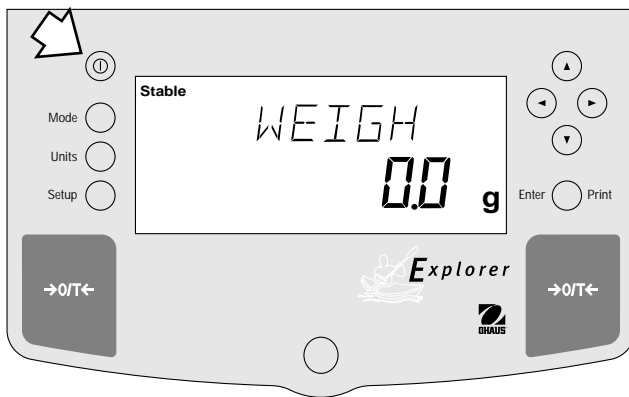

Power On/Off

To turn the balance ON, press the ON/OFF button (circled button with an I inside) located at the upper left-hand corner of the panel once. To turn OFF, press button again.

Stabilization

Before initially using the balance, allow time for it to adjust to its new environment. The balance only requires to be plugged in to warm up. Recommended warm up period is twenty (20) minutes. Analytical Class I balances require at least 2 hours. The internal circuits of the balance are powered whenever it is plugged into a power source.

Calibration

Refer to paragraph 3.3 and calibrate the balance before proceeding.

3.3 Calibration

Explorer balances offer a choice of five calibration methods: Internal Calibration (InCAL™), Span Calibration, User Calibration, Linearity Calibration, and CalTest™.

- **InCal™** - Internal calibration (InCAL™) of the balance is accomplished by an internal mass (If option is installed). When CAL MSG is selected and set ON, CAL NOW is displayed when the balance requires calibration. When CAL MSG is set OFF, the message CAL NOW is not displayed.
- **Span** - Span calibration ensures that the balance reads correctly within specifications using two weight values: zero and a weight value at incremental values of full capacity and or 100 % of the balance's full capacity.
- **User** - User calibration is a method where the balance can be calibrated using a mass of known value and by entering that numeric value into the balance.
- **Linearity** - Linearity calibration minimizes deviation between actual and displayed weights within the balance's weighing range. Three weight values are used: zero, a weight value at midpoint of the balance's weighing range, and a weight value at or near the balance's specified capacity.
- **Cal Test** - Calibration test allows the stored calibration data to be tested against the current mass being used for the test.
- **Lock** - Can be set on or off. When set on, Span, User and Linearity are locked out and cannot be used.

3.3 Calibration (Cont.)

Calibration Menu Protection

NOTES:

- Calibration may be locked out to prevent unauthorized personnel from changing calibration. If calibration has been locked out, you can only access Cal Test and when installed, Internal Calibration (InCAL™) .
- To lock out calibration menu, after calibration, refer to the section titled Menu Lock-Out Protection.

Calibration Masses

Before beginning calibration, make sure masses are available. If you begin calibration and realize calibration masses are not available, exit the menu. The balance will retain previously stored calibration data. Calibration should be performed as necessary to ensure accurate weighing. Masses required to perform the procedures are listed in the adjacent table.

NOTE:

Any of the calibration modes can be terminated *at any time* by pressing either the **Mode**, **Units** or **Setup** buttons.

CALIBRATION MASSES

| CAPACITY | LINEARITY MASSES | SPAN ONLY MASSES |
|-----------------|-------------------------|-------------------------|
| 62 g | 20g/50 g | 50 g |
| 162 g | 50g/150 g | 150 g |
| 110 g | 50g/100 g | 100 g |
| 210 g | 100g/200 g | 200 g |
| 410 g | 200g/400 g | 400 g |
| 610 g | 200g/500 g | 500 g |
| 1550 g | 500g/1500 g | 1500 g |
| 2100 g | 1000g/2000 g | 2000 g |
| 4100 g | 2000g/4000 g | 4000 g |
| 6100 g | 2000g/5000 g | 5000 g |
| 8100 g | 4000g/8000 g | 8000 g |

It is recommended that masses must meet or exceed ASTM Class 1 Tolerance. Calibration masses are available as accessories.

3.3.1 Internal Calibration (InCAL™)

On Explorer balances equipped with the InCal™ feature, calibration can be accomplished using the internal calibration mass. When the balance requires calibration, a screen prompt of CAL NOW appears. This display can be turned off as described in paragraph 3.3.2. Also, a software adjust feature is incorporated which permits the internal calibration mass to be adjusted to ± 100 counts. The adjust feature is described in paragraph 3.3.3. Internal calibration can be performed at any time providing the balance has warmed up to operating temperature.

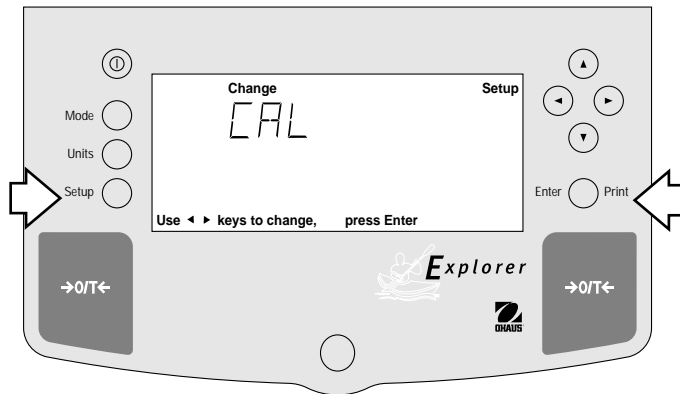

Procedure

- Press the **Setup** button, CAL is displayed.
- Press **Enter** button, CAL TYPE is displayed.
- Press **Enter** button, CAL TYPE InCAL is displayed.
- Press **Enter** button, INCAL is displayed.

IMPORTANT !

DO NOT DISTURB THE BALANCE DURING CALIBRATION. IF THE MESSAGE UNSTBLE IS DISPLAYED, THE BALANCE WAS UNABLE TO ACQUIRE STABLE DATA DURING INTERNAL CALIBRATION. THE BALANCE WILL CONTINUE TO PERFORM INTERNAL CALIBRATION UNTIL READINGS STABILIZE. THE BALANCE WILL THEN COMPLETE THE INTERNAL CALIBRATION FUNCTION.

TO EXIT INTERNAL CALIBRATION MODE BEFORE COMPLETION, PRESS ENTER OR SETUP BUTTONS.

STABILITY CAN BE AFFECTED BY TEMPERATURE, AIR CURRENTS, VIBRATION, ETC...

NOTE: If a weight is left on the pan, the balance will display CLR PAN (remove the weight from the pan). The balance automatically resumes calibration.

The internal mass is positioned several times during calibration and then removed, then after a few seconds, CAL SET is displayed indicating a successful calibration. The display then returns to WEIGH mode.

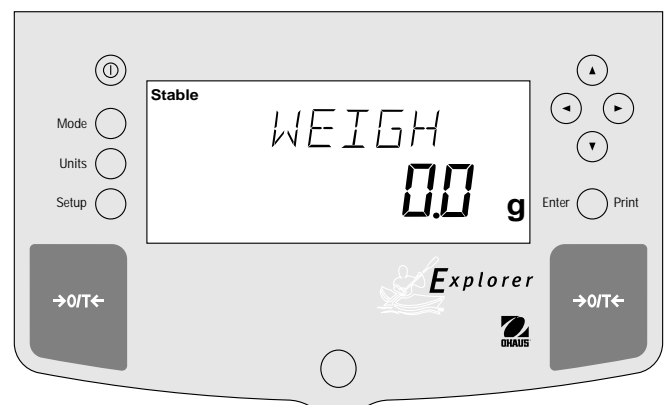
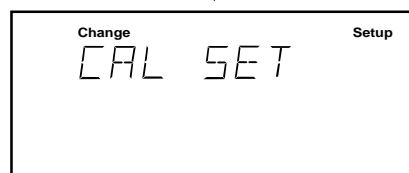
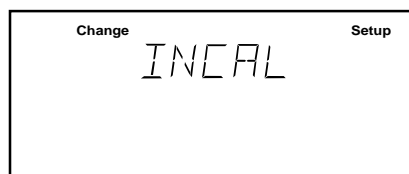
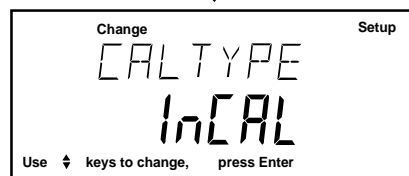
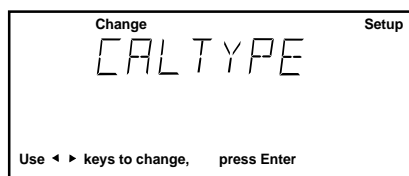

3.3.2 Calibration Message

On Explorer balances equipped with the InCal™ feature, a screen prompt of CAL NOW appears when the balance requires calibration. This display can be turned off if it is desired not to have the balance indicate that calibration is required. Turning the display off has no effect on the basic balance operation.

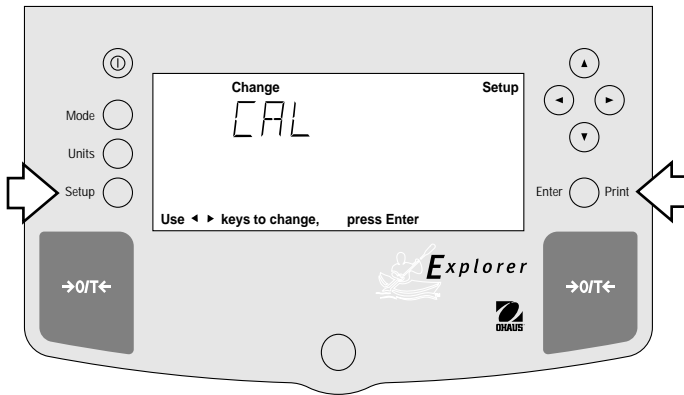

Procedure

- Press the **Setup** button, CAL is displayed.
- Press **Enter** button, CAL TYPE is displayed.
- Press **▶** button, CAL MSG is displayed.
- Press **Enter** button, CAL MSG ON is displayed.
- Press **▲** or **▼** button and select either ON or OFF. When OFF is selected, the CAL NOW message will not appear in the display.

NOTE: When the balance is in a legal for trade mode, this option is locked ON. In this condition, the balance will display the CAL NOW message when recalibration is required.

- Press **Enter** button, SAVED is momentarily displayed, then the display indicates CAL ADJ.

NOTE: At this point you may continue with the calibration adjust procedure on the next page or exit.

The calibration adjust procedure is only used when it is desired to calibrate the internal calibration mass to a known external Class I mass if a difference exists.

- Press **▶** button until EXIT is displayed.
- Press **Enter** button, display returns to WEIGH mode.

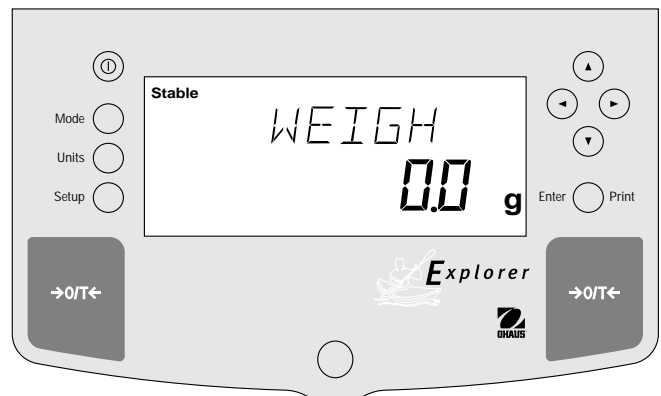
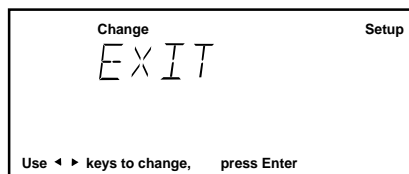
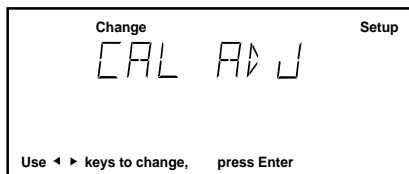
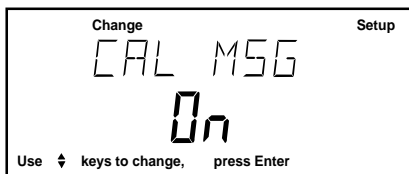
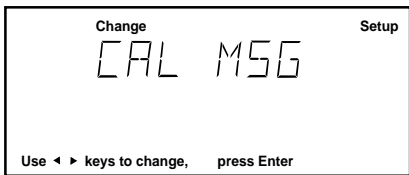
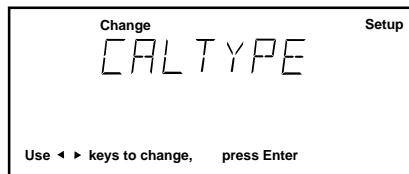

3.3.3 Calibration Adjust

Balances with InCal™ contain software which allows the internal calibration mass to be adjusted ± 100 divisions at full scale capacity. This permits calibrating the balance using an external Class I mass which is traceable to a certified standard.

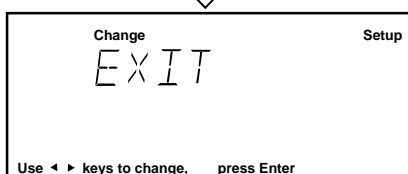
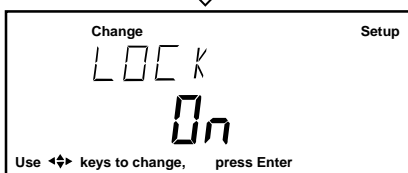
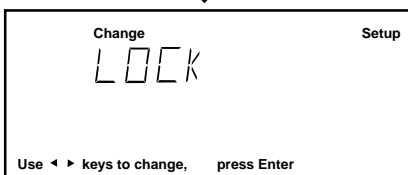
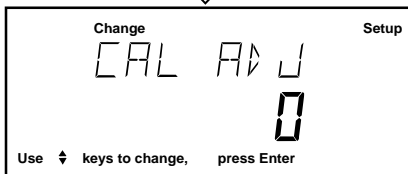
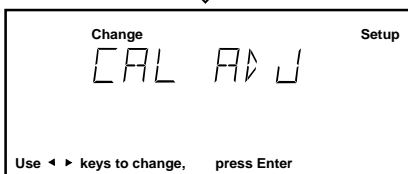
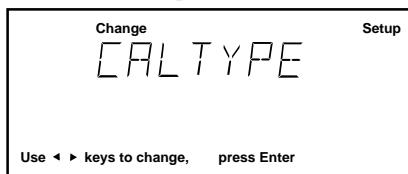
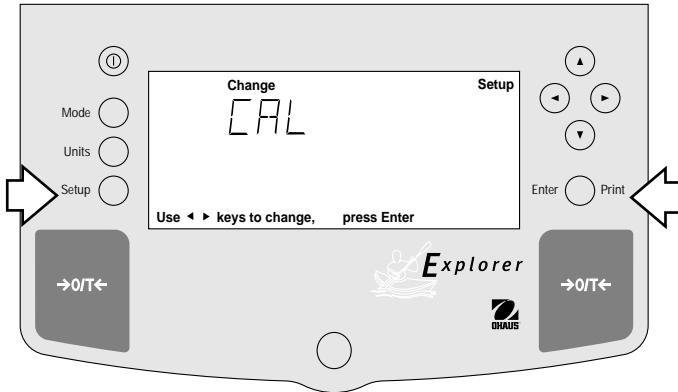

Procedure

- Perform the internal calibration procedure of paragraph 3.3.1.
- Press **#** button to zero the balance.
- Place a Class I mass equal to the **span calibration value** of the balance. Note the reading on the balance and see if the balance indicates the exact weight or indicates a higher or lower reading. If the reading is higher or lower, proceed.
- Press the **Setup** button, CAL is displayed.
- Press **Enter** button, CAL TYPE is displayed.
- Press **▶** button until, CAL ADJ is displayed.
- Press **Enter** button, CAL ADJ 0 should be displayed (0 is factory setting).
NOTE: Balance will retain last CAL ADJ setting.
- Press **▲** or **▼** button until desired number is displayed.
- Press **Enter** button, SAVED is momentarily displayed, then display indicates LOCK.
- Press **Enter** button, LOCK ON or LOCK OFF is displayed.
- Press **▲** or **▼** button and select either LOCK ON or LOCK OFF. LOCK ON is normally used in legal for trade applications. When set ON, and legal for trade is enabled in the balance, the calibration adjust is disabled and whatever setting was entered will remain in the balance.
- Press **Enter** button, SAVED is momentarily displayed, then EXIT is displayed.
- Press **Enter** button, display returns to WEIGH mode.
- Perform the internal calibration procedure of paragraph 3.3.1. The value entered as an adjustment is now stored. Place the calibration mass on the pan and check. Repeat procedure if further correction is required. The display must agree with the mass used for calibration.
- To return to factory setting, follow procedure above and set CAL ADJ to 0.

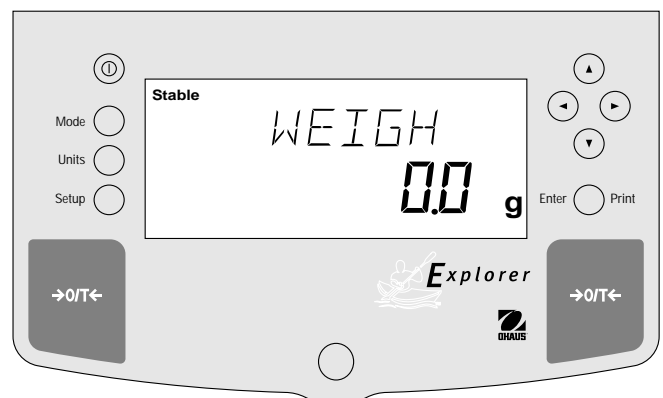

3.3.4 Span Calibration

Span calibration utilizes two calibration points, one at zero and the other at full span or incremental values starting at 25 % of full capacity. As an example, an 8.1 kg balance will accept either 2 kg, 4 kg, 6 kg or 8 kg for span calibration. Values which are below or in between will not be accepted and the balance will display its maximum capacity. When LFT is set on, only full span calibration value can be used. Sample display illustrates an 8.1 kg balance

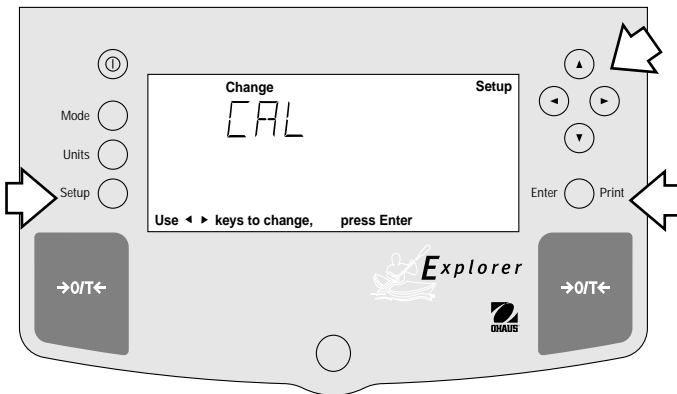

Procedure

- Press the **Setup** button, CAL is displayed.
- Press **Enter** button, CAL TYPE is displayed.
- Press **Enter** button, CAL TYPE InCAL is displayed.
- Press **▲** button to select SPAN calibration, CAL TYPE SPAN is displayed.
- Press **Enter** button, WORKING is displayed.

NOTE: If a weight is left on the pan, the balance will display CLR PAN (remove the weight from the pan). The balance automatically resumes calibration.

- Display changes to PUT WT 8000 g. The displayed weight is the full capacity of the balance.
- Place specified calibration mass on pan.

NOTE: For an 8.1 kg balance, either 2 kg, 4 kg, 6 kg or 8 kg can be used for span calibration. The PUT WEIGHT message indicates the calibration mass that is on the pan.

- Press **Enter** button, WORKING is displayed. After a few seconds CAL SET is displayed, the display then returns to WEIGH mode.
- Span calibration is completed.
- Remove calibration mass from the pan.

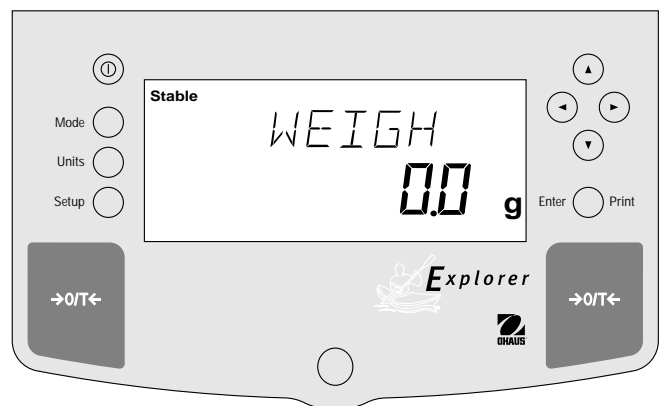
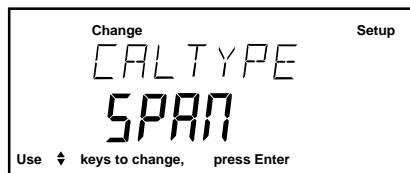
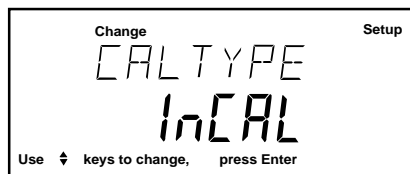
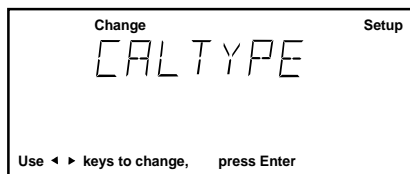



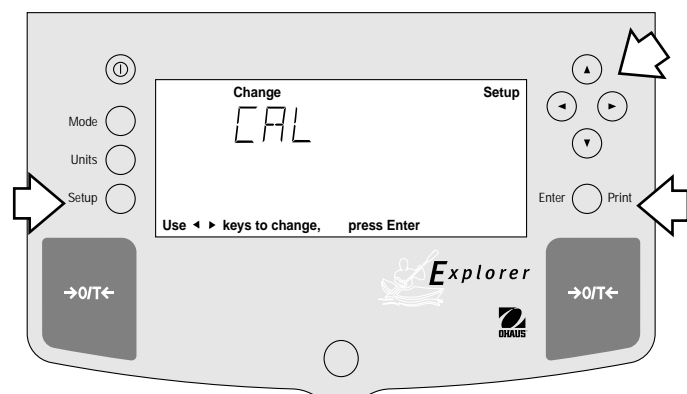

3.3.5 User Calibration

User calibration is used when it is desired to calibrate the balance using a mass of known value. When LFT is set on, the balance will only accept full span calibration, 25 %, 50 % and 75 % values are disabled. To use this calibration feature, proceed as follows:



Procedure

- Press the **Setup** button, CAL is displayed.
- Press **Enter** button, CAL TYPE is displayed.
- Press **Enter** button, CAL TYPE InCAL is displayed.
- Press  button twice to select USER calibration, CAL TYPE USER is displayed.
- Press **Enter** button, the display indicates the last calibration mass value which was entered with the first digit flashing. (Sample illustrates 2000 g).
- Press   and or   and enter the desired mass value. This number must be at least 25 % of the full span value.
- Press **Enter** button, WORKING is displayed.

NOTE: If a weight is left on the pan, the balance will display CLR PAN (remove the weight from the pan). The balance automatically resumes calibration.

- Display changes to PUT WT 2000 g.
- Place specified calibration mass on pan.
- Press **Enter** button, WORKING is displayed. After a few seconds CAL SET is displayed, the display then returns to WEIGH mode.
- User calibration is completed.
- Remove calibration mass from the pan.

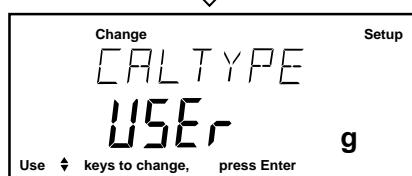
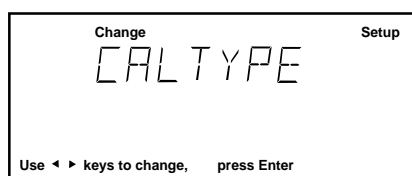

(FLASHING)

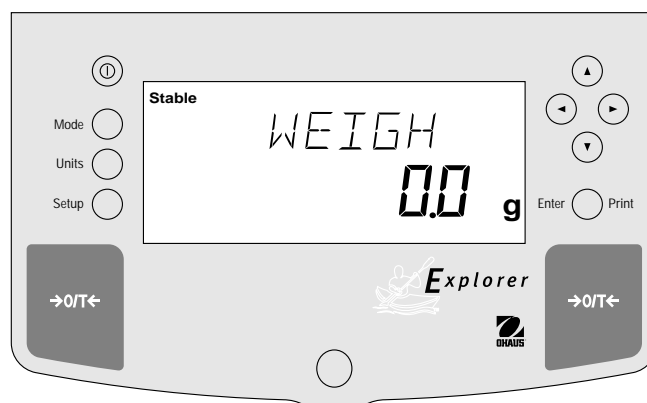

3.3.6 Linearity Calibration

Linearity calibration utilizes three calibration points, one at zero, center span and full span. This method minimizes deviation between actual and displayed weights within the balance's weighing range. Three weight values are used; zero, a weight value at midpoint of the balance's weighing range and a weight value at or near the specified capacity. Sample display illustrates an 8.1 kg balance.

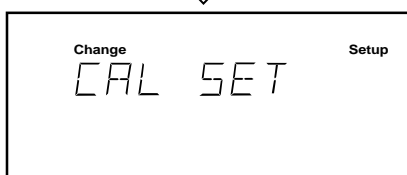
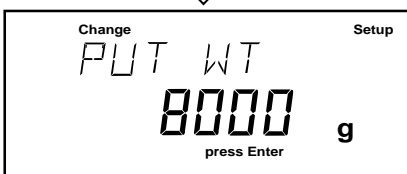
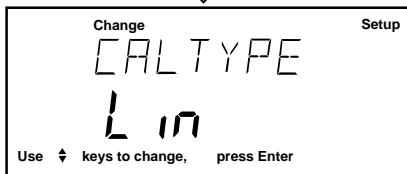
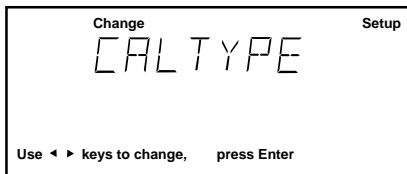
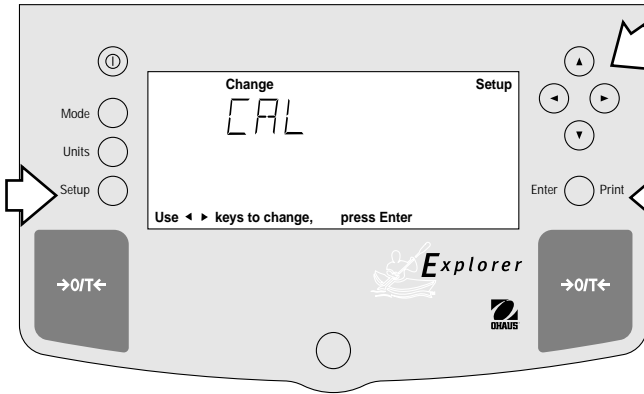

Procedure

- Press the **Setup** button, CAL is displayed.
- Press **Enter** button, CAL TYPE is displayed.
- Press **Enter** button, CAL TYPE InCAL is displayed.
- Press **▲** button three times to select LIN calibration, CAL TYPE Lin is displayed.
- Press **Enter** button, WORKING is displayed.

NOTE: If a weight is left on the pan, the balance will display CLR PAN (remove the weight from the pan). The balance automatically resumes calibration.

- Display changes to PUT WT 4000 g. The displayed weight is half the capacity of the balance.
- Place specified calibration mass on pan.
- Press **Enter** button, WORKING is displayed. After a few seconds display changes to PUT WT 8000 g. The displayed weight is the full capacity of the balance.
- Place specified calibration mass on pan.
- Press **Enter** button, WORKING is displayed. After a few seconds CAL SET is displayed, the display then returns to WEIGH mode.
- Linearity calibration is completed.
- Remove calibration mass from the pan.

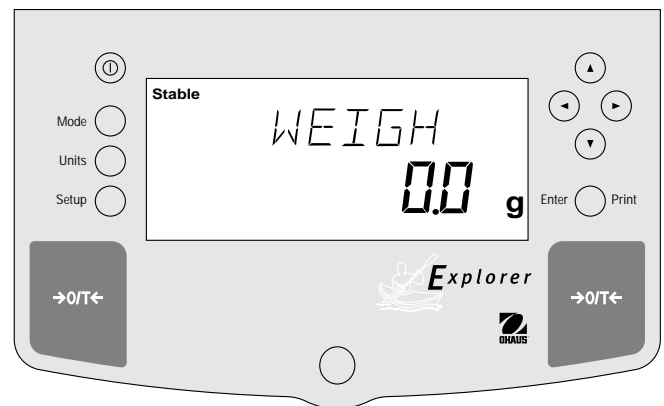

3.3.7 Calibration Test

Calibration test feature allows a check of a known calibration mass against the last stored calibration information in the balance. Sample display illustrates an 8.1 kg balance.

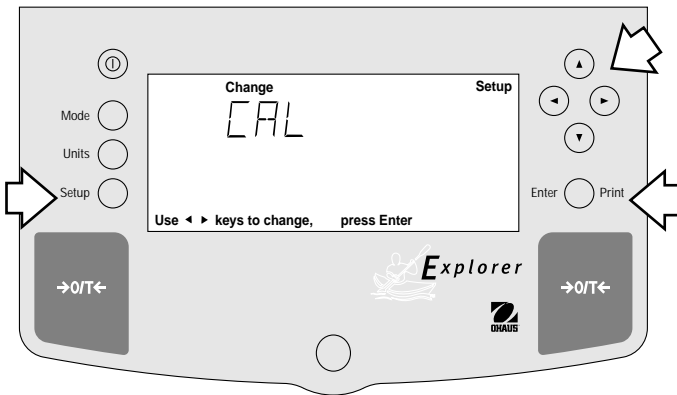

Procedure

- Press the **Setup** button, CAL is displayed.
- Press **Enter** button, CAL TYPE is displayed.
- Press **Enter** button, CAL TYPE InCAL is displayed.
- Press **▲** button to select CALTEST calibration, CALtEST is displayed.
- Press **Enter** button, WORKING is displayed.

NOTE: If a weight is left on the pan, the balance will display CLR PAN (remove the weight from the pan). The balance automatically resumes calibration.

- Display changes to PUT WT 8000 g. The displayed weight is the full capacity of the balance.
- Place specified calibration mass on pan.
- Press **Enter** button, WORKING is displayed. After a few seconds, DIFF is displayed. The display now indicates the actual difference in weight between what value was just placed on the pan and the previous weight value which was stored in the balance. After approximately 8 seconds, the display returns to the WEIGH mode.
- Remove calibration test mass from the pan.

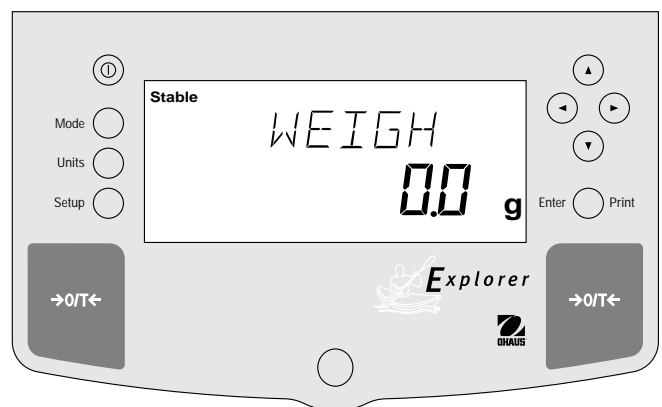
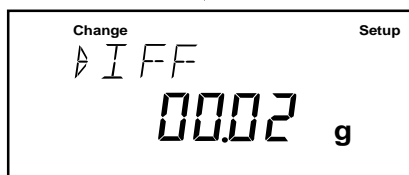
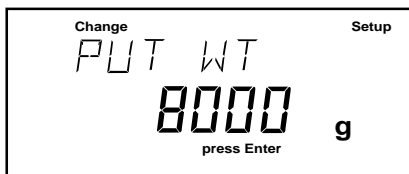
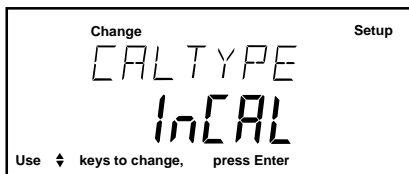

3.3.8 Calibration GLP Printout

If any option in the GLP Set Menu is turned On, GLP automatically prints data after calibration is completed.

Span Calibration Printout

When performing Span calibration with all GLP options turned on, a printout is automatically made after the calibration is completed.

```

----- SPAN CAL -----
12/01/97  1:00:00 PM
Bal Id 1234
Cal:      8000.00 g
Old:      8000.00 g
Dif:      0.00 g
Wt. Ref.....
USER NO 2056853
PROJ NO 100012
Name.....

----- END -----

```

InCAL™ Calibration Printout

When performing InCAL™ calibration with all GLP options turned on, a printout is automatically made after the calibration is completed.

```

----- INCAL -----
12/01/97  1:00:00 PM
Bal Id 1234
Cal:      8000.00 g
Old:      8000.00 g
Dif:      0.00 g
Wt. Ref.....
USER NO 2056853
PROJ NO 100012
Name.....

----- END -----

```

Linearity Calibration Printout

When performing a Linearity calibration with all GLP options turned on, a printout is automatically made after the calibration is completed.

```

----- LIN CAL -----
12/01/97  1:00:00 PM
Bal Id 1234
Cal:      8000.00 g
Old:      7999.08 g
Dif:      0.02 g
Wt. Ref.....
USER NO 2056853
PROJ NO 100012
Name.....

----- END -----

```

Calibration Test Printout

When performing a Calibration Test with all GLP options turned on, a printout is automatically made after the calibration is completed.

```

----- CAL TEST -----
12/01/97  1:00:00 PM
Bal Id 1234
Cal:      8000.00 g
Act:      8000.02 g
Dif:      0.02 g
Wt. Ref.....
USER NO 2056853
PROJ NO 100012
Name.....

----- END -----

```

3.4 Weighing

NOTE: The Explorer balances are shipped with grams only enabled. When the balance is to be used with other Type Approved/Legal for Trade units of measure, the desired unit must be enabled. Refer to paragraph 4.9 to enable other measuring units.

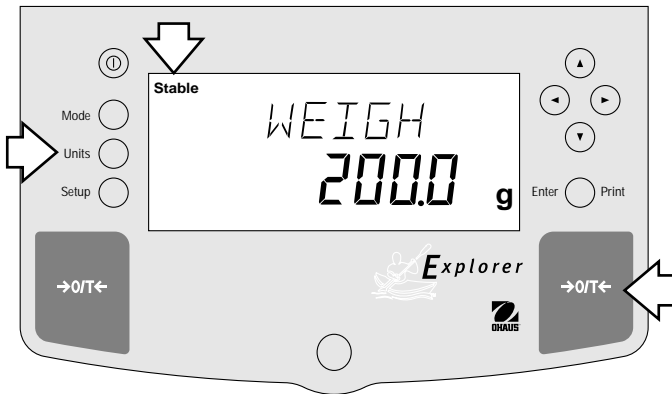

Procedure

- Press # to rezero the display.
- Press **Units** button to select measuring unit.
- Press ◀ or ▶ button for desired measuring unit.
- Press **Enter** button, balance is now ready for weighing.
- Place the object(s) or material to be weighed on the pan. Example illustrates a 200 gram weight.
- Wait for the stability indicator to appear before reading the weight.

Zero/Tare

When weighing material or objects that must be held in a container, taring stores the container weight in the balance's memory, separate from the weight of the material in the container.

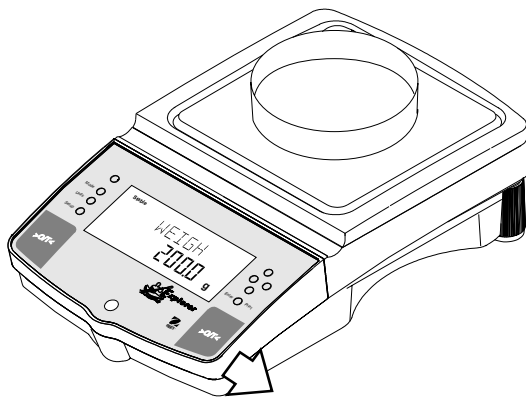

(Example Container 200 g)

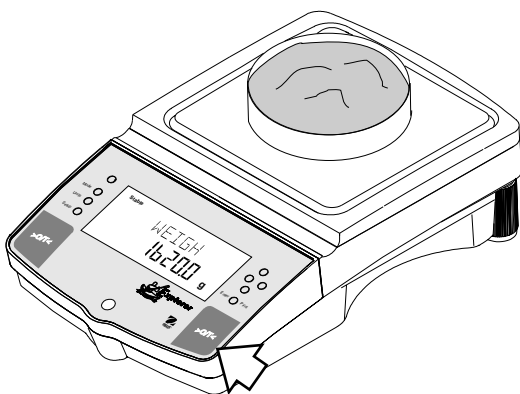

(Example Material 1620 g)

Procedure

- Press # with no load on the pan to set the balance to zero.
- Place an empty container on the pan. Its weight is displayed.
- Press # the display blanks until stable weight readings are received, then indicates zero. The container's weight is stored in memory.
- Add material to the container. As material is added, its net weight is displayed.
- Removing the container and material from the platform will cause the balance to display the container's weight as a negative number. The tared weight will remain in memory until # is pressed again or the balance is turned off.
- Pressing # resets the balance to zero.

NOTE: When Legal for Trade software option LFT NET and LFT LOCK are both set ON, the balance indicates NET WEIGH.

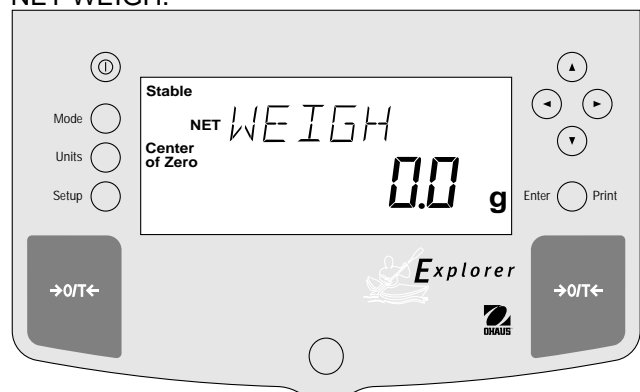

3.5 Percent Weighing

Percent Weighing is **enabled only** when Percent is turned ON in the Mode submenu under Setup. Percent weighing permits you to place a reference load on the balance, then view other loads as a percentage of the reference. The load you place on the pan as a reference may be displayed as any percentage you select from 5 % to 100 % (in 1 % increments). One hundred percent does not necessarily have to represent the reference load. Subsequent loads, displayed as a percentage of the reference are limited only by the capacity of the balance. The default setting is Reference 100 %. Refer to paragraph 4.8 to enable percent weighing.

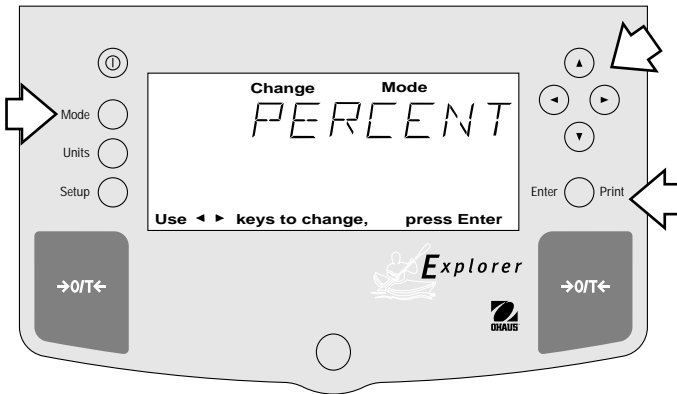

Procedure

- Press the **Mode** button.
- Press ◀ or ▶ button until PERCENT is displayed.
- Press **Enter** button, PUT>PAN 100 % is displayed. If a container is used, the balance can be tared at this point. The % display momentarily blanks while the balance is taring out.
- Put the reference load on the pan.
- Press ▲ or ▼ button and select reference weight percentage (Percent Range 5 to 100). Hold button down for fast change.
- Press **Enter** button to save setting, WORKING is displayed ... calculating reference weight.

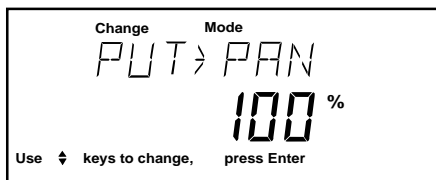

Balance displays reference weight for five seconds in selected measuring unit, then displays the percentage.

- Remove the reference weight from the pan and replace it with another load. The second load is displayed as a percentage of the reference.

NOTE: The PERCENT display (number of digits) is a function of the accuracy of the balance and the size of the reference weight. The display examples were with a 300 g mass used with an 8.1 kilogram balance.

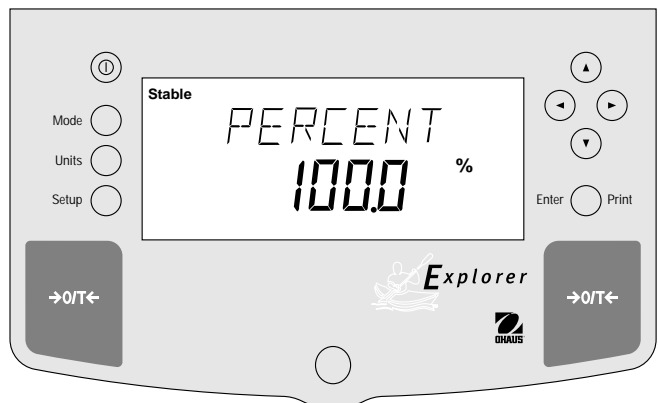

3.6 Parts Counting

Parts Counting is **enabled only** when Count is turned ON in the Mode submenu under Setup and selected with the **Mode** button. In the parts counting mode, the balance displays the quantity of parts you place on the pan. Since the balance determines the quantity based on the average weight of a single part, all parts must be reasonably uniform in weight.

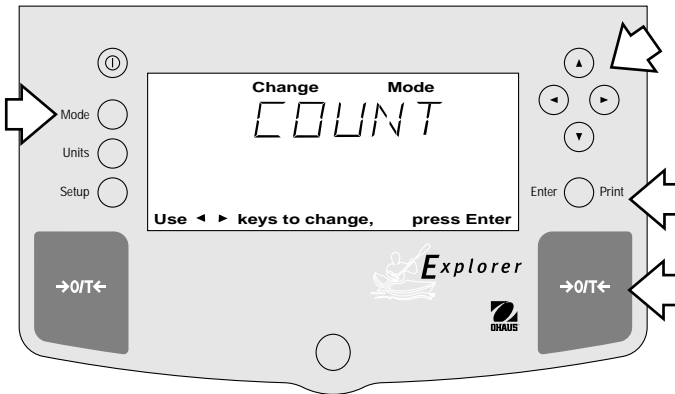

Procedure

- Press the **Mode** button.
- Press ◀ or ▶ button until COUNT is displayed.
- Press **Enter** button to save setting, PUT>PAN 10 PC is displayed (default setting), balance will retain last sample size saved.
- Press # if taring is required.
- Press ▲ or ▼ button and select sample size. Sample size is 5 to 1000 pieces.
- Place sample size on the pan.
- Press **Enter** button to continue, display indicates WORKING.

Balance displays the reference weight of an individual piece part for five seconds and then displays the total number pieces on the pan.

- Remove the sample and place parts to be counted on the pan. Balance displays number of pieces.

Update

Update is a function which permits placing additional samples which are greater than the value of the original sample but less than three times the value. This action increases the accuracy of the measurement.

- Place sample on the pan which is at least one but not more than three times the original sample size.
- Press **Mode** button, COUNT is displayed.
- Press **Enter** button, UPDATE is displayed.
- Press **Enter** button, WORKING is displayed then the reference weight followed by the new sample size.

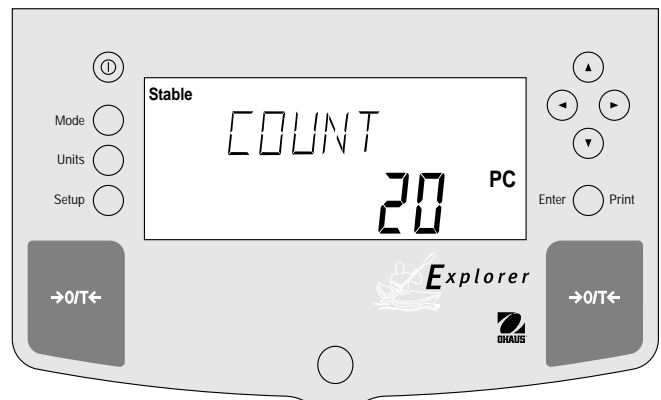
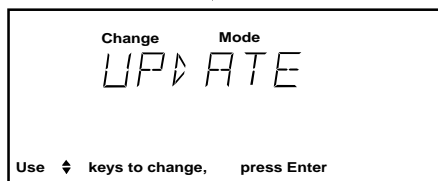
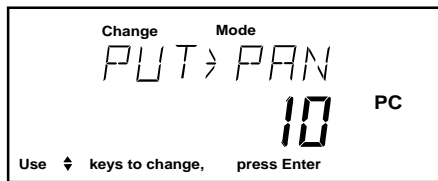

3.7 Animal Weighing

Animal Weighing is **enabled only** when Animal is turned ON in the Mode submenu under Setup.

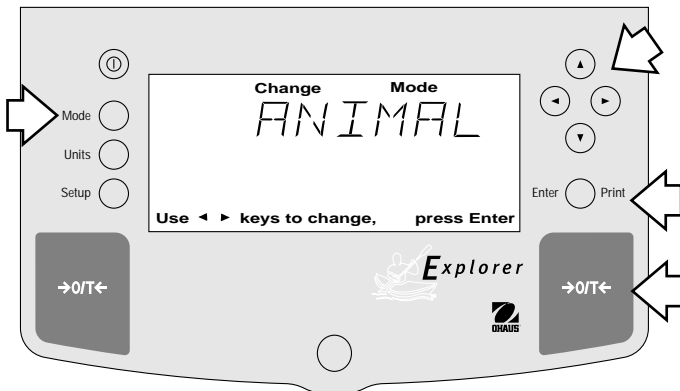

Procedure

- Press the **Mode** button.
- Press ◀ or ▶ button until ANIMAL is displayed.
- Press **Enter** button to continue, LEVEL is displayed.
- Press ▲ or ▼ button to change animal weighing level, 0, 1, 2 or 3. 0 level represents an inactive subject, 3 is used for a very active subject.
- Press **Enter** button to continue, AUTO is displayed.
- Press ▲ or ▼ button to select AUTO ON or OFF.
- Press **Enter** button to continue.

When the AUTO function is set ON, different subjects can be weighed one after another without pressing any buttons. When the balance displays READY, simply place subject on pan.

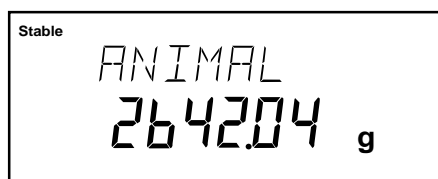
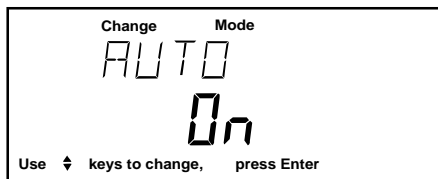
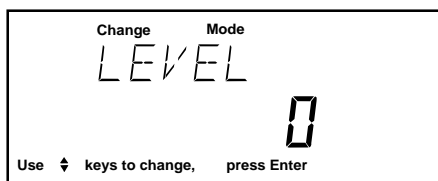

Starting Animal Cycle

- Place animal container if used on pan.
- Press # to tare the container.
- Place subject on pan.
- The animal cycle will automatically start if AUTO was set to ON.
- Press **Enter** button to start animal cycle if AUTO was set to OFF.

During Animal Cycle

- Display shows countdown to AW0.

Completed Animal Cycle

- Balance displays weight until subject is removed from the pan.

3.8 Weigh Below

The Explorer balance is equipped with a weigh below hook at the bottom of the balance. To use this feature, remove power from the balance and remove the protective cover underneath the balance. See illustration for location. The balance can be supported using lab jacks or any other convenient method. Make sure the balance is level and secure. Apply power and operate the balance. Attach items to be weighed to the hook underneath the balance.

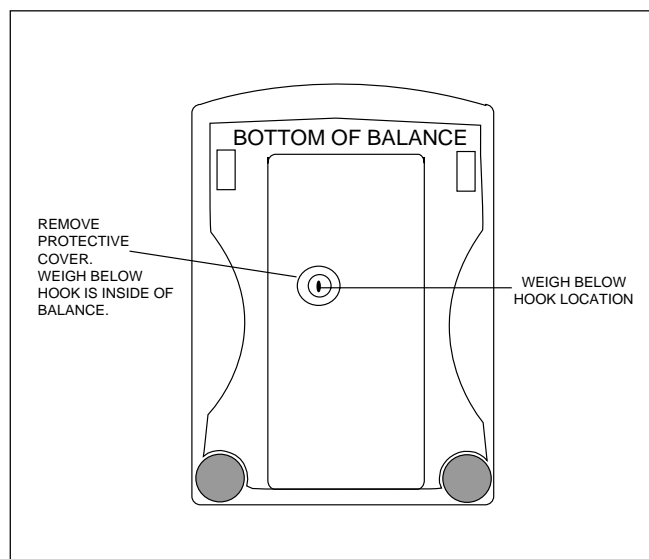

3.9 Printing Data

Printing data to an external computer or printer requires that the communications parameters in the Setup menu, Print options and communication parameters be set first. Refer to page 25 Print menu settings and page 27 for RS232 communication settings.

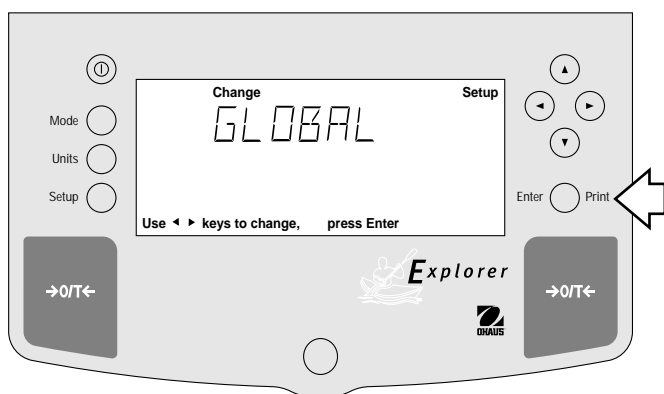

Procedure

- Press the **Print** button. Printing to an external printer or computer will occur each time the Print button is pressed unless autoprint feature is turned on in which case printing can occur in a continuous fashion, at specified intervals or each time a stable reading is achieved.

Sample printout is shown below with time turned on.

SAMPLE PRINTOUT

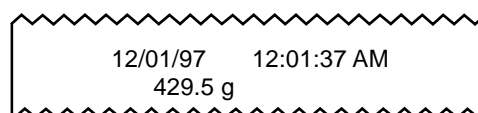

For a review of of printing samples, refer to Section 4 Setting Up Your Balance. What is printed is controlled by the GLP Set Menu and the selection of GLP Cont. or GLP Tare in the Print Menu.

4. SETTING UP YOUR BALANCE

4.1 Setting Date and Time

Your Explorer balance provides date and time data which can be viewed on a computer or printed out on an external printer. When you put your new instrument into operation for the first time, you should enter the current date and the time. These settings are retained as long as the balance remains connected to a power source.

Date

Date is a feature which enables the balance to be set to a U.S.A. date standard or European date standard. U.S. standard has the month, date, followed by the year, each separated by (/) in the printout. The European date standard has the day first, followed by the month and then the year; each separated by a period. The default setting is **U.S.A. Standard**.

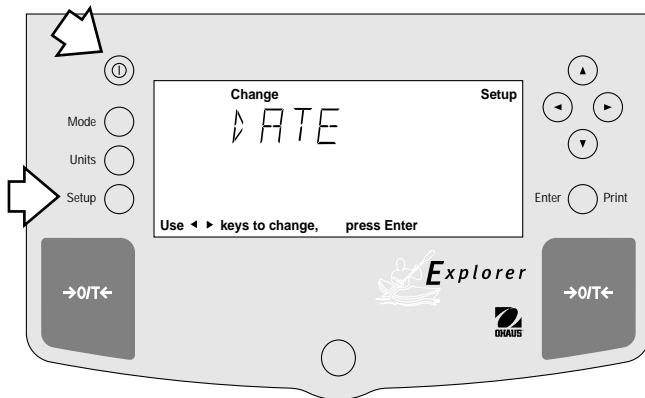

Procedure

- Press the **Setup** button, CAL is displayed.
- Press ◀ or ▶ button and select Date from the menu.
- Press **Enter** button, TYPE is displayed.
- Press **Enter** button, SET M d y, d M y, y M d, M y d, y d M, or d y M is displayed.
- Press ▲ or ▼ button and select type of date.
- Press **Enter** button, SAVED is displayed, then SET is displayed.
- Press **Enter** button, first digit of date is flashing.
- Using arrow buttons, enter the correct date.
- When the correct date is entered, press **Enter** button, SAVED displays momentarily and EXIT appears.
- Press **Enter** button, balance returns to a weighing mode.

Time

Time is a feature which enables the balance to be set to the current time in either U.S.A. standards (12 hour periods) or European/Military standards (24 hour periods). The default setting is **U.S.A. Standard**.

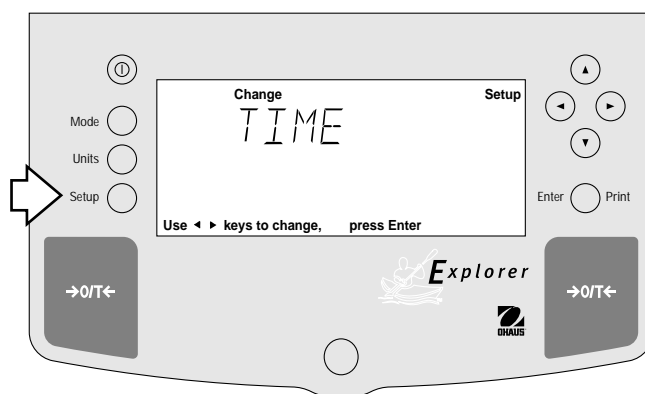

Procedure

- Press the **Setup** button, CAL is displayed.
- Press ◀ or ▶ button and select Time from the menu.
- Press **Enter** button, TYPE is displayed.
- Press **Enter** button, TYPE 12 hr is displayed.
- Press ▲ or ▼ button and select 12 hr or 24 hr.
- Press **Enter** button, SAVED is displayed momentarily then SET is displayed.
- Press **Enter** button, SET with time is flashing.
- Using arrow buttons, enter the correct time.
- When the correct time is entered, press **Enter** button, SAVED displays momentarily and EXIT appears.
- Press **Enter** button, balance returns to a weighing mode.

Adjustments up to ± 60 seconds a month can be made to the balance internal clock. Repeat the first seven steps, ADJUST is displayed. Using arrow buttons, enter time correction and press **Enter** button.

4.2 Readout

The Readout menu is used to adapt the balance to environmental conditions. It contains four submenus: **Stable**, **Auto 0**, **Filter**, **Lock** and **Exit**. Lock enables you to program balance parameters and to lock the settings.

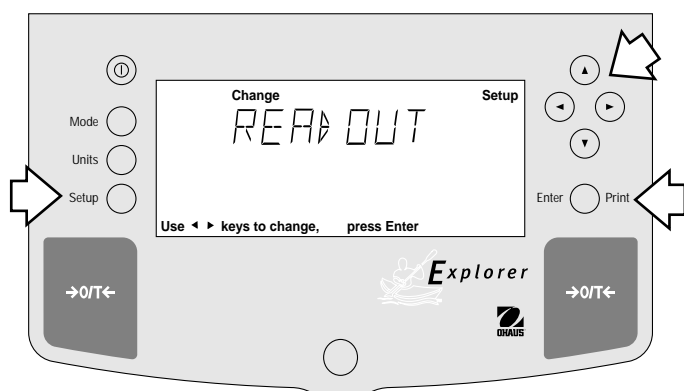

Procedure

To select any of the items in the Readout menu, proceed as follows:

- Press the **Setup** button, CAL is displayed.
- Press ◀ or ▶ button until READOUT is displayed.
- Press **Enter** button to save setting.
- Press ◀ or ▶ button until either STABLE, AUTO 0, FILTER, LOCK or EXIT is displayed.
- Press **Enter** button to save setting.
- Press ▲ or ▼ button and select the desired menu setting.
- Press **Enter** button SAVED is displayed.
- Press ◀ or ▶ button to continue or EXIT.
- Press **Enter** button to save setting.

Stability

The stability range specifies the weighing results and must be within a preset tolerance limit for a certain time to turn the stability indicator ON. When a displayed weight changes beyond the allowable range, the stability indicator turns OFF, indicating an unstable condition. Factory default setting is shown in bold type.

- .5 d Smallest range: stability indicator is ON only when displayed weight is stable within .5 divisions.
- 1 d Reduced range.**
- 2 d Normal range.
- 5 d Largest range, stability indicator is ON even though displayed weight changes slightly.

When the RS232 interface is configured to print stable data only, the stability range also governs data output. Displayed data will only be output if it is within the selected stability range.

Auto-Zero

Auto-Zero minimizes the effects of temperature changes and shift on the zero reading. The balance maintains the zero display until the threshold is exceeded. Factory default setting is shown in bold type.

- OFF Turns Auto-Zero OFF.
- .5 d Sets threshold to .5 divisions.
- 1 d Sets threshold to 1 division.**
- 3 d Sets threshold to 3 divisions.

Filter

Filter compensates for vibration or excessive air currents. Default settings are shown bold.

- 0- reduced stability, fastest stabilization time
- 1- normal stability, normal stabilization time
- 2- more stability, slow stabilization time.**
- 3- maximum stability, slowest stabilization time.

Lock

Lock ON/OFF can only be changed when the hardware Lock Switch is set OFF/disabled. A menu is locked when the menu lock is set ON and the Lock switch is ON. Lock when selected and turned on, locks all of the entries made under the Readout menu. In the locked condition, items may be looked at but not changed in the menu. When set off, entries may be changed. **OFF** is the default setting.

4.3 Good Laboratory Practices (GLP) Data

The GLP Data submenu enables the storage of a user identification number (7 digits) and/or a project number (digits). When entered into the balance, the identification number and project number are available when printing providing they are turned on in the GLP Set submenu. A lock setting is also available which locks in the user identification and project number.

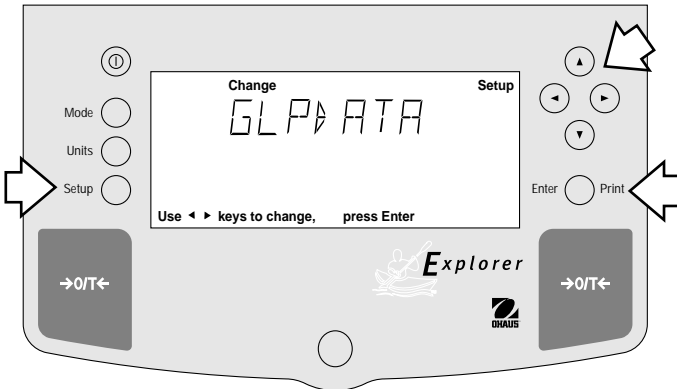

Procedure

To select any of the items in the GLP Data menu, proceed as follows:

- Press the **Setup** button, CAL is displayed.
- Press ◀ or ▶ button until GLP DATA is displayed.
- Press **Enter** button to continue.
- Press ◀ or ▶ button until either USER NO, PROJ NO, LOCK or EXIT is displayed.
- Press **Enter** button to continue.
- Press ◀ ▶ or ▲ ▼ buttons as directed by the display and enter a 7 digit number for the user ID number.
- Press **Enter** button to save setting.
- Press ◀ or ▶ button until either USER NO, PROJ NO, LOCK or EXIT is displayed.
- Press **Enter** button to continue.
- Press ◀ ▶ or ▲ ▼ buttons as directed by the display and enter a 7 digit number for the project number.
- Press **Enter** button to save setting.
- Press ◀ or ▶ button to select next item or EXIT.
- Press **Enter** button to continue.

4.4 Good Laboratory Practices (GLP) Set

Good Laboratory Practices (GLP) Set submenu allows the selection and will permit printing of Time, Balance Identification Number, User Identification Number, Project Number, Difference and Name data to be printed. When the selected items are set to ON, these items are not displayed. The default setting is OFF. When an external printer is used, and all items are set ON and the balance is calibrated, the printer will print out calibration data for audit trail purposes and will indicate date, and time. (It should be noted that the User ID number and Project number must be entered in the GLP Data submenu before printed data is available).

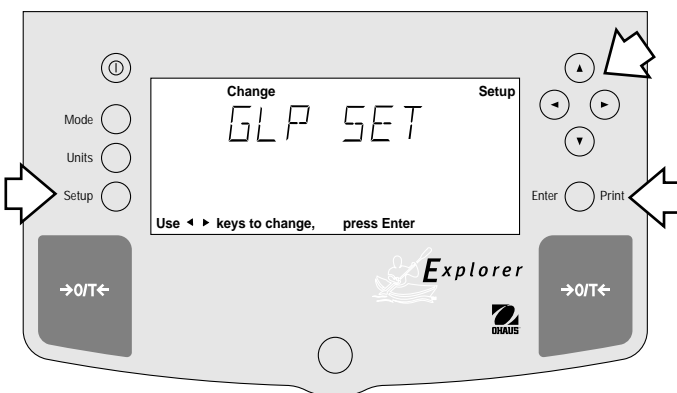

Procedure

To select any of the items in the GLP Set menu, proceed as follows:

- Press the **Setup** button, CAL is displayed.
- Press ◀ or ▶ button until GLP SET is displayed.
- Press **Enter** button to save setting.
- Press ◀ or ▶ button until either TIME, BAL ID, USER NO, PROJ NO, DIFF, NAME, LOCK or EXIT is displayed.
- Press **Enter** button to save setting.
- Press ▲ or ▼ button and select either ON or OFF.
- Press **Enter** button to save setting.
- Press ◀ or ▶ button to continue or EXIT.
- Press **Enter** button to save setting.

4.5 Print

The Print menu provides a number of options which can be turned ON or OFF. It contains eight submenus: **Auto Print**, feature which includes selection of Off, Continuous, Interval and on Stability, **Inter**, specifies time interval for automatic output of displayed data, **Stable** data-only feature, **Numeric** only or full display data for output, **GLPCont**, **GLPTare**, **Reference** which prints reference weight value and **Lock** which enable you to program balance parameters and to lock the settings.

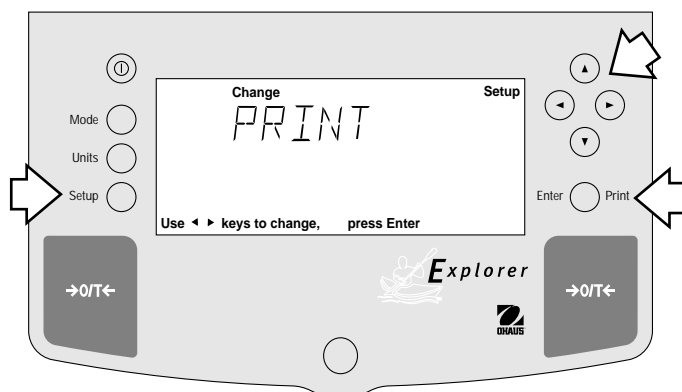

Procedure

- Press the **Setup** button, CAL is displayed.
- Press ◀ or ▶ button until PRINT is displayed.
- Press **Enter** button to continue.
- Press ◀ or ▶ button until either AUTOPRT, INTER, STABLE, NUMERIC, GLPCONT, GLPTARE, REFEREN, LOCK or EXIT is displayed.
- Press **Enter** button to continue.
- Press ▲ or ▼ button and select either menu setting or ON or OFF.
- Press **Enter** button to save setting.
- Press ◀ or ▶ button to select next item or EXIT.
- Press **Enter** button to continue.

Auto Print Feature

When enabled, the Auto Print feature causes the balance to automatically output display data in one of three ways: continuously, at user specified time intervals, or upon stability. Default settings are shown bold.

| | |
|------------|--|
| OFF | when set on turns off the auto print feature |
| Cont | when set on, outputs printed data continuously |
| Inter | provides a user specified printing interval |
| On Stb | provides printed data only when a stable reading is achieved |

Interval

Can be set to provide a specified printing interval between 1 and 3600 seconds.

Print Stable Data Only

When set On, this feature permits only stable display data to be output. **OFF** is the default setting.

Print Numeric Data Only

When Numeric Data Only function is turned ON, this allows the balance to output numeric data only for RS232 output. **OFF** is the default setting.

4.5 Print (Cont.)

GLP Continuously

When the GLP Continuously function is set ON, allows the balance to output the GLP selections each time a weight value is printed to the printer. **OFF** is the default setting. The following example is with GLP Cont On.

Sample Printout

```

12/01/97  12:01:37 AM
  429.5 g

12/01/97  12:01:52 AM
Bal Id
  429.8 g

12/01/97  12:02:17 AM
Bal Id
USER NO 1000001
  429.8 g

12/01/97  12:02:43 AM
Bal Id
USER NO 1000001
PROJ NO 2000002
  429.5 g

12/01/97  12:02:43 AM
Bal Id
USER NO 1000001
PROJ NO 2000002
Name .....
  429.5 g
  
```

GLP Set Menu
Options Turned On

```

Time = On

Time = On
Balance ID = On

Time = On
Bal ID = On
User No. = On

Time = On
Bal ID = On
User No = On
Proj No = On

Time = On
Bal ID = On
User No = On
Proj No =
Name = On
  
```

GLP Once After Tare

When the GLP Tare function is set ON, allows the balance to output the GLP selections once after tare when the weight value is printed to the printer. **OFF** is the default setting. The following example is with GLP Once After Tare.

```

12/01/97  12:01:37 AM
  429.5 g
  429.6 g
  429.7 g
  429.7 g
  429.7 g
  
```

GLP Set Menu
Options Turned On

```

Time = On
  
```

Reference

When the Reference function is set ON, prints the value of weight used as a reference in either Percent and Parts Counting modes. **OFF** is the default setting.

Lock

Lock ON/OFF can only be changed when the hardware Lock Switch is set OFF/unlocked. A menu is locked when the menu lock is set ON and the Lock Switch is ON. Lock when selected and turned on, locks all of the entries made under the Print menu. In the locked condition, items may be looked at but not changed in the menu. When set off, entries may be changed. **OFF** is the default setting.

4.6 RS232

The RS232 menu provides communication parameters which can be set to accommodate external printers or computers. It contains five submenus: **Baud** rate, **Parity**, **Data**, **Stop** bit and **Lock** ON or OFF which enable you to program balance parameters and to lock the settings.

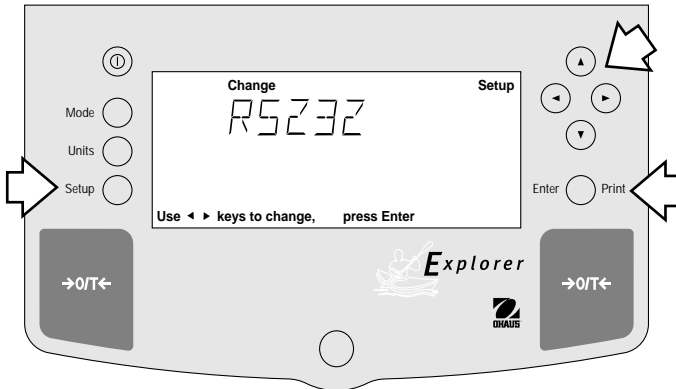

Procedure

- Press the **Setup** button, CAL is displayed.
- Press ◀ or ▶ button until RS232 is displayed.
- Press **Enter** button to save setting.
- Press ◀ or ▶ button until either BAUD, PARITY, DATA, STOP, LOCK or EXIT is displayed.
- Press **Enter** button to save setting.
- Press ▲ or ▼ button and select the desired menu setting.

Baud Rate

This submenu is used to select the desired baud rate. There are five available baud rates to choose from: 300, 1200, 2400, 4800 and 9600. The default setting is **2400**.

Parity

Parity can be set to Odd, Even or None. The default setting is **None**.

Data Bits

To set the number of data bits to 7 or 8. The default setting is **7**.

Stop Bits

The number of stop bits can be set to 1 or 2. The default setting is **2**.

Lock

Lock ON/OFF can only be changed when the hardware Lock Switch is set OFF/disabled. A menu is locked when the menu lock is set ON and the Lock Switch is ON. Lock when selected and turned on, locks all of the entries made under the RS232 menu. In the locked condition, items may be looked at but not changed in the menu. When set off, entries may be changed. **OFF** is the default setting.

4.7 Legal for Trade (LFT)

Legal for Trade (LFT) is a software controlled option which can be set to LFT NET and LFT LOCK. When set to LFT NET, the balance will indicate a NET weight during legal for trade operation. When LFT LOCK is set ON, certain items in the Calibration, Readout, Print, Mode and Units menus are automatically preset and locked to permit the balance to operate in a legal for trade application and works in conjunction with a Lock Switch. Default setting is UNLOCKED. See default table.

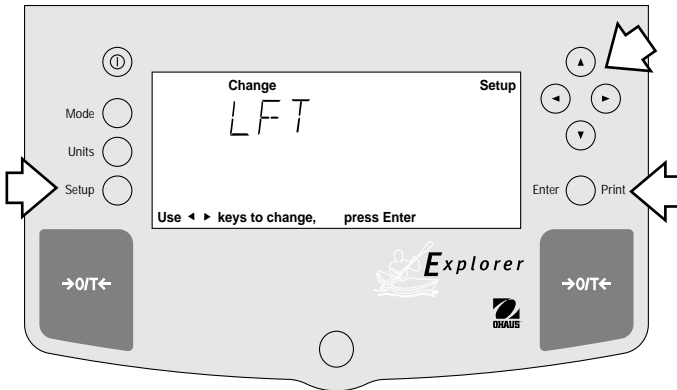

DEFAULT TABLE

| LFT and Lock Switch | Menu lock | Default Value |
|-----------------------|-------------------|-----------------------------|
| Date Menu | Unlocked | |
| Time Menu | Unlocked | |
| Calibration Menu | | |
| Span, Linearity, User | Locked | |
| CalTest | Unlocked | |
| Internal Calibration | Unlocked | |
| Cal Adj | Locked | |
| Cal Msg | Locked ON | |
| Readout Menu | | |
| Stability | Unlocked | 1d (limited to .5d and 1d) |
| Auto zero | Unlocked | 1d (limited to OFF and .5d) |
| Filter Level | Unlocked | -2- |
| GLP Data Menu | Unlocked | |
| GLP Selections | Unlocked | |
| Print Options | Unlocked | |
| RS232 Menu | Unlocked | |
| LFT Menu | Lockswitch Locked | |
| Function menu | Locked | Weigh |
| Units Menu | Locked | Grams* |
| Global Menu | Locked | |
| Custom Menu | Unlocked | |

* Units oz and oz t cannot be simultaneously enabled.

If Print Numeric Data is turned ON, then Print Stable Data Only is locked ON.

The display check countdown appears during the first 120 seconds after plugging in the balance and only when the balance has been previously set with Type Approved/Legal for Trade ON.

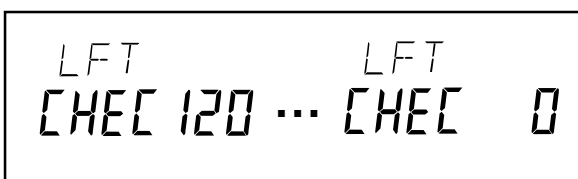

Procedure

- Press the **Setup** button, CAL is displayed.
- Press **▶** button repeatedly until LFT is displayed.
- Press **Enter** button, LFT NET is displayed.
- Press **Enter** button, LFT NET OFF is displayed.
- Press **▲** or **▼** button and select either ON or OFF.
- Press **Enter** button, SAVED is momentarily displayed, then LFT LOCK is displayed.
- Press **Enter** button, LFT LOCK OFF is displayed.
- Press **▲** or **▼** button and select either ON or OFF.
- Press **Enter** button, SAVED is momentarily displayed followed by EXIT.
- Press **Enter** button, balance returns to weigh mode.

NOTE: For legal for trade applications, the balance must be physically sealed. Refer to section on LFT Sealing.

When the balance is first turned ON and LFT has been previously set ON, the following display will appear if LFT is set in the menu and the Lock Switch is set ON.



When the balance is first turned ON and LFT has been previously set ON, the following display will appear if LFT is set in the menu and Calibration menu is locked, and the Lock Switch is set ON.



When LFT NET and LFT LOCK are both turned ON, the weigh mode display appears as shown below.

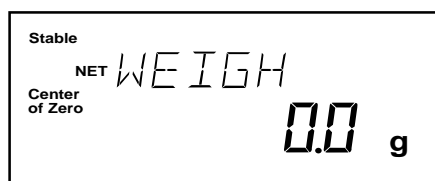

4.8 Mode

The Mode submenu permits the selection of five modes which can be turned ON or OFF. These modes are: **Weigh**, **Percent**, **Count**, **Animal** and **Lock**. Weigh is turned ON and all others have a default setting of **OFF**. When any of the modes are turned ON, they can be selected for operation from the Mode button.

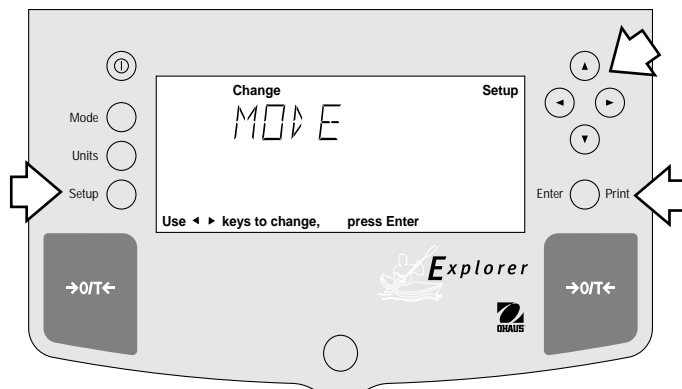

Procedure

- Press the **Setup** button, CAL is displayed.
- Press ◀ or ▶ button until MODE is displayed.
- Press **Enter** button to save setting.
- Press ◀ or ▶ button until either WEIGH, PERCENT, COUNT, ANIMAL, LOCK or EXIT is displayed.
- Press **Enter** button to save setting.
- Press ▲ or ▼ button and select either ON or OFF.
- Press **Enter** button to save setting.

Weigh

The Weigh submenu is always set to **ON** as a default.

Percent

Percent weighing permits you to place a reference load on the balance, then view other loads as a percentage of the reference. Selection is made using the **Mode** button. The default setting is **OFF**.

Count

Counting is used when counting quantities of parts. Selection is made using the **Mode** button. The default setting is **OFF**.

Animal

Animal weighing provides special settings to accommodate animal movements. Selection is made using the **Mode** button. The default setting is **OFF**.

Lock

Lock ON/OFF can only be changed when the hardware Lock Switch is set OFF/disabled. A menu is locked when the menu lock is set ON and the Lock Switch is ON. Lock when selected and turned on, locks all of the entries made under the Mode menu. In the locked condition, items may be looked at but not changed in the menu. When set off, entries may be changed. **OFF** is the default setting.

4.9 Units

The Units submenu permits the selection of the measuring units which can be turned ON or OFF and locked.

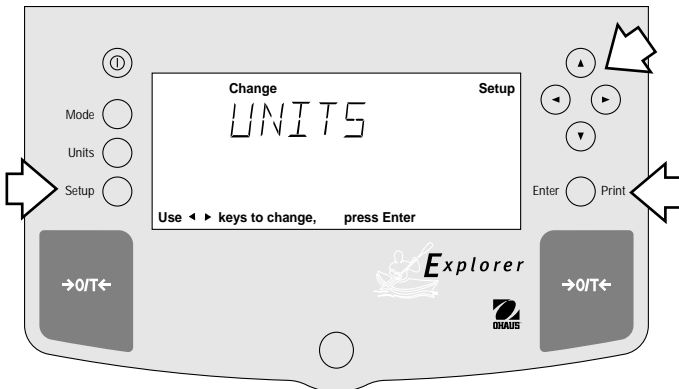

Procedure

- Press the **Setup** button, CAL is displayed.
- Press ◀ or ▶ button until UNITS is displayed.
- Press **Enter** button to continue.
- Press ◀ or ▶ button until desired measuring unit is displayed.
- Press **Enter** button to continue.
- Press ▲ or ▼ button and select either ON or OFF.
- Press **Enter** button to save setting.
- Press ◀ or ▶ button to select next item or EXIT.
- Press **Enter** button to continue.

Units

Measuring units settings are made using the Units button. This menu permits the measuring units to be turned ON or OFF. The default setting is **OFF**.

Lock

Lock when selected and turned on, locks all of the entries made under the Units button. The default setting is **OFF**.

4.10 Global

This menu contains two functions which can be set to either a yes or no type of operation. These functions are: **List**, and **Reset**. The default settings are **NO**. Global List is a convenient method of examining which parameters are set up in the balance. The parameters do not show up on the display but print out when selected. The Global menu contains the List function. When Version is selected, the software revision of the balance is displayed.

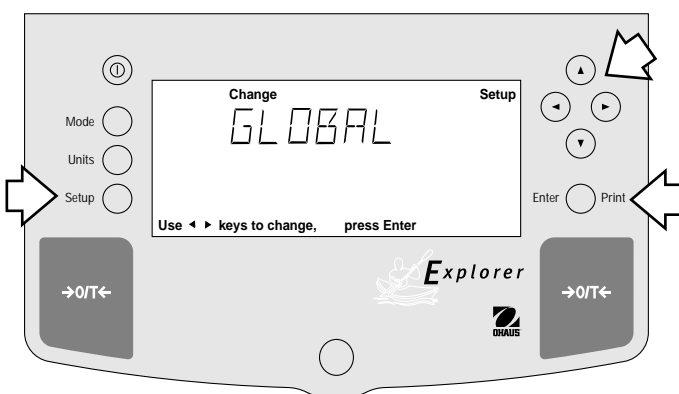

Procedure

- Press the **Setup** button.
- Press ◀ or ▶ button until GLOBAL is displayed.
- Press **Enter** button to continue.
- Press ◀ or ▶ button until either LIST, RESET, VERSION, LOCK or EXIT is displayed.
- Press **Enter** button to continue.
- Press ▲ or ▼ button and select either YES or NO for LIST and RESET. When either LOCK or EXIT is selected, ON or OFF settings are available..
- Press **Enter** button to save setting.
- Press ◀ or ▶ button to select next item or **EXIT**.
- Press **Enter** button to save.

4.10 Global (Cont.)

List

This submenu can be used to output a listing of current menu settings via the RS232 interface. When YES is selected, all menu settings will be output either to an external printer or computer. To use this feature, your balance must be connected to a computer or printer. The default setting is **OFF**.

SAMPLE PRINTOUTS

```

EXPLORESR xxxxxx-xxx
Sr #x.xx OS#x.xx G#x.xx

Time= 12hr   3:19:51 PM
Date= m/d/y  12/01/97
Function = Weigh
ReadOut Menu
  Stb= 2 d
  AZT= .5 d
  Filter= 1
GLP Menu
  Time/Date= On
  Bal Id= On
  User No.= On
  Proj No.= On
  DIFF= On
  Name= On
Print Menu
  Auto Print= Off
  Interval= 7
  Stable Print= On
  NU= On
  GLP Cont = Off
  GLP on Tare = Off
  Print Ref= On
RS232 = 2400: N: 7: 2
  
```



The partial sample shown, indicates the status in the menus.

```

LFT is Off
Mode Menu
  WEIGH= On
  PERCENT= Off
  COUNT= Off
  ANIMAL= Off
Lock Switch is Off
Menu Locks
  RS232= Off
  READOUT= Off
  GLPSET= Off
  MODE= Off
  UNITS= Off
  PRINT= Off
  GLP Data = Off
  CAL= Off
  GLOBAL= Off
  CUSTOM= Off
Enabled Units:
  g
  custm
C. Units:
  1.000000 E0 x 1
  
```

Reset

Reset when set to YES will reset the balance to factory default settings. The default setting is **NO**.

Version

Displays software revision number for servicing purposes. This number is installed with the balance.

Lock

Lock when selected and set to ON, locks all of the entries made under the Global menu. The default setting is **OFF**.

4.11 Custom Unit

Custom Unit is enabled when Custom Unit Setup under Units Menu is turned ON. This feature can be used to create your own custom weighing unit. It permits entering a conversion factor which the balance will use to convert grams to the desired unit of measure.

$$\begin{array}{r} \text{Conversion} \\ \text{Factor} \end{array} \times \begin{array}{r} \text{Weight} \\ \text{in} \\ \text{grams} \end{array} = \begin{array}{r} \text{Weight} \\ \text{in} \\ \text{custom unit} \end{array}$$

Conversion factors are expressed in scientific notation and entered into the balance in three parts:



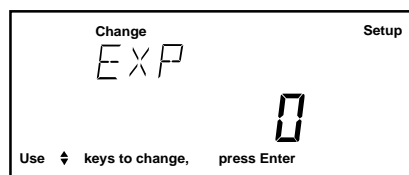
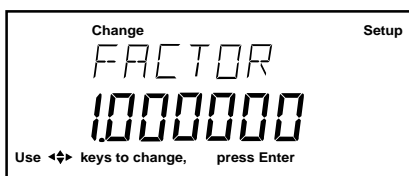
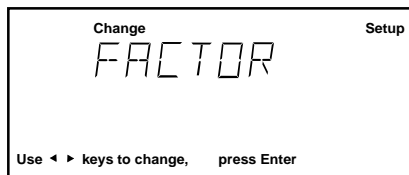
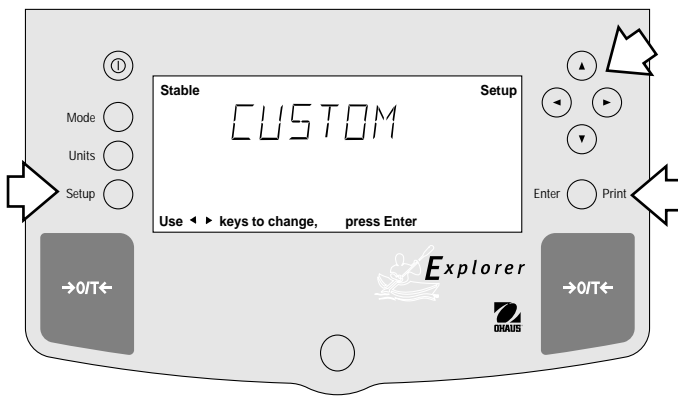





- a number between 0.1 and 1.999999 called the mantissa
- a power of 10 called the exponent
- a least significant digit (LSD)



| SCIENTIFIC NOTATION | | | | |
|---------------------|---------------------------------|-------------|----------|--------------------|
| Conv. Factor | Number Between 0.1 and 1.999999 | Power of 10 | Mantissa | Exp. |
| 123.4 | = .1234 | x 1000 | = .1234 | x 10 ³ |
| 12.34 | = .1234 | x 100 | = .1234 | x 10 ² |
| 1.234 | = .1234 | x 10 | = .1234 | x 10 ¹ |
| .1234 | = .1234 | x 1 | = .1234 | x 10 ⁰ |
| .01234 | = .1234 | x .1 | = .1234 | x 10 ⁻¹ |
| .001234 | = .1234 | x .01 | = .1234 | x 10 ⁻² |
| .000123 | = .123 | x .001 | = .123 | x 10 ⁻³ |

| EXPONENTS | |
|-----------|---|
| E-3 | Moves decimal point 3 places to the left. |
| E-2 | Moves decimal point 2 places to the left. |
| E-1 | Moves decimal point 1 place to the left. |
| E0 | Leaves decimal point in normal position. |
| E1 | Moves decimal point 1 place to the right. |
| E2 | Moves decimal point 2 places to the right. |
| E3 | Moves decimal point 3 places to the right. |

Procedure



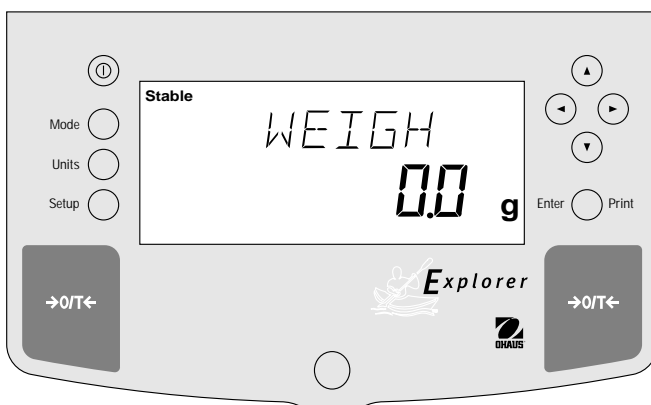
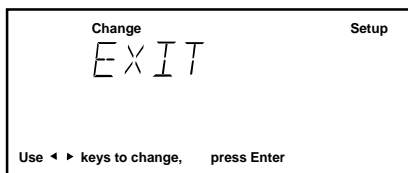
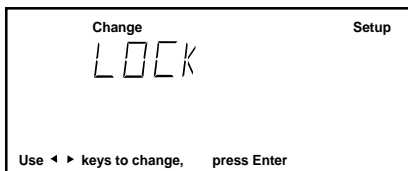
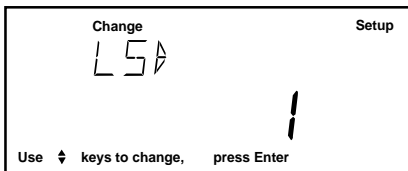
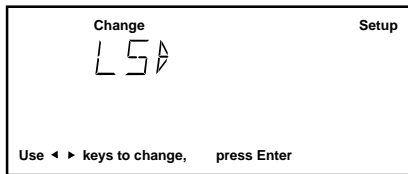

- Press the **Setup** button.
- Press  or  button until CUSTOM is displayed.
- Press **Enter** button to save setting, FACTOR is displayed.
- Press **Enter** button, The mantissa of the current conversion is displayed. The mantissa of the current conversion factor is displayed. This is a number between 0.1 and 1.999999 with the first digit flashing. For conversion factors outside of this range, the exponent will be used to move the decimal point.
- Press   or   buttons as directed by the display and enter a 7 digit number for the conversion factor.
- Press **Enter** button, EXP (exponent) is displayed.
- Press **Enter** button, 0 (exponent) is displayed.
- Press  or  button and select exponent value either -3, -2, -1, 0, 1, 2, or 3.

4.11 Custom Unit (Cont.)



| LSD's | |
|--|---|
| LSD .5 | Adds one decimal place display counts by 5's. |
| LSD 1 | Display counts by 1's. |
| LSD 2 | Display counts by 2's. |
| LSD 5 | Display counts by 5's. |
| LSD 10 | Display counts by 10's. |
| LSD 100 | Display counts by 100's. |
| * Sensitivity to vibration is increased with this LSD setting. | |

Procedure (Cont.)

- Press **Enter** button to save setting, LSD is displayed. There are 6 LSD (least significant digit) settings you can choose from (see table).
- Press **Enter** button, LSD 1 is displayed.
- Press  or  button and select LSD value either 1, 2, 5, 10 or 100.
- Press **Enter** button, SAVED is momentary displayed followed by LOCK.
- Press  or  button and select ON or OFF.
- Press **Enter** button, EXIT is displayed.
- Press **Enter** button to return to weighing mode.

4.12 Menu Lock-Out Protection

Access to the various menus can be disabled setting the Lock Switch located on the PC board inside the balance to OFF position. The Lock Switch locks out all menus which have had LOCK turned ON. The default setting for the Lock Switch is OFF.

Type Approved/Legal for Trade Balance Sealing

“Certified balances have a securing sticker applied at the factory. When subsequent verification is carried out, they can be sealed either with a lead seal and wire, or with a new securing sticker”.

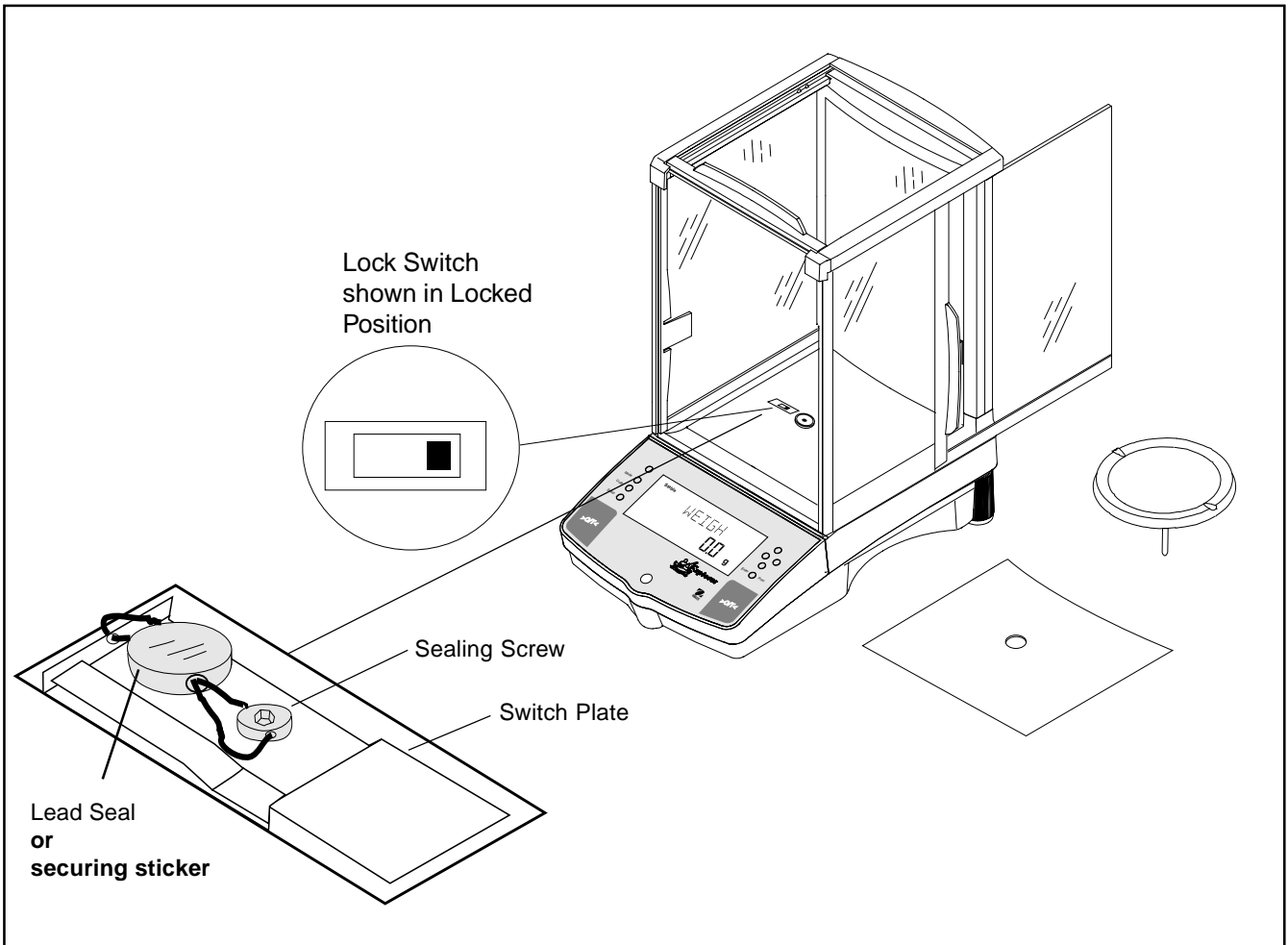

Example of Sealing Method

5 CARE AND MAINTENANCE

To keep the balance operating properly, the housing and platform should be kept clean and free from foreign material. If necessary, a cloth dampened with a mild detergent may be used. Keep calibration masses in a safe dry place.

5.1 Troubleshooting

| SYMPTOM | PROBABLE CAUSE(S) | REMEDY |
|--|--|---|
| Unit will not turn on. | Power cord not plugged in or properly connected to balance. | Check power cord connections. |
| Incorrect weight reading. | Balance was not re-zeroed before weighing. Balance not properly calibrated. | Press # with no weight on the pan, then weigh item. Recalibrate correctly. |
| Cannot display weight in desired unit. | Desired unit not enabled. | Press Units button until desired measuring unit is shown. Enable units in Setup menu. |
| Unable to store menu settings/ changes. | Enter was not selected. Menu locked. | Press Enter when prompted. Menu not locked properly. |
| RS232 interface not working. | Print menu settings not properly set up. Cable connections. | Verify interface settings in RS232 menu correspond to those of peripheral device. Check cable connections. |
| Random segments displayed or display locks up. | Microprocessor locks up. | Turn power off, then turn on again. If condition persists, unit must be serviced. |
| Unable to change settings. | Menu locked (Lock Switch set ON) | Set menu Lock OFF. Set Lock Switch to OFF. |
| Unstable readings. | Excessive air currents. Vibration on table surface. | Check environmental conditions. Place balance on a stable surface or change averaging level. |
| Error message display. | _____ | See Error Codes list. |
| Cannot access weighing mode. | Desired weighing mode is not enabled. | Press mode until desired weighing mode is displayed. Enable weighing mode. |

5.2 RS232 Interface

Explorer balances are equipped with a bidirectional RS232 compatible interface for communication with printers and computers. When the balance is connected directly to a printer, displayed data can be output at any time by simply pressing PRINT, or by using the Auto Print feature.

Connecting the balance to a computer enables you to operate the balance from the computer, as well as receive data such as displayed weight, weighing mode, stability status, etc.

The following sections describe the hardware and software provided with the balance

Hardware

On the rear of the balance, the right-hand, 9-pin male subminiature "D" connector is provided for interfacing to other devices. The pinout and pin connections are shown in the adjacent illustration.

The balance will not output any data unless pin 5 (CTS) is held in an ON state (+3 to +15 V dc). Interfaces not utilizing the CTS handshake may tie pin 5 to pin 6 to defeat it.

Output Formats

Data output can be initiated in one of three ways: 1) By pressing PRINT; 2) Using the Auto Print feature; 3) Sending a print command ("P") from a computer.

The output format is illustrated in the RS232 command table which follows.

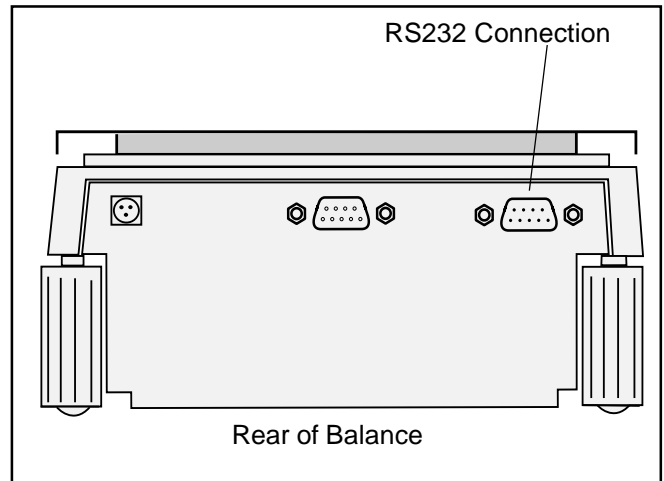

RS232 Commands

All communication is accomplished using standard ASCII format. Characters shown in the following table are acknowledged by the balance. Invalid command response "ES" error indicates the balance has not recognized the command. Commands sent to the balance must be terminated with a carriage return (CR) or carriage return-line line feed (CRLF). For example, a tare command should appear as shown in the adjacent diagram. Data output by the balance is always terminated with a carriage return - line feed (CRLF).

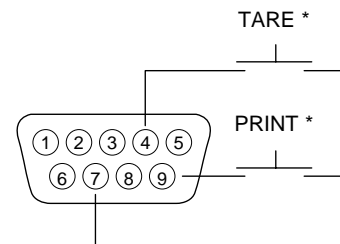

RS232 COMMAND TABLE

| Command Character | Description | | | | | | | | | | | | | | | | | | | | | | | | | | | | | | | |
|-------------------|---|---------|-------------------|---------|---------------------|---------|----------------------|---------------|--------------------------|---|---|----|----|---|---|------|-------|----|------|-------|-----|------|-----|----|-------|---|----|----|--|------|--|--|
| ? | Print current mode | | | | | | | | | | | | | | | | | | | | | | | | | | | | | | | |
| | <table border="1"> <tr> <td>Field:</td> <td>Mode</td> <td>Stab</td> <td>CR</td> <td>LF</td> </tr> <tr> <td>Length:</td> <td>5</td> <td>1</td> <td>1</td> <td>1</td> </tr> </table> <p style="text-align: right;">blank if stable " ? " if unstable</p> <table border="1"> <tr> <td>mg</td> <td>GN</td> <td>N</td> </tr> <tr> <td>g</td> <td>tael</td> <td>tical</td> </tr> <tr> <td>kg</td> <td>tael</td> <td>custm</td> </tr> <tr> <td>dwt</td> <td>tael</td> <td>Pcs</td> </tr> <tr> <td>ct</td> <td>momme</td> <td>%</td> </tr> <tr> <td>oz</td> <td>lb</td> <td></td> </tr> <tr> <td>oz t</td> <td></td> <td></td> </tr> </table> | Field: | Mode | Stab | CR | LF | Length: | 5 | 1 | 1 | 1 | mg | GN | N | g | tael | tical | kg | tael | custm | dwt | tael | Pcs | ct | momme | % | oz | lb | | oz t | | |
| Field: | Mode | Stab | CR | LF | | | | | | | | | | | | | | | | | | | | | | | | | | | | |
| Length: | 5 | 1 | 1 | 1 | | | | | | | | | | | | | | | | | | | | | | | | | | | | |
| mg | GN | N | | | | | | | | | | | | | | | | | | | | | | | | | | | | | | |
| g | tael | tical | | | | | | | | | | | | | | | | | | | | | | | | | | | | | | |
| kg | tael | custm | | | | | | | | | | | | | | | | | | | | | | | | | | | | | | |
| dwt | tael | Pcs | | | | | | | | | | | | | | | | | | | | | | | | | | | | | | |
| ct | momme | % | | | | | | | | | | | | | | | | | | | | | | | | | | | | | | |
| oz | lb | | | | | | | | | | | | | | | | | | | | | | | | | | | | | | | |
| oz t | | | | | | | | | | | | | | | | | | | | | | | | | | | | | | | | |
| nnnnA | Set Auto Print feature to "nnnn" (see table). | | | | | | | | | | | | | | | | | | | | | | | | | | | | | | | |
| | <table border="1"> <tr> <td>nnn = 0</td> <td>Turns feature OFF</td> </tr> <tr> <td>nnn = S</td> <td>Output on stability</td> </tr> <tr> <td>nnn = C</td> <td>Output is continuous</td> </tr> <tr> <td>nnnn = 1-3600</td> <td>Sets Auto Print Interval</td> </tr> </table> | nnn = 0 | Turns feature OFF | nnn = S | Output on stability | nnn = C | Output is continuous | nnnn = 1-3600 | Sets Auto Print Interval | | | | | | | | | | | | | | | | | | | | | | | |
| nnn = 0 | Turns feature OFF | | | | | | | | | | | | | | | | | | | | | | | | | | | | | | | |
| nnn = S | Output on stability | | | | | | | | | | | | | | | | | | | | | | | | | | | | | | | |
| nnn = C | Output is continuous | | | | | | | | | | | | | | | | | | | | | | | | | | | | | | | |
| nnnn = 1-3600 | Sets Auto Print Interval | | | | | | | | | | | | | | | | | | | | | | | | | | | | | | | |

| | |
|----|---------------------------|
| 1 | N/C |
| 2 | Data Out (TXD) |
| 3 | Data In (RXD) |
| 4* | Tare (External signal) |
| 5 | Clear To Send (CTS) |
| 6 | Data Terminal Ready (DTR) |
| 7 | Ground |
| 8 | Request To Send (RTS) |
| 9* | Print (External signal) |

* External PRINT and/or TARE switches may be installed as shown in the diagram. Momentary contact switches must be used.

RS232 COMMAND TABLE (Cont.)

| Command Character | Description | | | | | | | | | | | | | | | | | | | | | | | | | | | | | | | | | | | | | | | | | | | | | | | | | | | |
|-------------------|--|-----------------|--------|---------------|------|----|-------|---------|---|------------|---|---|---------------|---|---|--------|---|---|--------|---|---|-------------|---|---|--------|---|---|-----------------|----|---|-----------------|----|---|--------------|----|---|--------|----|---|----------------|----|---|------------|----|---|----------|----|---|-------|----|---|--------------|
| C | Begin span calibration | | | | | | | | | | | | | | | | | | | | | | | | | | | | | | | | | | | | | | | | | | | | | | | | | | | |
| xD | Set 1 second print delay (set x = 0 for OFF, or x = 1 for ON) | | | | | | | | | | | | | | | | | | | | | | | | | | | | | | | | | | | | | | | | | | | | | | | | | | | |
| F | Print current function. | | | | | | | | | | | | | | | | | | | | | | | | | | | | | | | | | | | | | | | | | | | | | | | | | | | |
| xI | Set Averaging Filter Level to "x", where x = 0 to 3 (see table). If LFT, level 0 to 1. <table border="1" style="float: right; margin-left: 20px;"> <tr><td>0</td><td>=</td><td>minimum level</td></tr> <tr><td>1</td><td>=</td><td></td></tr> <tr><td>2</td><td>=</td><td></td></tr> <tr><td>3</td><td>=</td><td>maximum level</td></tr> </table> | 0 | = | minimum level | 1 | = | | 2 | = | | 3 | = | maximum level | | | | | | | | | | | | | | | | | | | | | | | | | | | | | | | | | | | | | | | |
| 0 | = | minimum level | | | | | | | | | | | | | | | | | | | | | | | | | | | | | | | | | | | | | | | | | | | | | | | | | | |
| 1 | = | | | | | | | | | | | | | | | | | | | | | | | | | | | | | | | | | | | | | | | | | | | | | | | | | | | |
| 2 | = | | | | | | | | | | | | | | | | | | | | | | | | | | | | | | | | | | | | | | | | | | | | | | | | | | | |
| 3 | = | maximum level | | | | | | | | | | | | | | | | | | | | | | | | | | | | | | | | | | | | | | | | | | | | | | | | | | |
| L | Begin linearity calibration | | | | | | | | | | | | | | | | | | | | | | | | | | | | | | | | | | | | | | | | | | | | | | | | | | | |
| xM | Places balance in mode "x", where x = 1 to 17 (see table). If unit or mode is not already enabled, command will be ignored. <table border="1" style="float: right; margin-left: 20px;"> <tr><td>1</td><td>=</td><td>milligrams</td></tr> <tr><td>2</td><td>=</td><td>grams</td></tr> <tr><td>3</td><td>=</td><td>kilo grams</td></tr> <tr><td>4</td><td>=</td><td>dwt</td></tr> <tr><td>5</td><td>=</td><td>Carats</td></tr> <tr><td>6</td><td>=</td><td>Ounces</td></tr> <tr><td>7</td><td>=</td><td>Ounces troy</td></tr> <tr><td>8</td><td>=</td><td>Grains</td></tr> <tr><td>9</td><td>=</td><td>Taels Hong Kong</td></tr> <tr><td>10</td><td>=</td><td>Taels Singapore</td></tr> <tr><td>11</td><td>=</td><td>Taels Taiwan</td></tr> <tr><td>12</td><td>=</td><td>Mommes</td></tr> <tr><td>13</td><td>=</td><td>Decimal Pounds</td></tr> <tr><td>14</td><td>=</td><td>(Not used)</td></tr> <tr><td>15</td><td>=</td><td>Newton's</td></tr> <tr><td>16</td><td>=</td><td>tical</td></tr> <tr><td>17</td><td>=</td><td>Custom Units</td></tr> </table> | 1 | = | milligrams | 2 | = | grams | 3 | = | kilo grams | 4 | = | dwt | 5 | = | Carats | 6 | = | Ounces | 7 | = | Ounces troy | 8 | = | Grains | 9 | = | Taels Hong Kong | 10 | = | Taels Singapore | 11 | = | Taels Taiwan | 12 | = | Mommes | 13 | = | Decimal Pounds | 14 | = | (Not used) | 15 | = | Newton's | 16 | = | tical | 17 | = | Custom Units |
| 1 | = | milligrams | | | | | | | | | | | | | | | | | | | | | | | | | | | | | | | | | | | | | | | | | | | | | | | | | | |
| 2 | = | grams | | | | | | | | | | | | | | | | | | | | | | | | | | | | | | | | | | | | | | | | | | | | | | | | | | |
| 3 | = | kilo grams | | | | | | | | | | | | | | | | | | | | | | | | | | | | | | | | | | | | | | | | | | | | | | | | | | |
| 4 | = | dwt | | | | | | | | | | | | | | | | | | | | | | | | | | | | | | | | | | | | | | | | | | | | | | | | | | |
| 5 | = | Carats | | | | | | | | | | | | | | | | | | | | | | | | | | | | | | | | | | | | | | | | | | | | | | | | | | |
| 6 | = | Ounces | | | | | | | | | | | | | | | | | | | | | | | | | | | | | | | | | | | | | | | | | | | | | | | | | | |
| 7 | = | Ounces troy | | | | | | | | | | | | | | | | | | | | | | | | | | | | | | | | | | | | | | | | | | | | | | | | | | |
| 8 | = | Grains | | | | | | | | | | | | | | | | | | | | | | | | | | | | | | | | | | | | | | | | | | | | | | | | | | |
| 9 | = | Taels Hong Kong | | | | | | | | | | | | | | | | | | | | | | | | | | | | | | | | | | | | | | | | | | | | | | | | | | |
| 10 | = | Taels Singapore | | | | | | | | | | | | | | | | | | | | | | | | | | | | | | | | | | | | | | | | | | | | | | | | | | |
| 11 | = | Taels Taiwan | | | | | | | | | | | | | | | | | | | | | | | | | | | | | | | | | | | | | | | | | | | | | | | | | | |
| 12 | = | Mommes | | | | | | | | | | | | | | | | | | | | | | | | | | | | | | | | | | | | | | | | | | | | | | | | | | |
| 13 | = | Decimal Pounds | | | | | | | | | | | | | | | | | | | | | | | | | | | | | | | | | | | | | | | | | | | | | | | | | | |
| 14 | = | (Not used) | | | | | | | | | | | | | | | | | | | | | | | | | | | | | | | | | | | | | | | | | | | | | | | | | | |
| 15 | = | Newton's | | | | | | | | | | | | | | | | | | | | | | | | | | | | | | | | | | | | | | | | | | | | | | | | | | |
| 16 | = | tical | | | | | | | | | | | | | | | | | | | | | | | | | | | | | | | | | | | | | | | | | | | | | | | | | | |
| 17 | = | Custom Units | | | | | | | | | | | | | | | | | | | | | | | | | | | | | | | | | | | | | | | | | | | | | | | | | | |
| P | Print display data When "numeric only" data is selected for output in the RS232 menu, the Mode field is not output. <table border="1" style="float: right; margin-left: 20px;"> <tr> <td>Field:</td> <td>Weight</td> <td>Mode</td> <td>Stab</td> <td>CR</td> <td>LF</td> </tr> <tr> <td>Length:</td> <td>9</td> <td>1</td> <td>5</td> <td>1</td> <td>1</td> </tr> </table> <p style="margin-left: 100px;">Same as ? command</p> <p>Displayed weight sent right justified w/lead zero blanking. Nine characters include: decimal point (1) weight (7 max) polarity (1): blank if positive "-" if negative</p> | Field: | Weight | Mode | Stab | CR | LF | Length: | 9 | 1 | 5 | 1 | 1 | | | | | | | | | | | | | | | | | | | | | | | | | | | | | | | | | | | | | | | |
| Field: | Weight | Mode | Stab | CR | LF | | | | | | | | | | | | | | | | | | | | | | | | | | | | | | | | | | | | | | | | | | | | | | | |
| Length: | 9 | 1 | 5 | 1 | 1 | | | | | | | | | | | | | | | | | | | | | | | | | | | | | | | | | | | | | | | | | | | | | | | |
| xSL | Set stable data only printing (set x = 0 to 3). If LFT 0 or 1. | | | | | | | | | | | | | | | | | | | | | | | | | | | | | | | | | | | | | | | | | | | | | | | | | | | |
| T | Same effect as pressing O/T button. | | | | | | | | | | | | | | | | | | | | | | | | | | | | | | | | | | | | | | | | | | | | | | | | | | | |
| V | Print EPROM version | | | | | | | | | | | | | | | | | | | | | | | | | | | | | | | | | | | | | | | | | | | | | | | | | | | |
| Esc V | Print balance ID (13 characters). | | | | | | | | | | | | | | | | | | | | | | | | | | | | | | | | | | | | | | | | | | | | | | | | | | | |
| xZ | Set Auto Zero to "x", where x = 0 to 3). 0=Off, 1=0.5d, 2=1d, 3=5d.If LFT, programs Auto zero level from 0 to 1. | | | | | | | | | | | | | | | | | | | | | | | | | | | | | | | | | | | | | | | | | | | | | | | | | | | |
| x% | Set % reference function. Uses x (Real Number) as current Percent Reference. Reference weigh must be entered in grams. | | | | | | | | | | | | | | | | | | | | | | | | | | | | | | | | | | | | | | | | | | | | | | | | | | | |
| x# | Set PC reference function Uses x (Real Number) as current Percent Reference. Reference weigh must be entered in grams. | | | | | | | | | | | | | | | | | | | | | | | | | | | | | | | | | | | | | | | | | | | | | | | | | | | |

NOTE: Availability of shaded units subject to local regulations.

RS232 COMMAND TABLE (Cont.)

| Command Character | Description |
|--------------------------|---|
| Esc R | Resets Setup and Print menus to factory defaults. CAUTION: This will reset RS232 configuration. |
| ON | Turns balance on. |
| OFF | Turns balance off. |
| # | Print current Parts Count Reference Weigh. |
| % | Print current Percent Reference Weigh. |
| xF | Set current function, set x for 0=None (normal weigh), 1=percent, 2=parts Counting, 3=Animal Weighing. None |
| xAW | Set Animal Level from 0 to 3. 0= least amount of filtering. |
| xE | Set/Reset Auto Restart in Animal mode. Where x is 0=Off and 1=ON. |
| E | Start Animal cycle. |
| xT | Download tare, tare weight must be entered in grams. |
| ID | Print Current User ID String. |
| xID | Program User ID String, 1-8 characters. |
| AC | Abort Calibration. |
| xUC | User Weight Calibration. |
| IC | Internal calibration (InCAL™) |
| LE | Show Last Error Code. Response: Err: Error Number. |
| SN | Show Serial Number. |
| xS | Print Stable Only. Where x=0 Off and x=1 On. |
| TIME | Print Current Time. Note, a ? mark will follow if date or time has not been set. |
| mm/dd/yy SETDATE | Set Date Command and remove Invalid Indicator |
| hh:mm:ss SETTIME | Set Time Command and Remove Invalid Time Indicator |
| DATE | Prints Current Date. Note, a ? mark will follow the year if date or time has not been set. |
| W\$TM | Write Clock Trim Value. The clock can be adjusted by + - 60 seconds a month. |
| R\$TM | Read Clock Trim value |
| SETUP | Program Setup menu Options |
| SW | Show Lockswitch status. |

5.3 Error Codes List

Error Codes List

The following list describes the various error codes and which can appear on the display and the suggested remedy.

Data Errors

- 1.0 Transient error (hardware error, probably static discharge). If error persists, the balance must be serviced.
- 1.1 Balance temperature transducer hardware error.

Tare Errors

- 2.0 Balance is unable to stabilize within time limit after taring. Environment is too hostile or balance needs recalibration.

Calibration Errors

- 3.0 Incorrect or no calibration mass used for calibration. Recalibrate with correct masses.

RS232 Errors

- 4.4 RS232 buffer is full.

User Errors

- 7.0 User entry out of bounds.
- 7.2 Number outside of display capacity.

Over-Under Load Errors

- 8.0 Hardware error causing an internal weight signal which is too low. Check if pan is off. If not, the balance must be serviced.
- 8.1 Hardware error caused by an internal weight signal which is too high. Check load on the pan which may be excessive. If error persists, the balance must be serviced.
- 8.2 Power-on load out of specification (LFT only)
- 8.3 Rated capacity exceeded. Remove excessive weight from pan.
- 8.4 Underload condition on balance. Check that the proper pan is installed.
- 8.5 Internal calibration weight internal sensor indicated its weight on the pan.

Checksum Errors

- 9.1 Bad factory checksum. If error persists, have the balance serviced.
- 9.2 Bad factory checksum. If error persists, have the balance serviced.
- 9.3 Bad factory checksum. If error persists, have the balance serviced.
- 9.4 Factory internal calibration data failed checksum. This failure will disable access to the InCAL™ feature (if installed).
- 9.5 Factory calibration data failed checksum.
- 9.8 User calibration data failed checksum.
- 9.9 Factory temperature compensation data failed checksum.

5.4 Information Messages

- | | |
|----------------|--|
| CAL NOW | If InCAL™ (internal calibration) is installed. Message to recalibrate the balance. The message will remain until calibrated. |
| WARM UP | The user tried to perform an internal calibration and this message will be flashed in the 14 segment field. The balance requires a 7 minute warmup period. During warmup the user can not select InCAL™ from the menu. |
| SAVED | This message is flashed when an item is changed in the menu and the new value is written to the EEPROM. |
| LOCKED | This message is flashed when an item can not be changed in the menu because the menu is locked and the Lock Switch is set locked. |
| LOW REF | The message is flashed in parts counting or percent when the calculated reference weight is very low. |
| UNSTBLE | This message is flashed when the balance was unable to acquire stable data during internal calibration. |

5.5 Service Information

If the Troubleshooting section does not resolve or describe your problem, you will need to contact an authorized Ohaus Service Agent. For Service assistance in the United States, please call Aftermarket, Ohaus Corporation toll-free at (800) 526-0659. An Ohaus Product Service Specialist will be available to help you.

5.6 Replacement parts

| <u>Description</u> | <u>Ohaus Part No.</u> |
|---|-----------------------|
| Power Pack, 100/120 V ac US Plug (Cord set part of power pack) | 490202-01 |
| Power Pack, (Cord set required for UK, European and Australian) | 490203-01 |
| Cord Set, 230 V ac, UK Plug | 76448-00 |
| Cord Set, 230 V ac, European Plug | 76212-00 |
| Cord Set, 230 V ac, Australian plug | 76199-01 |

5.7 Accessories

| <u>Description</u> | <u>Ohaus Part No.</u> |
|---|-----------------------|
| Calibration Masses - ASTM Class 1 Tolerance: | |
| 20 g | 49024-11 |
| 50 g | 49054-11 |
| 100 g | 49015-11 |
| 200 g | 49025-11 |
| 500 g | 49055-11 |
| 1 kg | 49016-11 |
| 2 kg | 49026-11 |
| 4 kg | 49046-11 |
| In-Use Display Cover Kit | 470003-01 |
| Security Device | 470004-01 |
| Draftshield Kit | 470006-01 |
| Density Determination Kit | 470007-01 |
| Modular Display Upgrade Kit | 470008-01 |
| Auxilliary Display Kit | |
| (Table Mount) | 470009-01 |
| (Wall Mount) | 470009-02 |
| (Tower Mount) | 470009-03 |
| Remote Display Kit | |
| (Table Mount) | 470010-01 |
| (Wall Mount) | 470010-02 |
| (Tower Mount) | 470010-03 |
| RS232 Interface Cable, Blunt end (user defined) | AS017-01 |
| RS232 Interface Cable, IBM® PC 25 Pin | AS017-02 |
| RS232 Interface Cable, (connects impact printer) | AS017-06 |
| RS232 Interface Cable, IBM® PC 9 Pin | AS017-09 |
| RS232 Interface Cable, Apple® IIGS/Macintosh | AS017-10 |
| Printer | AS142 |

5.8 Specifications

Analyticals

| | | | | | |
|--|--|-----|-----|-----|-----------|
| Capacity (g) | 62 | 110 | 162 | 210 | 100/210 * |
| Readability (mg) | 0.1 | | | | 0.1/1 |
| Weighing units | g, mg, <u>oz</u> , <u>oz t</u> , ct, <u>dwt</u> , <u>taels (3)</u> , <u>mommies</u> , <u>gn</u> , <u>ti</u> , <u>N</u> , custom unit | | | | |
| Application modes | Parts counting, animal weighing, percent | | | | |
| Features | GLP, time, date, lockswitch | | | | |
| Repeatability (Std. dev.) (mg) | 0.1 | | | | 0.1/0.5 |
| Linearity (mg) (±) | 0.2 | | | | 0.2/0.5 |
| Tare range | Full capacity by subtraction | | | | |
| Safe overload capacity | 150 % of capacity | | | | |
| Stabilization time | ≤ 4 seconds | | | | |
| Sensitivity drift PPM/° C (10° C - 30° C) | 3 | | | | |
| Operating temperature range: w/internal calibration w/o internal calibration | 10° to 40° C/ 50° to 104° F 10° to 30° C/50° to 86° F | | | | |
| Calibration | InCAL™ calibration | | | | |
| Power requirements | External Adapter, 100 -120 V ac, 220 - 240 V ac, 50/60 Hz Plug configuration for US, Euro, UK, Japan & Australia | | | | |
| Draft shield (in/cm) (free height above platform) | 10.2/25.9 | | | | |
| Display (in/cm) | 0.6/1.5 | | | | |
| Pan size (in/cm) | 3.5/9. diameter | | | | |
| Dimensions (WxHxD) (in/cm) | 9 x 15.25 x14/22.8 x 38.7 x 35.5 | | | | |

Precision Top Loaders

| | | | | | | | | | | | | | |
|--|---|--------|--------------|----------|------------------------------------|------|------|----------|-----------|------------|-----------------------|--------|--------|
| Capacity (g) | 210 | 410 | 610 | 100/410* | 610 | 1550 | 2100 | 4100 | 6100 | 1000/4100* | 4100** | 6100** | 8100** |
| Readability (g) | 0.001 | | 0.001/0.01 | | 0.01 | | | 0.01/0.1 | | 0.1 | | | |
| Weighing units | g, mg, kg, lbs, <u>oz</u> , <u>oz t</u> , ct, <u>dwt</u> , <u>taels (3)</u> , <u>mommies</u> , <u>gn</u> , <u>ti</u> , <u>N</u> , custom unit | | | | | | | | | | | | |
| Application modes | Parts counting, animal weighing, percent | | | | | | | | | | | | |
| Features | GLP, time, date, lockswitch, LFT (U.S.)/type approved | | | | | | | | | | | | |
| Repeatability (Std. dev.) (g) | 0.0005 | 0.0015 | 0.0005/0.005 | | 0.005 | | | 0.01 | 0.01/0.05 | | 0.05 | | |
| Linearity (g) (±) | 0.002 | | 0.002/0.005 | | 0.02 | | | 0.04 | 0.02/0.05 | | 0.1 | | |
| Tare range | Full capacity by subtraction | | | | | | | | | | | | |
| Stabilization time | ≤ 3 second | | | | | | | | | | | | |
| Sensitivity drift PPM/° C (10° C - 30° C) | 4 | 3 | 4 | 3 | 5 | 4 | 3 | 4 | 3 | | | | |
| Operating temperature range: w/internal calibration w/o internal calibration | 10° to 40° C/50° to 104° F 10° to 30° C/50° to 86° F | | | | | | | | | | | | |
| Calibration | InCAL™ calibration | | | | | | | | | | | | |
| Power requirements | External Adapter, 100 -120 V ac, 220 - 240 V ac, 50/60 Hz Plug configuration for US, Euro, UK, Japan & Australia | | | | | | | | | | | | |
| Draft shield (in/cm) (free height above platform) | 10.2/25.9 | | | | | | | | | | | | |
| Display (in/cm) | 0.6/1.5 | | | | | | | | | | | | |
| Pan size (in/cm) | 4.7/12 Dia. | | | | 6.8 x 6.8/17.2 x 17.2 w/windshield | | | | | | 8 x 8/ 20.3 x 20.3 ** | | |
| Dimensions (WxHxD) (in/cm) | 9x15.25x14/22.8x38.7x35.5 | | | | 8.25 x 4 x 14/20.9 x 10.1 x 35.5 | | | | | | | | |

* Moveable FineRange™ ** Balances with internal calibration are equipped with a 6" x 6" Pan and Windshield.

NOTE: Not all weighing modes apply depending upon capacity and resolution of the balance.

NOTE: Availability of shaded weighing units subject to local regulations.

Admissible ambient conditions

Use only in closed rooms

Temperature range: 5 °C to 40 °C

Atmospheric humidity: 80% rh @ to 30 °C

Voltage fluctuations: -15% +10%

Installation category: II

Pollution degree: 2

Power supply voltage: 12 V ac, 50/60 Hz or 12 V dc, 1A

Power adapter: AP2805E 220 - 240V, 50/60 Hz, 100 mA

AP2805 110 - 120V, 50/60 Hz, 150 mA

LIMITED WARRANTY

Ohaus products are warranted against defects in materials and workmanship from the date of delivery through the duration of the warranty period. During the warranty period Ohaus will repair, or, at its option, replace any component(s) that proves to be defective at no charge, provided that the product is returned, freight prepaid, to Ohaus.

This warranty does not apply if the product has been damaged by accident or misuse, exposed to radioactive or corrosive materials, has foreign material penetrating to the inside of the product, or as a result of service or modification by other than Ohaus. In lieu of a properly returned warranty registration card, the warranty period shall begin on the date of shipment to the authorized dealer. No other express or implied warranty is given by Ohaus Corporation. Ohaus Corporation shall not be liable for any consequential damages.

As warranty legislation differs from state to state and country to country, please contact Ohaus or your local Ohaus dealer for further details.



Ohaus Corporation
19A Chapin Road,
P.O. Box 2033
Pine Brook, NJ 07058-2033, USA
Tel: (973) 377-9000,
Fax: (973) 593-0359

OHAUS UK Ltd
64 Boston Road
Beaumont Leys
Leicester LE4 1AW
England

With offices worldwide.