

Operating Manual

Translation of the original operating manual

VDL (E3.1)

Vacuum Drying Oven

with microprocessor program controller MB2

| Model | Model version | Art. No. |
|------------|---------------|-----------|
| VDL 23 | VDL023-230V | 9630-0009 |
| VDL 23-UL | VDL023UL-120V | 9630-0013 |
| VDL 56 | VDL053-230V | 9630-0010 |
| VDL 56-UL | VDL053UL-120V | 9630-0014 |
| VDL 115 | VDL115-230V | 9630-0011 |
| VDL 115-UL | VDL115UL-120V | 9630-0015 |

BINDER GmbH

- ▶ Address: Post office box 102, 78502 Tuttlingen, Germany ▶ Phone: +49 7462 2005 0
- ▶ Fax: +49 7462 2005 100 ▶ Internet: <http://www.binder-world.com>
- ▶ E-mail: info@binder-world.com ▶ Service Hotline: +49 7462 2005 555
- ▶ Service Fax: +49 7462 2005 93 555 ▶ Service E-Mail: customerservice@binder-world.com
- ▶ Service Hotline USA: +1 866 885 9794 or +1 631 224 4340 x3
- ▶ Service Hotline Asia Pacific: +852 390 705 04 or +852 390 705 03
- ▶ Service Hotline Russia and CIS: +7 495 988 15 16

Contents

| | |
|---|-----------|
| 1. SAFETY | 8 |
| 1.1 Personnel Qualification | 8 |
| 1.2 Operating manual..... | 8 |
| 1.3 Legal considerations | 9 |
| 1.4 Structure of the safety instructions..... | 10 |
| 1.4.1 Signal word panel | 10 |
| 1.4.2 Safety alert symbol | 10 |
| 1.4.3 Explosion protection symbol | 10 |
| 1.4.4 Pictograms in this manual..... | 11 |
| 1.4.5 Word message panel structure | 12 |
| 1.5 Localization / position of safety labels on the chamber | 12 |
| 1.6 Type plate..... | 13 |
| 1.7 Safety instructions on installing and operating the vacuum drying oven | 14 |
| 1.7.1 Safety instructions on installation and ambient conditions of the chamber | 14 |
| 1.7.1.1 Aeration / ventilation of the installation site | 15 |
| 1.7.1.2 No installation in potentially explosive areas of Zone 1 or 0 | 15 |
| 1.7.1.3 Equipotential bonding according to the grounding concept..... | 15 |
| 1.7.1.4 Accessibility to the disconnection from the power grid | 16 |
| 1.7.1.5 Technical ventilation (extraction) | 16 |
| 1.7.2 Safety instructions on compressed air supply | 16 |
| 1.7.3 Safety instructions on vacuum supply | 17 |
| 1.7.3.1 Selection and location of a suitable pump..... | 17 |
| 1.7.3.2 Observing the permissible gas inlet temperature | 18 |
| 1.7.3.3 Technical Ventilation (extraction) | 18 |
| 1.7.4 Safety instructions on the charging material..... | 19 |
| 1.7.5 Safety instructions on operating the vacuum drying oven..... | 20 |
| 1.8 Ex classification of the chamber and immediate surroundings..... | 23 |
| 1.9 Intended use | 25 |
| 1.10 Foreseeable Misuse | 28 |
| 1.11 Residual Risks | 30 |
| 2. OPERATOR RESPONSIBILITY, DOCUMENTATION, AND MEASURES | 32 |
| 2.1 Risk assessment / explosion protection document..... | 32 |
| 2.2 Employee training and protocols..... | 32 |
| 2.3 Operating instructions | 33 |
| 2.4 Safety data sheets | 33 |
| 2.5 Protective equipment | 33 |
| 2.6 Standard Operating Procedures (SOPs) | 34 |
| 2.7 Testing and maintenance..... | 35 |
| 2.8 Operation log..... | 35 |
| 3. DESCRIPTION OF THE EQUIPMENT | 36 |
| 3.1 Manufacturer's safety plan: Protective measures and equipment | 37 |
| 3.2 Chamber overview | 41 |
| 3.3 Triangular instrument box with MB2 controller..... | 42 |
| 3.4 Connections on the rear of the chamber..... | 42 |
| 3.5 Area classification, information for the zone classification..... | 44 |
| 3.5.1 Area classification inside the chamber | 45 |
| 3.5.2 Area classification in the surroundings of the chamber | 46 |
| 3.5.3 Area classification in the surroundings of the chamber: extraction lead to the pump, location of the pump | 47 |
| 4. COMPLETENESS OF DELIVERY, TRANSPORTATION, STORAGE, AND INSTALLATION | 48 |
| 4.1 Unpacking, and checking equipment and completeness of delivery | 48 |
| 4.2 Guidelines for safe lifting and transportation..... | 49 |
| 4.3 Storage..... | 49 |

| | | |
|-----------|---|-----------|
| 5. | LOCATION OF INSTALLATION AND AMBIENT CONDITIONS..... | 49 |
| 5.1 | General requirements for installation | 49 |
| 5.2 | Ventilation and extraction (technical ventilation)..... | 51 |
| 5.2.1 | Ventilation for heat removal in normal operation | 51 |
| 5.2.2 | Technical ventilation during chamber operation and when emptying the condensate catchpot of the pump | 51 |
| 5.2.3 | Air supply (breaking the vacuum) during operation with inert gas..... | 51 |
| 5.3 | Equipotential bonding..... | 52 |
| 5.4 | Ambient conditions | 52 |
| 5.5 | Compressed air supply for sweeping the area for electrical equipment, the preheating chamber, and the controller housing..... | 52 |
| 5.6 | Fire extinguisher..... | 52 |
| 5.7 | Lightning protection device | 52 |
| 6. | INSTALLATION AND CONNECTIONS | 53 |
| 6.1 | Vacuum expansion racks and rack holders | 53 |
| 6.2 | Mounting the pressure regulator | 54 |
| 6.3 | Connecting compressed air supply for sweeping the area for electrical equipment, the preheating chamber, and the controller housing..... | 56 |
| 6.4 | Pump module (option)..... | 56 |
| 6.4.1 | Mounting | 57 |
| 6.4.2 | Achieving equipotential bonding acc. to the grounding plan | 58 |
| 6.4.3 | Connection of an extraction system at the pump module..... | 59 |
| 6.5 | Vacuum connection..... | 59 |
| 6.5.1 | Instructions for using vacuum pumps | 59 |
| 6.5.2 | Vacuum pump VP4 (option)..... | 61 |
| 6.5.3 | Installation of the vacuum pump VP4 in the pump module (option) | 62 |
| 6.5.4 | Note on the use of a flame arrester | 64 |
| 6.5.5 | ATEX connection kit for vacuum pump VP4 (option) | 64 |
| 6.6 | Connecting inert gas supply..... | 64 |
| 6.7 | Mounting the tilt protection holders | 65 |
| 6.8 | Achieving equipotential bonding / Grounding concept..... | 66 |
| 6.9 | Electrical connection | 68 |
| 7. | EXPLOSION SAFETY TESTS BEFORE COMMISSIONING..... | 70 |
| 7.1 | Scope of the functional test..... | 70 |
| 7.2 | Explosion protection plan | 70 |
| 7.3 | Objective of testing..... | 71 |
| 7.4 | Testing before initial commissioning | 71 |
| 7.4.1 | Scope of the test..... | 71 |
| 7.4.1.1 | Testing the plausibility of the explosion protection plan and measures | 71 |
| 7.4.1.2 | Verifying the implementation of measures | 72 |
| 7.4.1.3 | Checking the deadlines for the recurring tests | 72 |
| 7.4.1.4 | Verifying the maintenance plan | 72 |
| 7.4.2 | Tests of technical ventilation systems, gas warning devices, inerting devices, devices, protective systems or safety, control or regulating devices, and other technical devices for explosion protection | 73 |
| 7.5 | Inspection after changes requiring review | 73 |
| 7.6 | Recurring tests for the explosive safety of the system | 73 |
| 8. | FUNCTIONAL OVERVIEW AND MENU STRUCTURE OF THE CONTROLLER | 74 |
| 8.1 | Operating functions in normal display..... | 75 |
| 8.2 | Display views: Normal display, program display, chart-recorder display..... | 76 |
| 8.3 | MB2 controller icons overview | 77 |
| 8.4 | MB2 controller operating modes | 79 |
| 8.4.1 | MB2 controller menu structure..... | 79 |
| 8.4.2 | Main menu | 80 |
| 8.4.3 | “Settings” submenu..... | 81 |
| 8.4.4 | “Service” submenu..... | 81 |
| 8.5 | Principle of controller entries..... | 82 |
| 8.6 | Performance during and after power failures..... | 82 |

| | | |
|------------|--|------------|
| 9. | START UP AND PERFORMING THE DRYING PROCESS | 83 |
| 9.1 | Requirements for safe commissioning | 83 |
| 9.2 | Overview of the drying process | 84 |
| 9.3 | Sweeping the area for electrical equipment, the preheating chamber, and the controller housing (triangular instrument box) with compressed air | 86 |
| 9.3.1 | Setting the pressure regulator for sweeping with compressed air | 86 |
| 9.3.2 | Sweeping before starting up / restarting the chamber | 87 |
| 9.3.3 | Sweeping during chamber operation | 87 |
| 9.3.4 | Sweeping after completion of chamber operation (recommended): | 88 |
| 9.4 | Condition after establishing the power connection | 88 |
| 9.5 | Standby mode Turning on and off the vacuum drying oven | 89 |
| 9.6 | Controller settings upon start up | 90 |
| 9.7 | Loading | 91 |
| 9.8 | Evacuation | 93 |
| 9.9 | Breaking the vacuum (flooding) | 93 |
| 9.9.1 | Ventilation after completing the drying procedure (flooding with ambient air or inert gas) | 93 |
| 9.9.2 | Operation with inert gas | 93 |
| 9.9.3 | Ventilation / breaking the vacuum in case of a power failure | 94 |
| 9.9.4 | Ventilation before completing the drying procedure (flooding with ambient air or inert gas) | 94 |
| 9.10 | Unloading the loading material | 95 |
| 9.11 | Removing the full condensate catchpot of the pump | 96 |
| 9.12 | Preparing a new drying process | 96 |
| 10. | SET-POINT ENTRY | 97 |
| 10.1 | Set-point entry through the "Setpoints" menu | 97 |
| 10.2 | Direct setpoint entry via Normal display | 98 |
| 11. | SETTING SPECIAL CONTROLLER FUNCTIONS | 99 |
| 11.1 | Menu structure | 99 |
| 11.1.1 | "Functions on/off" menu | 99 |
| 11.1.2 | "Control on/off" menu | 100 |
| 11.2 | Using the optional universal connection "GAS/AIR 2" for ventilation | 100 |
| 11.3 | Close all valves | 101 |
| 11.4 | Activating / deactivating temperature control | 101 |
| 11.5 | Activating / deactivating pressure control | 102 |
| 11.6 | Drying monitoring | 103 |
| 12. | AUTHORIZATION LEVELS AND PASSWORD PROTECTION | 105 |
| 12.1 | User management, authorization levels and password protection | 105 |
| 12.2 | Log in | 107 |
| 12.3 | Log out | 108 |
| 12.4 | User change | 109 |
| 12.5 | Password assignment and password change | 109 |
| 12.5.1 | Password change | 109 |
| 12.5.2 | Deleting the password for an individual authorization level | 111 |
| 12.5.3 | New password assignment for "service" or "admin" authorization level when the password function was deactivated | 112 |
| 12.6 | Activation code | 113 |
| 13. | GENERAL CONTROLLER SETTINGS AND INFORMATION | 114 |
| 13.1 | Selecting the controller's menu language | 114 |
| 13.2 | Setting date and time | 114 |
| 13.3 | Selecting the temperature unit | 116 |
| 13.4 | Display configuration | 116 |
| 13.4.1 | Adapting the display parameters | 116 |
| 13.4.2 | Touchscreen calibration | 117 |
| 13.5 | Event list | 118 |
| 13.6 | Service contact page | 118 |
| 13.7 | Current operating parameters | 119 |
| 13.8 | Technical chamber information | 119 |

| | |
|---|------------|
| 14. TEMPERATURE SAFETY DEVICES | 120 |
| 14.1 Safety temperature limiter (TL) class 2..... | 120 |
| 14.2 Overtemperature safety controller class 2..... | 120 |
| 14.2.1 Safety controller mode..... | 120 |
| 14.2.2 Setting the safety controller..... | 121 |
| 14.2.3 Message and measures in the state of alarm..... | 122 |
| 14.2.4 Function check..... | 122 |
| 15. TOLERANCE RANGE SETTINGS | 122 |
| 15.1 Setting the alarm delay times and the tolerance ranges..... | 122 |
| 15.1.1 Alarm condition..... | 123 |
| 16. NOTIFICATION AND ALARM FUNCTIONS | 123 |
| 16.1 Information messages..... | 123 |
| 16.2 Alarm messages..... | 125 |
| 16.3 Resetting an alarm..... | 126 |
| 16.4 Activating / deactivating the audible alarm (buzzer)..... | 126 |
| 16.5 Test alarm of the safety temperature limiter (TL)..... | 127 |
| 17. TIMER PROGRAM (STOPWATCH FUNCTION) | 129 |
| 17.1 Starting a timer program..... | 129 |
| 17.1.1 Performance during program delay time..... | 130 |
| 17.2 Stopping a running timer program..... | 130 |
| 17.2.1 Pausing a running timer program..... | 130 |
| 17.2.2 Cancelling a running timer program..... | 130 |
| 17.3 Performance after the end of the program..... | 130 |
| 18. TIME PROGRAMS | 131 |
| 18.1 Starting an existing time program..... | 131 |
| 18.1.1 Performance during program delay time..... | 132 |
| 18.2 Stopping a running time program..... | 132 |
| 18.2.1 Pausing a running time program..... | 132 |
| 18.2.2 Cancelling a running time program..... | 132 |
| 18.3 Performance after the end of the program..... | 132 |
| 18.4 Creating a new time program..... | 133 |
| 18.5 Program editor: program management..... | 133 |
| 18.5.1 Deleting a time program..... | 134 |
| 18.6 Section editor: section management..... | 135 |
| 18.6.1 Add a new program section..... | 136 |
| 18.6.2 Copy and insert or replace a program section..... | 136 |
| 18.6.3 Deleting a program section..... | 137 |
| 18.7 Value entry for a program section..... | 138 |
| 18.7.1 Section duration..... | 138 |
| 18.7.2 Set-point ramp and set-point step..... | 139 |
| 18.7.3 Special controller functions..... | 140 |
| 18.7.4 Setpoint entry..... | 141 |
| 18.7.5 Tolerance range..... | 141 |
| 18.7.6 Repeating one or several sections within a time program..... | 142 |
| 18.7.7 Saving the time program..... | 143 |
| 19. WEEK PROGRAMS | 143 |
| 19.1 Starting an existing week program..... | 144 |
| 19.2 Cancelling a running week program..... | 144 |
| 19.3 Creating a new week program..... | 145 |
| 19.4 Program editor: program management..... | 146 |
| 19.4.1 Deleting a week program..... | 147 |
| 19.5 Section editor: section management..... | 147 |
| 19.5.1 Add a new program section..... | 148 |
| 19.5.2 Copy and insert or replace a program section..... | 149 |
| 19.5.3 Deleting a program section..... | 149 |

| | | |
|------------|--|------------|
| 19.6 | Value entry for a program section in the Section view..... | 149 |
| 19.6.1 | Set-point ramp and set-point step modes..... | 150 |
| 19.6.2 | Weekday..... | 150 |
| 19.6.3 | Start time..... | 150 |
| 19.6.4 | Setpoint entry..... | 151 |
| 19.6.5 | Special controller functions..... | 151 |
| 20. | NETWORK AND COMMUNICATION | 152 |
| 20.1 | Ethernet..... | 152 |
| 20.1.1 | Configuration..... | 152 |
| 20.1.2 | Display of MAC address | 153 |
| 20.2 | Web server..... | 153 |
| 20.3 | E-Mail..... | 154 |
| 21. | USB MENU: DATA TRANSFER VIA USB INTERFACE | 155 |
| 21.1 | Using the USB connection during chamber operation..... | 155 |
| 22. | CHART RECORDER DISPLAY | 156 |
| 22.1 | Views..... | 156 |
| 22.1.1 | Show and hide legend | 156 |
| 22.1.2 | History display..... | 156 |
| 22.2 | Setting the parameters..... | 158 |
| 23. | REFERENCE MEASUREMENTS | 159 |
| 23.1 | Checking the temperature in the inner chamber..... | 159 |
| 23.1.1 | Checking the controller display..... | 159 |
| 23.1.2 | Checking the spatial temperature exactitude | 159 |
| 23.1.3 | Checking the function of the manometer for compressed air sweeping..... | 160 |
| 24. | OPTIONS..... | 161 |
| 24.1 | APT-COM™ 4 Multi Management software (option) | 161 |
| 24.2 | Analog outputs for temperature and pressure (option) | 161 |
| 24.3 | Object temperature display with flexible Pt 100 temperature sensor (option) | 162 |
| 24.3.1 | Connection of the object temperature sensor..... | 162 |
| 24.3.2 | Display on the MB2 controller..... | 163 |
| 25. | CLEANING AND DECONTAMINATION | 164 |
| 25.1 | Safety instructions on cleaning and decontamination..... | 164 |
| 25.2 | Cleaning..... | 165 |
| 25.3 | Decontamination / chemical disinfection..... | 166 |
| 26. | MAINTENANCE AND SERVICE, TROUBLESHOOTING, REPAIR, TESTING. 167 | |
| 26.1 | General information, personnel qualifications..... | 167 |
| 26.2 | Simple troubleshooting..... | 168 |
| 26.3 | Maintenance, Service..... | 171 |
| 26.3.1 | Safety instructions on maintenance work | 171 |
| 26.3.2 | Maintenance intervals | 172 |
| 26.4 | Service Reminder..... | 172 |
| 26.4.1 | BINDER Service contact data..... | 172 |
| 26.5 | Sending the chamber back to BINDER GmbH | 173 |
| 27. | DISPOSAL..... | 173 |
| 27.1 | Disposal of the transport packing..... | 173 |
| 27.2 | Decommissioning..... | 173 |
| 27.3 | Disposal of the chamber in the Federal Republic of Germany | 174 |
| 27.4 | Disposal of the chamber in the member states of the EU except for the Federal Republic of Germany..... | 175 |
| 27.5 | Disposal of the chamber in non-member states of the EU | 176 |
| 28. | TECHNICAL DESCRIPTION..... | 176 |
| 28.1 | Factory calibration and adjustment..... | 176 |
| 28.2 | Over current protection | 177 |

| | | |
|------------|---|------------|
| 28.3 | VDL / VDL-UL technical data | 177 |
| 28.4 | Equipment and options (extract) | 179 |
| 28.5 | Accessories and spare parts (extract) | 180 |
| 28.6 | Dimensions..... | 182 |
| 28.6.1 | VDL 23 | 182 |
| 28.6.2 | VDL 56 | 183 |
| 28.6.3 | VDL 115 | 184 |
| 29. | INDEX..... | 185 |
| 30. | CERTIFICATES AND DECLARATIONS OF CONFORMITY..... | 187 |
| 30.1 | EU Declaration of Conformity..... | 187 |
| 30.2 | Certificate for the GS mark of conformity of the “Deutsche Gesetzliche Unfallversicherung e.V.” (German Social Accident Insurance) DGUV | 190 |
| 31. | CONTAMINATION CLEARANCE CERTIFICATE | 192 |
| 31.1 | For chambers located outside USA and Canada | 192 |
| 31.2 | For chambers located in USA and Canada | 195 |

List of figures

| | | |
|------------|---|-----|
| Figure 1: | Position of labels on the chamber (example)..... | 12 |
| Figure 2: | Type plate (example of VDL 115) | 13 |
| Figure 3: | VDL 115 with MB2 controller | 41 |
| Figure 4: | Triangular instrument box (controller housing) with MB2 program controller and USB interface..... | 42 |
| Figure 5: | Chamber rear (example: VDL 115)..... | 42 |
| Figure 6: | Rear connection panel VDL with options | 43 |
| Figure 7: | Area classification of the closed chamber (view without housing, insulation, heater and outer chamber)..... | 45 |
| Figure 8: | Area classification in the surroundings of the chamber (schematic representation, standard device)..... | 46 |
| Figure 9: | Area classification in the surroundings of the chamber during operation (example)..... | 47 |
| Figure 10: | Operating the expansion racks | 53 |
| Figure 11: | Mounting the pressure regulator on the chamber rear | 54 |
| Figure 12: | Compressed air connection on the pressure regulator..... | 56 |
| Figure 13: | VDL mounted on pump module | 57 |
| Figure 14: | Pump module, rear view (example size 115)..... | 57 |
| Figure 15: | Position of the Vacuum connection (6) on the chamber rear (example size 56)..... | 59 |
| Figure 16: | Vacuum pump VP 4 (MZ2C EX) | 61 |
| Figure 17: | Variable length of the tilt protection holder depending on the bend | 65 |
| Figure 18: | Possibilities of grounding (schematic representation) | 66 |
| Figure 19: | Mounting the grounding cable on the VDL rear panel | 67 |
| Figure 20: | Grounding cable for the equipotential bonding between the condensate collecting tray and the pump module via..... | 68 |
| Figure 21: | Normal display of the MB2 program controller (sample values)..... | 74 |
| Figure 22: | Operating functions of the MB2 controller in normal display (example values)..... | 75 |
| Figure 23: | Pressure regulator and sweeping plug for compressed air sweeping on the chamber rear | 86 |
| Figure 24: | analog pressure display (manometer) for compressed air sweeping on the chamber front..... | 86 |
| Figure 25: | Pressure regulator with defined setting at the upper stop | 87 |
| Figure 26: | Schematic timing of the drying process and drying monitoring | 103 |
| Figure 27: | Pressure regulator and sweeping plug for compressed air sweeping on the chamber rear ... | 160 |
| Figure 28: | Connection cable on the “Analog output” (3b) connection..... | 161 |
| Figure 29: | SUB-D socket for the analog outputs option..... | 161 |
| Figure 30: | Measuring connection (12) with measuring access port..... | 162 |
| Figure 31: | Connection cable on the “Object temperature input” connection (3a) | 163 |
| Figure 32: | Plug connection between measuring access port and Lemo socket..... | 163 |
| Figure 33: | Cable connection of the optional Pt 100 sensor | 163 |

Dear customer,

For the correct operation of the VDL vacuum drying oven, it is important that you read this operating manual completely and carefully and observe all instructions as indicated. Failure to read, understand and follow the instructions may result in personal injury. It can also lead to damage to the chamber and/or poor equipment performance.

1. Safety

1.1 Personnel Qualification



The chamber must only be installed, tested, and started up by personnel qualified for assembly, startup, and operation of the chamber with additional skills in explosion protection (ATEX). Qualified personnel are persons whose professional education, knowledge, experience and knowledge of relevant standards allow them to assess, carry out, and identify any potential hazards in the work assigned to them. They must have been trained and instructed, and be authorized, to work on the chamber. This includes a basic knowledge of explosion protection (ATEX training), instruction based on the risk assessment by the operator (chap. 2.2) and knowledge of the Operating Instruction by the operator.

The device shall only be operated by laboratory personnel especially trained for this purpose and familiar with all precautionary measures required for working acc. to ATEX Directive 2014/37/EU. Observe the national regulations on minimum age of laboratory personnel.

1.2 Operating manual

This operating manual is part of the components of delivery. Always keep it handy for reference in the vicinity of the chamber. If selling the unit, hand over the operating manual to the purchaser.

To avoid injuries and property damage observe the safety instructions of the operating manual. Failure to follow instructions and safety precautions can lead to significant risks and to the loss of explosion protection.

| | |
|--|---|
|   | <div style="background-color: red; color: white; text-align: center; padding: 5px;">  DANGER </div> <p>Explosion hazard due to failure to observe the instructions and safety precautions. Serious injuries and chamber damage. Risk of death.</p> <ul style="list-style-type: none"> ➤ Observe the safety instructions in this Operating Manual. ➤ Follow the operating procedures in this Operating Manual. ➤ Carefully read the complete operating instructions of the chamber prior to installing and using the chamber. ➤ Keep the operating manual for future reference. |
|--|---|

| | |
|---|--|
|  | <p>Make sure that all persons who use the chamber and its associated work equipment have read and understood the Operating Manual.</p> |
|---|--|

This Operating Manual is supplemented and updated as needed. Always use the most recent version of the Operating Manual. When in doubt, call the BINDER Service Hotline for information on the up-to-date-ness and validity of this Operating Manual.

1.3 Legal considerations

This operating manual is for informational purposes only. It contains information for correct and safe installing, start-up, operation, decommissioning, cleaning and maintenance of the product. The content of this operating manual takes into account the applicable regulatory requirements and the latest technology. Note: the contents and the product described are subject to change without notice.

Understanding and observing the instructions in this operating manual are prerequisites for hazard-free use and safety during operation and maintenance. Images are to provide basic understanding. They may deviate from the actual version of the chamber. The actual scope of delivery can, due to optional or special design, or due to recent technical changes, deviate from the information and illustrations in these instructions this operating manual. In no event shall BINDER be held liable for any damages, direct or incidental arising out of or related to the use of this manual.

This operating manual cannot cover all conceivable applications. If you would like additional information, or if special problems arise that are not sufficiently addressed in this manual, please ask your dealer or contact us directly, e.g. by phone at the number located on page one of this manual.

Furthermore, we emphasize that the contents of this operating manual are not part of an earlier or existing agreement, description, or legal relationship, nor do they modify such a relationship. All obligations on the part of BINDER derive from the respective purchase contract, which also contains the entire and exclusively valid statement of warranty administration and the general terms and conditions, as well as the legal regulations valid at the time the contract is concluded. The statements in this manual neither augment nor restrict the contractual warranty provisions.

Furthermore, relevant national and international regulations on occupational safety apply. The operator must know, comply with, and implement these requirements. In particular, this includes the provisions of ATEX Operational Directive 1999/92/EC ("ATEX 137") (implemented for Germany in the Industrial Safety Regulation (BetrSichV) and the Ordinance on Hazardous Substances (GefStoffV)). The operator is responsible for choosing suitable work equipment for the areas classified as explosion hazards and for installing and operating equipment in accordance with respective requirements.

Limitation of liability

BINDER GmbH is not liable for any damage arising from the following causes:

- Non-observance of Instruction Manual
- Improper use
- Improper installation, setup, maintenance, repair
- Inspections not being performed (testing before initial commissioning, recurring tests, testing before recommissioning)
- Negligence or willful intent
- Incorrect response to malfunctions
- Assignment of improperly or insufficiently trained personnel
- Technical changes and modifications made by the operator and not approved by the manufacturer
- Use of non-approved accessories and replacement parts

We reserve the right to technical changes as part of improvements to operating characteristics and further development.

Have repairs performed only by experts authorized by BINDER. Repaired chambers must comply with the quality standard specified by BINDER. In particular, carry out an inspection before recommissioning after maintenance or repairs. These can only be performed by the manufacturer or specially trained personnel (in Germany: Qualified Persons per BetrSichVO).

1.4 Structure of the safety instructions

In this operating manual, the following safety definitions and symbols indicate dangerous situations following the harmonization of ISO 3864-2 and ANSI Z535.6.

1.4.1 Signal word panel

Depending on the probability of serious consequences, potential dangers are identified with a signal word, the corresponding safety color, and if appropriate, the safety alert symbol.

| |
|--|
|  DANGER |
| Indicates an imminently hazardous situation that, if not avoided, will result in death or serious (irreversible) injury. |

| |
|--|
|  WARNING |
| Indicates a potentially hazardous situation which, if not avoided, could result in death or serious (irreversible) injury. |

| |
|---|
|  CAUTION |
| Indicates a potentially hazardous situation which, if not avoided, may result in moderate or minor (reversible) injury. |

| |
|---|
| NOTICE |
| Indicates a potentially hazardous situation, which, if not avoided, may result in damage to the product and/or its functions or to property in its proximity. |



























1.4.2 Safety alert symbol

| | |
|---|--|
|  | Use of the safety alert symbol indicates a risk of injury Observe all measures that are marked with the safety alert symbol in order to avoid death or injury. |
|---|--|

1.4.3 Explosion protection symbol

| | |
|---|--|
|  | Use of the explosion protection symbol warns against explosion hazards . Observe all measures in this operating manual to avoid the formation of explosive atmosphere as well as explosions. |
|---|--|

1.4.4 Pictograms in this manual

| Warning signs | | | |
|---|---|--|---|
|  Danger of injury |  Electrical hazard |  Hot surface |  Explosive atmosphere |
|  Stability hazard |  Lifting hazard |  Inhalation hazard |  Suffocation hazard |
|  Harmful substances |  Biohazard |  Risk of corrosion and / or chemical burns |  Pollution Hazard |
| Mandatory action signs | | | |
|  Mandatory regulation |  Read operating instructions |  Disconnect the power plug |  Lift with several persons |
|  Environment protection |  Wear protective gloves |  Wear eye protectors |  Ground before use |
|  Release before mainte- nance or repairs |  Wear ESD shoes (antistatic shoes) |  Wipe with damp cloth only | |
| Prohibition signs | | | |
|  Do NOT touch |  Do NOT spray with water |  Do not place anything on the chamber | |
|  | Information to be observed in order to ensure optimum function of the product. | | |

1.4.5 Word message panel structure

Type and cause of hazard.

Possible consequences.

- ⊘ Instruction how to avoid the hazard: prohibition
- Instruction how to avoid the hazard: mandatory action

Observe all other notes and information not necessarily emphasized in the same way, in order to avoid disruptions that could result in direct or indirect injury or property damage.

1.5 Localization / position of safety labels on the chamber

The following labels are located on the chamber door:





| Safety labels | |
|--|--------------------------------------|
|  | Hot surface |
|  | Do not place anything on the chamber |
|  | Wipe surfaces with damp cloth only |
|  | |
| Service label | |
|  | |



Figure 1: Position of labels on the chamber (example)



Keep safety labels complete and legible.

Replace safety labels that are no longer legible. Contact BINDER Service for these replacements.

1.6 Type plate

Position of type plate: left chamber side (seen from front), at the bottom right-hand.











| | | | | | | |
|---|--|----------------------------------|---|--|---|---|
| Nominal temp. | 110 °C 230 °F | 1,60 kW / 7,0 A 230 V / 50 Hz |  |  |  | EXPLOSION PROOF INNER CHAMBER EX CLASSIF. ACC. TO 2014/34/EU EX II 2/3/- G IIB T3 GB/GC/- X MAX. TEMP. OF INNER CHAMBER SURFACE IN CAT 2: +160 °C MAX. TEMP. OF HEATING CHAMBER SURFACE IN CAT 3: +195 °C TEMP. CLASS T3 |
| IP protection | 20 | 230 V / 60 Hz 1 N ~ |  |  |  | |
| Safety device Class | DIN 12880 2.0 | | | | | |
| Art. No. | 9630-0011 | | | | | |
| Project No. Built | | | | | | |
| | 2021 | VACUUM DRYING OVEN | | | |  |
|  | BINDER GmbH Im Mittleren Ösch 5 78532 Tuttlingen / Germany www.binder-world.com | | | VDL 115 E3.1 | Serial No. 00000000000000 Made in Germany | |

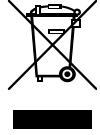

Figure 2: Type plate (example of VDL 115)

Indications of the type plate (example)

| Indication | Information |
|--|--|
| BINDER | Manufacturer: BINDER GmbH |
| VDL 115 | Model designation |
| Vacuum Drying Oven | Chamber name: Vacuum drying oven |
| Serial No. | 000000000000 |
| Built | 2021 |
| Nominal temperature | 110 °C 230 °F |
| IP protection | 20 |
| Temp. safety device | DIN 12880 |
| Class | 2.0 |
| Art. No. | 9630-0011 |
| Project No. | --- |
| 1,60 kW | Nominal power |
| 7,0 A | Nominal current |
| 230 V / 50 Hz 230 V / 60 Hz | Nominal voltage +/- 10% at the indicated power frequency |
| 1 N ~ | Current type |
| Explosion proof inner chamber | Explosion proof inner chamber |
| Ex classification acc. to 2014/34/EU Ex II 2/3/- G IIB T3 Gb/Gc/- X | Ex classification according to ATEX Directive 2014/34/EU |
| Max. temp. of inner chamber surface in cat. 2: +160 °C | Maximum temperature of the inner chamber surfaces: 160 °C / 320 °F (Device category 2) |
| Max. temp. of heating chamber surface in cat. 3: +195 °C | Maximum temperature of the outer surface of the preheating chamber (outer chamber): 185 °C / 365 °F (Device category 3) |
| Temp. class T3 | Temperature class acc. to IEC 60079-0 for the entire chamber |

Symbols on the type plate

| Symbol | Valid for | Information |
|---|--------------|--|
|  | All chambers | CE conformity marking |
|  | All chambers | Explosion protection symbol. Ex classification acc. to ATEX Directive 2014/34/EU |

| Symbol | Valid for | Information |
|---|---------------------|--|
|  | All chambers | Electrical and electronic equipment manufactured / placed on the market in the EU after 13 August 2005 and to be disposed of in a separate collection according to Directive 2012/19/EU on waste electrical and electronic equipment (WEEE). |
|  | Not for UL chambers | GS mark of conformity of the “Deutsche Gesetzliche Unfallversicherung e.V. (DGUV), Prüf- und Zertifizierungsstelle Nahrungsmittel und Verpackung im DGUV Test” (German Social Accident Insurance (DGUV), Testing and Certification Body for Foodstuffs and Packaging Industry in DGUV Test). |
|  | Not for UL chambers | The chamber is certified according to Customs Union Technical Regulation (CU TR) for the Eurasian Economic Union (Russia, Belarus, Armenia, Kazakhstan Kyrgyzstan). |

1.7 Safety instructions on installing and operating the vacuum drying oven

With regard to operating the vacuum drying oven VDL and to the installation location, please observe the relevant national regulations (for Germany in particular: DGUV guidelines 213-850 on safe working in laboratories, issued by the employers' liability insurance association; Industrial Safety Regulation (BetrSichV); Ordinance on Hazardous Substances (GefStoffV); Technical Regulations on Industrial Safety and Health (TRBS 1201 Part 1).

The central element of the Industrial Safety Regulation is the **risk assessment** performed by competent personnel which enables an employer to evaluate risks that may arise before using work equipment and to derive necessary and suitable tests and measures.

Explosion protection plan

The **explosion protection plan** to be created by the operator represents the entirety of the technical and organizational measures for explosion protection determined and specified on the basis of the risk assessment. In accordance with ATEX Operational Directive 1999/92/EC, these measures serve

- to prevent the formation of or to limit explosive atmospheres or to limit hazardous explosive mixtures
- to avoid the combustion of explosive atmospheres
- to limit the spread of an explosion and to minimize its effects on personnel in order to ensure the health and safety of employees

The explosion protection document serves to document the results of the risk assessment in accordance with § 6 Para. 9 GefStoffV (for Germany).

BINDER GmbH is only responsible for the safety features of the chamber provided skilled electricians or qualified personnel authorized by BINDER perform all maintenance and repair, and if components relating to chamber safety are replaced in the event of failure with original spare parts.

To operate the chamber, use only original BINDER accessories or accessories from third-party suppliers authorized by BINDER. The user is responsible for any risk caused by using unauthorized accessories.

1.7.1 Safety instructions on installation and ambient conditions of the chamber

Familiarize yourself with the local conditions, particularly allocation to a defined potentially explosive area (zones) and the according technical safety requirements. During installation, commissioning and operation of the vacuum drying oven and the connected vacuum pump or in-house vacuum supply, always follow the requirements defined by the classification of the installation site.

1.7.1.1 Aeration / ventilation of the installation site



| | |
|---|--|
|  | NOTICE |
| | <p>Danger of overheating due to lack of aeration. Damage to the chamber.</p> <ul style="list-style-type: none"> ⊘ Do NOT install the chamber in unventilated recesses. ➤ Ensure sufficient ventilation for dispersal of heat. ➤ Observe the prescribed minimum distances when installing the chamber (chap. 5.1) |

The vacuum drying ovens were constructed in accordance with the applicable VDE regulations and were routinely tested in accordance with VDE 0411-1 (IEC 61010-1). The production underlies an internal monitoring according to ATEX Directive 2014/34/EU appendix VIII.

For the user there is no risk of temporary overvoltages in the sense of EN 61010-1:2010.



1.7.1.2 No installation in potentially explosive areas of Zone 1 or 0

Even when the equipment is used properly, there exists a residual risk of explosion that cannot be excluded, particularly in relation to the environment of the chamber. To minimize this risk, strictly observe the legal regulations about how to select an appropriate location. Do not install and operate the vacuum drying oven VDL in occasionally or continuously / for long periods / frequently potentially explosive areas.

| | |
|--|--|
|  |  DANGER |
| | <p>Explosion hazard due to combustible dusts or explosive mixtures in the vicinity of the equipment. Serious injury or death from burns and / or explosion pressure.</p> <ul style="list-style-type: none"> ⊘ Do NOT operate the chamber in occasionally or continuously / for long periods / frequently potentially explosive areas. It is not intended for installation in a zone 1 or 0. ➤ KEEP combustible dusts AWAY from the equipment ➤ Make sure that air-solvent mixtures are NOT occasionally or continuously / for long periods / frequently in the vicinity of the equipment. ➤ Reliably prevent spreading of an explosive atmosphere to unprotected areas (see chap. 3.5). ➤ Strictly observe the relevant legal regulations about how to select an appropriate location. |

1.7.1.3 Equipotential bonding according to the grounding concept

The walkable installation and operating surface of the chamber must be conductive. This installation and operating surface must be connected to the vacuum drying oven according to the grounding concept (chap. 6.8). Cyclic measurements of the equipotential bonding are required.

| | |
|--|--|
|   |  DANGER |
| | <p>Explosion hazard by electric sparking due to missing or improperly implemented equipotential bonding. Serious injury or death from burns and / or explosion pressure.</p> <ul style="list-style-type: none"> ➤ Connect all equipment elements in the installation and operating area (VDL / pump module / pump) with the conductive surface and/or with each other. Proceed according to the grounding concept (Chap. 6.8). ➤ Measure the equipotential bonding prior to commissioning the equipment. ➤ Provide cyclic measurements of the equipotential bonding. |

1.7.1.4 Accessibility to the disconnection from the power grid



To completely separate the chamber from the power supply, you must disconnect the power plug. Install the chamber in a way that the power plug is easily accessible and can be easily pulled in case of danger.

The chamber's power plug is unprotected. The electrical connection must therefore be established outside a zone.

1.7.1.5 Technical ventilation (extraction)

The operator shall provide active extraction (technical ventilation according to country-specific regulations (TRBS 2152 Part 2 for Germany) before commissioning the chamber. Extraction must include the entire installation area of the vacuum drying oven and a vacuum pump. Observe the area classification in the surroundings of the chamber (chap. 3.5.3). Extraction must be active during the entire chamber operation. Operation, loading and unloading of the loading material and removal of the filled condensate catchpot of the pump must always take place under technical ventilation. If the technical ventilation fails, automatically switch off power to the chamber.

This will prevent spreading of an explosive atmosphere to unprotected areas (see chap. 3.5).



| | |
|---|---|
|  |  DANGER |
| | <p>Explosion hazard due to the spread of an explosive atmosphere to unprotected areas and ignition due to electric sparking or hot surfaces.</p> <p>Serious injury or death from burns and / or explosion pressure.</p> <ul style="list-style-type: none"> ➤ Provide active suction (technical ventilation according to country-specific regulations (TRBS 2152 Part 2 for Germany) prior to commissioning the chamber. ➤ Extraction must include the entire installation area of the vacuum drying oven. ➤ Make sure that the chamber is automatically turned off if the technical ventilation fails. |

1.7.2 Safety instructions on compressed air supply

Before starting / restarting the chamber, the electrical installation room, preheating chamber, and controller housing (triangular instrument box) must be swept with compressed air with maximum overpressure for a defined time (chap. 9.3).

Sweeping the area for electrical equipment, the preheating chamber and controller housing must take place with an overpressure of at least 25 Pa (recommendation: >40 Pa) during the entire operation of the vacuum drying oven. Also after termination or cancellation of the drying process, continued sweeping for at least 10 minutes is recommended.

An inlet pressure of 2 bar must be provided for compressed air sweeping. The compressed air supply line provided by the operator must be equipped with a monitoring device which clearly indicates a drop and increase in the inlet pressure outside the permissible tolerance of ± 0.2 bar.

| | |
|---|---|
|  |  DANGER |
| | <p>Explosion hazard by solvent-containing air penetrating the electrical area of the oven or the preheating chamber.</p> <p>Serious injury or death from burns and / or explosion pressure.</p> <ul style="list-style-type: none"> ➤ Make sure that sweeping the area for electrical equipment, preheating chamber, and controller housing with compressed air for the defined time (chap. 9.3.2) at maximum overpressure has been done before turning on the chamber. ➤ Make sure that sweeping the area for electrical equipment, preheating chamber, and controller housing with compressed air with an overpressure of at least 25 Pa (recommendation: >40 Pa) takes place during the entire operation. ➤ Ensure that the operator compressed air supply line is equipped with active monitoring of the defined inlet pressure. |

1.7.3 Safety instructions on vacuum supply



Prior to commissioning the chamber make sure that all relevant national and international regulations are observed. Within the European Union, units that will be operated in potentially explosive areas have to meet the requirements of ATEX Directive 2014/34/EU.



If combustible solvent is introduced into the drying chamber, the vacuum pump must be constructed in a suitable explosion-proof manner.

| | |
|--|---|
|  | Observe the safety instructions of the pump manufacturer. |
|--|---|

1.7.3.1 Selection and location of a suitable pump

The mixtures extracted from the inner chamber must be carried away making sure that there is no danger by ignition of these atmospheres. Sparking in the pump motor or the switching elements, electrostatic discharges, as well as hot pump parts can ignite solvent vapors in the event of an error. To minimize this risk, use an ATEX Directive 2014/34/EU compliant vacuum pump suitable for suction from Zone 0 or 1 and, if appropriate, from the zone of its installation site.



| | |
|--|--|
|   |  DANGER |
| | <p>Explosion hazard due to the spread of an explosive atmosphere to unprotected pump parts and ignition due to electric sparking on the pump motor or switching elements, electrostatic discharges, or hot surfaces.</p> <p>Serious injury or death from burns and / or explosion pressure.</p> <ul style="list-style-type: none"> ➤ Use only suitable, explosion-proof pumps. See chap. 6.5.1. ➤ Operate the pump in a stationary position and secure it so it is immobile. ➤ Make sure that the suction line to the vacuum connection (6) of the VDL is securely attached and conductive. ➤ Ensure sufficient solvent condensation, e.g., in an exhaust waste vapor condenser, to avoid that ignitable solvent concentrations are conducted from the pump. Otherwise, the exhaust pipe after the pump must be securely attached and conductive; and suction must be done in an explosion-proof area. ➤ Ensure equipotential bonding between the pump, the VDL vacuum drying oven and, if appropriate, the pump module using the connections of the grounding conductors according to the grounding concept (Chap. 6.8). <p>[continued...]</p> |

| | |
|--|---|
|   | <p>[...continuation]</p> <ul style="list-style-type: none"> ➤ Confirm that the vacuum pump is designed for a gas inlet temperature corresponding to the used drying temperature, or take appropriate measures to cool down the extracted vapor before it enters the vacuum pump. ➤ Use ATEX compliant vacuum pumps providing an integral protective device for the pump OR Install a current-dependent, delayed protective device for the pump (for the triggering time of this protective device, see the manufacturer's specifications). The protective and monitoring device must not be able to turn on independently again or be released. ➤ Use ATEX compliant vacuum pumps providing an integral explosion proof switch OR make sure that the switch gear box is either installed outside the hazardous area or that it is explosion proof. |
|--|---|

| | |
|---|---|
|  | <p>The ATEX compliant vacuum pump offered by BINDER provides an integral protective device for the pump and an integral explosion proof switch.</p> |
|---|---|

1.7.3.2 Observing the permissible gas inlet temperature

Confirm that the vacuum pump / vacuum system is designed for a gas inlet temperature corresponding to the used drying temperature, or take appropriate measures to cool down the extracted vapor before it enters the vacuum pump / vacuum system. If the gas inlet temperature is too high and then becomes even warmer by compression in the pump, the resulting temperature (of the gas-solvent mixture inside the pump) could exceed the solvent's temperature class and auto-ignition temperature. **The ATEX compliant vacuum pumps offered by BINDER are designed for a gas inlet temperature of 40 °C / 104 °F max.** Do NOT exceed this temperature.



| | |
|---|--|
|  |  DANGER |
| | <p>Fire and explosion hazard by exceeding the auto-ignition temperature of the solvent due to excessive gas inlet temperature Damage to the vacuum pump. Serious injury or death from burns and / or explosion pressure.</p> <ul style="list-style-type: none"> ⊘ Do NOT exceed the maximum gas inlet temperature of the pump (ATEX compliant vacuum pumps from BINDER: 40 °C). ➤ When operating with a higher set-point temperature take appropriate measures to cool down the extracted vapor before it enters into to the vacuum pump. |

1.7.3.3 Technical Ventilation (extraction)

When manipulating the vacuum pump (removing the filled condensate catchpot of the pump) or in the event of an error (e.g. dropping or spilling the filled condensate catchpot) spreading of an explosive atmosphere to unprotected parts of the pump or the vacuum drying oven would be possible.

The operator must provide active extraction (technical ventilation according to country-specific regulations – TRBS 2152 Part 2 for Germany) prior to commissioning and manipulating the vacuum pump. Extraction must include the entire installation area of the vacuum drying oven, the pump and, if appropriate, the pump module. Handling the pump always takes place under technical ventilation.

This will prevent spreading of an explosive atmosphere to unprotected chamber parts other than the defined area (see Chap. 3.5).



| | |
|---|--|
|  |  DANGER |
| | <p>Explosion hazard due to the spread of an explosive atmosphere to unprotected parts of the pump or the vacuum drying oven and ignition due to electric sparking or hot surfaces.</p> <p>Serious injury or death from burns and / or explosion pressure.</p> <ul style="list-style-type: none"> ➤ Provide active suction (technical ventilation according to country-specific regulations (TRBS 2152 Part 2 for Germany) prior to commissioning the vacuum pump. ➤ Extraction must include the entire installation area of the vacuum drying oven, the pump and, if appropriate, the pump module. ➤ When using the pump module, connect an extraction system to the provided exhaust port as described in the mounting instructions of the pump module (Art. no. 7001-0401). |

1.7.4 Safety instructions on the charging material



The temperature class of the inner chamber according to IEC 60079-0 can be T1, T2, or T3. Only introduce substances with an auto-ignition temperature that is higher than 200 °C / 392 °F. You can use a solvent which would form an explosive mixture with air under normal conditions.

If the auto-ignition temperature of a solvent contained in the drying material is exceeded during the drying process, there is an immediate risk of fire and explosion. This chamber is not suitable to dry substances with an auto-ignition temperature below 200 °C / 392 °F. Substances falling under explosion group / gas group IIC are not permitted (e.g. carbon disulfide, hydrogen).

Combustible dusts are generally not permitted, neither in the vicinity nor as a load.

| | |
|---|---|
|  |  DANGER |
| | <p>Explosion hazard due to unsuitable drying material.</p> <p>Serious injury or death from burns and / or explosion pressure.</p> <ul style="list-style-type: none"> ∅ Do NOT introduce any substance with an auto-ignition temperature below 200 °C / 392 °F into the chamber ∅ Do NOT introduce combustible dusts into the chamber. ∅ Do NOT introduce any substance which tends towards exothermal decomposition into the chamber. ∅ Do NOT introduce any substance which comes under the explosive substance law into the chamber. ∅ Do NOT introduce energy sources such as batteries or lithium-ion batteries into the chamber. ∅ Do NOT introduce any substance which could lead to release of toxic gases into the chamber. |

Familiarize yourself with the physical and chemical properties of the charging material, as well as the contained moisture constituent and its behavior with the addition of heat energy and changes in pressure. No dangerous chemical reactions must occur during the drying process.

| | |
|---|--|
|  |  DANGER |
| | <p>Fire and explosion hazard caused by chemical reactions with the addition of heat energy and changes in pressure.</p> <p>Serious injury or death from burns and / or explosion pressure.</p> <ul style="list-style-type: none"> ➤ Make sure that no dangerous chemical reactions of the loading material can occur during the drying process. |



Familiarize yourself with any potential health risks caused by the charging material, the contained moisture constituent or by reaction products that may arise during the drying process. Take adequate measures to exclude such risks prior to putting the VDL vacuum drying oven into operation.

1.7.5 Safety instructions on operating the vacuum drying oven



Note the following points before starting up the oven:

- When loading the chamber and possibly at the moment of unloading, also in the context of intended use, an explosive mixture may form in the working space. Define a safety area of at least 1m from the chamber front and ensure active extraction (technical ventilation).
- The walkable installation and operating surface of the chamber must be conductive. This installation and operating surface must be connected to the vacuum drying oven according to the grounding concept. Cyclic measurements of the equipotential bonding are required.
- The operator must ensure an appropriate ventilation of the loading area in front of the oven front prior to commissioning of the chamber.
- Ensure that at no time any solvent vapors could enter in the area of the electrical installation room, preheating chamber, and controller housing (triangular instrument box).
- Provide technical ventilation in the area of the vacuum pump stand, particularly in the areas of the condensate catchpot (when emptying it) and the exhaust air of the vacuum pump.
- The personal protective equipment (PPE) of the operating personnel must be ESD protected.
- Only trained personnel with password authorization may work on the VDL vacuum drying oven.



DANGER

**Electrical hazard by water entering the chamber.
Deadly electric shock.**

- ∅ The equipment must NOT become wet during operation, cleaning, or maintenance.
- ∅ Do NOT install the equipment in damp areas or in puddles.
- Set up the equipment in a splash-proof manner.



DANGER

**Electrical hazard due to damage to the equipment
Deadly electric shock.**

- ∅ Do NOT insert any objects, particularly metallic objects, in louvers or other openings or slots on the chamber
- ∅ Do NOT operate the chamber if the housing is damaged.
- ∅ Do NOT operate the chamber if the power cord is damaged.
- Disconnect the chamber from the power supply in case of an obvious malfunction.



CAUTION

**Danger of burning when touching the hot inner surfaces during operation.
Burns.**

- ∅ Do NOT touch the inner surfaces or the charging material during and after operation.

When operating the VDL vacuum drying oven with inert gas correctly follow the technical ventilation measures according to the local and national regulations relevant for your country (for Germany: DGUV guidelines 213-850 on safe working in laboratories, issued by the employers' liability insurance association).



Do not start up the chamber without active technical ventilation .

During operation with inert gas the chamber is supplied with an oxygen displacing gas (e.g. N₂). Inert gases in high concentrations are hazardous to health. They are colorless and almost odorless and therefore practically imperceptible. Inhalation of inert gases can cause drowsiness up to respiratory arrest. When the O₂ content of the air decreases below 18%, there is risk of death from lack of oxygen. Any gas that might escape has to be led out via good room ventilation or a suitable exhaust system.



DANGER

**Suffocation hazard due to high concentration of inert gas.
Death by suffocation.**

- ⊘ Do NOT set up chambers in non-ventilated recesses.
- Make sure that technical ventilation measures are active.
- Respect the relevant regulations for handling inert gases.
- When decommissioning the vacuum drying oven, shut off the inert gas supply.

If solvent-containing air penetrates the electrical area of the oven or the preheating chamber, explosions may result.



DANGER

Explosion hazard by solvent-containing air penetrating the electrical area of the oven or the preheating chamber.

Serious injury or death from burns and / or explosion pressure.

- ⊘ Do NOT take the air, which will be used to supply the chamber with compressed air, from a potentially explosive atmosphere.
- Ensure that the operator compressed air supply line is equipped with active monitoring of the defined inlet pressure.



The unit must not be operated without compressed air flushing at maximum overpressure and running compressed air flushing with active monitoring of the defined inlet pressure.



Avoid the solvent accumulation in the optional pump module as this would cause the vacuum module to become an occasionally or continuously / for long periods / frequently potentially explosive area (Zone 0 or 1). The VDL vacuum drying oven located on top of the module is implemented in Device category 3 in regards to its surroundings.



DANGER

Explosion hazard due to operating the oven with material containing solvent that may be able to form an explosive mixture with air.

Serious injury or death from burns and / or explosion pressure.

- Follow the measures listed below for operation with solvent-containing materials that can form an explosive mixture with air.

If the following precautions are not followed, the vapors resulting from heating of the solvent can ignite on the hot walls of the inner chamber.



Required measures for operation with solvent-containing materials that can form an explosive mixture with air:

- Sweep the area for electrical equipment, preheating chamber and controller housing for a defined time (chap. 9.3.2) prior to start-up with compressed air with maximum overpressure. Subsequent sweeping of the area for electrical equipment, preheating chamber and controller housing with an overpressure of at least 25 Pa (recommendation: >40 Pa) must take place during the entire operating cycle and must be monitored at the manometer on the chamber front. In addition, monitoring of the defined inlet pressure (2 bar) of the compressed air sweeping is required.
- Only after completing the defined sweeping time, put the chamber in operation.
- Take the auto-ignition temperature from the safety specifications of the solvent. In the case of solvent mixtures, use the auto-ignition temperature of the material with the lowest auto-ignition temperature. Make sure that the auto-ignition temperature is above 200 °C.
- Enter the temperature set-point (drying temperature) on the controller.
- Set the safety controller (temperature limiter class 2). Recommended setting: safety controller mode "Limit", safety controller value approx. 5 °C above the set-point.
- During the drying process, use only those solvents for which the auto-ignition temperature has been entered.
- Make sure that the technical ventilation is active. Make sure that the compressed air sweeping is active and that the defined inlet pressure is monitored. Bring in the material to be dried.
- Start the drying process. The heating unit is only released when a pressure threshold of 100 mbar is reached.
- Make sure that sweeping the area for electrical equipment, preheating chamber and controller housing with at least 25 Pa overpressure (see manometer display) takes place during the entire operating cycle. Recommended value: >40 Pa.
- The duration of the drying process can be determined by means of the pressure display on the controller. When the pressure drops to the set-point, the drying process is finished.
- Make sure that the technical ventilation is active. Make sure that the compressed air sweeping is active and that the defined inlet pressure is monitored. After termination of the drying process, ventilate the vacuum drying oven with ambient air or inert gas. Unload the loading material and turn off the oven.
- Sweep the area for electrical equipment, the preheating chamber, and the controller housing (triangular instrument box) at least 10 minutes with compressed air (recommended).
- Make sure that the technical ventilation is active when emptying the condensate catchpot of the vacuum pump.
- Make sure that sweeping the area for electrical equipment, preheating chamber and controller housing with at least 25 Pa overpressure (see manometer display) is active when emptying the condensate catchpot of the vacuum pump. Recommended value: >40 Pa.
- Before starting a new drying process with a different solvent, check again the auto-ignition temperature at the safety specifications of the solvent. In the case of solvent mixtures, use the auto-ignition temperature of the material with the lowest auto-ignition temperature. Make sure that the auto-ignition temperature is above 200 °C.

1.8 Ex classification of the chamber and immediate surroundings

The VDL vacuum drying oven is an assembly in the sense of ATEX Directive 2014/34/EU with the following Ex classification:

 II 2/3/- G IIB T3 Gb/Gc/- X

Explanation:

| | |
|-----|---|
| II | Use of the device above ground |
| 2 | Device category 2 per ATEX Directive 2014/34/EU Suitability for areas in which explosive atmospheres may occur occasionally. Inner chamber (drying chamber), tubing / line to the vacuum pump, areas inside the vacuum pump. See images of the areas in Chap. 3.5. |
| 3 | Device category 3 per ATEX Directive 2014/34/EU Suitability for areas in which explosive atmospheres may occur, on a rare and temporary basis: The entire device, with the exception of the device power plug, the plug connection of the optional analog output, and the plug connection for Ethernet is designed in Device category 3 in relation to the environment Pt 100 controller sensor, Pt 100 heating sensor Surrounding of the chamber, including loading area and outer side of the preheating chamber (outer chamber), area of installation of the vacuum pump, pump module. See images of the areas in Chap. 3.5. |
| - | No category per ATEX Directive 2014/34/EU Device power plug (unprotected device area). Plug connection for Ethernet. With optional analog outputs: Plug connection of the analog outputs The device power plug, the plug connection of the optional analog output, and the plug connection for Ethernet are unprotected. The electrical connection and the plug connections must therefore be established outside a zone. See images of the areas in Chap. 3.5. |
| G | Device category G per ATEX Directive 2014/34/EU Gas: Do not introduce combustible dust into the chamber or allow combustible dusts to be present in the vicinity of the chamber. |
| IIB | Equipment group IIB Substances falling under Gas group / Explosion group IIA or IIB are permitted. Substances falling under Gas group / Explosion group IIC are not permitted. |
| T3 | Temperature class of the inner chamber: T3 acc. to IEC 60079-0 Materials of temperature classes T4, T5, and T6 are not permitted. Introduce into the chamber only materials whose auto-ignition temperature exceeds 200 °C / 392 °F |
| Gb | Equipment protection level (EPL) Gb acc. to EN IEC 60079-0 / EN ISO 80079-36 Suitability for areas in which explosive atmospheres may occur occasionally. Inner chamber (drying chamber), tubing / line to the vacuum pump. |
| Gc | Equipment protection level (EPL) Gc acc. to EN IEC 60079-0 / EN ISO 80079-36 Suitability for areas in which explosive atmospheres may occur on a rare and temporary basis (fault): Chamber areas flushed with compressed air: Electrical installation area, electrical connection of the heater, preheating chamber between the inner and outer chamber with heater tubes (without electrical connections) and safety temperature limiter (TL |

| | |
|---|---|
| - | No equipment protection level (EPL) Gc acc. to EN IEC 60079-0 / EN ISO 80079-36 Device power plug, plug connection for Ethernet, plug connection of the optional analog outputs (unprotected device area) |
| X | Specific operating conditions: <ul style="list-style-type: none"> • Technical ventilation required • Equipotential bonding • Sweeping the area for electrical equipment, preheating chamber, and controller housing before start-up and during operation • Ambient temperature during operation: +18 °C up to +32 °C. • Use only humid cloths to wipe the chamber. |

The “VDL vacuum drying oven” assembly includes the following components and devices in the sense of the ATEX directive 2014/34/EU:

- **Inner chamber** (interior for drying material): Container, not a device in the sense of the ATEX directive 2014/34/EU

It is a purely mechanical component with no risk of ignition. No classification.

- **Outer chamber** (limitation of the preheating chamber to the outside): Container, not a device in the sense of the ATEX directive 2014/34/EU

It is a purely mechanical component with no risk of ignition. No classification.

- **Control** (controller)

The controller is located in the overpressure-swept controller housing (instrument triangle). No classification.

- **Safety temperature limiter** (TL): thermal switch (bimetal switch) for temperature monitoring, which leads to the heating being switched off, and a self-holding circuit, which is reset by disconnecting and reconnecting the power plug. No classification

The thermal switch is located in the overpressure-swept preheating chamber. The self-holding circuit is located in the overpressure-swept electrical installation area.

- **Pt 100 controller sensor and heating sensor**

Both sensors are located on the heating piping (zone 2 possible)

| | |
|---------|---|
| Ex [ic] | Ignition protection Intrinsic safety “I” per EN IEC 60079-11 Mechanical component Equipment protection level: Increased protection “ic”, suitable for placement in Zone 2  II 3 G Ex ic IIB T3 Gc |
|---------|---|

- Optional **Object temperature sensor** (simple equipment) with barrier (isolation amplifier)

| | |
|---------|--|
| Ex [ib] | Ignition protection Intrinsic safety “I” per EN IEC 60079-11 Equipment protection level: high protection “ib”, suitable for placement in Zone 1 (chamber interior) or 2  II 2 G Ex ib IIB T3 Gb |
|---------|--|

- **Pressure sensor with barrier** (isolation amplifier)

| | |
|---------|--|
| Ex [ib] | Ignition protection Intrinsic safety “I” per EN IEC 60079-11 Equipment protection level: high protection “ib”, suitable for placement in Zone 1 (chamber interior) or 2  II 2 G Ex ib IIB T3 Gb |
|---------|--|

- **Pressure limit switch and relay, 100 mbar**
It is located in the overpressure-swept electrical installation area. No classification
- **Power plug:** Connection outside of a zone required
No classification, unprotected.
- **Plug connection of the optional analog output:** Connection outside of a zone required
No classification, unprotected.
- **Plug connection for Ethernet:** Connection outside of a zone required
No classification, unprotected.
- **Electrical installation area, controller housing and heater area (preheating chamber) between the inner and outer chamber:** enclosure (overpressure, sweeping with compressed air)

| | |
|--------|--|
| Ex pzc | <p>Ignition protection Pressurized enclosure "p" per EN IEC 60079-2</p> <p>Equipment protection level: Increased protection "pzc", suitable for use in Zone 2 (chamber housing as protection against an explosive atmosphere in the event of a fault)</p> <p> II 3 G Ex pzc IIB T3 Gc</p> |
|--------|--|

1.9 Intended use



Following the instructions in this operating manual and conducting regular maintenance work (chap. 25) are part of the intended use.

Any use of the chambers that does not comply with the requirements specified in this Operating Manual shall be considered improper use.

Other applications than those described in this chapter are not approved.

Use

VDL vacuum drying ovens are suitable for drying and heat treatment of solid or nonflammable pulverized charging material, as well as bulk material, using the supply of heat under vacuum.

During this process, the contained solvent may be able to form an explosive mixture with air under normal conditions. Ignition of an explosive atmosphere is prevented in the VDL vacuum drying ovens by various safety measures. The maximum drying temperature lies by a standard safety factor below the maximum permitted auto-ignition temperature. The drying temperature must lie below the sublimation point of the loading material.

The VDL vacuum drying ovens are approved for drying of materials with organic solvents. This may cause unlimited amounts of solvents to appear temporarily. The chambers are equipped with an explosion-proof inner chamber.

The VDL vacuum drying ovens are not intended for installation in a Zone 1 or 0. The chamber must not be installed or operated in an occasionally or continuously / for long periods / frequently potentially explosive area. Measures must be taken to prevent the spread of explosive atmospheres to unprotected areas.

The chamber plug (power plug) is unprotected because it must be disconnected in case of an emergency to completely separate the chamber from the power supply. Therefore, the electrical connection must be established outside a zone.

Temperature class

The temperature class of the inner chamber according to IEC 60079-0 is T3. It depends on the maximum operation temperature inside the oven. The auto-ignition temperature is determined from the safety specifications of the solvent used. In the case of solvent mixtures, the solvent with the lowest auto-ignition temperature as this is critical.

According to IEC 60079-0 the VDL vacuum drying ovens are NOT suitable for the temperature classes T4, T5 and T6. Insert only substances with an auto-ignition temperature that is higher than 200 °C / 392 °F.

The information listed on the on the type plate.for explosion protection is essential for classification.



For the Device category, refer to the area classification information on the site of installation in Chap. 3.5.

Requirements for the chamber load

Insert only substances with an auto-ignition temperature that is higher than 200 °C / 392 °F into the VDL vacuum drying ovens. The chambers are not suitable to dry substances with an auto-ignition temperature below 200 °C / 392 °F. Substances falling under Gas group / Explosion group IIC are not permitted (e.g. carbon disulfide, acetylene, hydrogen. Substances falling under groups II A and II B may be introduced.

The VDL vacuum drying ovens are NOT suitable for the heat treatment of substances, which tend towards exothermal decomposition, or for materials that come under the legal definition of explosives. Such substances must not be introduced into the oven. Dangerous chemical reactions must not occur during the drying process. Exothermal reactions must definitely be excluded. Familiarize yourself with the physical and chemical properties of the loading material, as well as the contained moisture constituent and its behavior with the addition of heat energy and changes in pressure. Familiarize yourself with any potential health risks caused by the loading material, the contained moisture constituent or by reaction products that may arise during the temperature process. Take adequate measures to exclude such risks prior to putting the chamber into operation.

VDL vacuum drying ovens are NOT suitable for use in conjunction with explosive dust atmospheres or hybrid mixtures. Combustible dust are generally not permitted.

| | |
|---|--|
|  |  DANGER |
|  | <p>Explosion or implosion hazard and danger of poisoning by introduction of unsuitable loading material.</p> <p>Serious injury or death from burns and / or explosion pressure or by poisoning.</p> <ul style="list-style-type: none"> ⊘ Do NOT introduce any substance with an auto-ignition temperature below 200 °C / 392 °F into the chamber. ⊘ Do NOT introduce any combustible dust into the chamber. ⊘ Do NOT introduce any substance, which tend to exothermic decomposition into the chamber. ⊘ Do NOT introduce any substance, which fall under the explosives law into the chamber ⊘ Do NOT introduce energy sources such as batteries or lithium-ion batteries into the chamber. ⊘ Do NOT introduce any substance which could lead to release of toxic gases into the chamber. |

| | |
|---|---|
|  | <p>The loading material shall not contain any corrosive ingredients that may damage the machine components made of stainless steel and aluminum. Such ingredients include in particular acids and halides. Any corrosive damage caused by such ingredients is excluded from liability by BINDER GmbH.</p> |
|---|---|

Medical devices

The chambers are not classified as medical devices as defined by the Medical Device Directive 93/42/EEC and Regulation (EU) No 2017/745.

Equipotential bonding

Safe grounding can avoid electrostatic ignition hazards. The most important protective measure is to connect and ground all conductive parts. All conductive parts must have electrical potential. The grounding plan (Chap. 6.8) must be implemented.



Avoid electrostatic charges. Clean the device only with a damp cloth. Avoid rubbing with non-conductive materials.

Personnel Requirements

Only trained personnel with knowledge of explosion protection and knowledge of the Operating Manual can set up and install the chamber, start it up, operate, clean, and take it out of operation. Service and repairs call for further technical requirements (e.g. electrical know-how), as well as knowledge of the service manual. Follow the requirements for PPE (ESD protection).

Installation site requirements

The chambers are designed for setting up inside a building (indoor use).

Provide active extraction (technical ventilation according to country-specific regulations – TRBS 2152 Part 2 for Germany) on the installation site. It must cover the entire installation area of the VDL and the vacuum pump stand. Observe the area classification in the surroundings of the chamber (chap. 3.5.3). Suction must be active during the entire operation of the chamber and when handling the condensate catchpot of the pump. Suction must be conducted into an explosion-proof area.

Provide compressed air supply on the installation site. There must be at least 1.5 bar overpressure in the supply line. The operator's compressed air supply line must be equipped with active monitoring of the minimum supply pressure (1.5 bar), which shall clearly indicate any drop in pressure below the minimum pressure.

If the technical ventilation fails, automatically switch off power to the device.

VDL vacuum drying chambers are not intended for installation in a Zone 0 or 1. Measures must be taken to prevent the spread of explosive atmospheres to unprotected areas. It must be possible to turn off the device immediately in the event of a fault: Pull the power plug or operate e.g. a customer's explosion-protected emergency stop switch.

The requirements described in the Operating Manual for installation site and ambient conditions (Chap. 5) must be met.

In case of foreseeable use of the chamber there is no risk for the user through the integration of the chamber into systems or by special environmental or operating conditions in the sense of EN 61010-1:2010. For this, the intended use of the chamber and all its connections must be observed.

1.10 Foreseeable Misuse

Other applications than those described in chap. 1.8 are not approved.

This expressly includes the following misuses (the list is not exhaustive), which pose risks despite the inherently safe construction and existing technical safety equipment:

- Non-observance of the Operating Manual
- Non-observance of information and warnings on the chamber (e.g. controller messages, safety identifiers, warning signals)
- Installation, startup, operation, maintenance and repair by untrained, insufficiently qualified, or unauthorized personnel
- Missed or delayed maintenance and testing
- Non-observance of traces of wear and tear
- Operating the equipment without ESD protective equipment (e.g., clothing, gloves, shoes)
- Setting down the material to be loaded in the area around or on top of the chamber
- Occurrence of an impermissible zone outside specified areas (see Chap. 3.5)
- Improper termination of the drying process after incorrect loading with inadmissible solvent with too low an ignition temperature: Ventilating or opening the chamber without waiting for it to cool
- Passing on passwords for the admin level to users
- Emptying the condensate catchpot of the pump without having prior turned off the vacuum pump
- Insertion of materials, which are excluded or not permitted by this Operating Manual and/or are not permissible according to the Labeling on the type plate.
- Non-compliance with the admissible parameters for processing the respective material.
- Installation, testing, service or repair in the presence of solvents
- Material to be loaded remaining in the chamber after turning off.
- Loading non-approved solvents
- Incomplete ground connections for all system parts in the installation area
- Introduction of rust into the device
- Installation of replacement parts and use of accessories and operating resources not specified and authorized by the manufacturer
- Structural changes to the chamber without a subsequent risk assessment by the operator's ATEX representative
- Failure to observe the inspection and maintenance regulations (inspection before initial commissioning, recurring tests, inspection after maintenance or repairs, qualification of the tester)
- Commissioning after maintenance or repairs without passing the electrical safety test
- Commissioning after maintenance or repairs without passing the explosion protection test.
- Commissioning without correctly and completely grounding in accordance with the grounding plan
- Non-observance of traces of wear and tear, in particular rust
- Installation, startup, operation, maintenance or repair of the chamber in absence of a risk assessment and operating instructions from the operator
- Deliberate or careless handling of the chamber during operation (except the permitted operation of the controller).
- Bypassing or changing protective systems, operation of the chamber without the designated protective systems

- Establishing or disconnecting an electrical connection in the presence of an explosive atmosphere
- Non-observance of messages regarding cleaning and disinfection of the chamber.
- Wiping the chamber with a dry cloth, generating static charge
- Spilling water or cleaning agent on the chamber, water penetrating into the chamber during operation, cleaning or maintenance.
- Cleaning activity while the chamber is turned on.
- Operation of the chamber with a damaged housing or damaged power cord
- Continued operation of the chamber during an obvious malfunction
- Insertion of objects, particularly metallic objects, in louvers or other openings or slots on the chamber
- Human error (e.g. insufficient experience, qualification, stress, exhaustion, laziness)

To prevent these and other risks from incorrect operation, the operator shall issue operating instructions (chap. 2.3). The operator is also recommended to create Standard Operating Procedures (SOPs) (chap. 2.6, certain example avoidance measures are provided here).

| | | |
|--|---|--|
| Explosion hazard due to formation of explosive atmosphere in the presence of hot surfaces during air supply | Serious injury or death from burns and / or explosion pressure. | Observe the safety instructions in the operating manual and follow the instructions for correct air supply (breaking the vacuum). The “Manual ventilation” plug (7) must not be removed while the drying process is still running. If the drying process has not been completed, the interior of the chamber must have cooled down sufficiently before air supply and opening the door. |
| Normal operation with high concentration of inert gas | Danger of suffocation. Death by suffocation. | On the chamber side, gassing with inert gas is automatically interrupted when the ambient pressure is reached. Observe the warnings in the Operating Manual and follow the instructions for installation, technical ventilation measures, and decommissioning. Respect the relevant regulations for handling inert gas. |
| Explosion hazard due to mechanical spark formation in an explosive atmosphere by inserting or removing the slide-in modules in the presence of an explosive atmosphere | Serious injury or death from burns and / or explosion pressure. | Observe the warnings in the Operating Manual and follow the instructions for inserting or removing the expansion racks. |
| Explosion hazard due to mechanical formation in an explosive atmosphere due to rust | Serious injury or death from burns and / or explosion pressure. | Observe the warnings in the operating instructions and follow the instructions for checking the chamber and expansion racks for corrosion. Do not use corroded components. Never allow rust to permeate into the chamber. |

1.11 Residual Risks

The unavoidable design features of a chamber, as well as its proper field of application, can also pose risks for the user, even during correct operation. These residual risks include hazards which, despite the inherently safe design, existing technical protective equipment, safety precautions and supplementary protective measures, cannot be ruled out.

Messages on the chamber and in the Operating Manual warn of residual risks. The consequences of these residual risks and the measures required to prevent them are listed in the Operating Manual. Moreover, the operator must take measures to minimize hazards from unavoidable residual risks. This includes, in particular the Operator measures described in chap. 2. Residual hazards are to be taken into account by the operator in their risk assessment. This includes, in particular, issuing operating instructions.

The following list summarizes the hazards against which this Operating Manual and the Service Manual warn, and specifies protective measures at the appropriate spots (list is not exhaustive):

- Flames, explosion

Unpacking, Transport, Installation

- Sliding or tilting the chamber
- Setup of the chamber in unauthorized areas
- Connecting the power plug in unauthorized areas
- Plug connection of the optional analog outputs in unauthorized areas
- Plug connection to the Ethernet in unauthorized areas
- Installation of a damaged chamber
- Installation of a chamber with damaged power cord
- Inappropriate site of installation
- Missing protective conductor connection
- Use of unsuitable pump or vacuum systems
- Improperly connected pump
- Missing or improperly executed equipotential bonding
- Missing or improperly designed technical ventilation in the installation area
- Missing or improperly designed compressed air supply in the installation area, missing monitoring of the minimum supply pressure of the compressed air supply

Normal operation

- Assembly errors
- Lack of electrical testing before initial commissioning or recommissioning
- Insufficient or missing technical ventilation (extraction) at the installation area of VDL and pump
- Insufficient or missing or not monitored compressed air sweeping of the electrical installation room, preheating chamber, and controller housing (triangular instrument box) prior to start-up
- Insufficient or missing or not monitored compressed air sweeping of the electrical installation room, preheating chamber, and controller housing (triangular instrument box) during chamber operation
- Contact with hot surfaces on the housing
- Contact with hot surfaces in the interior and inside of doors
- Emission of non-ionizing radiation from electrical operating resources
- Use of inert gas in higher concentration (optional)
- Use of unsuitable pump and discharge

-
- Excessively high gas intake temperature or insufficient cooling of the extracted vapor before entering the vacuum pump
 - Contact with live parts in normal state
 - Operation without supervision

Cleaning and Decontamination

- Explosive atmosphere during cleaning and decontamination
- Electrostatic charges
- Penetration of water into the chamber
- Inappropriate cleaning and decontamination agents
- Enclosure of persons in the interior

Malfunction and Damage

- Continued operation of the chamber during an obvious malfunction or outage of the heater or vacuum system
- Contact with live parts during error status
- Operation of a unit with damaged power cord

Maintenance

- Maintenance work on live parts.
- Explosive atmosphere during maintenance
- Execution of maintenance work by untrained/insufficiently qualified personnel
- Electrical safety analysis during annual maintenance not performed
- Verification of explosion protection during annual maintenance not performed
- Incorrect and incomplete grounding before recommissioning

Trouble-shooting and Repairs

- Non-observance of warning messages in the Service Manual
- Trouble-shooting of live parts without specified safety measures
- Absence of a plausibility check to rule out erroneous inscription of electrical components
- Performance of repair work by untrained/insufficiently qualified personnel
- Inappropriate repairs which do not meet the quality standard specified by BINDER
- Use of replacement parts other than BINDER original replacement parts
- Electrical safety analysis not performed after repairs
- Verification of explosion protection not performed after repairs

2. Operator responsibility, documentation, and measures



This is NOT an exhaustive list of the required measures and documents! □
Follow applicable national and international regulations.

The chamber is intended for commercial use. The operator must know, comply with, and implement the relevant regulations on occupational safety. In particular, this includes the conditions of the Industrial Safety Regulation 1999/92/EC (Title: Improvement of the Health Protection and Safety of Workers Who May Be Endangered by Explosive Atmospheres). Known as ATEX 137, this directive was implemented in Germany through the Industrial Safety Regulation (BetrSichV) and the Ordinance on Hazardous Substances (GefStoffV).

2.1 Risk assessment / explosion protection document

First, a **risk assessment** is carried out to determine the hazards that are present where the chamber is used due to the working conditions. When documenting the risk assessment, the operator must provide specific evidence of the hazards posed by explosive mixtures in the **explosion protection document**.

When creating the explosion protection document, follow applicable national regulations (for Germany: Industrial Safety Regulation (BetrSichV); Ordinance on Hazardous Substances (GefStoffV)).

In particular, the explosion protection document must indicate

- Determination and evaluation of explosion hazards
- Explosion protection plan

The explosion protection plan to be created by the operator represents the entirety of the technical and organizational measures for explosion protection determined and specified on the basis of the risk assessment. These measures should prevent the formation of hazardous explosive mixtures or to limit or prevent their ignition. They should also minimize the spread of an explosion and its effects

The explosion protection document serves to document the results of the risk assessment in accordance with § 6 Para. 9 GefStoffV (for Germany).

- Classification as explosion protection zones
- Explosion protection measures
- Cooperation with various companies
- Test findings on explosion protection and technical protection measures

2.2 Employee training and protocols

The operator must ensure that all employees have read and understood the Operating Manual.

Before employees use the vacuum drying oven and related work equipment for the first time, the operator must provide them with sufficient and suitable information on the hazards presented and measures to be taken in a form and language that is understandable.

This includes the information resulting from the risk assessment:

- Hazards when using the vacuum drying oven and related work equipment, in particular fire and explosion hazards, functioning of protective devices
- Required protective measures and code of conduct
- Necessity of wearing personal protective equipment, which must be implemented ESD protected.

- Procedure for cleaning and repair work
- Measures for operational interruptions, accidents, and first aid for emergencies

The operator must clearly define the responsibilities for installation, operation, troubleshooting, maintenance, and cleaning. It must be ensured that untrained personnel have no access to the chamber and related work equipment and systems.

The operator must instruct employees with regard to their activity before they begin using the vacuum drying oven and related work equipment. Following this, further instruction must be provided at regular intervals, at least once per year. The date of each instruction and the names of the instructed persons must be recorded in writing.

It is essential for safe and secure operation of the device that the user be familiar with the safety plan from the manufacturer and the explosion protection plan from the operator.

Do not work on the chamber or in its surroundings, under any circumstances, after consuming alcohol, drugs, and certain medications which may impair the ability to perceive, assess, and react.

2.3 Operating instructions

The measures to avoid hazards resulting from the risk assessment (Chap. 2.1) are to be specified as **Operating instructions**. Before employees use the vacuum drying oven and related work equipment for the first time, the operator must specify instructions for safe use in one or more operating instructions. These must comply with regulatory requirements and be verified regularly to ensure that they are up to date.

When creating the operating instructions, follow applicable national regulations (for Germany: Industrial Safety Regulation (BetrSichV); Ordinance on Hazardous Substances (GefStoffV)).



Keep these operating instructions with the chamber at all times in a place where they are clearly visible. They must be comprehensible and written in the language of the employees.

2.4 Safety data sheets

A central component of the VDL safety plan is determining the correct **auto-ignition temperature** of the solvent used. The corresponding maximum drying temperature (safety temperature) is then determined according to the information panel "Temperature setting". In the case of solvent mixtures, using the solvent with the lowest auto-ignition temperature is essential. The data sheets for the solvents used must therefore be available at all times. They can be maintained in writing or electronically. If they are stored electronically, it must be ensured that all employees have access when needed. If an electronic medium is – temporarily – not available, another source must be found or work must be postponed for this time. (DGUV 4.1)

2.5 Protective equipment

The operator must provide the operating personnel with the necessary protective equipment.

The personal protective equipment (PPE) of the operating personnel must be implemented ESD protected.

When using gloves make sure that they are conductive. The same applies for shoes and other elements that can lead to electrostatic charges.

2.6 Standard Operating Procedures (SOPs)

The operator is responsible to determine the correct auto-ignition temperature of the solvent. To ensure this, creating **Standard Operating Procedures (SOPs)** is recommended.

In particular, this should prevent the **Residual Risks due to incorrect operation** specified in Chap. 1.11 and the exceeding of the auto-ignition temperature of the solvent.

When creating Standard Operating Procedures, take into account the information and instructions in this Operating Manual. The following are some **examples** of these risks and suggestions for measures to be taken. These are to be created, adapted, and supplemented by the operator using the risks determined and respective conditions at the installation site.

| Risk | Measures |
|--|---|
| Operation of the device by untrained users | <ul style="list-style-type: none"> • Ensure knowledge of the Operating Manual • Use only ATEX-trained personnel • Create operating instruction and standard operating procedures |
| Use of an unsuitable solvent with a too low ignition temperature Cause: Assumption of wrong solvent | <ul style="list-style-type: none"> • Prior to each new drying procedure check again the auto-ignition temperature with the safety specifications. • Clearly label the material to be dried to avoid confusion Information: There is no risk during the proper drying process, since this takes place in a vacuum. There is only a risk in the event of premature air supply (termination of the drying process). <ul style="list-style-type: none"> • Avoid premature air supply. Also observe the instructions in the Operating Manual. |
| Reloading with a material with a lower auto-ignition temperature | <ul style="list-style-type: none"> • Prior to each new drying procedure check again the auto-ignition temperature with the safety specifications and the desired drying temperature. If appropriate, let the chamber cool down before reloading |
| Termination of the drying process due to inadmissible solvent with a too low ignition temperature. Ventilation with ambient air or opening the still hot chamber Cause: 2 operating errors: incorrect loading with an inadmissible solvent; improper Termination of the drying process | <ul style="list-style-type: none"> • Disconnect the power plug and turn off the pump. • Let the chamber cool down to room temperature. • Do NOT remove the "Manual ventilation" plug. • Only ventilate when the interior temperature has cooled to room temperature. Only then open the door. |
| Unnoticed sensor drift or failure of safety devices due to missing or delayed maintenance and tests | <ul style="list-style-type: none"> • Perform regular maintenance and the prescribed tests of the chamber. • Create detailed maintenance and testing plans and ensure they are implemented. |

This list is NOT exhaustive. The risks result from the risk assessment to be done by the operator (Chap. 2.1). The measures must be determined by the operator of the device based on the risks determined and the respective conditions at the installation site.

2.7 Testing and maintenance

The operator must ensure that the chamber is always in a technically functional state.

Observe the maintenance intervals specified by the manufacturer. If there is above-average strain, the intervals must be shortened accordingly.

The operator must regularly verify that the safety-related devices are functioning correctly.

Document tests with results and measures that were potentially initiated, as well as maintenance and repairs, in a system book.

For testing before commissioning, see Chap. 7

For recurring tests and maintenance, see Chap. 7.5, 7.6, 25.

2.8 Operation log

For safety reasons, keeping an operation log which documents each individual drying process is recommended.

The following contents should be entered and recorded:

- Type of solvent
- Auto-ignition temperature of the solvent; in the case of solvent mixtures: solvent with the lowest Auto-ignition temperature
- Entered temperature set-point (drying temperature)
- Drying temperature set-point
- Set safety controller mode temperature (Limit/Offset)
- Set safety controller value
- Date
- Signature

Use the following specimen or compile it in a suitable form.

Operation log for the VDL vacuum drying oven

Serial number.....

| Solvent. In the case of solvent mixtures: solvent with the lowest Auto-ignition temperature | Auto-ignition temperature [unit] | Drying temperature / temperature set-point [unit] | Safety controller mode Limit/Offset | Safety controller value [unit] | Date | Signature |
|---|----------------------------------|---|-------------------------------------|--------------------------------|------|-----------|
| | | | | | | |
| | | | | | | |
| | | | | | | |
| | | | | | | |
| | | | | | | |
| | | | | | | |
| | | | | | | |

3. Description of the equipment

Vacuum drying is used for special drying problems, for which conventional drying methods cannot offer a solution due to physical limitations.

The VDL vacuum drying oven is approved for drying materials with organic solvents.

Ex classification

The chamber is equipped with an explosion proof inner chamber and additional measures for explosion protection.

The Ex classification of the vacuum drying oven VDL (assembly) acc. to ATEX Directive 2014/34/EU is

 II 2/3/- G IIB T3 Gb/Gc/- X

The description of explosion protection on the type plate determines the chamber's classification.

Detailed information on the Ex classification of the assembly and the individual devices can be found in chap. 1.8.

The maximum possible surface temperature of the chamber interior is 160 °C / 320 °F.

Installation

The VDL vacuum drying oven may be installed in areas in which explosive atmospheres may occur on a rare and temporary basis. The entire chamber with the exception of the power plug is classified in category 3 in relation to the environment. The chamber plug (power plug) is unprotected, therefore the electrical connection must be established outside a zone. With optional analog outputs: The plug connection of the analog output is unprotected and must therefore be established outside a zone. Also the plug connection for computer communication via Ethernet is unprotected and therefore must be established outside a zone.

Temperature class

The temperature class of the inner chamber acc. to EN 60079-0 is **T3**. The temperature class of the entire chamber equals the temperature class of the inner chamber.

Controller

The chambers are equipped with a multifunctional microprocessor display controller with 2-channel technology for temperature and pressure. Temperature is indicated accurate to one-tenth of a degree, the pressure inside the chamber accurate to one 1 mbar. Pressure is measured by a firmly installed pressure sensor.

The chamber is regularly equipped with the MB2 display program controller. This efficient program controller is equipped with a multitude of operating functions, in addition to recorder and alarm functions. Programming of test cycles is easily accomplished via the modern MB2 touch screen controller and is also possible directly with a computer via Intranet in connection with the APT-COM™ 4 Multi Management Software (option, chap. 24.1).

The chamber comes equipped with an Ethernet serial interface for computer communication and with a USB interface. The plug connection for Ethernet is unprotected and therefore must be established outside a zone. In addition, the BINDER APT-COM™ 4 Multi Management Software permits networking up to 100 chambers and connecting them to a PC for controlling and programming, as well as recording and representing temperature and pressure data. For further options, see chap. 24.

Material

The inner chamber is made of especially corrosion resistant stainless steel V4A (German material no. 1.4404, US equivalent AISI 316L) micro-polished. The rack holder and all of the chamber's vacuum connections and valves are made of especially corrosion resistant stainless steel V4A (German material no. 1.4571, US equivalent AISI 316Ti). The housing is RAL 7035 powder-coated. All corners and edges of the housing are also completely coated. When operating the chamber at temperatures above 150 °C / 302 °F, the impact of the oxygen in the air may cause discoloration of the metallic surfaces (yellowish-brown or blue) by natural oxidation processes. These colorations are harmless and will in no way impair the function or quality of the chamber.

The chambers are jacket-heated. The preheating chamber technique ensures a completely homogeneous jacket temperature, ensuring uniform heat transfer into the inner chamber. The low-loss heat transfer to the material uses the aluminum vacuum expansion racks (or optionally available in stainless steel). The elastic-mounted safety glass window reliably compensates any overpressure or explosions that may occur. The laminated safety glass pane ensures proven and effective splinter protection in the event of an implosion.

The chambers provide a universal connection for inert gas / ambient air, a compressed air connection for sweeping the electrical installation area, the preheating chamber, and the controller housing, and a measuring connection, e.g. serving to connect a measuring access port for the optional object temperature display.

All installable items, such as racks and rack holders, can be easily removed. The completely smooth inner chamber with its rounded corners and internally welded seams is easy to clean.

The minimum working temperature of the vacuum drying oven is approx. 10 °C / 18 °F above room temperature. The maximum temperature is 110 °C / 230 °F.

Vacuum pumps with a suction capacity of 1 m³/h to 30 m³/h are suitable for the VD vacuum drying oven.

3.1 Manufacturer's safety plan: Protective measures and equipment

The following measures were taken on the manufacturer's side in order to prevent ignition and explosions.

- **Ignition source monitored via safety temperature limiter (TL) class 1**

Only solvents with an auto-ignition temperature above 200 °C may be entered into the chamber.

There is a safety margin of 20% of the minimum permissible auto-ignition temperature of 200 °C, related to the hottest point in the interior (where the heating is attached to the inner chamber). The maximum surface temperature of the inner chamber is 160 °C. Therefore, when operated correctly, the hot surfaces are always below the auto-ignition temperature of permitted substances.

The safety temperature limiter (TL) serves to protect the vacuum drying oven, its environment and loading material against impermissible excess temperatures. It has a fixed switching threshold and prevents exceeding the maximum surface temperature of the inner chamber of 160 °C in the event of a fault. If this temperature is exceeded, the heater turns off.

The safety temperature limiter (TL) provides temperature monitoring through a thermal switch (bimetal switch). If the permissible temperature is exceeded, the heating is switched off and an additional self-holding circuit is activated, which is only reset when the power plug is removed and reconnected. This prevents the heating from being automatically switched on again. When the TL is triggered, an alarm message is displayed on the controller. An annual function check by the operator is recommended, for this a controller test routine is provided (chap. 16.5).

The setpoint can only be set up to the maximum drying temperature of 110 °C / 230 °F.

Control technology ensures that there are no temperature overshoots when heating up.

The interior is hermetically sealed against the heating system. The heating elements are located pre-heating chamber, which is swept with compressed air.

The outer surface of the preheating chamber (category 3) can reach a maximum of 195 °C.

Normal operation when used correctly: Even without taking into account the pressure control, which is also effective in practice, there is no ignition source during the drying process. This also applies in the event that the system is ventilated before the drying process finishes.

Fault: Incorrect loading with inadmissible solvent with a too low ignition temperature: Due to the vacuum, there is no ignition source during the drying process. The drying process could safely be ended. In order to cancel the drying process, it is the chamber must first have cooled to room temperature before ventilation and opening (chap. 9.9.4).

- **Taking into account the volume dependence of the auto-ignition temperature**

The surface temperature is not to exceed 80% of the auto-ignition temperature of the gas or fluid, measured in °C.

Action: The safety margin of 20% of the auto-ignition temperature. is sufficiently large (EN1127-1:2019).

- **Safety pressure monitoring with heater release by pressure switch**

There is no explosive atmosphere in a vacuum. The heater is only released starting with a pressure threshold of 100 mbar.

There is thus always a vacuum ≤ 100 mbar during drying.

The protective measure of ignition source monitoring provides redundant safety during the drying process: There are no hot surfaces at a pressure > 100 mbar, and, when used correctly, after the heater is released the hot surfaces are always below the auto-ignition temperature of permitted materials.

- **Sweeping the area for electrical equipment, the preheating chamber, and the controller housing (triangle instrument box) with compressed air**

The area for electrical equipment, the controller housing and the preheating chamber between the inner and outer chamber where the heater is located, are protected against penetration of explosive atmosphere by a technical ventilation system.

Before each start-up, sweeping takes place with maximum overpressure. When the chamber is in operation, it is continuously swept with a minimum overpressure of 25 Pa (recommendation: >40 Pa). The user must monitor the pressure on the manometer on the chamber front, especially when loading and removing the loading material This reliably prevents explosive atmosphere to reach electrical or electronic parts of the VDL safety vacuum drying oven or at the heater (protection against solvent-containing ambient air).

The compressed air supply line provided by the operator must be equipped with active monitoring of the defined inlet pressure (2 bar).

- **Heater shutdown in the event of component failure**

In case of failure of the controller Pt100 temperature sensor or the heater Pt100 temperature sensor. The heater is turned off. On the controller an alarm message is displayed.

- **Measures for lacking / incorrect maintenance / adjustment / sensor drift**

Proper maintenance requires that the controller sensor is correctly adjusted. The safety temperature limiter (TL) provides sufficient safety against heating sensor drift.

Regular adjustment intervals for the controller sensor (annually) are specified (chap. 26.3).

- **Prevention of electrostatic charges / grounding plan**

All chamber components are at a common potential. The interior parts of the chamber are grounded. The outer powder-coated housing plates have a layer thickness of 60 μ m and are connected with the earth potential via the protective conductor connection.

A detailed grounding plan for the VDL, the pump module, the pump and the installation and loading area is provided, all components are prepared accordingly for grounding: Connections are available to ground the device and accessories. Achieving equipotential bonding according to the grounding plan of the manufacturer is mandatory, see operating manual chap. 6.8.

To create the connection between the vacuum drying oven and the pump, an antistatic PTFE hose is used. All conductive parts have the same electrical potential. Also, the door handle is conductive.

Any clothing, shoes and gloves worn by the user shall be ESD protected.

When installed and operated as intended, there will be equipotential bonding for loading and unloading and there is no risk of charges that are hazardous to operation.

- **Extraction**

Active extraction (technical ventilation) during operation of the VDL is mandatory.

The extraction has to be provided as technical ventilation according to country-specific regulations (TRBS 2152 Part 2 for Germany). It must include the entire installation area of the vacuum drying oven and pump. In normal operation, it affects in particular the loading area of the chamber to limit and reduce any possible explosive atmosphere when loading the device.

Spreading of an explosive atmosphere to non-protected areas is prevented by the prescribed technical ventilation.

Fault: If solvents or solvent vapors inadvertently reach areas of the installation location (e.g. if the material to be loaded or the filled condensate catchpot of the pump fall down), the chamber must be turned off immediately (pull the power plug or operate e.g., a customer's explosion-protected emergency stop switch) in order to prevent explosive atmosphere from penetrating into non-protected areas. The technical ventilation at the installation site reduces the explosive atmosphere.

If, during a fault of the technical ventilation, material containing a solvent is located in the loading area of the chamber, it must be removed immediately. If material containing a solvent is located inside the chamber because it is being loaded at that moment, close the chamber door. The operator must ensure that no explosive atmosphere remains in the area around the chamber when there is no active technical ventilation. Ensure that the operator can manually turn off the chamber immediately (pull the power plug or operate e.g., a customer's explosion-protected emergency stop switch) in order to prevent the chamber from restarting automatically.

If, during a fault of the technical ventilation caused by a power failure, material containing a solvent is located in the loading area of the chamber, the operator must ensure that after the power has been restored, the technical ventilation and sweeping the electrical installation area, preheating chamber and controller housing with maximum overpressure have been active for a defined time (chap. 9.3.2) before turning on the chamber.

- **Sealing**

The area for electrical equipment is sealed so far that an overpressure can be built up. In combination with sweeping with compressed air and the specified technical ventilation (extraction) provided by the operator, the penetration of solvent vapors into the area for electrical equipment, preheating chamber, and controller housing is prevented when loading the device as well as when unloading material that has not completely dried.

- **Authorization levels of the chamber controllers with password assignment**

This makes it easier to restrict the use to trained users.

- **Construction of the pump module and mandatory extraction, requirements for vacuum pumps**

Various constructive features and measures to be taken by the operator prevent solvent vapors from penetrating into the hot pump motor and into the electrical installation area, preheating chamber, and controller housing (triangular instrument box) of the VDL in the event of incorrect operation, e.g. spilling the content of the condensate catchpot of the pump when emptying it:

- Installation of the entire system under extraction (technical ventilation), this must run when emptying.
- Use of Ex pumps corresponding to the zoning is mandatory
- An extraction system provided by the customer must be connected to the port of the pump module. This keeps the concentration in the pump module low
- The condensate collecting tray provided in the pump module prevents leakage

- The grounding plan / equipotential bonding prevents sparking
- The operator is responsible for the correct installation. He must ensure active extraction (technical ventilation) when emptying the condensate catchpot of the pump (with or without a pump module)
- **Spring-mounted safety glass panel**

The VDL vacuum drying oven is equipped with a large-surface area safety valve. The inspection window, consisting of ESG glass (toughened safety glass), is adjustable spring-mounted and serves as a safety valve in the event of explosion. The laminated safety glass pane provides splinter-protection.

Further measures to prevent accidents

- **Indications on the type plate**

For Ex classification, temperature classes and electrical data, please refer to the operating manual Chap. 1.6.

- **Operating manual**

An operating manual is available for each chamber.

- **Temperature monitoring; safety, measurement, and control equipment**

The chamber is equipped with a temperature display, which can be read from outside.

The safety, measuring, and control equipment is easily accessible.

- **Non-ionizing radiation**

Non-ionizing radiation is not intentionally produced, but released only for technical reasons by electrical equipment (e.g. electric motors, power cables, solenoids). The machine has no permanent magnets. If persons with active implants (e.g. pacemakers, defibrillators) keep a safe distance (distance of field source to implant) of 30 cm, an influence of these implants can be excluded with high probability.

- **Safety controller (temperature safety device class 2)**

Temperature limitation via the controller by the safety controller serves to protect the vacuum drying oven, its environment and loading material against impermissible temperature exceeding., that could pose a fire risk. If the entered safety controller temperature is exceeded. The heater is turned off at all poles until manual reset (class 2).

The safety controller must be checked according to its function at appropriate intervals. Test: Set the safety controller value below the temperature set-point. The chamber must not reach the temperature set-point, but must turn off the heater when the safety controller value is reached.

Recommended setting: safety controller mode "Limit".

Visual and additionally activatable audible (buzzer) signals indicate temperature exceeding.

- **Protection against touchable surfaces**

Tested according to EN ISO 13732-1:2008.

- **Floors**

See operating manual chap. 5 for correct installation.

- **Cleaning**

See operating manual chap. 25.

- **Maintenance**

For maintenance instructions for the user, please refer to operating manual chap. 26.

Detailed instructions are included in the service manual for this chamber.

- **Examinations**

The chamber has been inspected by the “Deutsche Gesetzliche Unfallversicherung e.V. (DGUV) (German Social Accident Insurance (DGUV))” (German Social Accident Insurance (DGUV), Testing and Certification Body for Foodstuffs and Packaging Industry in DGUV Test) and bears the GS mark. (Not valid for UL chambers)

3.2 Chamber overview

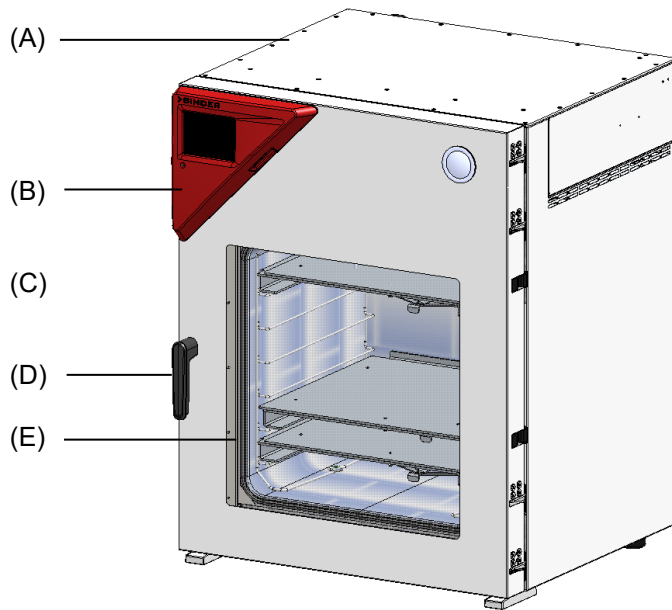

Figure 3: VDL 115 with MB2 controller

- (A) Area for electrical equipment
- (B) Triangular instrument box (controller housing) with chamber controller
- (C) Chamber door
- (D) Door handle
- (E) Elastic-mounted safety glass window

3.3 Triangular instrument box with MB2 controller

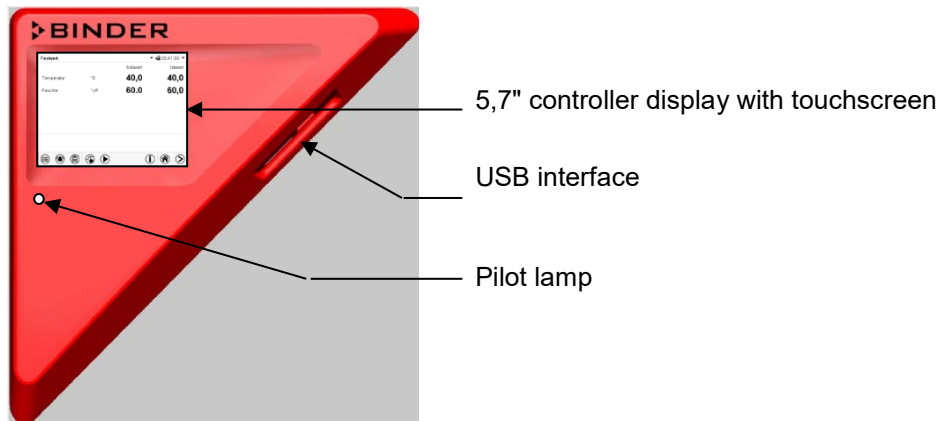

Figure 4: Triangular instrument box (controller housing) with MB2 program controller and USB interface

3.4 Connections on the rear of the chamber

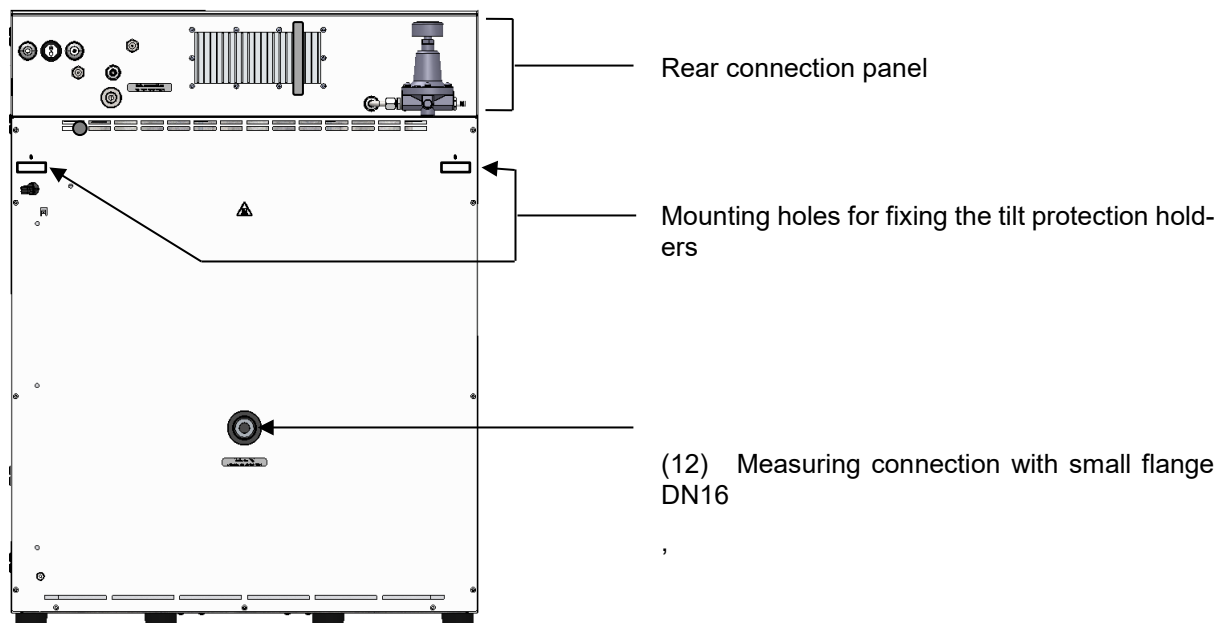
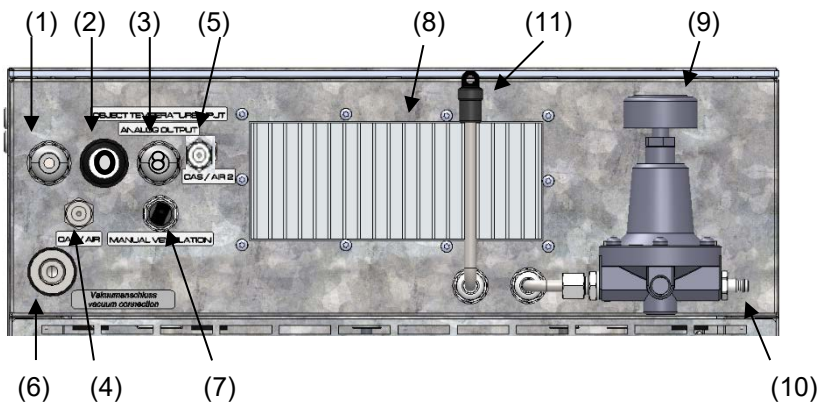
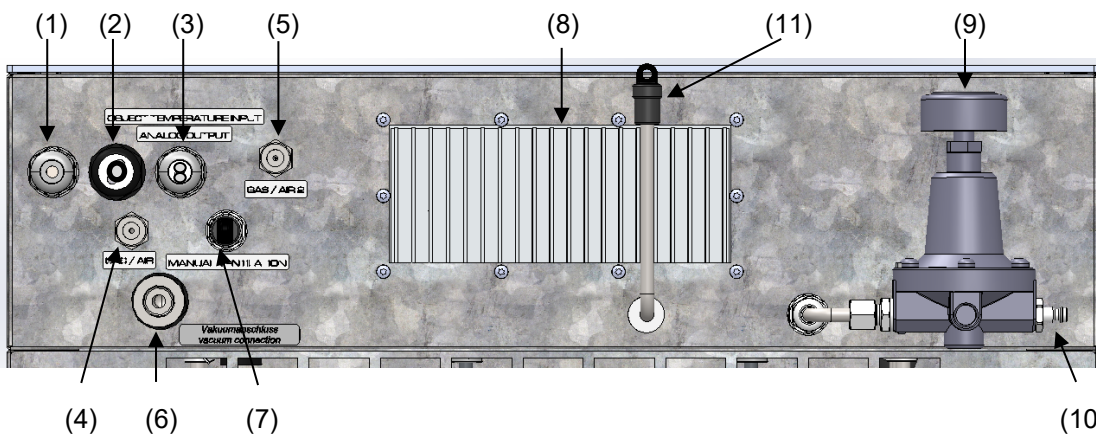

Figure 5: Chamber rear (example: VDL 115)



VDL 23



VDL 56

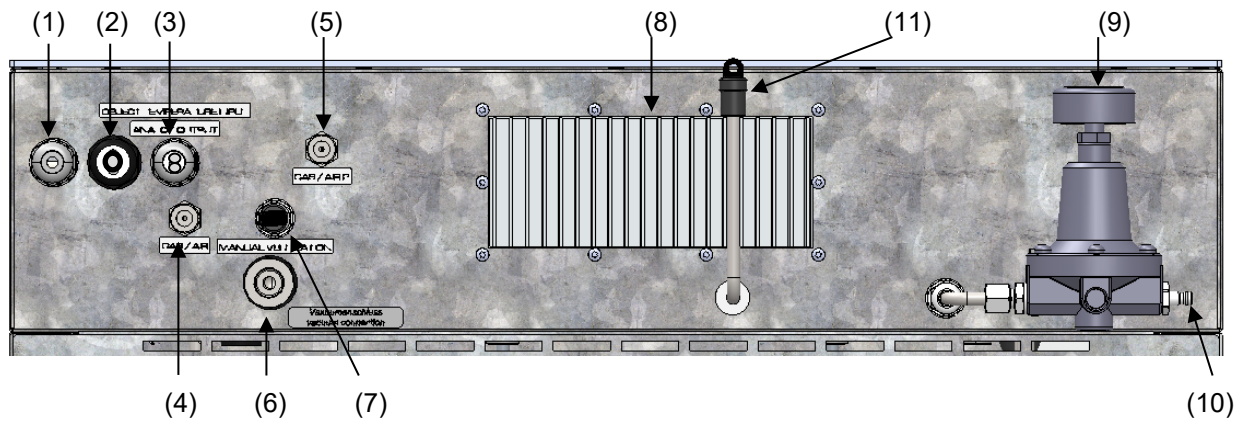

VDL 115

Figure 6: Rear connection panel VDL with options

- (1) Power cable
- (2) Connection cable to Ethernet interface for computer communication
- (3) 2 connection sockets (3a) and (3b):
 - (3a) Connection "Object temperature input" (option) for optional object temperature display
 - (3b) Connection "Analog output" (option) for optional analog outputs for temperature and pressure
- (4) Universal connection for inert gas / ambient air "GAS/AIR", adapter with hose olive \varnothing 8 mm / 0.31 in
- (5) Additional universal connection for inert gas / ambient air "GAS/AIR 2" (option), adapter with hose olive \varnothing 8 mm / 0.31 in
- (6) Vacuum connection with small flange DN16
- (7) Plug „Manual ventilation“ for emergency ventilation in case of power failure
- (8) Heat sink
- (9) Pressure regulator for sweeping / overpressure
- (10) Compressed air connection for sweeping / overpressure
- (11) Outlet with sweeping plug for compressed air sweeping prior to start-up

3.5 Area classification, information for the zone classification

The operator is to classify the zones. The following areas are identified below:

- Unprotected areas. The spread of an explosive atmosphere to unprotected device parts must be reliably prevented.
- Areas where, depending on the substances used, explosive atmospheres may occur on a rare and temporary basis. The creation of a zone outside the defined areas must be reliably prevented.

3.5.1 Area classification inside the chamber

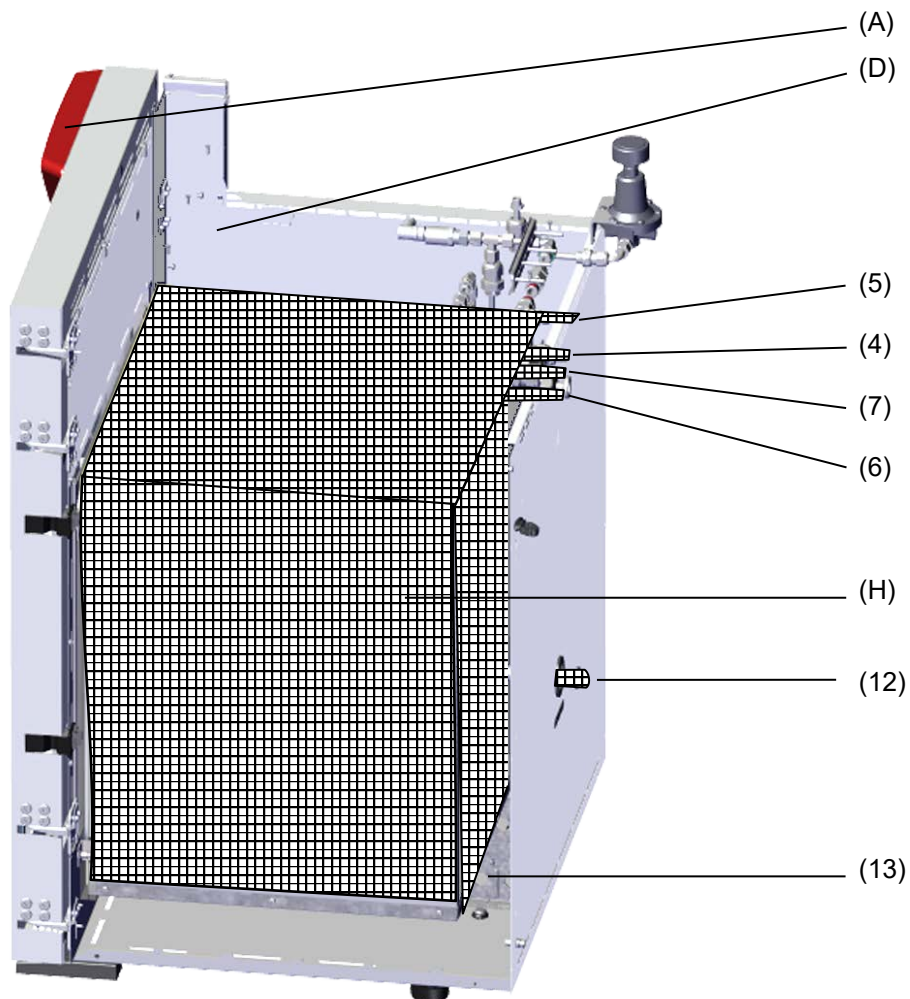



Figure 7: Area classification of the closed chamber
(view without housing, insulation, heater and outer chamber)

- (A) Controller housing (swept with compressed air)
- (D) Electrical installation area (swept with compressed air)
- (H) Inner chamber (usable volume)
- (7) Plug "Manual ventilation" for emergency ventilation
- (4) Universal connection for inert gas / ambient air "GAS/AIR"
- (5) Additional universal connection for inert gas / ambient air "GAS/AIR 2" (option)
- (6) Vacuum connection
- (12) Measuring connection
- (13) Preheating chamber between the inner and outer chamber (swept with compressed air)

Occurrence of an explosive atmosphere:

 Occasionally: Inner chamber with tubing / line to the vacuum pump, and connections

3.5.2 Area classification in the surroundings of the chamber

The VDL vacuum drying oven, with the exception of the power plug, the plug connection of the optional analog outputs, and the plug connection for Ethernet ,, is classified in category 3 in relation to the environment. It may be installed in areas in which explosive atmospheres may occur on a rare and temporary basis.

The **chamber plug (power plug)** is unprotected because it must be disconnected in case of an emergency to completely separate the chamber from the power supply. Therefore, the electrical connection must be established outside a zone.

The **plug connection for Ethernet** as an interface for computer communication is unprotected and therefore must be established outside a zone

With optional analog outputs: The **plug connection of the analog outputs** is unprotected and must therefore be established outside a zone.

Spreading of an explosive atmosphere, which may occur on a rare and temporary basis, to unprotected areas must be reliably prevented by measures of the operator. In particular, this includes a sufficiently dimensioned one technical ventilation according to country-specific regulations (TRBS 2152 Part 2 for Germany) and compressed air sweeping).

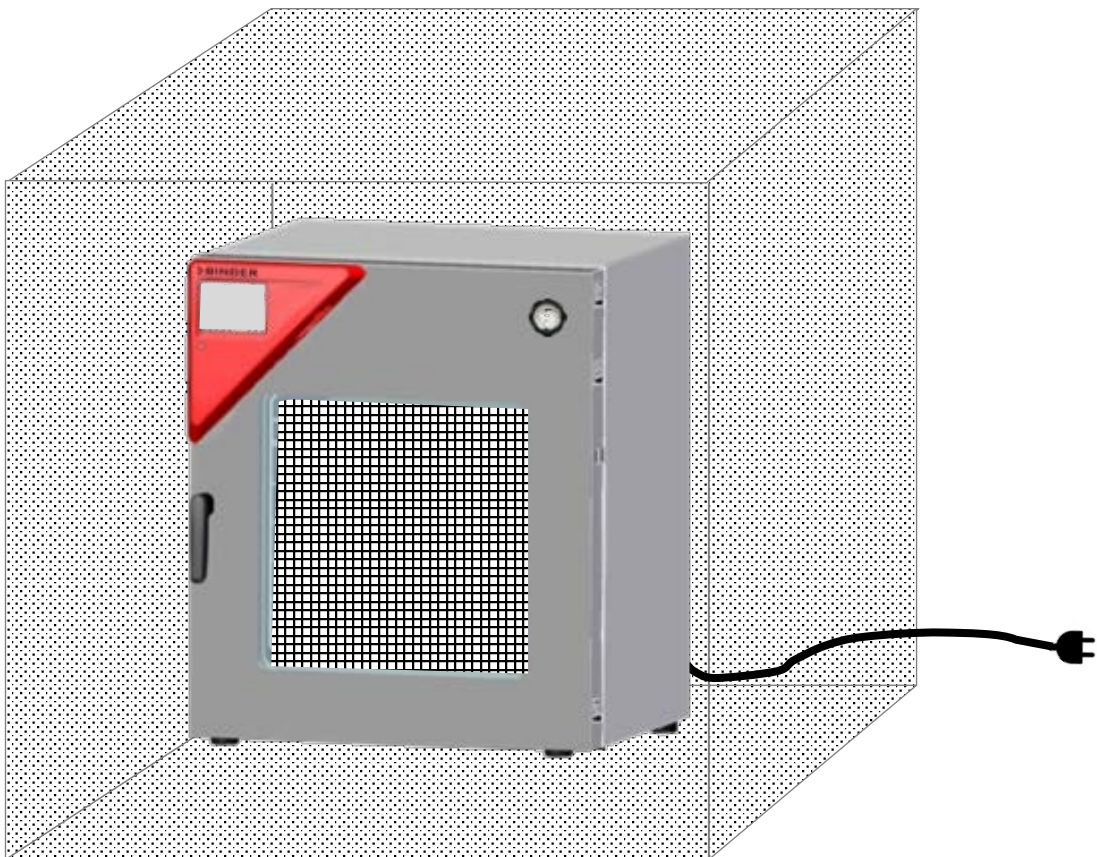





Figure 8: Area classification in the surroundings of the chamber (schematic representation, standard device)

Occurrence of an explosive atmosphere:

-  Occasionally: in the chamber interior with tubing
-  On a rare and temporary basis: in the ambiance of the chamber, with the exception of the power plug, the plug connection of the optional analog outputs, and the plug connection for Ethernet
-  Never (unprotected areas): Connection location of the power plug, the plug connection of the optional analog outputs, and the plug connection for Ethernet

3.5.3 Area classification in the surroundings of the chamber: extraction lead to the pump, location of the pump

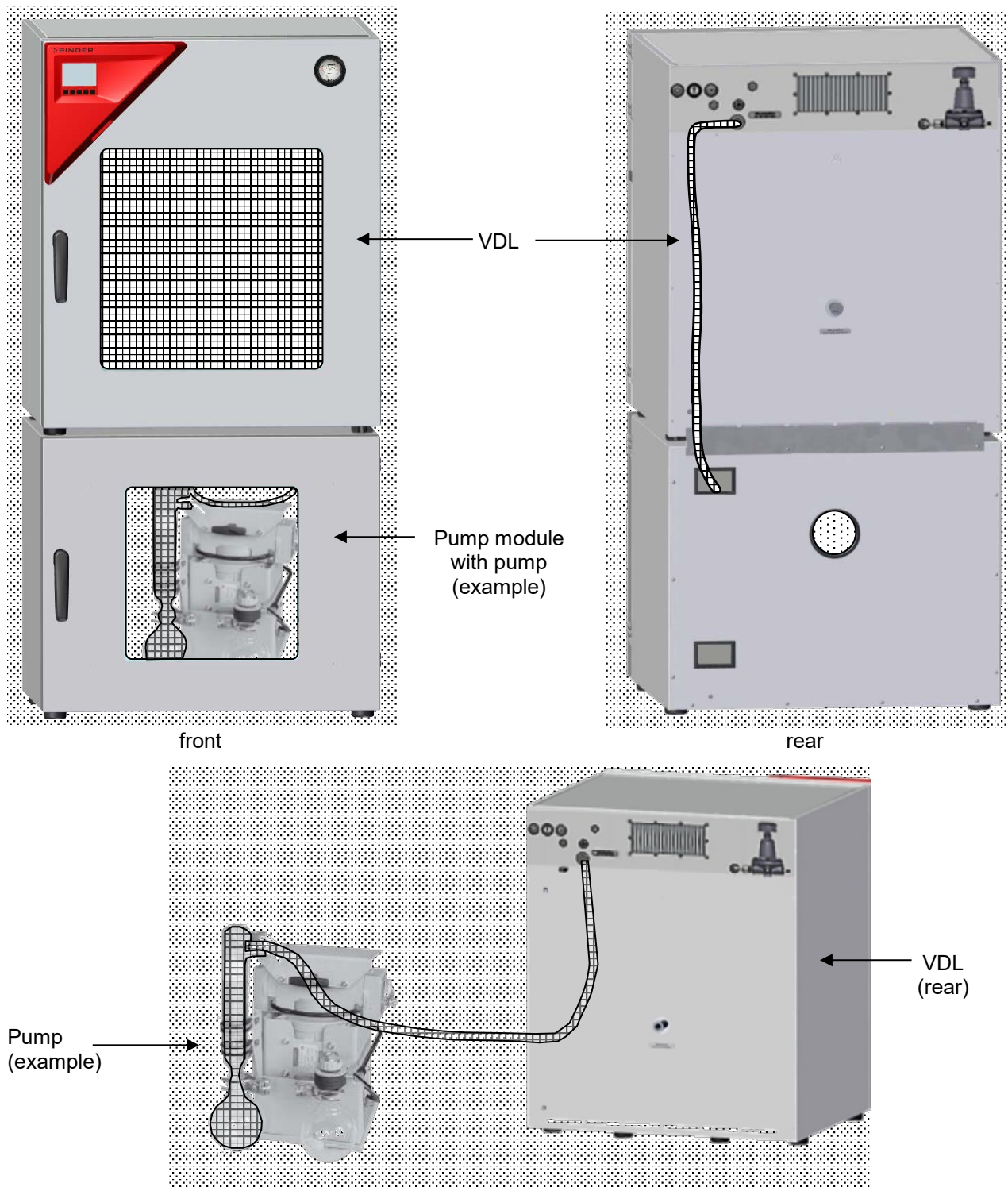



Figure 9: Area classification in the surroundings of the chamber during operation (example)

Occurrence of an explosive atmosphere:

 Occasionally: interior of VDL, line to the vacuum pump, pump

 On a rare and temporary basis: surroundings of VDL and pump, interior of the pump module

4. Completeness of delivery, transportation, storage, and installation



4.1 Unpacking, and checking equipment and completeness of delivery

After unpacking, please check the chamber and its optional accessories, if any, based on the delivery receipt for completeness and for transportation damage. Inform the carrier immediately if transportation damage has occurred.

The final tests of the manufacturer may have caused traces of the shelves on the inner surfaces. This has no impact on the function and performance of the chamber.

Please remove any transportation protection devices and adhesives in/on the chamber and on the doors and remove the operating manuals and accessory equipment.

Due to different installation heights above sea level, a slight negative pressure in the inner chamber may prevent the door from being opened. Therefore, after unpacking the chamber, remove the plug "Manual ventilation" (7) for emergency ventilation from the tube to ensure pressure equalization. **After this, thoroughly reinstall the plug.**

| | |
|--|---|
|  | <div style="background-color: yellow; text-align: center; padding: 5px;">  CAUTION </div> <p>Risk of injury due to sliding or tilting of the chamber in case of improper lifting. Injuries, damage to the chamber.</p> <ul style="list-style-type: none"> ⊘ Do NOT lift the chamber using the door or the handle. ⊘ Do NOT use technical equipment to lift the chambers. ➤ Lift chambers size 23 and 56 from the pallet at the four lower corners with the aid of 4 people. ➤ Lift chambers size 115 from the pallet with the aid of 6 people. |
|--|---|

If you need to return the chamber, please use the original packing and observe the guidelines for safe lifting and transportation (chap. 4.2).

For disposal of the transport packing, see chap. 27.1.

If you ordered the optional pump module with a chemical membrane pump, the pump will be delivered in a separate box and must be fitted into the pump module and connected at the place of installation (see chap. 6.5.3).





Note on second-hand chambers (Ex-Demo-Units):

Second-hand chambers are chambers that were used for a short time for tests or exhibitions. They are thoroughly tested before resale. BINDER ensures that the chamber is technically sound and will work flawlessly.

Second-hand chambers are marked with a sticker on the chamber door. Please remove the sticker before commissioning the chamber.

4.2 Guidelines for safe lifting and transportation

After operation, please observe the guidelines for temporarily decommissioning the chamber (chap. 27.2).

| | |
|---|--|
|    |  CAUTION |
| | <p>Risk of injury due to sliding or tilting of the chamber in case of improper transport or by lifting heavy loads.</p> <p>Injuries, damage to the chamber.</p> <ul style="list-style-type: none"> ➤ Transport the chamber in its original packaging only. ➤ For moving or shipping, secure the chamber with transport straps. ⊘ Do NOT lift or transport the chamber using the door or handle. ➤ Lift chambers size 23 and 56 at the four lower corners with the aid of 4 people. ➤ Lift chambers size 115 with the aid of 6 people. |

- Permissible ambient temperature range during transport: -10 °C / 14 °F to +60 °C / 140 °F.

You can order transport packing for moving or shipping purposes from BINDER Service.

4.3 Storage

Intermediate storage of the empty chamber is possible in a closed and dry room. Observe the guidelines for temporary decommissioning (chap. 27.2).

- Permissible ambient temperature range during storage: -10 °C / 14 °F to +60 °C / 140 °F.
- Permissible ambient humidity: max. 70 % r.h., non-condensing

When after storage in a cold location you transfer the chamber to its warmer installation site, condensation may form. Before start-up, wait at least one hour until the chamber has attained ambient temperature and is completely dry.

5. Location of installation and ambient conditions

5.1 General requirements for installation

Set up the vacuum drying oven on a flat, even and non-flammable surface, free from vibration, in a well-ventilated, dry location and align it using a spirit level or laser. The site of installation must be capable of supporting the chamber's weight (see technical data, chap. 28.3). The chambers are designed for setting up inside a building (indoor use). Provide active extraction (technical ventilation, chap. 5.2.2).

Minimum distances

- Distance between several chambers of the same size: 250 mm / 9.8 in
- Wall distances to rear: 100 mm / 3.9 in
- Lateral wall distances: 70 mm / 2.76 in
- Spacing above and behind the chamber: 100 mm / 3.9 in.

| | |
|---|---|
|  | NOTICE |
| | <p>Danger by stacking. Damage to the chambers.</p> <p>∅ Do NOT place vacuum drying ovens on top of each other.</p> |

Permissible areas

The **VDL vacuum drying oven** may be installed in areas in which explosive atmospheres may occur on a rare and temporary basis. The entire chamber with the exception of the power plug is classified in category 3 in relation to the environment.



The **chamber plug (power plug)** is unprotected, therefore the electrical connection must be established outside a zone.

The **plug connection for Ethernet** is unprotected and therefore must be established outside a zone.

With optional analog outputs: The **plug connection of the analog outputs** is unprotected and must therefore be established outside a zone.

VDL vacuum drying ovens are not intended for installation in a Zone 1 or 0. The chamber must not be installed or operated in an occasionally or continuously / for long periods / frequently potentially explosive area. Measures must be taken to prevent the spread of explosive atmospheres to unprotected areas. Spreading of an explosive atmosphere to the unprotected areas must be reliably prevented. Observe the information on zone classification (chap. 3.5).

Observe the instructions on extraction (technical ventilation, chap. 5.2.2). When installed as intended, there is no Zone 1 or 0 in the vicinity of the chamber.

| | |
|---|--|
|  |  DANGER |
| | <p>Explosion hazard by penetration of an explosive atmosphere to unprotected areas. Serious injury or death from burns and / or explosion pressure.</p> <p>∅ Do NOT operate the chamber in occasionally or continuously / for long periods / frequently potentially explosive areas. It is not intended for installation in a zone 1 or 0.</p> <ul style="list-style-type: none"> ➤ Make sure that there are NO combustible dusts in the vicinity of the chamber ➤ Make sure that air-solvent mixtures are NOT occasionally or continuously / for long periods / frequently in the vicinity of the chamber. ➤ Strictly observe the relevant legal regulations about how to select an appropriate location. |

The operator is responsible for the correct installation of the pump or other equipment (zone classification). Sufficient extraction (technical ventilation, chap. 5.2.2) also in the event of an error (e.g. damage / overfilling the condensate catchpot of the pump, or spilling or dropping containers or material to be loaded with solvents) must be provided.

The operator is responsible to use suitable pumps for pumping from zone 0 or 1.

| | |
|---|--|
|  | <p>Follow country-specific regulations for explosion protection.</p> |
|---|--|



If you ordered the optional pump module with chemical membrane pump, the vacuum pump will be delivered in a separate box and must be fitted into the module and connected at the place of installation (chap. 6.5.3).

Electrical connection

To completely separate the chamber from the power supply, you must disconnect the power plug. Install the chamber in a way that the power plug is easily accessible and can be easily pulled in case of danger.

It is also possible to use a customer's explosion-protected emergency stop switch or a comparable power disconnecter.

The chamber plug (power plug) is unprotected because it must be disconnected in case of an emergency to completely separate the chamber from the power supply. therefore, the electrical connection must be established outside a zone.

| | |
|---|--|
|  |  DANGER |
| | <p>Explosion hazard due to sparking when disconnecting an improper electrical connection.</p> <p>Serious injury or death from burns and / or explosion pressure.</p> <ul style="list-style-type: none"> ➤ Make sure that the electrical connection is located outside a zone t. ➤ Connect the plug outside the installation area of the VDL and the pump. Take into account the information on zone classification (chap. 3.5.2) |

For the user there is no risk of temporary overvoltages in the sense of EN 61010-1:2010.

5.2 Ventilation and extraction (technical ventilation)

5.2.1 Ventilation for heat removal in normal operation

Install the vacuum drying oven in a well-ventilated place.

| | |
|--|---|
|  | NOTICE |
| | <p>Danger of overheating due to lack of ventilation.</p> <p>Damage to the chamber.</p> <ul style="list-style-type: none"> ➤ Do NOT set up chambers in non-ventilated recesses. ➤ Ensure sufficient ventilation for dispersal of the heat. ➤ Observe the prescribed minimum distances when installing the chamber (chap. 5.1) |

5.2.2 Technical ventilation during chamber operation and when emptying the condensate catchpot of the pump

Provide active extraction at the location of installation. The extraction shall be provided as technical ventilation according to country-specific regulations (TRBS 2152 Part 2 for Germany). It must include the entire installation area of the chamber.

In normal operation, it affects in particular the loading area of the chamber for the spatial limitation and reduction of any possible explosive atmosphere when loading the chamber. Also in the event of a fault (e.g. if the material to be loaded or the filled condensate catchpot of the pump falls down), it causes spatial limitation and reduction of any possible explosive atmosphere.

Extraction must be active during the entire operation of the chamber and when handling the condensate catchpot of the pump. Extraction must lead into an explosion-proof area.

The operator must ensure active extraction before starting up the chamber. Extraction must be provided during the entire operation of the chamber as well as when handling the condensate catchpot of the pump. This ensures that solvent vapors never reach unprotected areas or accumulate in an impermissible manner.

If the technical ventilation fails, the power to the vacuum drying oven must be switched off. It must be ensured that the device can be switched off by the operator using an explosion-protected device: Pull out the power plug or operate e.g., a customer's explosion-protected emergency stop switch.

5.2.3 Air supply (breaking the vacuum) during operation with inert gas

When operating the VDL vacuum drying oven with inert gas correctly follow the technical ventilation measures according to the local and national regulations relevant for your country (for Germany: DGUV guidelines 213-850 on safe working in laboratories, issued by the employers' liability insurance association).

5.3 Equipotential bonding

The accessible installation and operating surface of the chamber must be electrically conductive. This installation and operating surface must be connected to the vacuum drying oven and other equipment (e.g. Pump module, vacuum pump) according to the grounding concept. Provide cyclic measurements.

For the grounding concept see chap. 6.8.

When inserting or loading objects into the loading area, note that there may be a potential equalization. The personal protective equipment (PPE) of the operating personnel must be implemented ESD protected.

5.4 Ambient conditions

- Permissible ambient temperature during operation: +18 °C / 64 °F to +32 °C / 90 °F.



The ambient temperature should not be substantially higher than the indicated ambient temperature of +22 °C +/- 3 °C / 71.6 °F +/-5.4 °F to which the specified technical data relate. Deviations from the indicated data are possible for other ambient conditions.

- Permissible ambient humidity: 70 % r.h. max., non-condensing.
- Installation height: max. 2000 m / 6562 ft above sea level.

The maximum permissible ambient temperature of the vacuum pumps delivered by BINDER is 40 °C / 104 °F.

5.5 Compressed air supply for sweeping the area for electrical equipment, the preheating chamber, and the controller housing

Before commissioning the chamber, connect the vacuum drying oven to the compressed air supply (chap. 6.3).

The compressed air supply line provided by the operator must be equipped with active monitoring of the defined inlet pressure (2 bar), which clearly indicates a drop and increase in the inlet pressure outside the permissible tolerance of ± 0.2 bar.

5.6 Fire extinguisher



During operation a fire extinguisher must be available.

5.7 Lightning protection device

The building in which the vacuum drying oven is installed must have a lightning protection system. All internal connections in the operator's building must contain lightning protection in accordance with EN/IEC 62305-3.

Lightning protection measures must be taken in order to prevent melting and spraying effects. The operator's zone classification shall be used to plan lightning protection measures. The lightning discharge paths must be designed so that heat or ignitable / spray sparks cannot become the ignition source for an explosive atmosphere.

6. Installation and connections

The chambers may only be installed, connected, and commissioned by specialist personnel. Specialist personnel must have knowledge of the types of ignition protection and regulations and ordinances for equipment used in hazardous areas (Ex areas).

Verify whether the Ex classification (Ex classification label on the type plate) is suitable for the application.

6.1 Vacuum expansion racks and rack holders



Vacuum expansion racks and rack holders can easily be removed from the chamber. This offers the advantage of an inner chamber with smooth walls, which is easy to clean.

Inserting or loosening an expansion rack and inserting or removing the rack holders may only be done in the absence of solvents and under extraction (technical ventilation).

The rack holders can only be removed from the chamber after removing the expansion racks.

Rack holder installation: Align the rack holders to the cams in the bottom of the inner chamber and insert them.

Prior to insertion check the expansion racks and rack holders for corrosion. If corrosion is detected, the affected element must not be used.

| | |
|--|---|
|  |  DANGER |
| <p>Explosion hazard due to creation of mechanical sparks in an explosive atmosphere. Serious injury or death from burns and / or explosion pressure.</p> <ul style="list-style-type: none"> ➤ Insert or remove the expansion racks and rack holders only in the absence of solvent. ➤ Insert or remove the expansion racks and rack holders only with active extraction (technical ventilation). ➤ Prior to inserting the expansion racks and rack holders, check them for corrosion. ⊘ Do NOT use corroded expansion racks and rack holders. | |

The vacuum expansion racks made of aluminum (also optionally available in stainless steel) allow low-loss heat transfer to the material. The strong tension causes the racks to fit tightly against the interior wall and their large-surface contact area ensures rapid and effective heat transfer.

The removable rack holders allow for easy positioning.

You can remove the expansion racks for easy cleaning. Do not remove them too often in order to prevent wear.



Figure 10: Operating the expansion racks

- Pushing the locking lever: The expansion rack is released and can be removed.
- Pulling the locking lever: The expansion rack is pressed against the inner chamber walls.

| | |
|---|---|
|  | <p>Remove or insert the vacuum expansion racks only when the chamber is empty and has cooled down. NO explosive atmosphere must be present. Active extraction (technical ventilation) is mandatory.</p> |
|---|---|



Following each new tightening of an expansion rack, check that the lateral parts of the rack fit closely over their whole surface to the inner chamber wall. This is necessary in order to ensure the specified temperature exactitude.



NOTICE

Risk of invalid calibration due to modified heat transmission when changing between aluminum and stainless-steel racks.

Undefined heating behavior.

- ∅ Do NOT change between aluminum and stainless-steel racks
- ∅ Use the supplied expansion racks only.

6.2 Mounting the pressure regulator

The pressure regulator is included with the chamber and must be mounted on the chamber rear

Accessory pack for mounting the pressure regulator

(a) pressure regulator

(b) tube

(c) 6 screws

(d) brass plug for compressed air connection

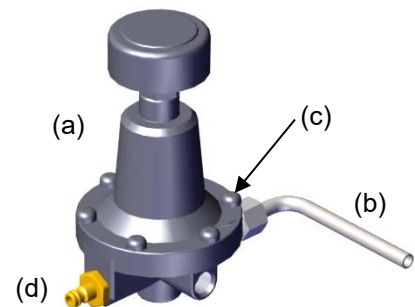

(e) bracket (pre-assembled on the chamber rear)



(f) cable connector (pre-assembled on the chamber rear)

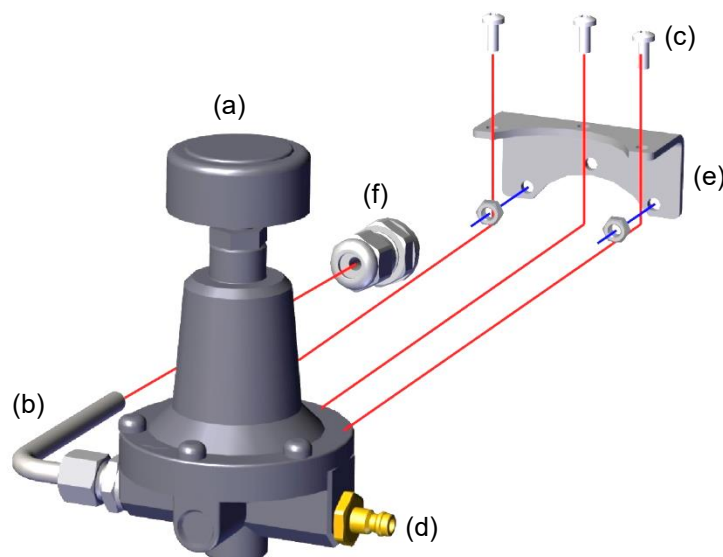
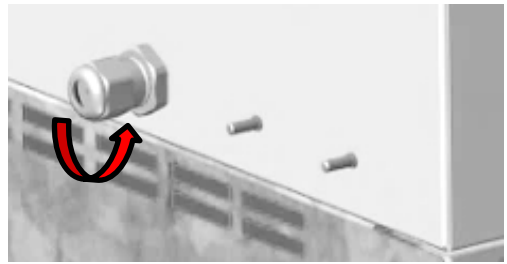

Figure 11: Mounting the pressure regulator on the chamber rear

Proceed in the following order:

- Unscrew the nut of the cable connector (f) a little so that it is loose



- Unscrew the three screws (c) pointing to the chamber from the pressure regulator

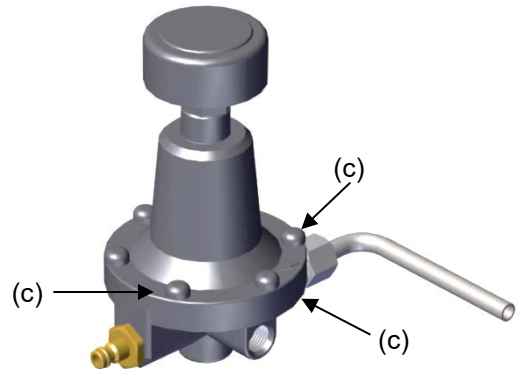

- Guide the tube (b) through the cable connector (f)
- Fix the three screws (c) together with the bracket (e) on the pressure regulator
- The bracket is pre-assembled on the chamber rear (not shown)

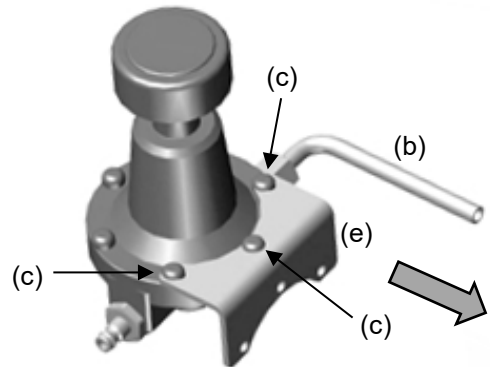

- Tighten the nut of the cable connector (f) which points to the chamber clockwise with a tool so that it can no longer be loosened by hand

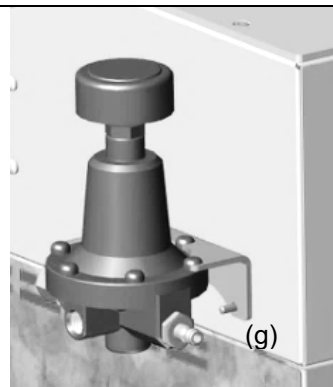
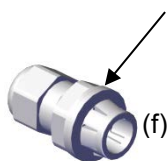

6.3 Connecting compressed air supply for sweeping the area for electrical equipment, the preheating chamber, and the controller housing

The compressed air flows through the area for electrical equipment, the preheating chamber, and the controller housing, which prevents a possible concentration of a solvent-containing atmosphere in the presence of live electrical components and the hot heater surface.

Use only dry compressed air.

In order to avoid that any oil coming from the compressed-air piping enters the vacuum drying oven, the compressor of the compressed air system must be equipped with an oil separator, or the compressed air system must be constructed oil-free.

Connection:

Before commissioning, the pressure regulator on the chamber rear must be connected to a customer's compressed air line (compressed air network).



Connection: Plug connector for compressed-air quick coupling NW5 (customer side) for the connection via the existing 5 mm brass plug for compressed air connection.

An inlet pressure of 2 bar must be provided for the compressed air sweeping. The compressed air supply line provided by the operator must be equipped with monitoring which clearly indicates a drop and increase in the inlet pressure outside the permissible tolerance of ± 0.2 bar.



Figure 12: Compressed air connection on the pressure regulator

If solvent-containing air penetrates the electrical areas of the chamber or the preheating chamber, explosions may result.

| | |
|---|---|
|  |  DANGER |
| <p>Explosion hazard by solvent-containing air penetrating the electrical area of the chamber or the preheating chamber. Serious injury or death from burns and / or explosion pressure.</p> <ul style="list-style-type: none"> Ø Make sure that the air for the compressed air supply is NOT taken from explosive atmospheres. Ø Ensure that the compressed air supply line provided by the operator is equipped with active monitoring of the defined inlet pressure. | |

| | |
|---|---|
|  | <p>Do NOT start the VDL vacuum drying oven when the chamber is not connected to the compressed air supply, or if the specified overpressure is not reached.</p> |
|---|---|

6.4 Pump module (option)

| | |
|---|---|
|  | <p>The mounting instructions Art. no. 7001-0401 supplied with the pump module describe how to mount the vacuum drying oven onto the pump module and installing the suction line into the pump module.</p> |
|---|---|



Figure 13: VDL mounted on pump module
(example size 115)

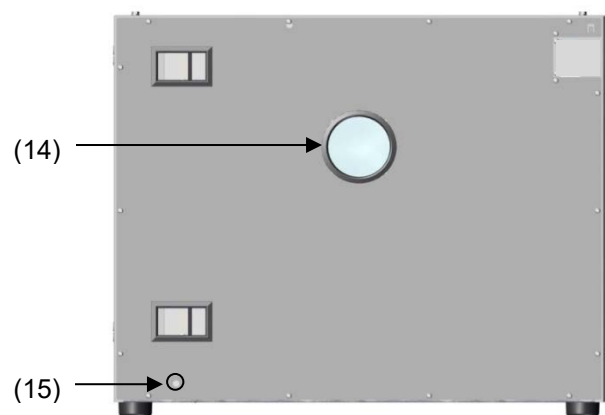

Figure 14: Pump module, rear view
(example size 115)



- (14) Connection to extraction
- (15) Fixation screw fitting for grounding

The following steps 6.4.1 to 6.4.3 are described in detail in the mounting instructions Art. no. 7001-0401. Please proceed accordingly.

6.4.1 Mounting



- Placing the vacuum drying oven on the vacuum module
- Mounting the connecting plate
- Installing the suction line: Hose connection at the VDL vacuum connection (11) and fixing the hose at the housing rear
- Installing the condensate collecting tray

Inappropriate execution of the connections can lead to the risk of explosion.

| | |
|--|---|
|   |  DANGER |
| | <p>Danger of ignition and explosion by inappropriate installation. Serious injury or death from burns and / or explosion pressure.</p> <ul style="list-style-type: none"> ➤ It is obligatory to follow the instructions of the mounting instructions Art. no. 7001-0401 regarding correct installation. ➤ Observe the safety advice as in chap. 1.7.3. |

6.4.2 Achieving equipotential bonding acc. to the grounding plan

- The conductive connection between the VDL and the pump module is established by mounting the connecting plate.
- To establish a conductive connection between the vacuum pump and the pump module a grounding cable is supplied, which is already fixed at the pump module. It will be connected to the pump.
- To establish a conductive connection between the condensate collecting tray and the pump module the front edge of the tray is screwed on the front of the vacuum module
- To establish a conductive connection between the pump module and the conductive surface of the installation site a grounding cable is supplied with the pump module. It is screwed on the fixation screw fitting for grounding of the pump module and connected to the conductive surface of the installation site.

| | |
|--|--|
|   |  DANGER |
| | <p>Explosion hazard due to electric sparking due to missing or improperly implemented equipotential bonding. Serious injury or death from burns and / or explosion pressure.</p> <ul style="list-style-type: none"> ➤ Connect all elements in the installation and loading area (VDL / pump module / pump) with the conductive surface and/or with each other. Proceed according to the grounding plan in chap. 6.8. ➤ For installation of the pump module proceed acc. to the mounting instructions of the pump module (Art. no. 7001-0401). ➤ Before commissioning, measure the equipotential bonding after first setting up the VDL and implementing all described measures for establishing the equipotential bonding ➤ Provide cyclic measurements of the equipotential bonding. |

6.4.3 Connection of an extraction system at the pump module



Avoid the solvent accumulation in the pump module as this would cause the pump module to become an occasionally or continuously / for long periods / frequently potentially explosive area (Zone 0 or 1). The VDL vacuum drying oven located on top of the module is constructed in device category 3 in regards to its surroundings.



DANGER

Explosion hazard due to the spread of an explosive atmosphere to unprotected chamber parts and ignition due to electric sparking or hot surfaces

Serious injury or death from burns and / or explosion pressure.

- Provide active extraction (technical ventilation according to country-specific regulations – TRBS 2152 Part 2 for Germany) prior to commissioning the chamber.
- Extraction must include the entire installation area of the vacuum drying oven and pump module.
- Connect an extraction system to the provided port on the rear of the pump module.

6.5 Vacuum connection

Connect the vacuum drying oven to a vacuum pump or to a domestic vacuum system. For this purpose, the vacuum connection (6) with small flange DN16 must be connected to the back of the chamber at the top with the vacuum pump or domestic vacuum system via a vacuum suction hose or a fixed vacuum pipe.

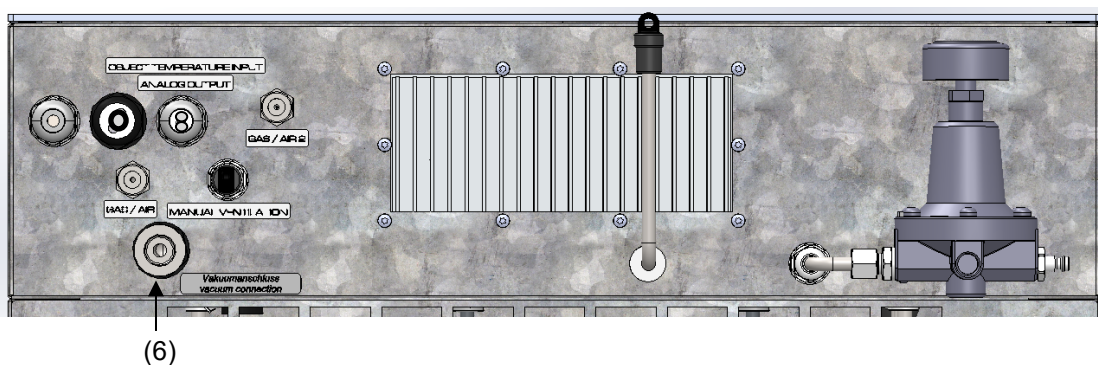

Figure 15: Position of the Vacuum connection (6) on the chamber rear (example size 56)

When using a vacuum suction hose BINDER recommends the connection kit for the VP4 pump from BINDER (chap. 6.5.5). The optional pump module (chap.) provides an appropriate hose port on the rear.

6.5.1 Instructions for using vacuum pumps



Vacuum pumps with a suction capacity of 1-30 m³/h are suitable for the VDL vacuum drying oven.



For use of vacuum pumps in the European Union, note the following points:

- Units that will be operated in potentially explosive areas have to meet the requirements of ATEX Directive 2014/34/EU. Observe the safety instructions in chap. 1.7.

- If combustible solvent will be introduced into the inner chamber, the vacuum pump must be constructed in a suitable explosion-proof manner. The mixtures extracted from the drying chamber must be carried away making sure that there is no danger by ignition of these atmospheres.

| | |
|---|--|
|  | Follow the safety instructions of the pump manufacturer. |
|---|--|



In the event of an error, sparking in the pump motor or the switching elements, electrostatic discharges, as well as hot pump parts can ignite solvent vapors. Minimize this risk by using an ATEX Directive 2014/34/EU compliant vacuum pump suitable for suction from Zone 0 or 1 and, if appropriate, from the zone of its installation site.

| | |
|--|---|
|   |  DANGER |
| <p>Explosion hazard caused by emerging solvent vapors, which can ignite due to sparking in the pump motor or the switching elements, electrostatic discharges and hot pump parts.</p> <p>Serious injury or death from burns and / or explosion pressure.</p> <ul style="list-style-type: none"> ➤ Use only suitable, explosion-proof pumps ➤ Operate the pump in a stationary position and secure it so it is immobile. ➤ Make sure that the suction line to the vacuum connection (6) is installed securely attached and conductive. ➤ Avoid that the exhaust pipe conducts ignitable solvent concentrations by sufficient solvent condensation e.g., in an exhaust waste vapor condenser ➤ Make sure that the exhaust pipe is installed securely attached and conductive in case it may still conduct ignitable solvent concentrations. ➤ Ensure equipotential bonding between the pump housing and the housing of the VDL vacuum drying oven via the connected equipment grounding conductors of both units. <p>When using ATEX Directive 2014/34/EU non-compliant pumps:</p> <ul style="list-style-type: none"> ➤ Provide a current-dependent, delayed protective device for the pump (for the triggering time of this protective device, see the manufacturer's specifications). The protective and monitoring device must not be able to independently turn on again or be released. ➤ Install the switch gear box outside the hazardous area or provide it with explosion protection. | |



| | |
|---|---|
|  | The ATEX Directive 2014/34/EU compliant pumps offered by BINDER provide an integral protective device and an integral explosion proof switch. |
|---|---|

| | |
|---|---|
|  | Make sure that the vacuum source is designed for a gas inlet temperature corresponding to the used drying temperature, or take appropriate measures to cool down the extracted vapor before it enters into the vacuum source. |
|---|---|

Observe the permissible gas inlet temperature of the vacuum pump in use. Do NOT exceed this temperature. If the gas inlet temperature is too high and then becomes even warmer by compression in the pump, the resulting temperature (of the gas-solvent mixture inside the pump) could exceed the solvent's temperature class and auto-ignition temperature .

| | |
|--|---|
|  |  DANGER |
| <p>Fire and explosion hazard by exceeding the auto-ignition temperature of the solvent with a too high gas inlet temperature.</p> <p>Damage to the vacuum pump. Serious injury or death from burns and / or explosion pressure.</p> <ul style="list-style-type: none"> ➤ Do NOT exceed the maximum gas inlet temperature of the pump. Adjust the temperature set-point accordingly. ➤ With a higher set-point temperature, take appropriate measures to cool down the extracted vapor before it enters into the vacuum pump. | |

Extracted vapors can have a health damaging and/or corrosive effect on the chamber and pump.

| | |
|--|--|
|  |  CAUTION |
| <p>Health hazard due to release of extracted vapors.</p> <p>Corrosion of oven and pump. Damage to health.</p> <ul style="list-style-type: none"> ➤ Conduct the extracted vapors e.g., into a fume extractor facility. Connect a suitable hose to the vacuum pump outlet that may be located in the pump module. | |

To avoid condensation inside the chamber and in the suction system, select an appropriate vacuum source to ensure its sufficient performance in relation to the released amount of steam. Coordinate drying temperature, suction performance of the vacuum source and the amount of loading material.

6.5.2 Vacuum pump VP4 (option)

. The VP4 chemical membrane pump is located in a separate transport packaging. It is delivered as complete pump stand with a separator and an exhaust waste vapor condenser.

We recommend to install the vacuum pump in the optional pump module. For installation of the pump, please refer to chap. 6.5.3.

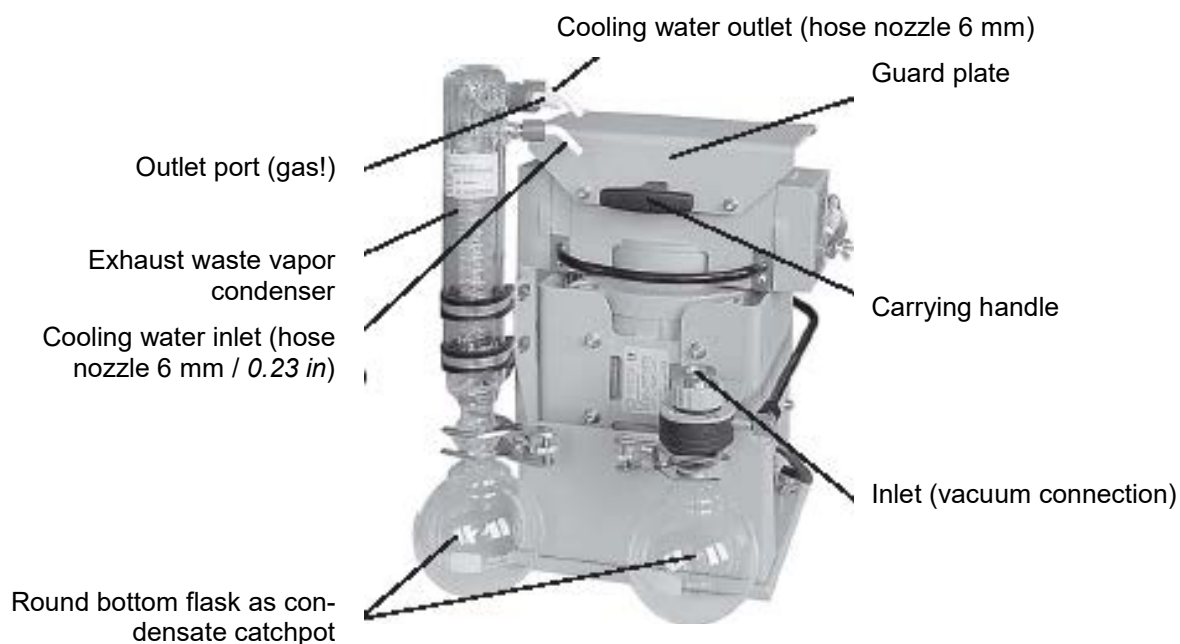



Figure 16: Vacuum pump VP 4 (MZ2C EX)

Defining the zone of the installation site of the vacuum pump (Directive 1999/92/EC)

If the pump module is defined as Zone 1, the operating chamber of the vacuum pump must be swept with inert gas. A flow of at least 1 liter per minute (without pressure) is needed. For Zone 2 or without any zone sweeping with inert gas is not required. In addition to sweeping with inert gas, in case of condensing media, you can connect a gas ballast in order to avoid condensation.

The ATEX Directive 2014/34/EU compliant vacuum pump offered by BINDER is designed for a gas inlet temperature of 40 °C / 104 °F max. Do NOT exceed this temperature. If the gas inlet temperature is too high and then becomes even warmer by compression in the pump, the resulting temperature (of the gas-solvent mixture inside the pump) could exceed the solvent's temperature class and auto-ignition temperature.

| | |
|---|---|
|  |  DANGER |
| <p>Fire and explosion hazard due to exceeding the solvent's auto-ignition temperature by exceeding the gas inlet temperature.</p> <p>Damage to the vacuum pump. Serious injury or death from burns and / or explosion pressure.</p> <ul style="list-style-type: none"> ➤ Do NOT exceed the set-point temperature 40 °C / 104 °F. ➤ With a set-point temperature above 40 °C / 104 °F, take appropriate measures to cool down the sucked-in gas before its entry to the vacuum pump. | |

The maximum permissible ambient temperature of the vacuum pumps supplied by BINDER is 40 °C / 104 °F.

6.5.3 Installation of the vacuum pump VP4 in the pump module (option)

| | |
|---|--|
|  | <p>Avoid the solvent accumulation in the pump module as this would cause the pump module to become an occasionally or continuously / for long periods / frequently potentially explosive area (Zone 0 or 1). The VDL vacuum drying oven located on top of the module is constructed in device category 3 in regards to its surroundings.</p> |
|---|--|



Installation of the supplied vacuum pump

- The vacuum drying oven is mounted onto the pump module as described in the mounting instructions Art. No. 7001-0401.
- The suction line to the pump module is installed as described in the mounting instructions Art. No. 7001-0401. Connect the vacuum connection (6) (small flange DN 16) on the back of the chamber to a vacuum suction lead. When using a vacuum tube BINDER recommends the BINDER connection kit for VP4 (chap. 6.5.5). The optional pump module has a corresponding hose outlet on its rear.
- When the pump is removed from the original packaging, place it in the pump module.
- Connect the grounding elements as described in the mounting instructions Art. no. 7001-0401.
- Connect the pre-installed suction line to the vacuum pump inlet at the suction-side small flange connection located at the top of the condensate catchpot).
- Connect a conduit that is suitable for removing the extracted vapors from the pump module, onto the pressure-side connection of the vacuum pump (hose olive on the top-back of the emission condenser).
- Guide the end of the conduit into an exhaust air system, which is explosion-proof constructed in consideration of any possible residual solvent contents. The operator must check if an explosive atmosphere may be present at the pump exit or at the exhaust waste vapor condenser. For this purpose, use a calculation of the solvent's partial pressure at the set-up coolant temperature of the exhaust waste vapor condenser and compare it to the explosion limits of the pumped solvent. The exhaust solvent concentration should be minimized by selecting the most appropriate condensation temperature for the solvent at the refrigeration plant that can be connected to the exhaust waste vapor condenser.



The pumped-out gases at the pump exit or the exhaust waste vapor condenser must be removed in a controlled manner and according to applicable security regulations. If there is any possibility that an explosive mixture could still exist, the exhaust must be removed through antistatic conduits and disposed of according to the valid regulations of explosion protection.

- Establish the electrical connection at the pump's connector box. This must be carried out according to the original user manual of the pump manufacturer and to EN 60079-0, observing the zone that has been defined by the operator for the installation site of the pump. Equipotential bonding between the pump housing and the housing of the vacuum drying oven must be assured by the connected equipment grounding conductors of both units.

Inappropriate execution of the pump connection can lead to the risk of explosion.

| | |
|--|--|
|   |  DANGER |
| | <p>Danger of ignition and explosion by inappropriate pump connection . Serious injury or death from burns and / or explosion pressure.</p> <ul style="list-style-type: none"> ➤ It is obligatory to follow the instructions of the pump manufacturer regarding correct connection and commissioning. ➤ Observe the safety advice as in chap. 1.7. |

Extracted vapors or the occasionally used inert gas can endanger health and / or have a corrosive effect on the oven and pump.

| | |
|--|---|
|  |  WARNING |
| | <p>Danger of damage to health by release of extracted vapors. Corrosion on the chamber and the pump. Damage to health.</p> <ul style="list-style-type: none"> ➤ Remove the extracted vapors and/or inert gas via a suitable conduit from the pump module into e.g., a fume extractor facility. ➤ Directly connect the conduit to the corresponding pump outlets. |

| | |
|---|--|
|  | <p>You can connect a laboratory cooling system to the emission condenser of the vacuum pump VP4.</p> |
|---|--|

| | |
|---|--|
|  | <p>To operate the chemical membrane pumps VP4 (MZ2C EX) please refer to the enclosed pump manufacturer's operating manual.</p> |
|---|--|

| | |
|---|--|
|  | <p>Confirm that the vacuum source is designed for a gas inlet temperature corresponding to the used drying temperature, or take appropriate measures to cool down the extracted vapor before its entry into the vacuum source.</p> |
|---|--|

The ATEX Directive 2014/34/EU compliant vacuum pump offered by BINDER is designed for a gas inlet temperature of 40 °C / 104 °F max. Do NOT exceed this temperature. If the gas inlet temperature is too high and then becomes even warmer by compression in the pump, the resulting temperature (of the gas-solvent mixture inside the pump) could exceed the solvent's temperature class and auto-ignition temperature .

The maximum permissible ambient temperature of the vacuum pump supplied by BINDER is 40 °C / 104 °F.

6.5.4 Note on the use of a flame arrester

A flame arrester is not mandatory for VDL applications (TRBS 2152-4:2012). A pump designed for Zone 1 is equipped with a temperature sensor on the bearing which, in the event of a fault, causes the pump to shut down immediately.

In general: In case of a risk of ignition before or after the vacuum pump, the operator must provide suitable flame arresters in accordance with EN 12874. The suitability (chemical resistance, sufficient flow and safety against clogging) must be ensured before commissioning.

6.5.5 ATEX connection kit for vacuum pump VP4 (option)

Connection kit for VP4 (Art. no. 8012-0621) consists of:

- Straining ring DN10/16 (3 pc.)
- Universal centering ring DN10/16 (3 pc.)
- Transition piece, adapter DN 16-10/8 (2 pc.)
- Vacuum hose 10/8, 2 m / 78.7 in
- Union nut M14 (2 pc.)
- Elbow DN 10/10



For mounting the VDL connection kit for VP4, please refer to the mounting instructions Art. no. 7001-0152 supplied with the connection kit.

6.6 Connecting inert gas supply

When operating the VDL vacuum drying oven with inert gas correctly follow the technical ventilation measures according to the local and national regulations relevant for your country (for Germany: DGUV guidelines 213-850 on safe working in laboratories, issued by the employers' liability insurance association).

When operating with inert gas, the chamber is supplied with an oxygen displacing gas, e.g., N₂. Inert gases in high concentrations are hazardous to health. They are colorless and almost odorless and therefore practically imperceptible. Inhalation of inert gases can cause drowsiness up to respiratory arrest. When the O₂ content of the air decreases below 18%, there is risk of death from lack of oxygen. Any gas that might escape has to be led out via good room ventilation or a suitable exhaust system.



DANGER

**Risk of suffocation by inert gas in a high concentration.
Death by suffocation.**

- ⊘ Do NOT set up chambers in non-ventilated recesses.
- Ensure that technical ventilation measures are activated.
- Respect the relevant regulations for handling inert gases.
- When decommissioning the vacuum drying oven, turn off the inert gas supply.

Connect the inert gas supply to the inert gas connection (adapter with hose olive diameter 8 mm / 0.31 in) via a pressure reducer. Screw the enclosed adapter with hose olive on the thread (4) at the chamber rear.



The max. inert gas overpressure after flooding should not exceed 3 mbar.

When applying a higher pressure (approx. 5 mbar), the safety valve (spring-mounted safety glass panel) opens.

| | |
|---|---|
|  | NOTICE |
| | <p>Danger of leakage due to excess inert gas overpressure. Leakage; possible disruption of the drying process. ∅ DO NOT exceed the max. inert gas overpressure of 3 mbar.</p> |

Note regarding powdered load: Set the pressure reducer to a pressure slightly above ambient pressure. Ensure that the pressure reducer will certainly open. Do not alter this setting in order to avoid perturbation inside the oven and release of big quantities of inert gas after flooding the VDL.

When the chamber is disconnected from power supply, all solenoid valves are closed. In this condition, no inert gas can enter the vacuum drying oven and escape into the ambient air, as long as the inert gas connection with the VDL is in place.

6.7 Mounting the tilt protection holders

For chambers placed on the optional pump module it is recommended to install the supplied tilt protection.

Scope of delivery of tilt protection kit (Art.no. 8009-0870):

- 2 screws
- 2 tilt protection holders

Preparing the tilt protection holders

- Depending on the desired wall distance, you can bend the tilt protection holders accordingly.

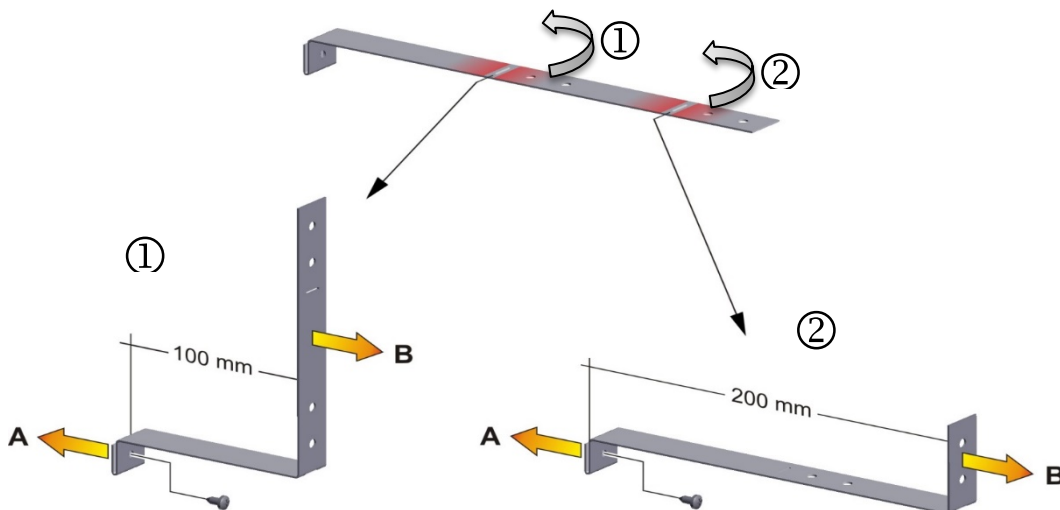

Figure 17: Variable length of the tilt protection holder depending on the bend

Installation on the chamber

- Plug the two tilt protection holders each with the tab into the mounting holes and push them upward over the rear panel. The screw holes in the rear wall and in the tilt protection holders must align.
- Fix the tilt protection holders each with one of the supplied screws on the chamber rear wall.

Wall mounting

- Then fix both tilt protection holders on the wall, each with 2 screws ∅ 6 mm suitable for the wall (B)

6.8 Achieving equipotential bonding / Grounding concept

For systems in potentially explosive areas, equipotential bonding acc. to IEC 60079-14 is required. All electrically conductive parts must be connected to the equipotential bonding system. Connections to the equipotential bonding system must be secured against automatic loosening.

Grounding, i.e. achieving equipotential bonding is required as solvent vapors may be present during loading and / or unloading. Also, when removing the filled condensate catchpot from the pump, solvents may accidentally be spilled. Therefore, the accessible surface of the installation and loading area must be conductive, there must be technical ventilation, and all equipment (VDL / pump module / vacuum pump) must be connected to the conductive surface or to each other according to the grounding concept. The personal protective equipment (PPE) of the operating personnel must be implemented ESD protected.

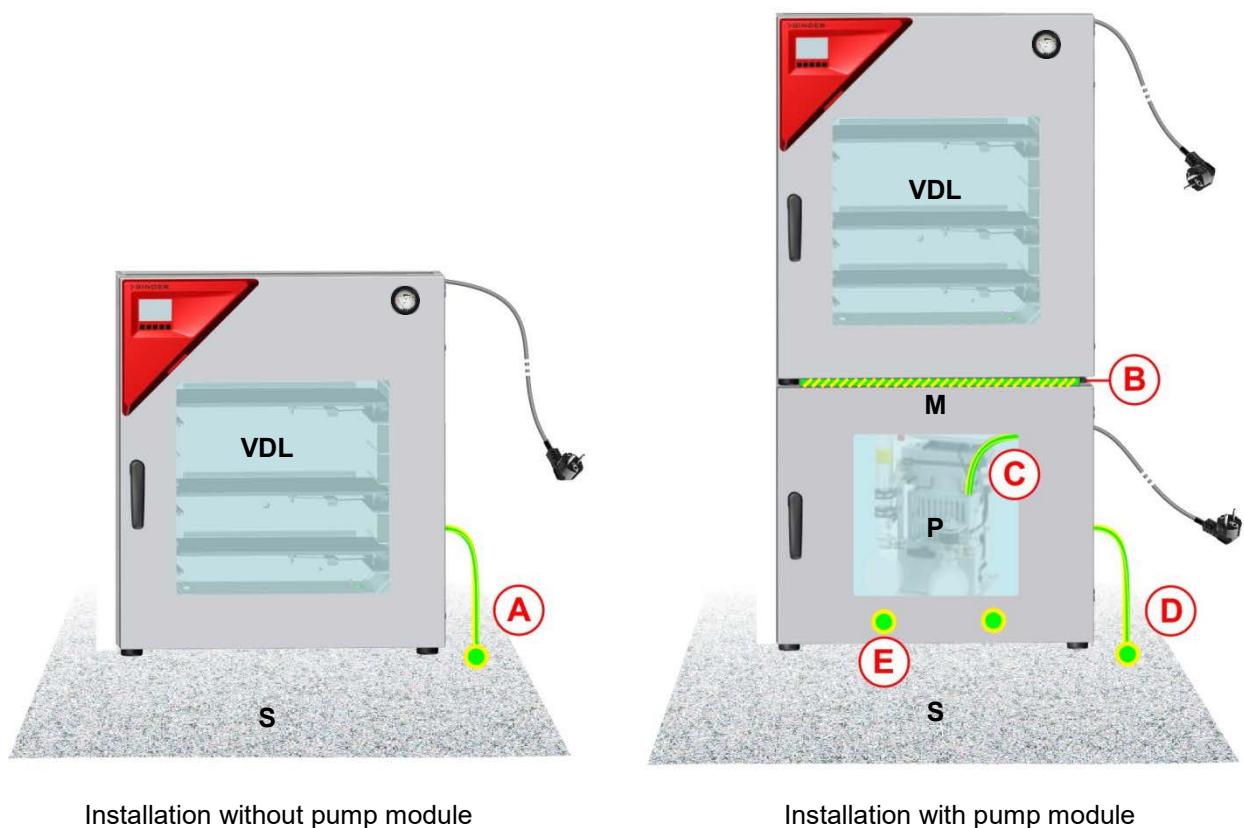

Figure 18: Possibilities of grounding (schematic representation)

- VDL** Vacuum drying oven
- M** Pump module
- S** Walkable installation and operating surface with conductive surface
- P** Vacuum pump
- A** Equipotential bonding between the VDL and the conductive surface of the installation and loading area via grounding cable
- B** Equipotential bonding between the VDL and the pump module via connecting plate
- C** Equipotential bonding between the vacuum pump and the pump module via grounding cable
- D** Equipotential bonding between the pump module and the conductive surface of the installation and loading area via grounding cable
- E** Equipotential bonding between the condensate collecting tray and the pump module via grounding cable

Achieving equipotential bonding on the VDL

Equipotential bonding must always be made via external grounding connections, so that no potential can be introduced in the event of a short circuit. **Following the installation of the VDL and having implemented all the measures described to achieve equipotential bonding, we recommend performing a protective conductor measurement before commissioning.**

| | |
|---|--|
|  | <p>The VDL provides a threaded bushing for grounding on the bottom left of the rear panel. In state of delivery the screw together with the washer and spring washer is screwed on the threaded bushing. Unscrew the screw.</p> |
|  | <p>Threaded bushing after unscrewing</p> |
|  | <p>Washer, spring washer, screw</p> |
|  | <p>Put the washer, the ring cable lug of the grounding cable and the spring washer in this order onto the screw. OR Put the spring washer, the ring cable lug of the grounding cable, and the washer directly onto the housing (recommended because this creates minimum resistance)</p> |
|  | <p>Screw on the screw into threaded bushing. Connected grounding cable</p> |

Figure 19: Mounting the grounding cable on the VDL rear panel



Figure 20: Grounding cable for the equipotential bonding between the condensate collecting tray and the pump module via



How to achieve equipotential bonding when installing the VDL with a pump module is described in detail in the mounting instructions for the pump module (Art. No. 7001-0401) supplied with the pump module.



DANGER

Explosion hazard by electric sparking due to missing or improperly implemented equipotential bonding.

Serious injury or death from burns and / or explosion pressure.



- Connect all elements in the installation and loading area (VDL / pump module / pump) with the conductive surface and/or with each other. Proceed according to the grounding plan in chap. 6.8.
- For installation of the pump module proceed acc. to the mounting instructions of the pump module (Art. no. 7001-0401).
- Make sure that the personal protective equipment (PPE) of the operating personnel is implemented ESD protected. This applies also to gloves.
- Before commissioning, measure the equipotential bonding after first setting up the VDL and implementing all described measures for establishing the equipotential bonding.
- Provide cyclic measurements of the equipotential bonding.
- Always wear ESD-protected safety clothing when operating the chamber.

6.9 Electrical connection

The chambers are supplied ready for connection. They come with a fixed power connection cable of at least 2000 mm / 78.74 in in length and a shockproof plug.

| Model | Power plug of the power cable | Nominal voltage +/- 10% at the indicated power frequency | Current type | Chamber fuse |
|------------|-------------------------------|--|--------------|--------------|
| VDL 23 | Grounded plug | 200-230V at 50 Hz 200-230V at 60 Hz | 1N~ | 2 x 6,3 A |
| VDL 56 | Grounded plug | 200-230V at 50 Hz 200-230V at 60 Hz | 1N~ | 2 x 8 A |
| VDL 115 | Grounded plug | 200-230V at 50 Hz 200-230V at 60 Hz | 1N~ | 2 x 10 A |
| VDL 23-UL | NEMA 5-15P | 100-120 V at 60 Hz | 1N~ | 10 A |
| VDL 56-UL | NEMA 5-20P | 100-120 V at 60 Hz | 1N~ | 2 x 16 A |
| VDL 115-UL | NEMA 5-20P | 100-120 V at 60 Hz | 1N~ | 2 x 20 A |



- The domestic socket must also provide a protective conductor. Make sure that the connection of the protective conductor of the domestic installations to the chamber's protective conductor meets the latest technology. The protective conductors of the socket and plug must be compatible!

| | |
|---|---|
|  |  DANGER |
| | <p>Electrical hazard due to lack of a protective conductor. Deadly electric shock.</p> <ul style="list-style-type: none"> ➤ Make sure that the power plug and power socket match and that the protective electrical conductors of the chamber and domestic installation are securely connected. |

- Only use original connection cables from BINDER according to the above specification.
- Prior to connection and start-up, check the power supply voltage. Compare the values to the specified data located on the chamber's type plate (left chamber side, bottom right-hand, see chap. 1.6).

| | |
|---|---|
|  | NOTICE |
| | <p>Danger of incorrect power supply voltage due to improper connection. Damage to the equipment.</p> <ul style="list-style-type: none"> ➤ Check the power supply voltage before connection and start-up. ➤ Compare the power supply voltage with the data indicated on the type plate. |

- When connecting, please observe the regulations specified by the local electricity supply company as well as the local or national electrical regulations (VDE directives for Germany).
- Observe a sufficient current protection according to the number of devices that you want to operate. We recommend the use of a residual current circuit breaker.



| | |
|---|---|
|  |  DANGER |
| | <p>Electrical hazard due to shock after damage to the device due to pulling on the electrical connection cable during transport. Damage to the equipment. Deadly electric shock.</p> <ul style="list-style-type: none"> ➤ After transport, check the electrical power cable at the installation site to make sure that it is connected correctly and securely. ⊘ Do NOT operate the chamber if the power cable is damaged. |

- Pollution degree (acc. to IEC 61010-1): 2
- Over-voltage category (acc. to IEC 61010-1): II

See also electrical data (chap. 28.3).

To completely separate the chamber from the power supply, you must disconnect the power plug. Install the chamber in a way that the power plug is easily accessible and can be easily pulled in case of danger. A customer's emergency stop switch or a comparable power disconnecter can also be used.

The chamber plug (power plug) is unprotected because it must be disconnected in case of an emergency to completely separate the chamber from the power supply. Therefore, the electrical connection must be established outside a zone.

| | |
|---|---|
|  |  DANGER |
| <p>Explosion hazard due to sparking when disconnecting an electrical connection. Serious injury or death from burns and / or explosion pressure.</p> <ul style="list-style-type: none"> ➤ Make sure that the electrical connection is located outside a zone. ➤ Connect the plug outside the installation area of the VDL and the pump. Take into account the information on zone classification (chap. 3.5.2) | |

7. Explosion safety tests before commissioning

This chapter provides instructions for the user to ensure the safety of the system and to meet applicable regulations. Proper operation is only ensured after the test has been carried out and any necessary measures implemented.

Follow the provisions on testing explosion protection according to country-specific regulations (for Germany in particular TRBS 1201 Part 1; this substantiates the requirements of the Industrial Safety Regulation (BetrSichV) 2015) within the scope of its application.

7.1 Scope of the functional test

The test represents the entirety of all work equipment relevant to explosion protection. This includes the vacuum drying oven with all safety, control, and regulation devices, related work equipment such as pumps or other vacuum systems, pump module, extraction devices, and ventilation systems, gas warning devices, inerting devices including connection elements as well as the installation area with effective devices for equipotential bonding and any other building components that may be relevant to explosion protection (non-exhaustive list).

- Before commissioning and after changes requiring review, perform a comprehensive inspection of the system in its entirety.
- Systems must be checked in their entirety at least every 6 years.
- Tests can also be carried out by an approved monitoring body or by personnel qualified for testing. Observe relevant regulations for the qualification requirement.
- Devices, protective systems, safety, control and regulating devices according to Directive 2014/34/EU, connection devices, and interactions with other parts of the system must continue to be checked at least every three years. Tests of ventilation systems, gas warning and inerting devices must be performed at least once per year in the future.
- It may be possible to skip recurring tests, e.g. of devices, protective systems, etc., as well as ventilation systems, gas warning and inerting devices, if a **maintenance plan** is provided. The full inspection of the entire system remains unaffected.

7.2 Explosion protection plan

The explosion protection plan to be created by the operator represents the entirety of the technical and organizational measures for explosion protection determined and specified on the basis of the risk assessment. In accordance with ATEX Operational Directive 1999/92/EC, these measures serve

- to prevent the formation of or to limit explosive atmospheres or to limit hazardous explosive mixtures
- to avoid the combustion of explosive atmospheres
- to limit the spread of an explosion and to minimize its effects on personnel in order to ensure the health and safety of employees

The explosion protection document serves to document the results of the risk assessment in accordance with § 6 Para. 9 GefStoffV (for Germany).

The explosion protection document serves to document the results of the risk assessment in accordance with § 6 Para. 9 GefStoffV (for Germany).

7.3 Objective of testing

Determine the suitability and functionality of safety-related measures. When testing the explosion safety of the system, evaluate the explosion protection plan and compare the target state derived from it with the actual state of the system (according to available test records):

- Assess the completeness and plausibility of safety-related documents (such as the explosion protection document, installation plans, zone plans, safety-related figures)
- Determine whether the system has been set up in accordance with national regulation (GefStoffV for Germany) and is safe for use with regard to explosion protection
- Technical measures are suitable and functional for explosion protection,
- Technical organizational measures necessary for explosion protection are suitable
- The deadline for the next recurring test was correctly set in accordance with national regulations (in accordance with § 3 Para. 6 BetrSichV for Germany).

Performing tests

The tests can be divided into the verification of the documentation and a technical examination.

7.4 Testing before initial commissioning



Proceed according to country-specific regulations (for Germany in particular: TRBS 1201 Part 1; BetrSichV).

Before the initial commissioning of the Ex system, perform the explosion safety test. It serves to determine the explosion safety of the system, including the work equipment and the working environment.

The test represents a comprehensive consideration of the explosion safety of the Ex system with regard to the protection of employees and other persons in the hazard area, including all functional units relevant to explosion protection and their interactions. The test of explosion safety is based on the explosion protection plan from the employer in accordance with the specifications in the explosion protection document and its implementation in the Ex system. Equivalent test results according to other legal regulations can be considered. It is also permissible to refer to tests that have already been carried out.

7.4.1 Scope of the test

7.4.1.1 Testing the plausibility of the explosion protection plan and measures

Verification of the traceability and plausibility of the explosion protection plan given in the explosion protection document and the measures derived from this in consideration of underlying constraints.

The test does not apply to systems for which this test has already been carried out in the course of a permit or approval process.

7.4.1.2 Verifying the implementation of measures

Verification of the measures described in the explosion protection document with regard to their implementation includes a holistic examination of the technical and organizational measures in accordance with the specifications of the explosion protection document. Typical test aspects (examples):

- Suitability and functionality of technical ventilation systems, gas warning systems, inerting devices, devices, protective systems, or control or regulating devices in the sense of Directive 2014/34/EU as well as explosive devices in the sense of TRGS 725
- Suitability and implementation of the measures determined on the basis of the risk assessment
- Suitability, functionality, and installation of work equipment and related connection devices that are not devices, protective systems, or safety, control, or regulating devices in the sense of Directive 2014/34/EU, but are relevant for explosion protection
- Suitability of other work equipment, such as ladders, containers, tools, for use in hazardous areas
- Suitability and functionality of other equipment and building components related to explosion protection (e.g. lightning protection systems, conductivity of floors and linings)
- Suitability of the personal protective equipment (PPE (e.g., the electrostatic discharge capacity of work shoes or gloves)
- The existence and legibility of the labels for potentially explosive areas in which measures to avoid ignition sources are required
- The existence and suitability of the organizational measures required for explosion protection
- The implementation of measures relevant to explosion protection from official requirements
- Certificates proving the correct installation of system parts, provided that their correct installation cannot or only partially be ascertained during the technical inspection, e.g. flame-arresting fittings or limit switches

7.4.1.3 Checking the deadlines for the recurring tests

When doing so, assess whether the system can be operated safely until the next specified recurring test.

7.4.1.4 Verifying the maintenance plan

When doing so, assess whether the maintenance plan is suitable for maintaining the safety of the Ex system until the next recurring test. The maintenance plan can also be used to test the technical protective measures for explosion protection of the explosive system. It can also be part of an integrated management system.

- **Definition of responsibilities** for the maintenance plan, definition of maintenance and inspection content, e.g. when creating work plans, processing the maintenance and inspection content, e.g. in the form of work plans, the assessment of deviations from the target state, and any necessary repairs.
- Determination of maintenance and inspection measures and deadlines for devices, protective systems, safety, control and regulating devices as well as their connections and interactions, technical ventilation systems, gas warning devices and inerting devices and MSR devices for explosion protection
- Comprehensible description of the required maintenance measures and deadlines e.g. in the form of work plans, work equipment of comparable design can be summarized.
- Implementation of the maintenance plan: Implementation of maintenance and inspection in accordance with the defined maintenance plan, notification of completion of the implementation of maintenance and inspection, documentation of identified repair needs and implementation of the repairs. Necessary maintenance measures must be carried out immediately. Maintenance work must be carried out by qualified specialist personnel who have sufficient experience in the maintenance of Ex systems based on the maintenance plan. The maintenance plan and the implementation of maintenance measures must be clearly documented.

7.4.2 Tests of technical ventilation systems, gas warning devices, inerting devices, devices, protective systems or safety, control or regulating devices, and other technical devices for explosion protection

Test content that has been checked and documented as part of conformity assessment procedures do not need to be checked again. Verify the plausibility and completeness of documents.

The following points must generally be verified:

- Technical ventilation systems, gas warning devices, inerting devices with regard to their suitability, their functionality, their interconnections, their installation conditions, their proper condition, and their installation / assembly
- Devices, protective systems, or safety, control, or regulating devices within the meaning of Directive 2014/34/EU on explosion protection with regard to their proper condition, their suitability, their interconnections, their installation conditions, and their installation / assembly
- Safety, control, or regulating devices with relevance for explosion protection, which can also be located outside the potentially explosive atmospheres, to determine whether ventilation systems, gas warning devices, inerting devices ensure the proper exclusion of ignition sources and functionality.
- Calibration of the Pt 100 controller sensor and, if required, subsequent adjustment is to be made before commissioning the chamber as well as part of the annual maintenance. The procedure is described in the Service manual (customer version).
- Ex devices in the sense of TRGS 725, whether they ensure the necessary functional reliability of the measures.
- Connection elements and other technical devices (such as lightning protection, requirements for floors) with regard to their condition, their interconnections, and their installation / assembly for explosion safety (e.g. type of installation, insulation resistance of electrical cables and lines)
- Take into account the significant interactions of devices, protective systems, safety, control, or regulating devices and their connecting elements – with each other and with other system parts. This includes, for example, testing the equipotential bonding, the involvement of pipes in equipotential bonding, overvoltage protection, and lightning protection, alignment of units (e.g. pump-coupling-motor).

7.5 Inspection after changes requiring review

There is a need for a change requiring review if the explosive safety of the explosive system is affected by the change. Changes requiring review are evaluated in accordance with applicable national regulations (for Germany in particular: TRBS 1123). Checks after a change requiring review may be limited to the changes made. Verify whether the system in the potentially explosive area has been changed in accordance with this regulation and is working properly. See the requirements in Chap. 7.4.

7.6 Recurring tests for the explosive safety of the system

Objective of testing: The recurring tests serve to maintain the explosive safety of the Ex system. Among other things, the actual state of the system is compared with the target state (according to the explosion protection document and available test records).

8. Functional overview and menu structure of the controller

The available controller functions depend on the current authorization (chap.12). Unless noted otherwise, the figure in this manual show the functional range, which is available for the user with “Admin” authorization level

The MB2 chamber controller controls following parameters inside the chamber:

- Temperature in °C or °F
- Pressure in mbar

You can enter the desired set point values in fixed value operation mode directly on the display surface or via the setpoint menu. For program operation the controller offers programming week and time programs. In addition, there is a timer program available (stopwatch function).

The controller offers various notifications and alarm messages with visual and audible indication and remote alarms via e-mail, an event list (trace file) and the graphical display of the measuring values in the chart recorder view. The MB2 program controller permits programming temperature and pressure cycles, and specifying special controller functions for each program section. You can enter values or programs directly at the controller or use the APT-COM™ 4 Multi Management Software (option) specially developed by BINDER.

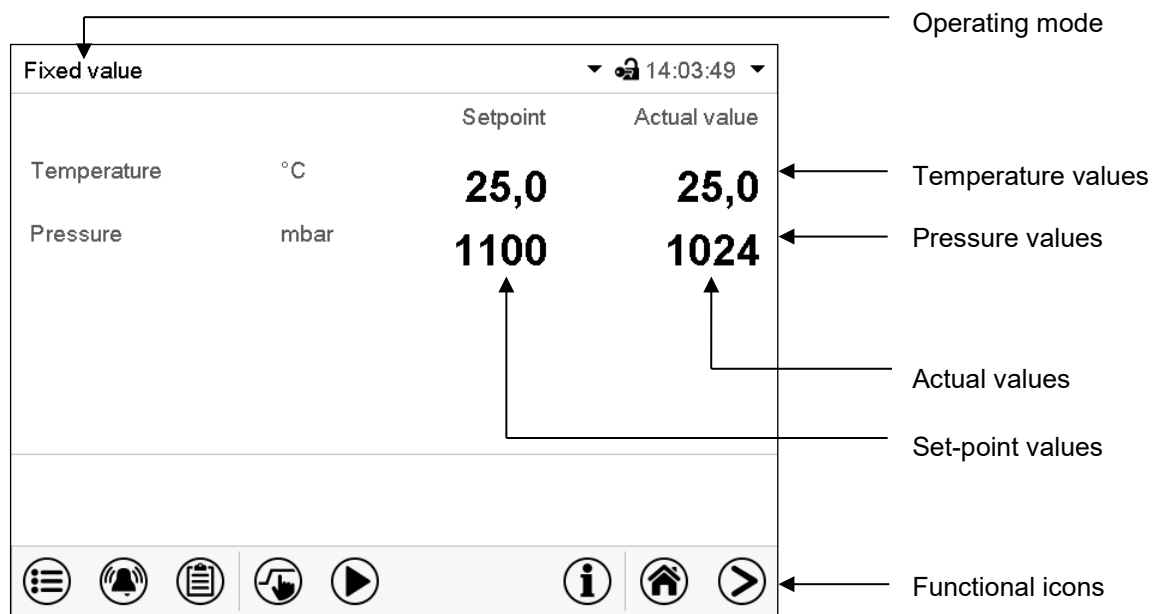

Figure 21: Normal display of the MB2 program controller (sample values)

8.1 Operating functions in normal display

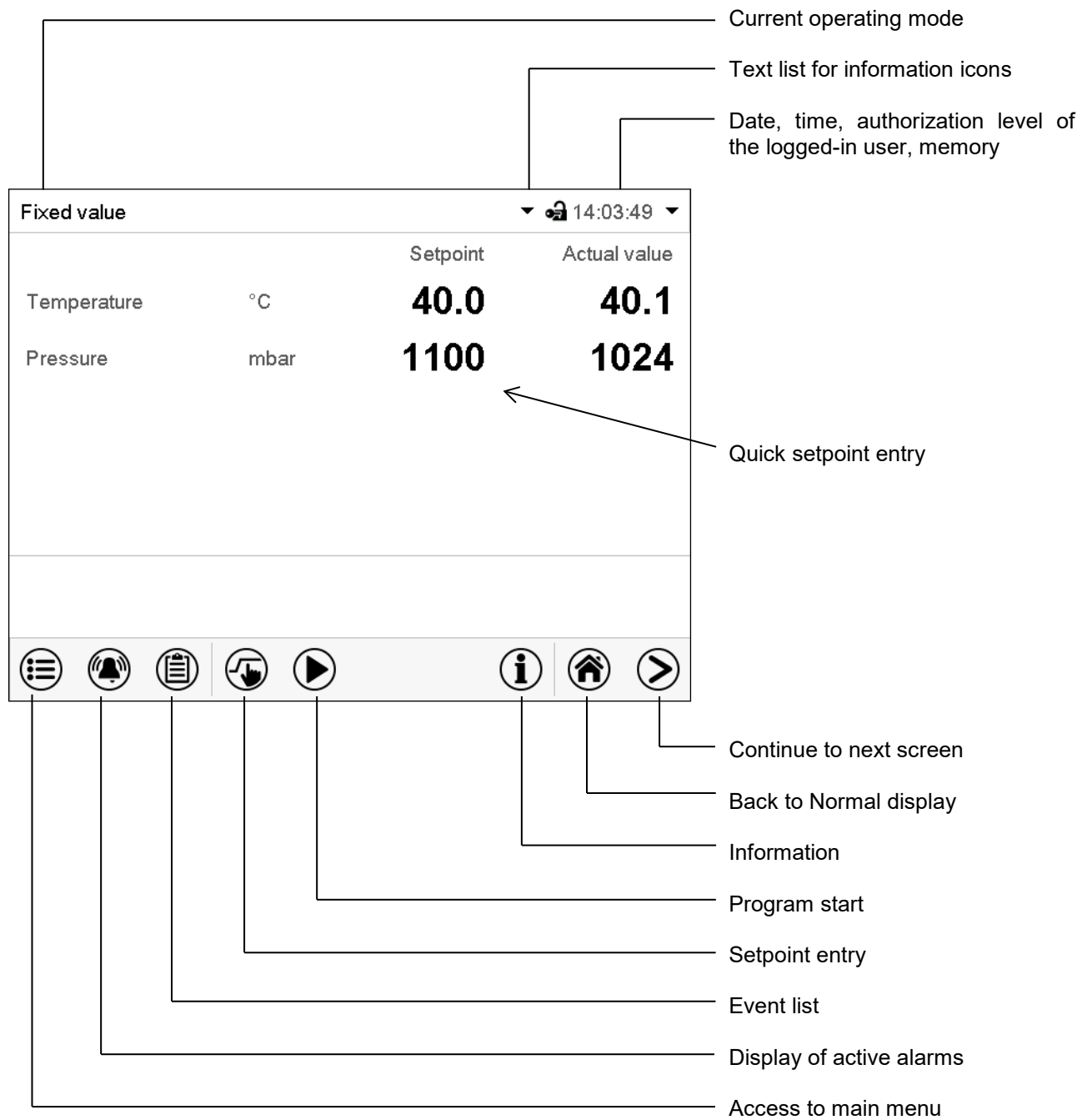

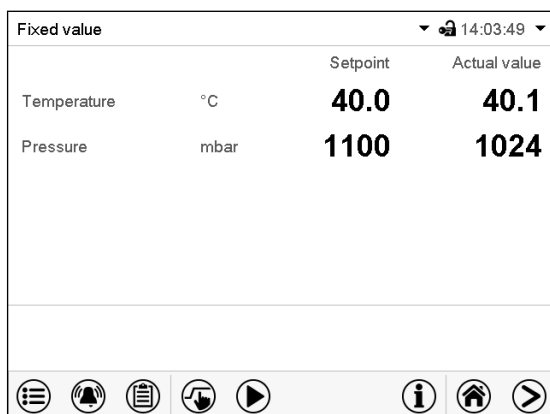

Figure 22: Operating functions of the MB2 controller in normal display (example values)

8.2 Display views: Normal display, program display, chart-recorder display

| | |
|---|--|
|  | Press the Change view icon to toggle between normal display, program display and chart-recorder display. |
|  | Press the Normal display icon to return from program display and chart recorder display back to Normal display. |



Normal display (actual values / setpoint values)

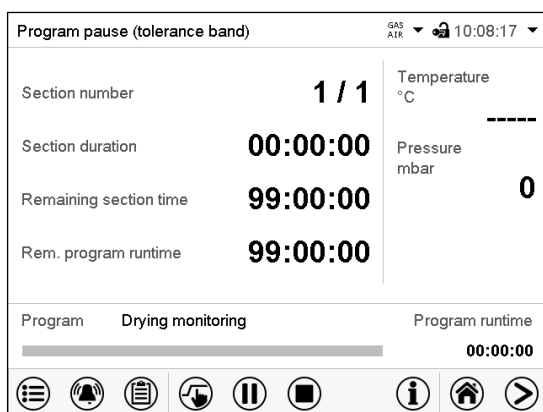

Program display (example: time program)

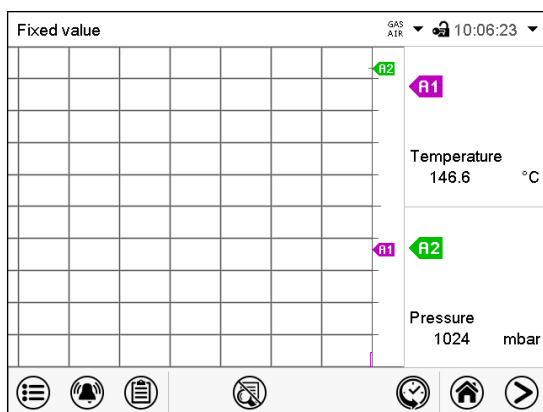



















Chart recorder display

8.3 MB2 controller icons overview









Navigation icons in Normal display

| Icon | Signification | Function |
|--|---------------------------|---|
|  | Main menu | Access from Normal display to the main menu |
|  | Alarm | Access from Normal display to the list of active alarms |
|  | Event list | Access from Normal display to the event list |
|  | Setpoint setting | Access from Normal display to the setpoint entry menu: setpoint entry for Fixed value operation, turning on/off temperature and/or pressure control, safety controller settings |
|  | Program start | Start a previously entered time or week program, continue a paused time program |
|  | Program pause | Pause a running time program |
|  | Program cancelling | Cancel a running time or week program |
|  | Information | Information on program operation, setpoints, actual values, and the safety controller |
|  | Normal display | Return from program display or chart recorder display to Normal display |
|  | Change view | Toggle between Normal display, program display, and chart recorder display |







Functional icons in individual menus

| Icon | Signification | Function |
|---|------------------------|---|
|  | Back | Return from each menu to Normal display |
|  | Update | Update the event list and alarm messages |
|  | Confirm | Take over the entries and exit the menu / continue menu sequence. |
|  | Close | Exit the menu / cancel menu sequence. Entries are not taken over. When terminating a menu sequence, an information window appears, which must be confirmed. |
|  | Reset alarm | Acknowledge the alarm and mute the buzzer. |
|  | Change keyboard | Change between uppercase and lowercase characters, digits and special characters |
|  | Edit | Edit settings of time and week programs |

Functional icons in the chart recorder display

| Icon | Signification | Function |
|---|----------------------------|---|
|  | Show legend | Show legend |
|  | Hide legend | Hide legend |
|  | History display | Pause chart recorder and change to history display. Data recording continues. |
|  | Curve selection | Go to "Curve selection" submenu in the history display |
|  | Search | Go to "Search" submenu in the history display to select the required instant |
|  | Zoom | Go to "Zoom" submenu in the history display to select the zoom factor |
|  | Show scroll buttons | Show scroll buttons in the history display to scroll to an instant |
|  | Hide scroll buttons | Hide scroll buttons in the history display to scroll to an instant |

Information icons referring to chamber conditions

| Icon | Text information | Condition |
|---|-----------------------------|---|
|  | "Standby" | Chamber is in Standby mode |
|  | "Heating active" | Chamber is heating up |
|  | "All valves are closed" | All valves are closed |
|  | "GAS/AIR" | Ventilation via regular connection "GAS/AIR" (4) |
|  | "GAS/AIR 2" | Ventilation via optional connection "GAS/AIR2" (5) Regular connection "GAS/AIR" (4) deactivated. |
|  | "Press.thresh. not reached" | Pressure threshold of 100 mbar not reached |

Information icon for data processing

| Icon | Information |
|---|--|
|  | Waiting icon: Data processing is running. Remaining time to touch the display when calibrating the touchscreen. |

8.4 MB2 controller operating modes

The MB2 program controller operates in the following operating modes:

- **Fixed value operating mode**

The controller operates as a fixed-point controller, i.e., set-points for temperature and pressure can be defined, which are then maintained until the next manual change (chap. 10.1).

- **Timer program operation**

Stopwatch function: during an entered duration the controller constantly equilibrates to the setpoints entered in Fixed value operation mode.

- **Time program operation**









An entered time program for temperature and pressure is running. The controller offers 25 program memory places with 100 program sections each. The total number of program sections of all programs is unlimited

- **Week program operation**

An entered week program for temperature and pressure is running. The controller offers 5 program memory places with 100 switching points each. The switching points can be distributed over all days of the week.







8.4.1 MB2 controller menu structure

| Fixed value | | Setpoint | Actual value |
|-------------|------|-------------|--------------|
| Temperature | °C | 40.0 | 40.1 |
| Pressure | mbar | 1100 | 1024 |

| | | | | | | | |
|---|---|---|---|---|---|---|---|
|  |  |  |  |  |  |  |  |
|---|---|---|---|---|---|---|---|

Use the **navigation icons** in the screen footer in Normal display to access the desired controller functions.



The available functions depend on the current **authorization level** "Service", "Admin" or "User" (chap. 12.1. This is selected either during login or can be available without password protection.

| | | |
|---|--|--------------------------|
|  | Main menu: program settings, further information, "Service" submenu. The "Settings" submenu allows general configuration of the controller. | chap. 8.4.2 |
|  | List of active alarms | chap. 16.2 |
|  | Access to the event list | chap. 13.5 |
|  | Setpoint entry for Fixed value operation, Standby mode, turning on/off temperature and/or pressure control , safety controller settings | chap. 10.1, 11.5, 14.2.2 |
|    | Start/ pause/ cancel an already entered, respectively a running time program or start / cancel an already entered, respectively a running week program | chap. 18.1, 18.2, 19.1 |









Unless noted otherwise, the figures show the functional range, which is available for the user with "Admin" authorization level.

8.4.2 Main menu

The main menu provides access to the general configuration of the controller as well as to program entry and the user administration. Additionally, there are support functions like a contact page or the display calibration depending on the available angle.

| | |
|---|--|
|  | Press the Main menu icon to access the main menu from Normal Display. |
|  | Press the Back icon to return from each setting menu to Normal Display. |

The main menu provides the following functions and submenus.

| | | |
|---|---|---|
| Main menu | | |
|  User | ^ | User management: login and logout, password management |
|  Device info | | Chamber information |
|  Settings | ≡ | “Settings” submenu (not visible for user with “User” authorization level) |
|  Programs | | “Programs” submenu (not visible for user with “User” authorization level) |
|  Service | | “Service” submenu |
|  Contact | | BINDER Service contact page |
|  Calibrate touchscreen | v | Calibrating the touch screen |
|  | | Back to Normal Display |

“Settings” submenu

- Settings of many general controller functions and network settings (chap. 13).
- Available only for users with “Service” and “Admin” authorization level

“Service” submenu

- Access to service data, controller reset to factory settings (chap. 8.4.4)
- Available only for users with “Service” and “Admin” authorization level. Full functional range only for BINDER Service (users with “Service” authorization level).

“Programs” submenu

- Access to the controller’s program functions (chap. 17, 18, 19)
- Available only for users with “Service” and “Admin” authorization level.

8.4.3 “Settings” submenu

The “Settings” submenu is available for users with “Service” or “Admin” authorization level. It serves to enter date and time, select the language for the controller menus and the desired temperature unit and to configure the controller’s communication functions.

Path: [Main menu > Settings](#)

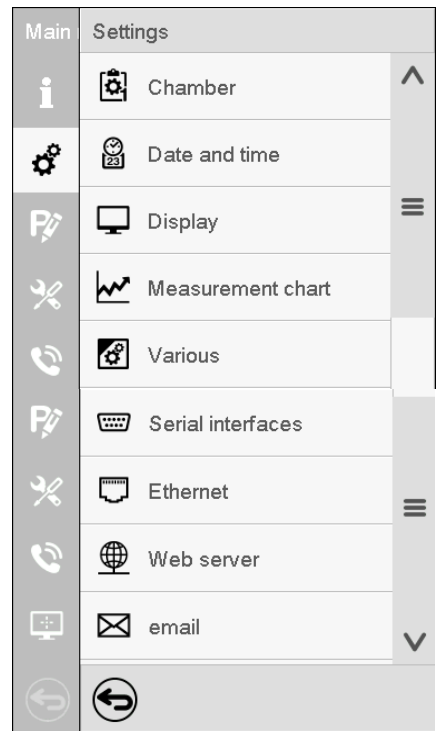
| | | | |
|--|-------------------|--|-------------|
|  | Chamber | Setting the temperature unit, menu language... | chap. 13.1, |
| | Date and time | Setting date and time | chap. 13.2 |
| | Display | Setting the display brightness, continuous operation and screen saver | chap. 13.4 |
| | Measurement chart | Settings for the measurement chart: storage interval, storage values, minimum and maximum values | chap. 22.2 |
| | Various | Setting the tolerance range and delay time for tolerance range alarm | chap. 15 |
| | Serial interfaces | (not used) | |
| | Ethernet | Entry of the MAC address and IP address | chap. 20.1 |
| | Web server | Password protection for web server access | chap. 20.2 |
| | email | Configuration of the e-mail server, assignment of e-mail addresses | chap. 20.3 |
| | | Back to main menu | |

8.4.4 “Service” submenu

The “Service” submenu is available for users with “Service” or “Admin” authorization level. When logged-in with “Admin” authorization level the user will find information to tell the BINDER Service in service case.

Path: [Main menu > Service](#)

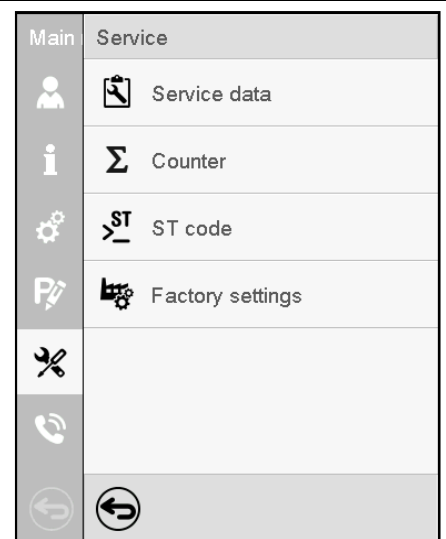
| | | | |
|---|------------------|--|------------|
|  | Service data | Serial number of the chamber, setup version of the controller software | chap. 13.8 |
| | Counter | No function | |
| | ST code | Information for BINDER Service | |
| | Factory settings | Reset to factory settings | |
| | | | |
| | | Back to main menu | |

(view with “Admin” authorization level)

8.5 Principle of controller entries

In the selection and entry menus there are icons displayed in the footers which you can use to take over the entry or cancel it.

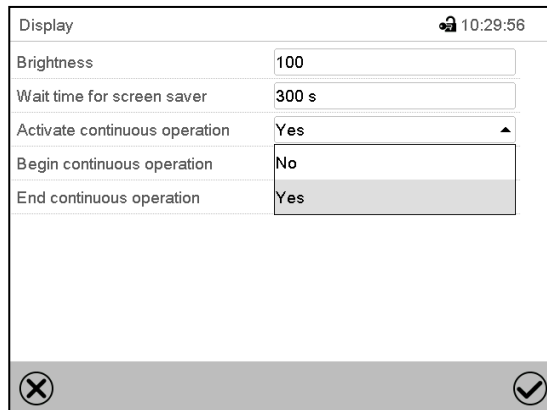

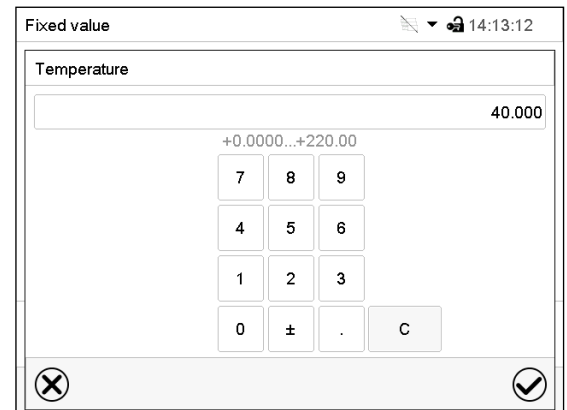

Selection menu (example)



Entry menu (example)

After completing the settings there are the following possibilities:

| | |
|---|--|
|  | Press the Confirm icon to take over the entries and exit the menu or continue the menu sequence. |
|  | Press the Close icon to exit the menu or cancel the menu sequence without taking over the entries. When terminating a menu sequence, an information window appears, which must be confirmed. |

8.6 Performance during and after power failures

During a power failure, all controller functions are shut down.

If there is a vacuum and ventilation is required during the duration of the power failure, this is possible via the emergency ventilation (chap. 9.9.3).

After the power returns, all functions return to the same status the chamber had before power failure.

| | |
|---|--|
|  | All settings and set point values remain in the memory during power failure. |
|---|--|

- If the Standby mode had been activated prior to the power failure, the chamber remains off after the power returns. To operate it you must sign in with a higher authorization level and deactivate the standby mode.
- If the Standby mode had been deactivated prior to the power failure, operation continues after the power returns with previously entered parameters. If the pressure reaches or falls below the required pressure threshold of 100 mbar, the heater turns on depending on the setpoint.

After the power returns, the controller continues to function in the original **operating mode** it was in previously before the power failure occurred:

- Performance after power failure in **Fixed value operation mode**
All functions return to the same status the chamber had before power failure. The set-points are immediately resumed.
- Performance after power failure during **Timer operation**
The set-points which had been active at the moment of program start are resumed. Program run continues.

- Performance after power failure during **Time program operation**
The program is resumed at the point where the interruption occurred with the latest set-points reached during the program run.
- Performance after power failure during **Week program operation**
The week program continues with the values corresponding to the current time.

Power failure and power return are noted in the **Event list** (chap. 13.5).

If during power failure an **alarm** has occurred (e.g., tolerance range, safety controller), confirm the alarm. See chap. 16.3.

9. Start up and performing the drying process

With regard to operating the vacuum drying oven VDL and to the installation location, please observe the relevant local and national regulations (for Germany in particular: DGUV guidelines 213-850 on safe working in laboratories, issued by the employers' liability insurance association; Industrial Safety Regulation (BetrSichV); Ordinance on Hazardous Substances (GefStoffV); Technical Regulations on Industrial Safety and Health (TRBS 1201 Part 1).

Note: Warming chambers may release odors in the first few days after commissioning. This is not a quality defect. To reduce odors quickly we recommend heating up the chamber to its nominal temperature for one day and in a well-ventilated location.



Do not start up the chamber without technical ventilation (chap. 5.2.2).

9.1 Requirements for safe commissioning

Prior to turning on the chamber, the following points must certainly be met:

- Installation of the chamber (chap. 6) performed in compliance with the installation guidelines and ambient conditions (chap. 5)
- Compressed air connection established for sweeping the electrical installation room, the preheating chamber (heating area between inner and outer chamber) and the controller housing. The compressed air supply line provided by the operator must be equipped with active monitoring of the defined inlet pressure (2 bar).
- Vacuum supply connected (chap. 6.5)
- If required: Inert gas connection established (chap. 6.6)
- Equipotential bonding established (chap. 6.8)
- Observing all safety instructions
- Upon initial commissioning: Test before initial commissioning performed and passed (Chap. 7.4)
- Upon recommissioning after maintenance / repairs / changes requiring review: Test performed and passed (Chap. 7.5)
- Technical ventilation activated
- Power connection established (chap. 6.9).

9.2 Overview of the drying process

Required measures for operation with solvent-containing substances, which may be able to form an explosive mixture with air:

| Starting situation | |
|---|--------------------------|
| <ul style="list-style-type: none"> The vacuum drying oven and additional equipment have been set up and installed in accordance with the instructions in this manual, the instructions of the operator and the relevant regulations. Equipotential bonding according to the grounding concept is ensured | <input type="checkbox"/> |
| <ul style="list-style-type: none"> The auto-ignition temperature of the solvent has been determined from its safety specifications In the case of solvent mixtures, use the lowest auto-ignition temperature. | <input type="checkbox"/> |
| <ul style="list-style-type: none"> All users have been trained and are familiar with the safety plan and the required measures. | <input type="checkbox"/> |
| <ul style="list-style-type: none"> The vacuum source is connected and ready for operation | <input type="checkbox"/> |
| <ul style="list-style-type: none"> The technical ventilation is activated. | <input type="checkbox"/> |
| <ul style="list-style-type: none"> The compressed air supply is connected and ready for operation. The monitoring of the defined inlet pressure (2 bar) is active. | <input type="checkbox"/> |
| Sweeping the area for electrical equipment, the preheating chamber, and controller housing (triangular instrument box) | |
| <ul style="list-style-type: none"> Make sure that the inner chamber temperature is below 60 °C. Turn the pressure regulator on the chamber rear until the clamping ring touches the lower stop (turn clockwise). | <input type="checkbox"/> |
| <ul style="list-style-type: none"> Open the sweeping plug on the chamber rear and the USB cover on the controller housing. | <input type="checkbox"/> |
| <ul style="list-style-type: none"> Sweep the electrical installation room, the preheating chamber and the controller housing with compressed air for the specified duration (chap. 9.3.2) at maximum overpressure | <input type="checkbox"/> |
| <ul style="list-style-type: none"> Close the sweeping plug on the chamber rear and the USB cover on the controller housing | <input type="checkbox"/> |
| <ul style="list-style-type: none"> Now the pressure regulator can be turned back (counter-clockwise rotation) until the clamping ring touches the upper stop. (only tighten to the stop by hand) Check on the manometer that an overpressure of at least 25 Pa (recommendation: >40 Pa) has been reached | <input type="checkbox"/> |
| Loading and starting the drying process | |
| <ul style="list-style-type: none"> Make sure that the technical ventilation is activated | <input type="checkbox"/> |
| <ul style="list-style-type: none"> Make sure that equipotential bonding has been established according to the grounding concept | <input type="checkbox"/> |
| <ul style="list-style-type: none"> Make sure that the sweeping times of the electrical installation room, preheating chamber, and controller housing (triangular instrument box) have been observed | <input type="checkbox"/> |
| <ul style="list-style-type: none"> Make sure that the compressed air supply for sweeping the electrical installation area, preheating chamber, and controller housing is still open. Check the excess pressure of at least 25 Pa on the manometer (recommendation: >40 Pa). | <input type="checkbox"/> |
| <ul style="list-style-type: none"> In case of Standby mode turn on the vacuum drying oven on the controller | <input type="checkbox"/> |
| <ul style="list-style-type: none"> Set the desired temperature setpoint on the controller. | <input type="checkbox"/> |
| <ul style="list-style-type: none"> Set the safety controller to a suitable value. Recommended setting: safety controller mode: Limit, safety controller value approx. 5 °C above the temperature set-point | <input type="checkbox"/> |

| | |
|---|--------------------------|
| <ul style="list-style-type: none"> • Make sure that the user's equipment is ESD protected. • Place the material to be dried in the chamber. | <input type="checkbox"/> |
| <ul style="list-style-type: none"> • Set the pressure set-point on the controller. Heating will start only when a vacuum corresponding to the pressure threshold of 100 mbar) is reached. | <input type="checkbox"/> |
| The drying process is running. | |
| After completing the drying process or when cancelling the drying process | |
| When the pressure drops to the pressure set-point, the drying process is finished. If the drying monitoring (chap. 11.6) is activated, a corresponding message is displayed. | |
| <ul style="list-style-type: none"> • Make sure that the technical ventilation is activated • Make sure that equipotential bonding has been established according to the grounding concept | <input type="checkbox"/> |
| <ul style="list-style-type: none"> • For ventilation, set the pressure set-point to atmospheric pressure | <input type="checkbox"/> |
| <ul style="list-style-type: none"> • Switch the vacuum drying oven on the controller to standby mode (not completely de-energized) | <input type="checkbox"/> |
| <ul style="list-style-type: none"> • Make sure that the user's equipment is ESD protected. • Remove the drying material | <input type="checkbox"/> |
| <ul style="list-style-type: none"> • Continue sweeping the electrical installation area, preheating chamber and controller housing with an overpressure of at least 25 Pa (recommendation: >40 Pa) for at least 10 minutes (recommended). Check the excess pressure on the manometer. Only then shut off the compressed air supply. | <input type="checkbox"/> |
| For emptying the pump | |
| <ul style="list-style-type: none"> • Make sure that the pump is turned off. | <input type="checkbox"/> |
| <ul style="list-style-type: none"> • Make sure that the technical ventilation is activated • Make sure that equipotential bonding has been established according to the grounding concept | <input type="checkbox"/> |
| <ul style="list-style-type: none"> • Make sure that the user's equipment is ESD protected. • Remove the full condensate catchpot of the pump | <input type="checkbox"/> |
| Before starting a new drying process | |
| <p>In case of a new solvent with a different auto-ignition temperature:</p> <ul style="list-style-type: none"> • Determine the auto-ignition temperature of the solvent from its safety specifications. In the case of solvent mixtures, use the lowest auto-ignition temperature | <input type="checkbox"/> |
| <ul style="list-style-type: none"> • Make sure that the technical ventilation is activated • Make sure that equipotential bonding has been established according to the grounding concept | <input type="checkbox"/> |
| <ul style="list-style-type: none"> • Make sure that the inner chamber temperature is below 60 °C. • Sweep the area for electrical equipment, preheating chamber and the controller housing with compressed air at maximum overpressure for a defined time (chap. 9.3.2). | <input type="checkbox"/> |
| <ul style="list-style-type: none"> • Turn on the chamber and check the settings (drying temperature, pressure set-point and safety controller setting) | <input type="checkbox"/> |
| <ul style="list-style-type: none"> • Now you can load the chamber and start the new drying process. Follow all safety measures | <input type="checkbox"/> |

9.3 Sweeping the area for electrical equipment, the preheating chamber, and the controller housing (triangular instrument box) with compressed air



Before starting sweeping with compressed air, the inner chamber temperature must be below 60 °C.

To sweep the area for electrical equipment, the preheating chamber, and the controller housing, activate the customer's compressed air supply.



The compressed air supply line provided by the operator must be equipped with active monitoring of the defined inlet pressure (2 bar), which clearly indicates a drop and increase in the inlet pressure outside the permissible tolerance of ± 0.2 bar.

9.3.1 Setting the pressure regulator for sweeping with compressed air

After opening the pressure regulator on the chamber rear (turn clockwise), the area for electrical equipment of the oven, the preheating chamber (the heater area between the inner and outer chamber) and the controller housing will be swept. Compressed air is used and then released into the surrounding atmosphere independent of the oven's operating state.

Compressed air sweeping must be in operation for a defined time (chap. 9.3.2) before turning on the chamber. It remains in operation during the entire use of the chamber (loading, drying, removal of the material to be dried), with an overpressure of at least 25 Pa (recommendation: >40 Pa). This operating point is defined on the pressure regulator when the clamping ring touches the upper stop. After terminating the drying procedure and turning off the chamber it is recommended to continue sweeping for approx. 10 minutes.

On the chamber front there is an analog pressure display (manometer) to show the existing overpressure.

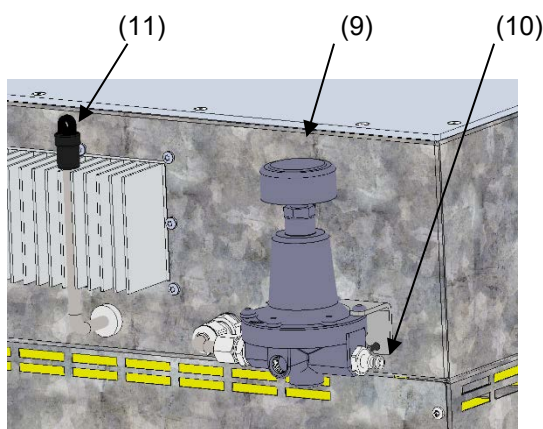

Figure 23: Pressure regulator and sweeping plug for compressed air sweeping on the chamber rear





Figure 24: analog pressure display (manometer) for compressed air sweeping on the chamber front

- (9) Pressure regulator for compressed air sweeping
- (10) Connection for compressed air sweeping / overpressure
- (11) Outlet with sweeping plug for compressed air sweeping before start-up

9.3.2 Sweeping before starting up / restarting the chamber

Before turning on the VDL it is mandatory to sweep the area for electrical equipment, the preheating chamber and controller housing (triangular instrument panel) with compressed air at maximum overpressure for a defined time.

Before starting sweeping with compressed air, the inner chamber temperature must be below 60 °C.

| | |
|---|--|
|  |  CAUTION |
| <p>Danger of burning by hot exhaust air and risk of leaks due to damage to the exhaust air hose if the inner chamber temperature is too high.</p> <p>Burns. Damage to the chamber.</p> <ul style="list-style-type: none"> ➤ Before starting sweeping with compressed air, make sure that the inner chamber temperature is below 60 °C. ➤ As long as the sweeping plug is open, the inner chamber temperature must be below 60 °C. | |

Sweeping the electrical installation room, preheating chamber and controller housing (instrument triangle)

- Turn the pressure regulator until the clamping ring touches the lower stop (turn clockwise). This gives the maximum overpressure.
- Open the sweeping plug on the chamber rear next to the pressure regulator
- Check that compressed air flows out of the sweeping plug (caution, the outflowing air may be hot)
- Open the USB cover on the controller housing (instrument triangle)
- Check if compressed air is coming out of the USB cover (caution, the outflowing air may be hot)
- Sweep with maximum overpressure for at least the following duration
 - VDL 23: 20 minutes
 - VDL 56: 30 minutes
 - VDL 115: 40 minutes
- Then close the sweeping plug on the chamber rear.
- Also connect the USB cover on the controller housing (instrument triangle)
- Now the pressure regulator can be turned back (counter-clockwise rotation) until the clamping ring touches the upper stop. (Only tighten to the stop by hand)
- Check that there is an overpressure of at least 25 Pa (recommendation: >40 Pa).

9.3.3 Sweeping during chamber operation

Sweeping the electrical installation room, the preheating chamber and controller housing must take place with an overpressure of at least 25 Pa (recommendation: >40 Pa) during the entire operation of the vacuum drying oven. This operating point is defined on the pressure regulator when the clamping ring touches the upper stop. Also, after termination or cancellation of the drying process continued sweeping for at least 10 minutes is recommended.

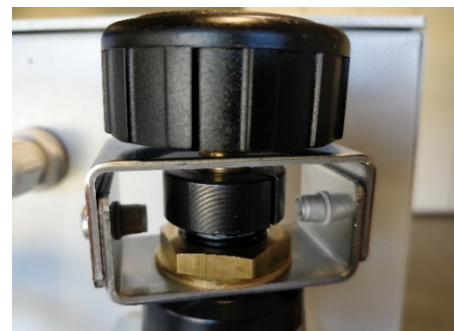





Figure 25: Pressure regulator with defined setting at the upper stop

| | |
|--|---|
|  |  DANGER |
| <p>Explosion hazard by solvent-containing air penetrating and concentration in the electrical area of the chamber and at the heater.</p> <p>Serious injury or death from burns and / or explosion pressure.</p> <ul style="list-style-type: none"> ➤ Make sure that sweeping the area for electrical equipment, preheating chamber, and controller housing with compressed air for the defined time (chap. 9.3.2) at maximum overpressure has been done before turning on the chamber. ➤ Make sure that sweeping the area for electrical equipment, preheating chamber, and controller housing with compressed air with an overpressure of at least 25 Pa (recommendation: >40 Pa) takes place during the entire operation. ➤ Ensure that the compressed air supply line provided by the operator is equipped with active monitoring of the defined inlet pressure which clearly indicates a drop and increase in the inlet pressure outside the permissible tolerance of ± 0.2 bar | |

Proceeding

- The sweeping plug on the chamber rear and the USB cover on the controller housing must be closed
- Adjust the pressure regulator until the clamping ring touches the upper stop. (Only tighten to the stop by hand)
- Check this display during operation of the chamber. In all operating states, the value on the manometer must show an overpressure of at least 25 Pa. Recommended value: >40 Pa.

| | |
|--|--|
|  | <p>Regarding use of the USB connection during chamber operation please observe the instructions given in chap. 21.1.</p> |
|--|--|

9.3.4 Sweeping after completion of chamber operation (recommended):

- You can stop sweeping 10 minutes after turning off the chamber: Close the pressure regulator to (turn counterclockwise).
- Then you can close the compressed air supply.
- Check on the manometer that there is no longer any overpressure.

9.4 Condition after establishing the power connection

| | |
|---|--|
|  | <p>Only trained personnel with key-authorization may work on the VDL vacuum drying oven.</p> |
|---|--|

Prior to establishing the power connection, the following points must certainly be met:

- Installation of the chamber (chap. 6) performed in compliance with the installation guidelines and ambient conditions (chap. 5)
- Vacuum supply connected (chap. 6.5)
- If required: Inert gas connection established (chap. 6.6)
- Equipotential bonding established (chap. 6.8)
- Upon initial commissioning: Test before initial commissioning performed and passed (chap. 7)
- Technical ventilation is activated
- Sweeping the area for electrical equipment, preheating chamber, and controller housing with compressed air for the defined time (chap. 9.3.2) at maximum overpressure has been done

Establish the power connection: connect the power plug (chap. 6.9). Connect the power supply only when needed, and disconnect it when the chamber is not in use for an extended period.

After establishing power supply the pilot lamp in the controller housing shows readiness for operation.

The authorization level is "User". To be able to use the entire functionality of the controller, log in with the desired authorization level.

All parameters, set-points and settings remain the same as before turning off.

- If the Standby mode had been activated prior to the power failure, the chamber remains off after the power returns. To operate it you must sign in with a higher authorization level and deactivate the standby mode.
- If the Standby mode had been deactivated prior to the power failure, operation continues after the power returns with previously entered parameters. If the pressure reaches or falls below the required pressure threshold of 100 mbar, the heater turns on depending on the setpoint

9.5 Standby mode Turning on and off the vacuum drying oven

Before turning on the chamber, the following points must surely be met:

- Equipotential bonding established (Chap. 6.8)
- Technical ventilation is activated
- Sweeping the area for electrical equipment, preheating chamber, and controller housing with compressed air for the defined time (chap. 9.3.2) at maximum overpressure has been done

Activate the chamber only as required. Switch the chamber to standby mode when it is not in use.

In standby mode no solvents may remain inside the chamber!



Before turning off the chamber (activating standby mode), completely remove all solvents from the chamber and its surroundings.



All settings and target values remain saved in standby mode.

If a program is running, it will be canceled by activating the standby mode

In Standby mode, the heating is off, and all valves are closed. Heating control and pressure control are off.

To completely separate the chamber from the power supply, you must disconnect the power plug.

For decommissioning observe the guidelines in chap. 27.2.

Required authorization: "Admin".



Press the **Setpoint setting** icon to access the "Setpoint" setting menu from Normal display.

Path: [Setpoint](#) > [Fixed value operation setpoints](#) > [Functions on/off](#)

In this menu you can activate and deactivate the Standby mode .

Activating the Standby mode (turning off the chamber):

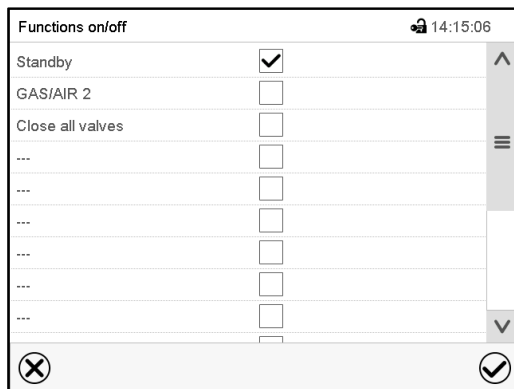

“Functions on/off” menu

Mark the checkbox of the function “Standby” to activate it and press the **Confirm** icon.

In the “Setpoints” menu press again the **Confirm** icon. The controller changes to Normal display.

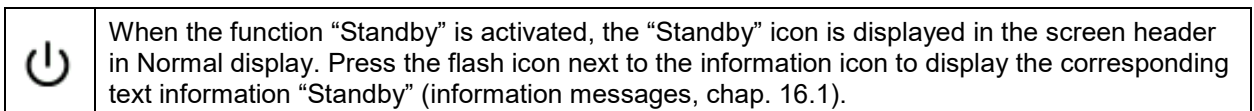

When the controller display is dark in standby mode, press on the touchscreen to activate it for 10 seconds.

Deactivating the Standby mode (turning on the chamber)

To deactivate the “Standby” function, unmark the checkbox.

9.6 Controller settings upon start up

Depending on the functions activated in the controller, various settings can be requested directly after turning on the chamber.

Then you should assign a password for the operating level (chap. 12).

The window “Language selection” enables the **language selection**, in case that it’s activated in the “Start-up” menu. Afterwards occurs a request of the **time zone** and the **temperature unit**.

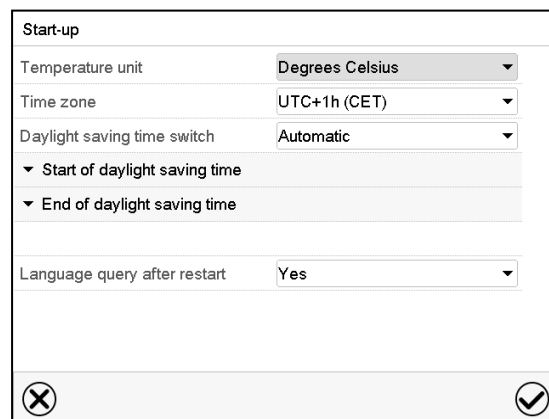
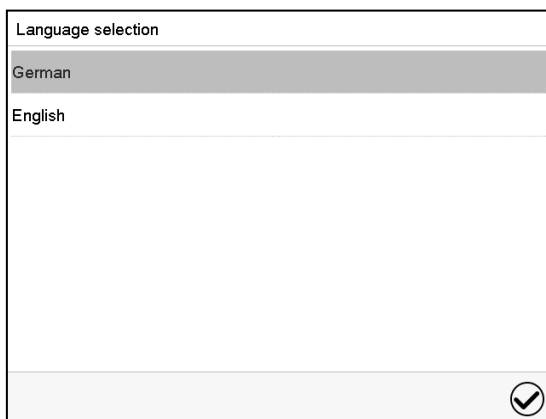

The controller will function in the **operating mode**, which was active before the last shut-down. It controls temperature and pressure in fixed value operating mode to the last entered values and in the program mode to the set points achieved beforehand.

Locked operation

Provided that the user administration has been activated by the assignment of passwords for the different authorization types, the **controller operation** is first locked after turning on the unit, recognizable by the closed lock icon in the header.

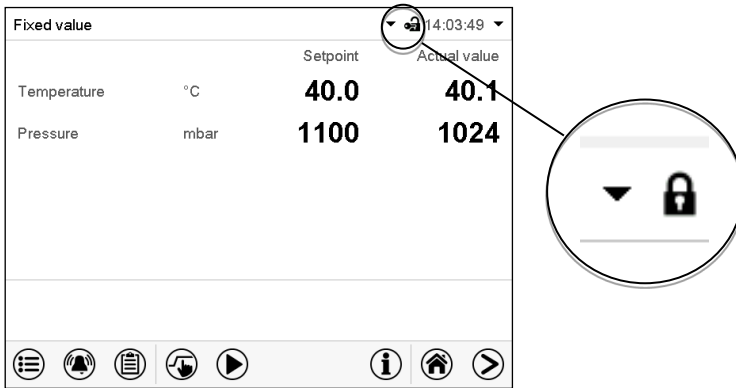

In the locked view the controller provides all display functions. No setting functions are available.

The setpoints are shaded (light grey) in normal display. Changing them by direct entry in the fixed value operating mode is not possible. The functional icons for setpoint entry and program start in the footer are without function.

After turning on the unit, user log-in is required to operate the controller (chap. 12.2).

Operation without user log-in / without password-protection

If the password function has been deactivated, after turning on the unit without user log-in there are those controller functions available, which correspond to the highest authorization level without a password protection. There is no lock icon in the header.

9.7 Loading



Without technical ventilation the chamber must not be loaded with material containing solvents.

The chamber cannot be loaded when turned off / in standby mode .

Before loading the material to be loaded, note:



When loading the chamber also in the context of intended use, an explosive mixture may form in the working space. Therefore, a safety area of at least. 1 m in front of the oven must be considered.

- Ensure equipotential bonding. The accessible installation and operating surface of the equipment must be conductive. This installation and operating surface must be connected with the vacuum drying oven according to the grounding plan (Chap. 6.8).
- The personal protective equipment (PPE) of the operating personnel must be implemented ESD protected. This applies also to gloves.
- Activate the technical ventilation (extraction):



The operator shall provide active ventilation (technical ventilation according to country-specific regulations (TRBS 2152 Part 2 for Germany) prior to commissioning of the chamber. It must include the entire installation area of the vacuum drying oven. Loading must take place under technical ventilation in the safety area in front of the oven.

- Introduce only those solvents for which the auto-ignition temperature and the maximum drying temperature (safety temperature) have been determined and setting on the safety controller has been performed.

Acc. to IEC 60079-0, only substances with an auto-ignition temperature above 200 °C / 392 °F may be introduced into the chamber. **This chamber is NOT suitable for drying substances with an auto-ignition temperature below 200 °C.**

| | |
|--|---|
|   |  DANGER |
| | <p>Explosion or implosion hazard and danger of poisoning by introduction of unsuitable loading material.</p> <p>Serious injury or death from burns and / or explosion pressure or by poisoning.</p> <ul style="list-style-type: none"> ⊘ Do NOT introduce any substance with an auto-ignition temperature below 200 °C / 392 °F into the chamber. ⊘ Do NOT introduce any substance which is combustible or explosive at working temperature into the chamber. ⊘ Do NOT introduce energy sources such as batteries or lithium-ion batteries into the chamber. ⊘ Do NOT introduce any substance, which fall under the explosives law into the chamber ⊘ Do NOT introduce any combustible dust into the chamber. ⊘ Do NOT introduce any substance which could lead to release of toxic gases into the chamber. |

If the auto-ignition temperature of a solvent contained in the drying material is exceeded during the drying process, there is an immediate risk of fire and explosion. Make sure that the auto-ignition temperature of a solvent contained will NEVER be reached.

| | |
|--|---|
|  |  DANGER |
| | <p>Fire and explosion hazard when exceeding the auto-ignition temperature of the solvent.</p> <p>Serious injury or death from burns and / or explosion pressure.</p> <ul style="list-style-type: none"> ➤ Take the auto-ignition temperature from the safety specifications of the solvent. In the case of solvent mixtures, use the lowest auto-ignition temperature. ➤ Correctly set the maximum drying temperature (safety temperature) on the temperature safety device according to the information panel "Temperature setting". ➤ Introduce measures to prevent mixing up the material to be dried. ➤ Before starting a new drying process with a different auto-ignition temperature, check the auto-ignition temperature with the safety specifications of the solvent. |

If, during loading material containing solvents falls down, it is possible that the solvent or solvent vapors will spread outside the loading area, e.g. to the side of or below the chamber. The chamber must be disconnected from the power immediately (pull out the power plug or operate e.g., a customer's emergency stop switch).

The chamber is not to be installed and operated in potentially explosive areas.

| | |
|---|---|
|  |  DANGER |
| | <p>Explosion hazard due to explosive mixtures in the vicinity of the equipment.</p> <p>Serious injury or death from burns and / or explosion pressure.</p> <ul style="list-style-type: none"> ⊘ Ensure that NO solvents or explosive solvent-air mixtures are located in the area around the chamber. ➤ Disconnect the chamber from the power immediately if there is explosive atmosphere in the area around the chamber outside the indicated loading area. |

9.8 Evacuation

Starting situation: The vacuum pump / vacuum system is connected and ready for operation.

Preparation:

- Make sure that the “Manual ventilation” plug (7) for emergency ventilation in case of a power failure, which is located on the chamber rear, is closed
- Make sure that the pressure control is activated.
- Turn on the vacuum pump. The pump shall continue running during the entire drying procedure.
- Set the desired pressure set-point on the controller (chap. 10).
- Monitor the internal pressure on the controller display



As long as there is a vacuum, never try to open the oven by force.

9.9 Breaking the vacuum (flooding)

9.9.1 Ventilation after completing the drying procedure (flooding with ambient air or inert gas)

The duration of the drying procedure can be determined via the pressure display on the controller. When the decreasing pressure reaches the set-point value, the drying process is completed. If the drying monitoring (chap. 11.6) is activated, a corresponding message is displayed.

To break the vacuum (ventilation) after completing the drying procedure, set the desired pressure set-point to atmospheric pressure (chap. 10). The ventilation valve opens, and ambient air or inert gas flow into the inner chamber.

Regularly the universal connection for inert gas / ambient air “GAS/AIR” (4) is used for ventilation.

Chambers can be equipped as an option with an additional universal connection for inert gas / ambient air “GAS/AIR2” (5), which can be used alternatively. To do this, the controller function “GAS/AIR 2” serves to close the valve of the standard connection “GAS/AIR” (4). Then the valve of the optional connection “GAS/AIR 2” (5) is used for ventilation (chap. 11.2). This allows convenient switching when both connections are used differently (e.g., for inert gas and ambient air).

Ambient air is sucked in through the universal connection for inert gas / ambient air (4) or (5). The ambient air is introduced into the lower part of the rear panel of the inner chamber and is evenly distributed in the inner chamber. This supply of ambient air by under-flooding prevents turbulence of pulverized drying material.



Following ventilation, remove the loading material.

If no further drying process is to be carried out, switch the chamber to standby mode on the controller or pull the mains plug to switch off the chamber completely.

9.9.2 Operation with inert gas

When operating the VDL vacuum drying oven with inert gas, correctly follow the technical ventilation measures according to the local and national regulations relevant for your country (for Germany: DGUV guidelines 213-850 on safe working in laboratories, issued by the employers' liability insurance association).

During operation with inert gas, the chamber is supplied with an oxygen displacing gas (e.g. N₂). Inert gases in high concentrations are hazardous to health. They are colorless and almost odorless and therefore practically imperceptible. Inhalation of inert gases can cause drowsiness up to respiratory arrest. When the O₂ content of the air decreases below 18%, there is risk of death from lack of oxygen. Any gas that might escape has to be led out via good room ventilation or a suitable exhaust system.

| | |
|---|---|
|  |  DANGER |
| | <p>Risk of suffocation due to high concentration of inert gas. Death by suffocation.</p> <ul style="list-style-type: none"> ⊘ Do NOT set up chambers in non-ventilated recesses. ➤ Ensure technical ventilation measures. ➤ Respect the relevant regulations for handling these gases. ➤ When decommissioning the vacuum drying oven, shut off the inert gas supply. |

Install a pressure reducer for inert gas operation. Set the pressure reducer to a pressure slightly above ambient pressure. Ensure that the pressure reducer will open. Do not change this setting in order to avoid perturbation inside the oven and release of big quantities of inert gas after flooding the VDL.

Following evacuation, an inert gas, e.g., nitrogen, is led into the inner chamber via the connection "GAS/AIR" (4) or the optional connection "GAS/AIR 2" (5) until pressure compensation with the atmosphere occurs. Depending on the individual application, you can perform a second evacuation and repeat the inert gas flooding.

When the inert gas fine dosing valve is open, a maximum of approx. 0.6 m³/h gas flows into the inner chamber. The introduction of inert gas by under-flooding in the lower region of the inner chamber rear wall and the extraction at the inner chamber ceiling allow an effective inert gas flushing.



9.9.3 Ventilation / breaking the vacuum in case of a power failure

| | |
|---|--|
|  | <p>The emergency ventilation is intended for the case of a completed drying process</p> |
|---|--|

To be able to open the chamber in case of a power failure, remove the "Manual ventilation" plug (7) for emergency ventilation, which is located on the chamber rear.

| | |
|---|---|
|  | <p>As long as there is a vacuum, never try to open the oven by force.</p> |
|---|---|

| | |
|---|---|
|  | <p>Make sure that the drying procedure is complete before breaking the vacuum. Otherwise, you should wait for the power to return to continue the drying procedure.</p> |
|---|---|

| | |
|---|---|
|  |  DANGER |
| | <p>Explosion hazard through the formation of an explosive atmosphere in the presence of hot surfaces. Serious injury or death from burns and / or explosion pressure.</p> <ul style="list-style-type: none"> ⊘ Do NOT remove the "Manual ventilation" plug, as long as the drying process is still running. |

9.9.4 Ventilation before completing the drying procedure (flooding with ambient air or inert gas)

If possible, avoid terminating the drying process. If it is nevertheless to be done, it is essential to observe the following instructions!

Safety during the drying process: The vacuum during drying prevents the presence of an explosive atmosphere in the interior of the chamber. At the start of the drying process, the heater is therefore only released at a pressure of 100 mbar. In addition, the maximum temperature is limited so that, with correct load, there is no risk of ignition from hot surfaces.

Error: If incorrect loading with an inadmissible solvent (auto-ignition temperature $<200\text{ }^{\circ}\text{C}$) has occurred, proceed as follows



- Disconnect the power plug and turn off the pump.
- Let the chamber cool down to room temperature.
- Do NOT remove the “Manual ventilation” plug.
- Only ventilate when the interior temperature has cooled to room temperature. Only then open the door.

Hazard when opening the door after ventilation: After incorrect loading, open the door only when the inner temperature has sunk to ambient temperature.

| | |
|---|---|
|  | <p>Prior to a termination of a not completed drying process make sure that the auto-ignition temperature of the solvent has been determined correctly, and that the drying temperature reached far below this. In case of doubt, do not interrupt the drying process!</p> |
|---|---|

Proceeding to terminate the drying process:

- Set the temperature set-point to approx. ambient temperature
- Let the chamber cool down to ambient temperature
- Set the pressure set-point to approx. atmospheric pressure

| | |
|--|---|
|  |  DANGER |
| | <p>Explosion hazard through the formation of an explosive atmosphere in the presence of hot surfaces after incorrect loading Serious injury or death from burns and / or explosion pressure.</p> <ul style="list-style-type: none"> ⊘ Do NOT use ambient air to break the vacuum as long as the chamber is hot. Do NOT remove the “Manual ventilation” plug as long as the drying process is still running. ➤ Let the chamber cool down to room temperature before opening the door. |

9.10 Unloading the loading material

| | |
|---|--|
|  | <p>Do not unload the loading material without technical ventilation.</p> |
|---|--|

Note the following points before unloading the loading material:

When unloading the loading material also in the context of intended use, an explosive mixture may form in the working space. Therefore, a safety area of min. 1 m in front of the oven must be considered.

- Activate Standby mode on the controller before opening the door.
- Ensure equipotential bonding: The accessible installation and operating area in front of the equipment must be conductive. This installation and operating area must be connected to the vacuum drying oven and other equipment according to the grounding plan (chap. 6.8).
- Activate the technical ventilation (extraction):
 The operator shall provide active extraction (technical ventilation according to country-specific regulations – TRBS 2152 Part 2 for Germany) prior to commissioning the oven. Extraction must include the entire installation area of the vacuum drying oven. Unloading the loading material must take place in the safety area in front of the oven with technical ventilation.
- The personal protective equipment (PPE) of the operating personnel must be implemented ESDprotected.
- Sweep the area for electrical equipment, preheating chamber, and controller housing at least 10 minutes with compressed air (recommended).

9.11 Removing the full condensate catchpot of the pump



Do not remove the full condensate catchpot of the pump without technical ventilation

Note the following points before removing the condensate catchpot:

When removing the condensate catchpot spilling of the solvent may occur.

- Ensure equipotential bonding:
The accessible installation and operation area of the equipment must be conductive. This area and the vacuum pump must be connected with the vacuum drying oven according to the grounding plan (Chap. 6.8).
- Activate the technical ventilation (extraction):
The operator shall provide active extraction (technical ventilation according to country-specific regulations – TRBS 2152 Part 2 for Germany) prior to manipulating the condensate catchpot of the pump. Extraction must include the entire installation area of the VDL and the vacuum pump, especially the area of the catchpot (when removing it) and the exhaust air of the vacuum pump. Removing the full condensate catchpot must take place under technical ventilation.
- Use ESD protected personal protective equipment:
The personal protective equipment (PPE) of the operating personnel must be implemented ESD protected. This includes also gloves.

9.12 Preparing a new drying process

Before starting a new drying process with a different auto-ignition temperature, determine the auto-ignition temperature of the solvent according to its safety data sheet. In the case of solvent mixtures, use the lowest auto-ignition temperature.

Check all settings (drying temperature, pressure set-point and safety controller setting). If appropriate, make sure that the new temperature set-point and safety controller value are entered on the controller.



With each change of the temperature set-point, observe the safety controller setting.

10. Set-point entry

| | Setting ranges | Control ranges |
|-------------|--------------------------------------|---|
| Temperature | 0.0 °C / 32 °F up to 110 °C / 230 °F | 10 °C / 18 °F above ambient temperature up to 110 °C / 230 °F |
| Pressure | 0 mbar up to 1100 mbar | 0 mbar up to 1100 mbar |



After starting the drying procedure, the heater is activated only when the pressure reaches or falls below the required pressure threshold of 100 mbar.

Solvents and resulting vapors can ignite at excessive drying temperatures.



DANGER

Fire and explosion hazard when exceeding the auto-ignition temperature of the solvent due to excess drying temperature.

Serious injury or death from burns and / or explosion pressure.

- Make sure that only solvents with an auto-ignition temperature that is higher than 200 °C / 392 °F may be entered into the chamber. Check the auto-ignition temperature with the safety specifications of the solvent. In the case of solvent mixtures, use the auto-ignition temperature of the material with the lowest auto-ignition temperature.

In Fixed value operating mode, you can enter a temperature set-point, a pressure set-point, and the switching-state of special controller functions.

All settings made in Fixed value operating mode remain valid until the next manual change. They are saved also when turning off the chamber or in case of toggling to Program Mode.



The values entered in Fixed value mode become valid again after the end of a program and will then be targeted and equilibrated.



When operating without a vacuum by setting “Pressure control off” (chap. 11.5), the pressure tolerance range function is automatically deactivated.

10.1 Set-point entry through the “Setpoints” menu



Press the **Setpoint setting** icon to access the “Setpoint” setting menu from Normal display.

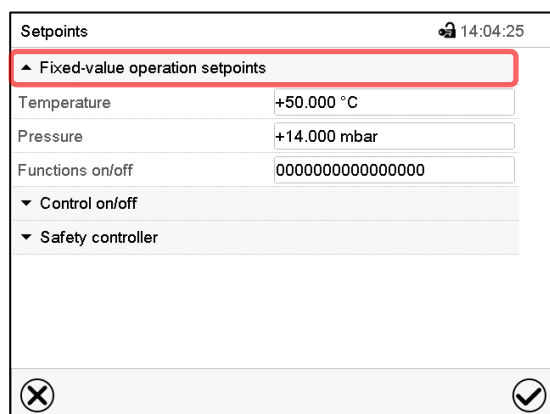

Setpoints 14:04:25

▲ Fixed-value operation setpoints

Temperature +50.000 °C

Pressure +14.000 mbar

Functions on/off 0000000000000000

▼ Control on/off

▼ Safety controller

⊗ ⊙

“Setpoints” menu.

Select “Fixed value operation setpoints” to access the individual parameters.

- Select the field “Temperature” and enter the desired temperature setpoint.
Confirm entry with **Confirm** icon.
- Select the field “Pressure” and enter the desired pressure setpoint.
Confirm entry with **Confirm** icon.



When entering a value outside the setting range, the message: “Value outside of limits! (Min: xxx, Max: xxx)” appears (xxx is a wildcard for the limits of the respective parameter). Press the **Confirm** icon and repeat the entry with a correct value.

After completing the settings, press the **Confirm** icon to take over the entries and exit the menu, **or** press the **Close** icon to exit the menu without taking over the entries.



With set-point type “**Limit**”, adapt the safety controller (chap. 14.2) always when you changed the temperature set-point. Set the safety controller set-point by approx. 5 °C above the controller temperature set-point.
Recommended setting: Set-point type “**Limit**” with safety controller set-point 5 °C.



As long as the pressure threshold of 100 mbar has not yet been reached, the icon “Pressure threshold not reached” in the screen header in Normal display. Press the flash icon next to the information icon to access the corresponding text information “Pressure threshold not reached” (Information messages, chap. 16.1)

10.2 Direct setpoint entry via Normal display

Alternatively, you can also enter the setpoints directly via Normal display.

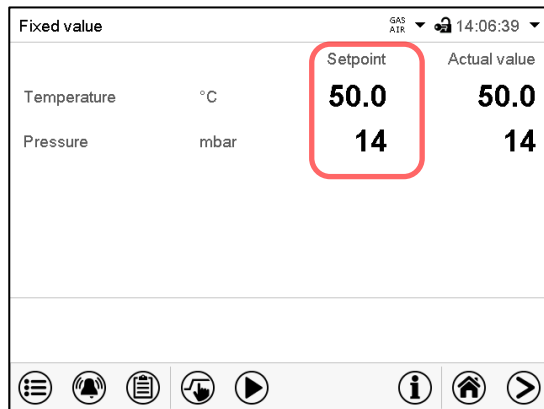

Normal display. Select the setpoint you want to change.

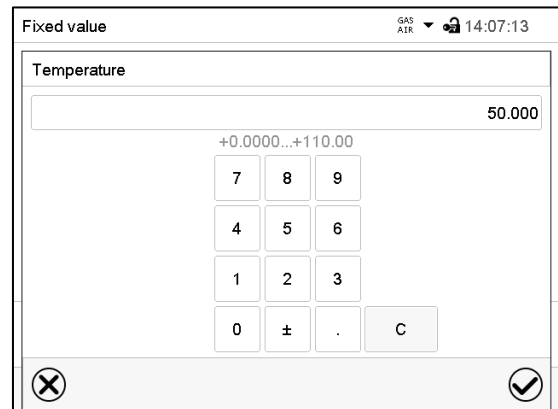

Example: “Temperature” entry menu. Enter the desired setpoint and confirm entry with **Confirm** icon.

11. Setting special controller functions

You can set the following functions via the controller menu:

- Activate / deactivate the Standby mode (chap. 9.5)
- Use the optional connection “GAS/AIR2” (10) for ventilation (chap. 11.2)
- Close all existing fine dosing valves (chap. 11.3)
- Turning on / off temperature control (chap. 11.4)
- Turning on / off pressure control (chap. 11.5)
- Starting / terminating the drying monitoring (chap. 11.6)

11.1 Menu structure

11.1.1 “Functions on/off” menu

This chapter describes the setting with operating mode Fixed value operation. Settings for program operation are described in chap. 18.7.3 (time programs) and chap. 19.6.5 (week programs).

In the “**Functions on/off**” menu you can define the switching state of three controller functions.

 Press the **Setpoint setting** icon to access the “Setpoint” setting menu from Normal display.

Path: [Setpoint](#) > [Fixed value operation setpoints](#) > [Functions on/off](#)

- Function “Standby” (chap. 9.5)
- Function “GAS/AIR 2” (chap. 11.2)
- Function “Close all valves” (chap. 11.3)

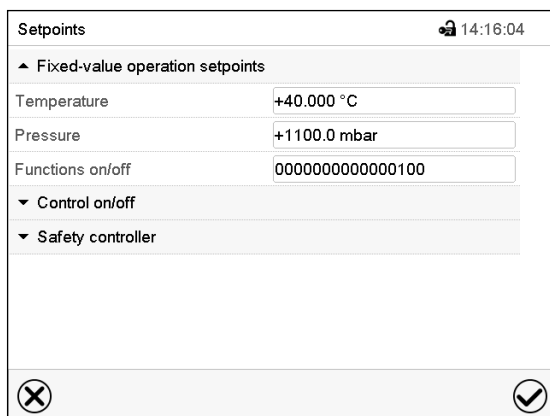

“Setpoints” menu.

Select the field “Functions on/off”.

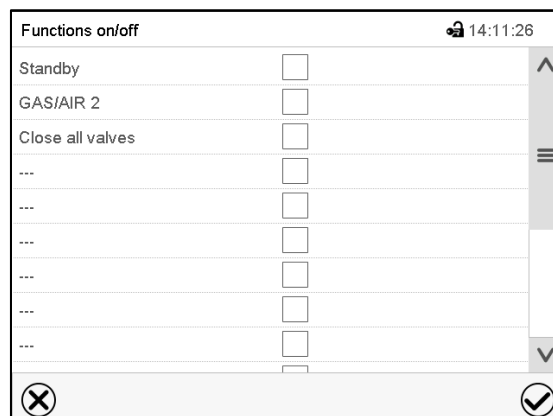

“Functions on/off” entry menu.

Mark / unmark the checkbox to activate / deactivate the desired function and press the **Confirm** icon

The functions are displayed from right to left.

Activated function: switching status “1” (On)

Deactivated function: switching status “0” (Off)

Example:

Activated function “Standby” = 000000000000000000000001

Deactivated function “Standby” = 000000000000000000000000

11.1.2 “Control on/off” menu

More functions are available via the “Control on/off” menu.



Press the **Setpoint setting** icon to access the “Setpoint” setting menu from Normal display.

Path: **Setpoint > Control on/off**

- Function “Temperature” (temperature control, chap. 11.4)
- Function “Pressure” (pressure control, chap. 11.5)

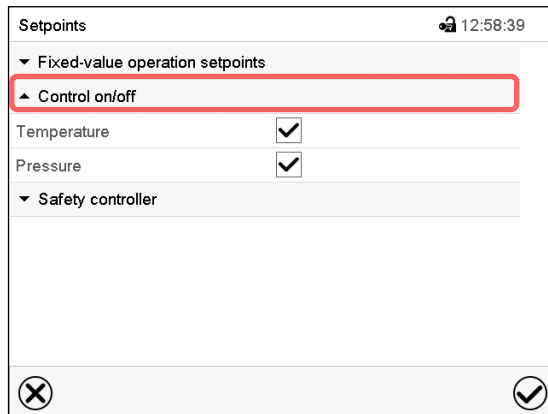

“Setpoints” menu.

Select the field “Control on/off”.

Mark / unmark the checkbox to activate / deactivate the desired function and press the **Confirm** icon

11.2 Using the optional universal connection “GAS/AIR 2” for ventilation

Regularly the universal connection for inert gas / ambient air “GAS/AIR” (4) is used for ventilation.

The “GAS/AIR 2” function serves to close the valve of the standard connection “GAS/AIR” (4) and activate the valve of the optional universal connection “GAS/AIR 2” (5), which is then used for ventilation

This allows convenient switching when both connections are used differently (e.g., for inert gas and ambient air).



If you activate the “GAS/AIR 2” function on a chamber, which is NOT equipped with the optional universal connection for inert gas / ambient air “GAS/AIR 2” (5), ventilation is no longer possible!



Press the **Setpoint setting** icon to access the “Setpoint” setting menu from Normal display.

Path: **Setpoint > Fixed value operation setpoints > Functions on/off**

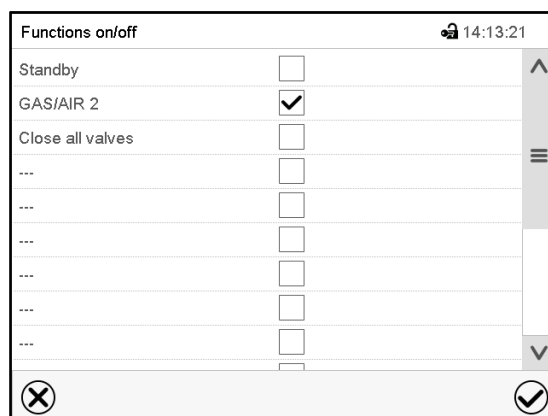

“Functions on/off” menu.

Mark the checkbox of the function “GAS/AIR 2” to activate it and press the **Confirm** icon.

In the “Setpoints” menu press again the **Confirm** icon. The controller changes to Normal display.

| | |
|---|---|
|  | <p>When the function “GAS/AIR 2” is activated, the “GAS/AIR 2” icon is displayed in the screen header in Normal display. Press the flash icon next to the information icon to display the corresponding text information “GAS/AIR 2” (information messages, chap. 16.1)</p> |
|---|---|

11.3 Close all valves

Close all existing fine dosing valves

| | |
|---|--|
|  | <p>Press the Setpoint setting icon to access the “Setpoint” setting menu from Normal display.</p> |
|---|--|

Path: **Setpoint > Fixed value operation setpoints > Functions on/off**

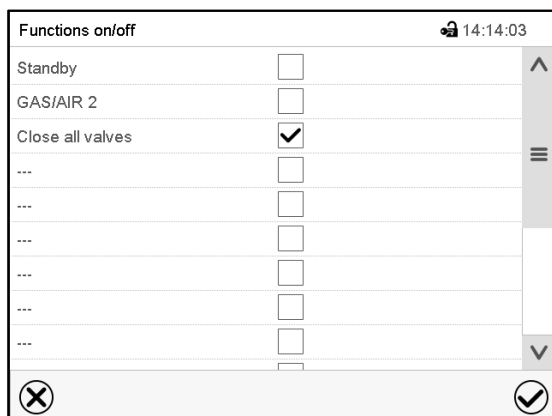

“Functions on/off” menu.

Mark the checkbox of the function “Close all valves” to activate it and press the **Confirm** icon.

In the “Setpoints” menu press again the **Confirm** icon. The controller changes to Normal display.

| | |
|---|--|
|  | <p>When the function “Close all valves” is activated, the “All valves closed” icon is displayed in the screen header in Normal display. Press the flash icon next to the information icon to display the corresponding text information “All valves are closed” (information messages, chap. 16.1)</p> |
|---|--|

11.4 Activating / deactivating temperature control

| | |
|---|--|
|  | <p>Press the Setpoint setting icon to access the “Setpoint” setting menu from Normal display.</p> |
|---|--|

Path: **Setpoint > Control on/off**

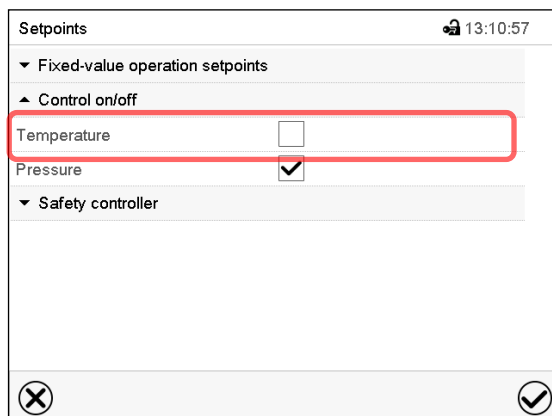

“Setpoints” menu.

Select the field “Control on/off” (example: deactivated temperature control).

Mark / unmark the “Temperature” checkbox to activate / deactivate temperature control and press the **Confirm** icon.

- Checkbox marked: temperature control active
- Checkbox unmarked: temperature control deactivated

The actual temperature value continues to be displayed in Normal display:

| Fixed value | | GAS AIR 10:13:57 | |
|-------------|------|------------------|--------------|
| | | Setpoint | Actual value |
| Temperature | °C | ----- | 41.0 |
| Pressure | mbar | 1100 | 1024 |

Normal display with deactivated temperature control.

11.5 Activating / deactivating pressure control

When operating the chamber without a vacuum connection, you can deactivate pressure control with the to avoid alarms of the pressure system. No pressure tolerance range alarms and no pressure alarm will be emitted.

Evacuation and ventilation via the controller are then no longer possible. The chamber is ventilated.

Press the **Setpoint setting** icon to access the “Setpoint” setting menu from Normal display.

Path: **Setpoint > Control on/off**

| Setpoints | | 13:10:32 | |
|-----------------------------------|--|-------------------------------------|--|
| ▼ Fixed-value operation setpoints | | | |
| ▲ Control on/off | | | |
| Temperature | | <input checked="" type="checkbox"/> | |
| Pressure | | <input type="checkbox"/> | |
| ▼ Safety controller | | | |

“Setpoints” menu.

Select the field “Control on/off” (example: deactivated pressure control).

Mark / unmark the “Pressure” checkbox to activate / deactivate pressure control and press the **Confirm** icon

- Checkbox marked: pressure control active
- Checkbox unmarked: pressure control deactivated

The actual pressure value continues to be displayed in Normal display:

| Fixed value | | GAS AIR 10:14:55 | |
|-------------|------|------------------|--------------|
| | | Setpoint | Actual value |
| Temperature | °C | 40.0 | 40.6 |
| Pressure | mbar | ----- | 1024 |

Normal display with deactivated pressure control.

11.6 Drying monitoring

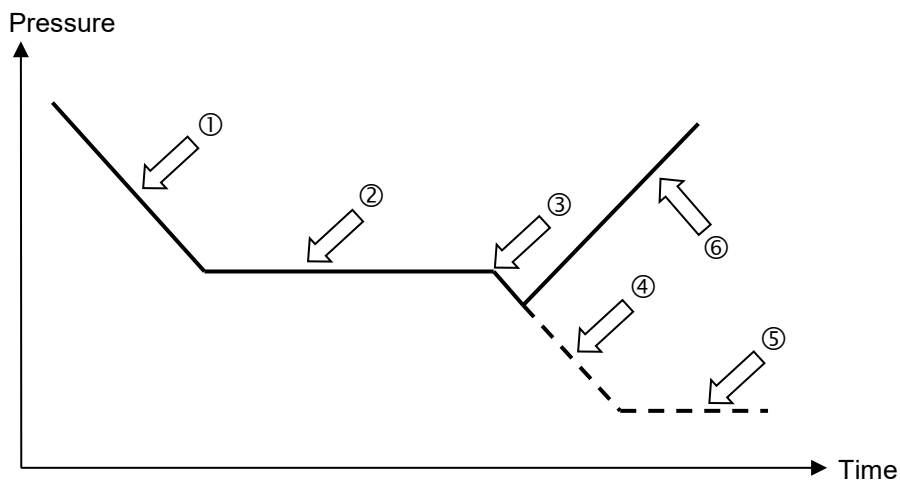

Figure 26: Schematic timing of the drying process and drying monitoring

Procedure:

- Enter the temperature set-point.
The previously entered pressure setpoint is not used with this function. It remains saved.
The drying monitoring uses a fixed minimum pressure setpoint.
- Start the drying monitoring: The vacuum pump is activated; the evacuation valve opens.
Starting from ambient pressure, the pressure starts to decrease. ①
- Depending on the vapor pressure of the solvent, a plateau phase is then reached ② during which the solvent vaporizes. The pressure remains almost constant.
- After the solvent is completely evaporated, drying is complete. ③ The pressure starts to decrease again
Without drying monitoring the pressure would now continue to decrease ④, until the maximum final vacuum is reached. ⑤
- The drying monitoring recognizes this second pressure drop. It turns off the pressure control. The chamber will then be ventilated automatically. ⑥



Prior to starting a new drying process, the pressure control must be activated again (chap. 11.4).

Notes:

If the drying monitoring is aborted during phase ① or ②, the controller will take the current actual pressure value as the pressure setpoint. This overwrites the previously entered pressure setpoint. It can be changed manually at any time.

In processes with low temperatures < 40 °C or thermally poorly coupled items to be dried (e.g. drying of powders), the drying monitoring may incorrectly identify the relevant parameters. In this case, please check the process result and, if necessary, use a process not including this program for such processes.

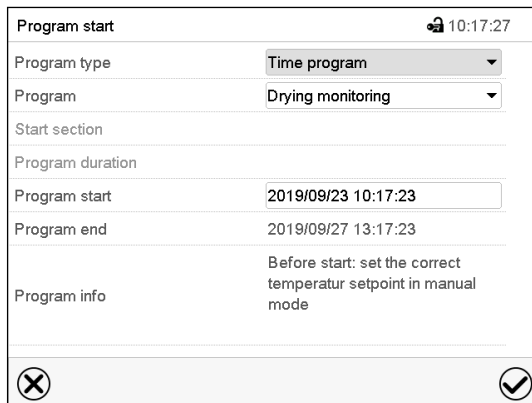
 In Normal display press the **Program start** icon to access the “Program start” menu.



| Program start | | 10:17:27 |
|---|--|---|
| Program type | Time program | |
| Program | Drying monitoring | |
| Start section | | |
| Program duration | | |
| Program start | 2019/09/23 10:17:23 | |
| Program end | 2019/09/27 13:17:23 | |
| Program info | Before start: set the correct temperatur setpoint in manual mode | |
|  | |  |

“Program start” menu with the selected Drying monitoring program.

- In the field “Program” select the setting “Drying monitoring” program.
- Select the field “Program start” and enter the desired program start time in the “Program start” entry menu. Press the **Confirm** icon. The program delay time until program start begins. The program end is calculated automatically.

After completing the settings, press the **Confirm** icon to take over the entries and exit the menu. The program starts running.

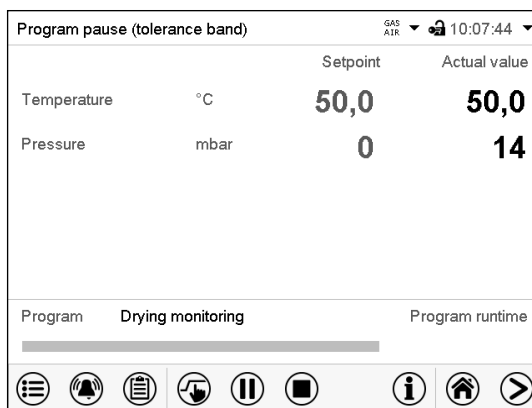
If instead you press the **Close** icon to exit the menu without taking over the entries, the program will not start.

| Program pause (tolerance band) | | GAS AIR | 10:07:44 |
|---|-------------------|----------|-----------------|
| | | Setpoint | Actual value |
| Temperature | °C | 50,0 | 50,0 |
| Pressure | mbar | 0 | 14 |
| Program | Drying monitoring | | Program runtime |
|  | | | |
|  | | | |

Normal display. Information on the bottom of the screen indicates the currently running program and the time already passed. The grey bar shows how much time of the whole time is elapsed.

12. Authorization levels and password protection



We recommend that you also assign a password to the "User" authorization level so that no unauthorized person can use the chamber.

12.1 User management, authorization levels and password protection

The available functions depend on the current authorization level "Master", "Service", "Admin" or "User".

The authorization levels are hierarchical: Every authorization includes all functions of the next lower level.

"Master" authorization level

- Highest authorization level, only for developers
- Extensive authorization for controller operation and configuration, outputs/inputs, alarm settings, parameter sets and operating ring display
- All passwords can be changed in the "log out" submenu (chap. 12.3).

"Service" authorization level

- Authorization level only for BINDER service
- Extensive authorization for controller operation and configuration, access to service data
- The passwords for "Service", "Admin" and "User" authorization levels can be changed in the "log out" submenu (chap. 12.3).

"Admin" authorization level

- Expert authorization level, for the administrator
- Authorization for controller configuration and network settings and for operating those controller functions required for operating the chamber. Restricted access to service data.
- Password (factory setting): "2".
- The passwords for "Admin" and "User" authorization levels can be changed in the "log out" submenu (chap. 12.3).

"User" authorization level

- Standard authorization level for the chamber operator
- Authorization for operating the controller functions required for operating the chamber.
- No authorization for controller configuration and network settings. The "Settings" and "Service" submenus of the main menu are not available.
- Password (factory setting): "1"
- The password for the "User" authorization level can be changed in the "log out" submenu (chap. 12.3).

As soon as a password has been assigned for an authorization level, the access to this level and the related controller functions are only available after log-in with the appropriate password.

If for an authorization level no password is assigned, the related controller functions of this level are available for every user without login.

If passwords have been assigned for all authorization levels, access to the controller functions is locked without login.

Operation after user login

At user login, the authorization level is selected and confirmed by entering the respective password.

Following user login, controller operation is available, recognizable by the open-lock icon in the header. The available controller functions correspond to the user's authorization level.

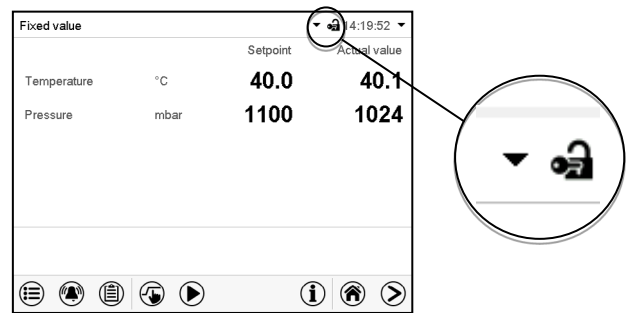

Password protection activated for all levels: operation without user login is locked

If passwords have been assigned for all authorization levels, the controller is locked without registration of a user.

As long as no user is registered, controller operation is locked, recognizable at the closed-lock icon in the header. This requires that the user management has been activated by the assignment of passwords for the individual authorization levels.

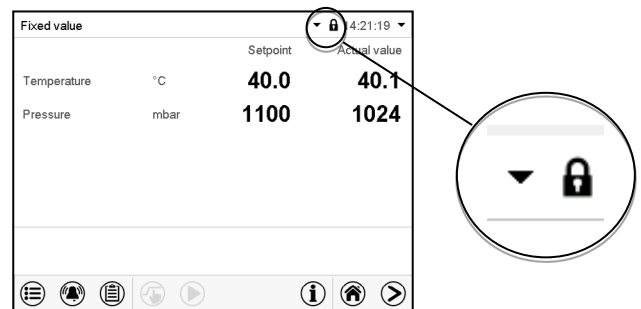

Password protection for at least one level deactivated: operation without user login is possible

If passwords have not been assigned for all authorization levels, after turning on the chamber there are those controller functions available, which correspond to the highest authorization level without password protection.

No lock icon is shown in the display header.

User login is neither required nor possible.

To activate the password protection and user login, perform new password assignment (chap. 12.5.3).

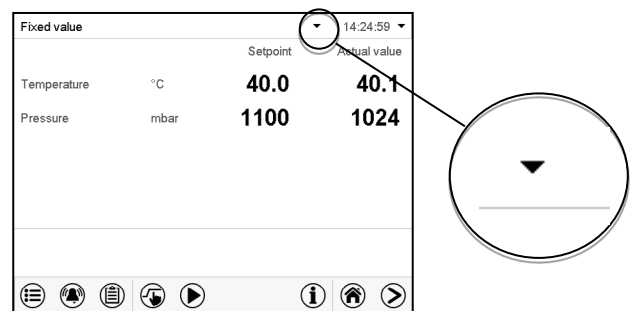

Information window

To check the authorization level of the user currently logged-in, select in Normal display the arrow far right in the display header.



The information window shows date and time, the controller's free memory space and under "Authorization" the authorization level of the current user.

If passwords have been assigned for all authorization levels, a user without login (password entry) has no authorization. There are only viewing functions available.

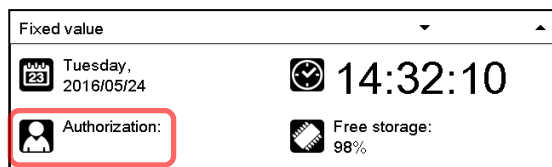

Display when all authorization levels are password protected and no user has logged in:
No authorization level is displayed.

If passwords have been assigned only for some of the authorization levels, a user without login (password entry) has access to the functions of the highest authorization level without password protection.



Display when only some of the authorization levels are password protected (example: no protection for the "User" and "Admin" levels) and no user has logged in:

The user's effective authorization (due to lack of password protection) is shown.

Example: user with "Admin" authorization.

If passwords have been assigned for some or all of the authorization levels, user login (password entry) provides the authorization for the corresponding password-protected level.



Display when at least some of the authorization levels are password protected and a user has logged in.

The user's authorization (by password entry) is shown.

Example: user with "Admin" authorization.

12.2 Log in

Path: [Main menu](#) > [User](#) > [Log in](#)

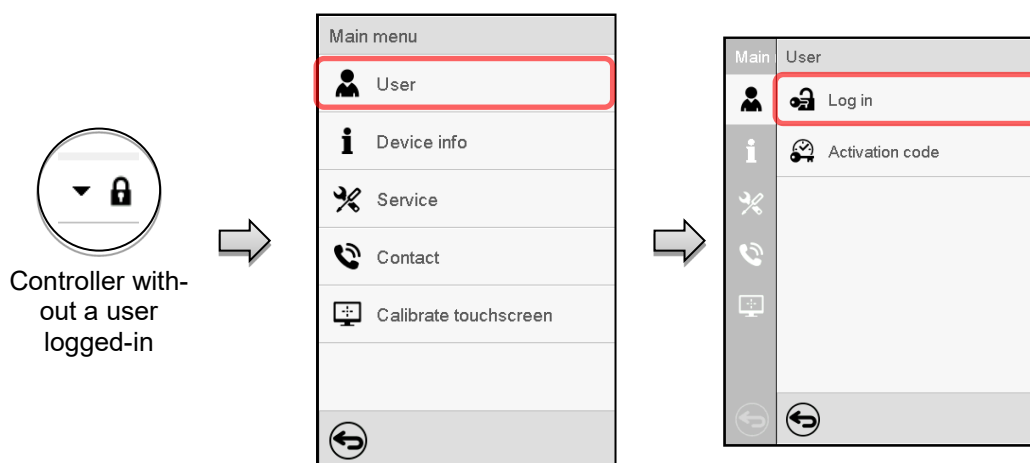

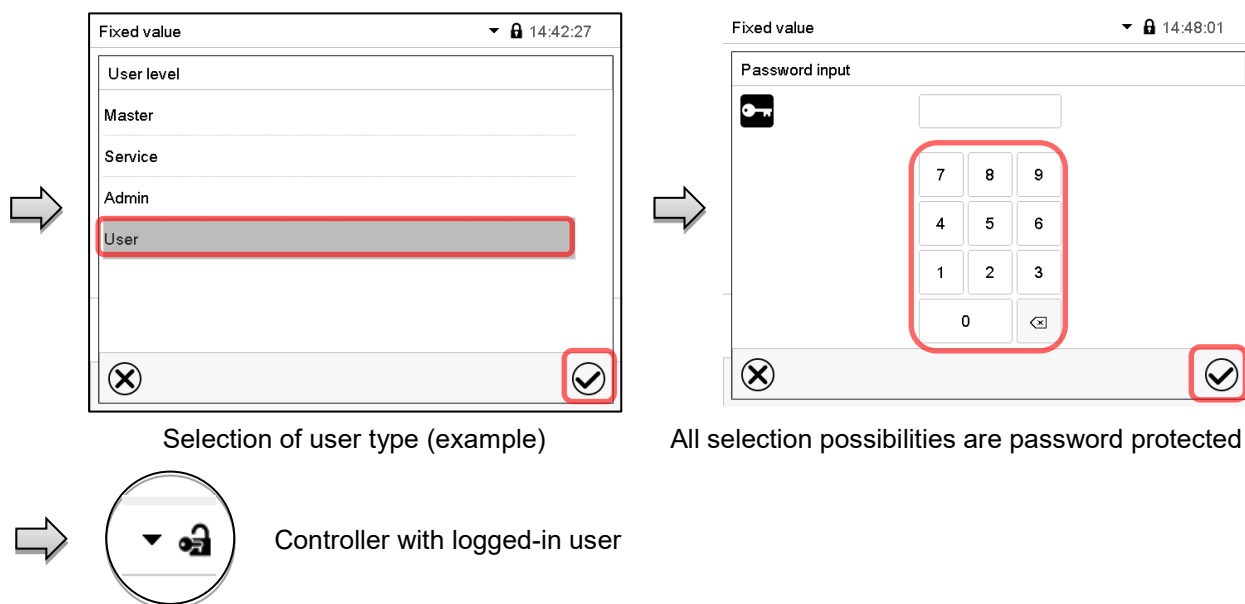

After completing the settings, press the **Confirm** icon to take over the entries and exit the menu, **or** press the **Close** icon to exit the menu without taking over the entries.

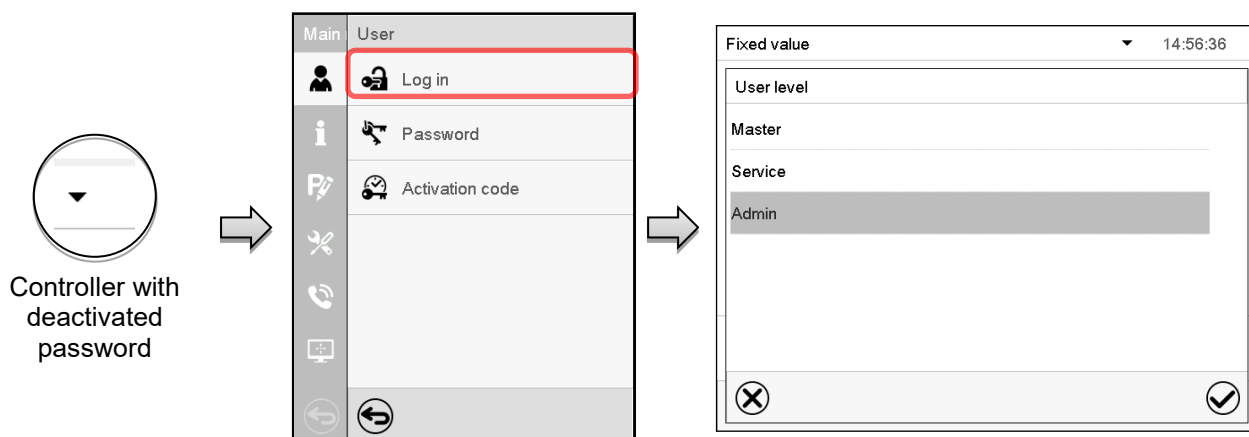

12.3 Log out

Path: [Main menu](#) > [User](#) > [Log out](#)

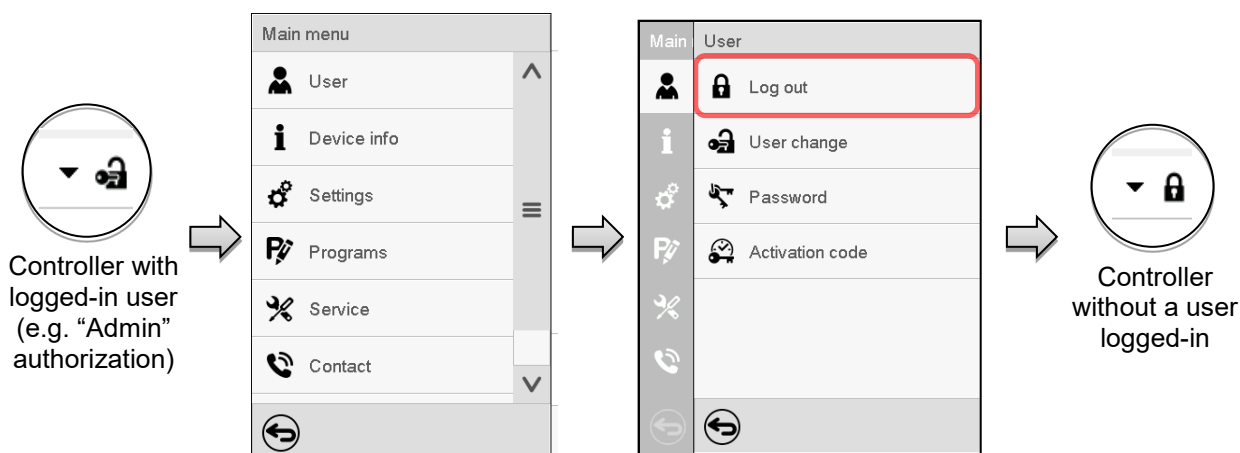

12.4 User change

If the password function has been deactivated (chap.12.5.2) this function is not available.

Path: [Main menu](#) > [User](#) > [User change](#)

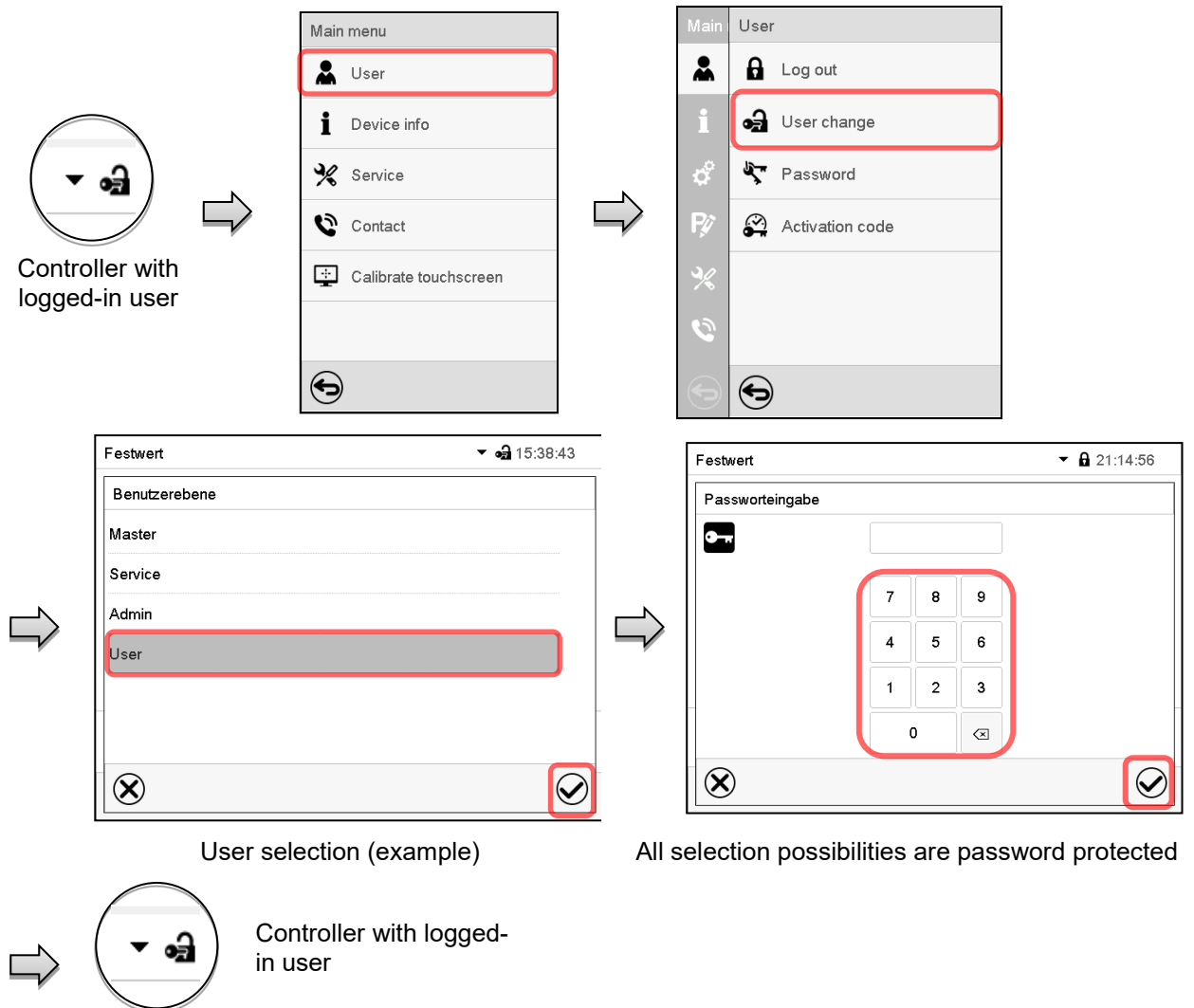

12.5 Password assignment and password change

This function is not available for a user logged-in with “User” authorization.

12.5.1 Password change

A logged-in user can change the passwords of his current level and of the next lower level(s).

Example: A user with “Admin” authorization can change the passwords for the “Admin” and “User” authorization levels.

Path: **Main menu > User > Password**

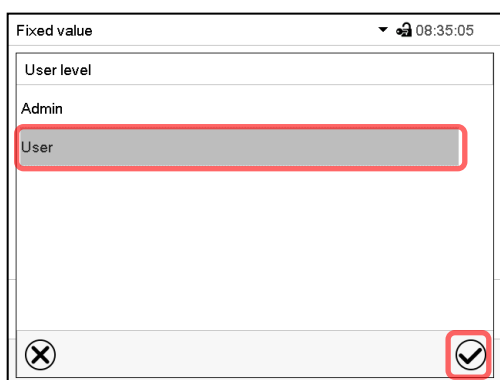
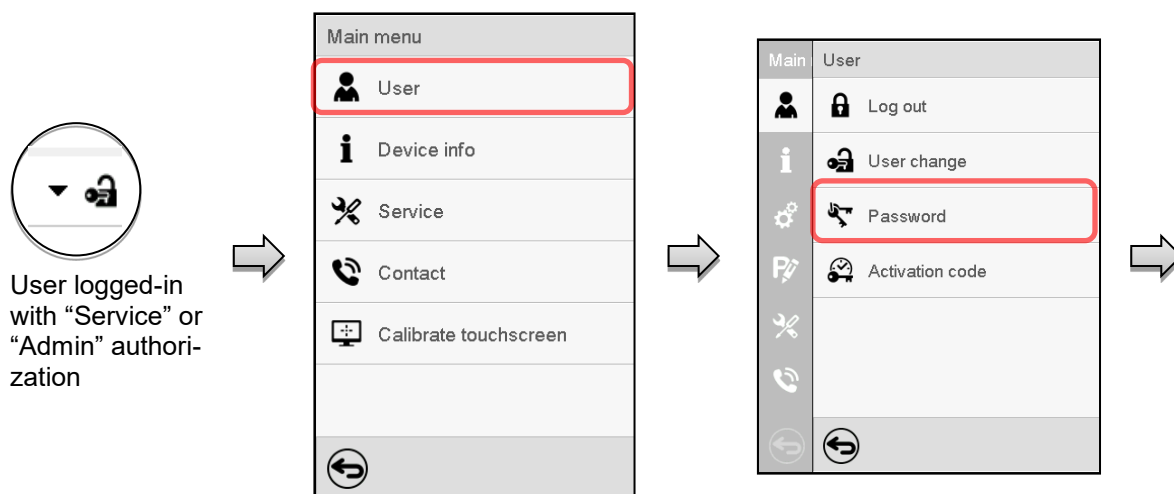

Selection of the authorization level (example: view with "Admin" authorization)

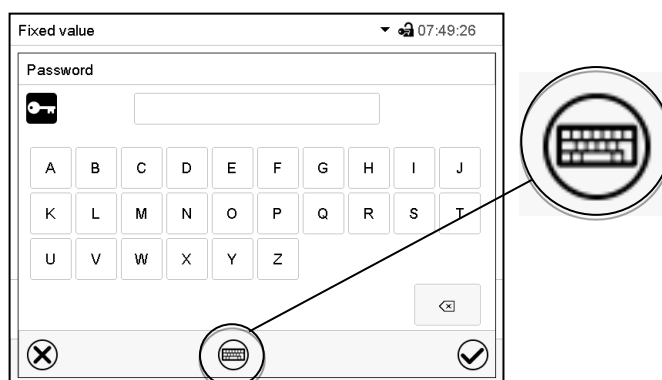

Enter desired password. If desired, press the **Change keyboard** icon to access other entry windows.

In the "Keyboard switch" window you can select different keyboards to enter uppercase and lowercase letters, digits, and special characters. All types of characters can be combined within one single password.

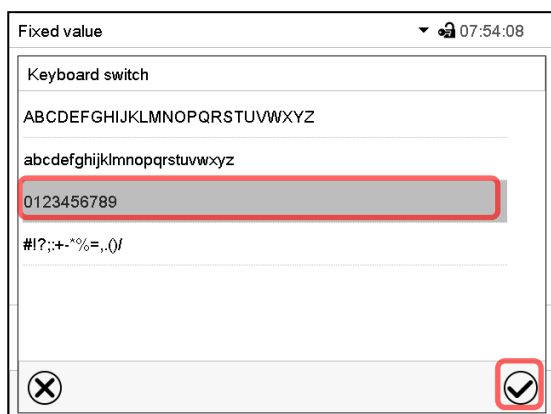

Example: access the digit entry window

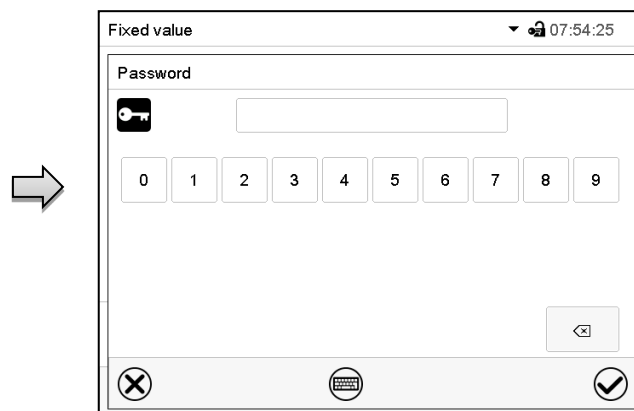

Entry of digits

To confirm the entry, press the **Confirm** icon.

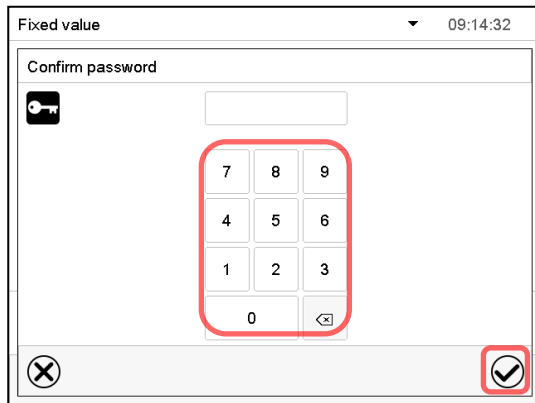

Repeat the password entry for confirmation (sample picture). For each character of the password, the required keyboard appears automatically. Then press the **Confirm** icon.

12.5.2 Deleting the password for an individual authorization level

A user logged-in with “Service” or “Admin” authorization can delete the passwords of his current level and of the next lower level(s). To do this no password is entered during a password change.

Path: [Main menu](#) > [User](#) > [Password](#)

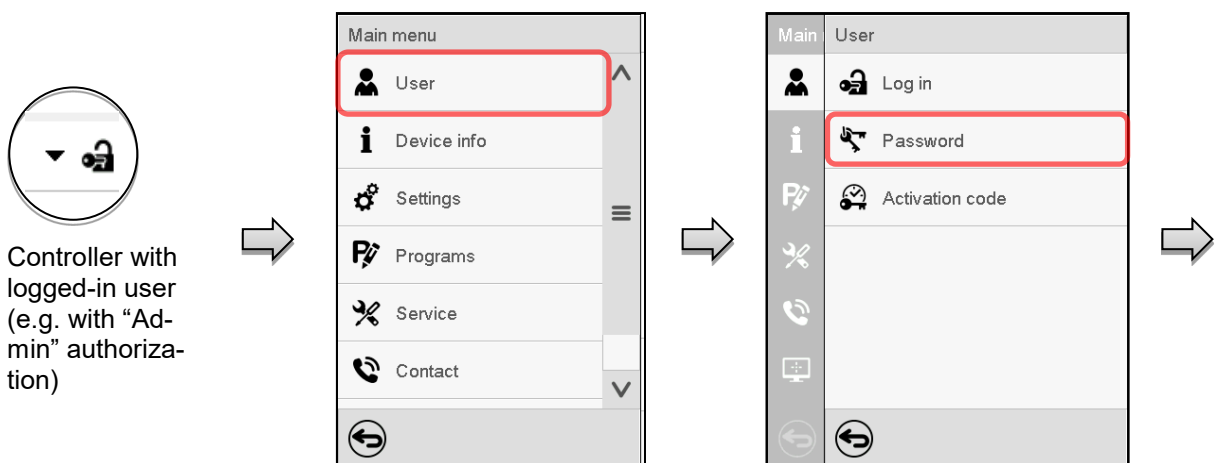

Controller with logged-in user (e.g. with “Admin” authorization)

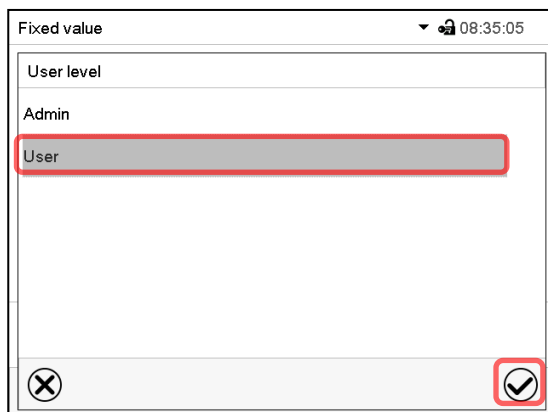

Select the authorization level for which the password shall be deleted.

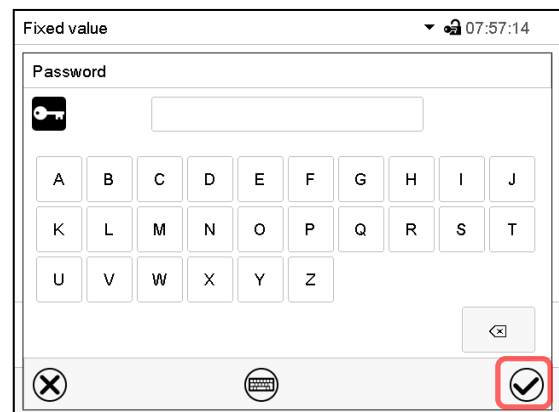

Do NOT enter anything in the “Password” screen. Press the **Confirm** icon.

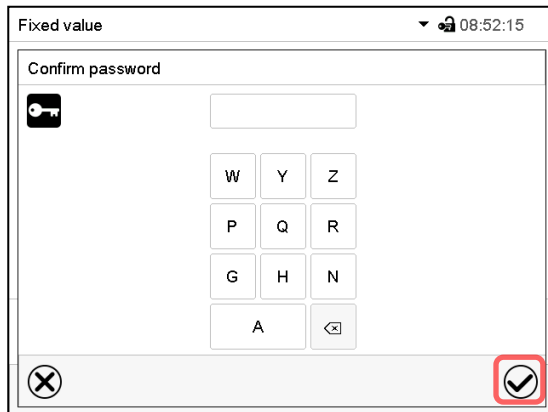

➔ The password is deleted.

Do NOT enter anything in the “Confirm password” screen. Press the **Confirm** icon.

12.5.3 New password assignment for “service” or “admin” authorization level when the password function was deactivated

If the password protection for an authorization level has been deactivated, i.e., no password is assigned, no login for this level is possible. Therefore, access to this authorization level is available without login.

If the password for the “Service” or “Admin” authorization has been deleted (chap. 12.5.2), a new password can be assigned for the current level and the next lower level(s) without user login.

Example: The password for the “Admin” authorization level was deleted, therefore every user without login has full access to the functions of the “Admin” authorization level. If access to this level shall become password protected again, the user can assign a new password for the “Admin” authorization level with the “Password” function.

Path: [Main menu](#) > [User](#) > [Password](#)

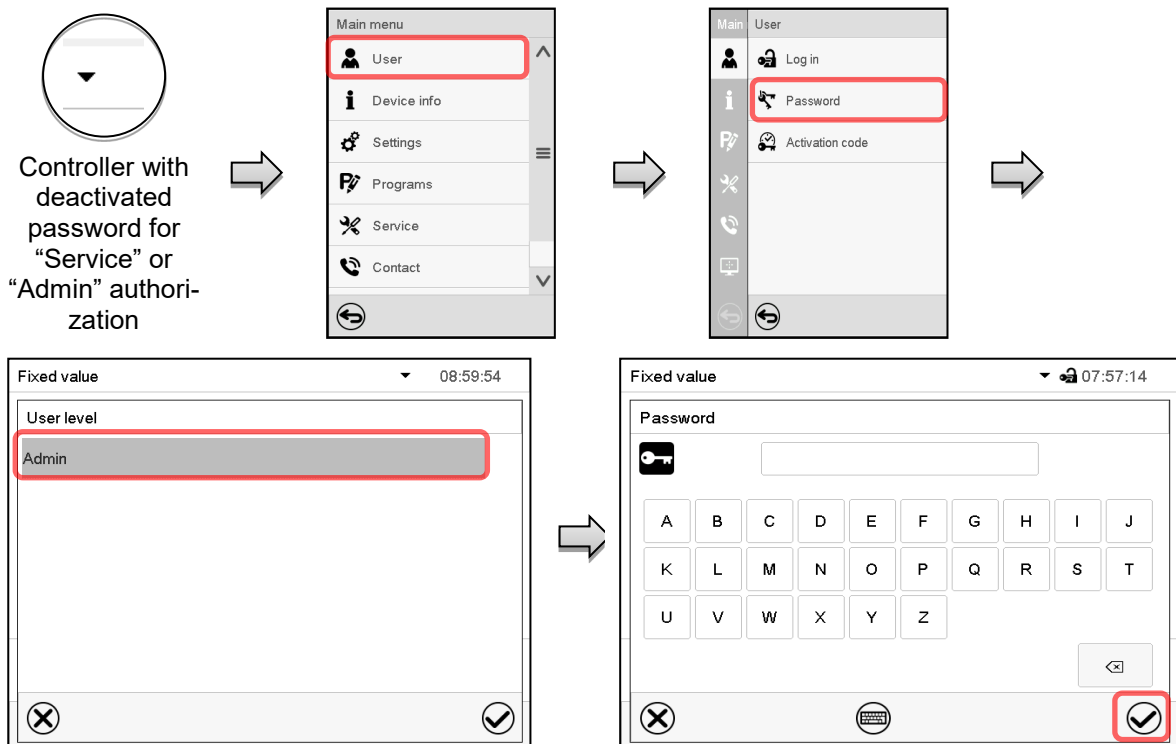

Select the authorization level, for which you want to assign a password.
(Example: “Admin” authorization)

Enter the desired password. If desired, press the **Change keyboard** icon to access other entry windows.

To confirm the entry, press the **Confirm** icon.

Repeat the password entry for confirmation. For each character of the password, the required keyboard appears automatically. Then press the **Confirm** icon.

12.6 Activation code

Certain functions of the controller can be unlocked with a previously generated activation code.

The activation code enables access to functions available only in the “Service” authorization level by users without a “Service” authorization. Such functions include e.g., adjustment or extended configurations.

The activation code is available in authorization levels.

Path: **Main menu > User > Activation code**

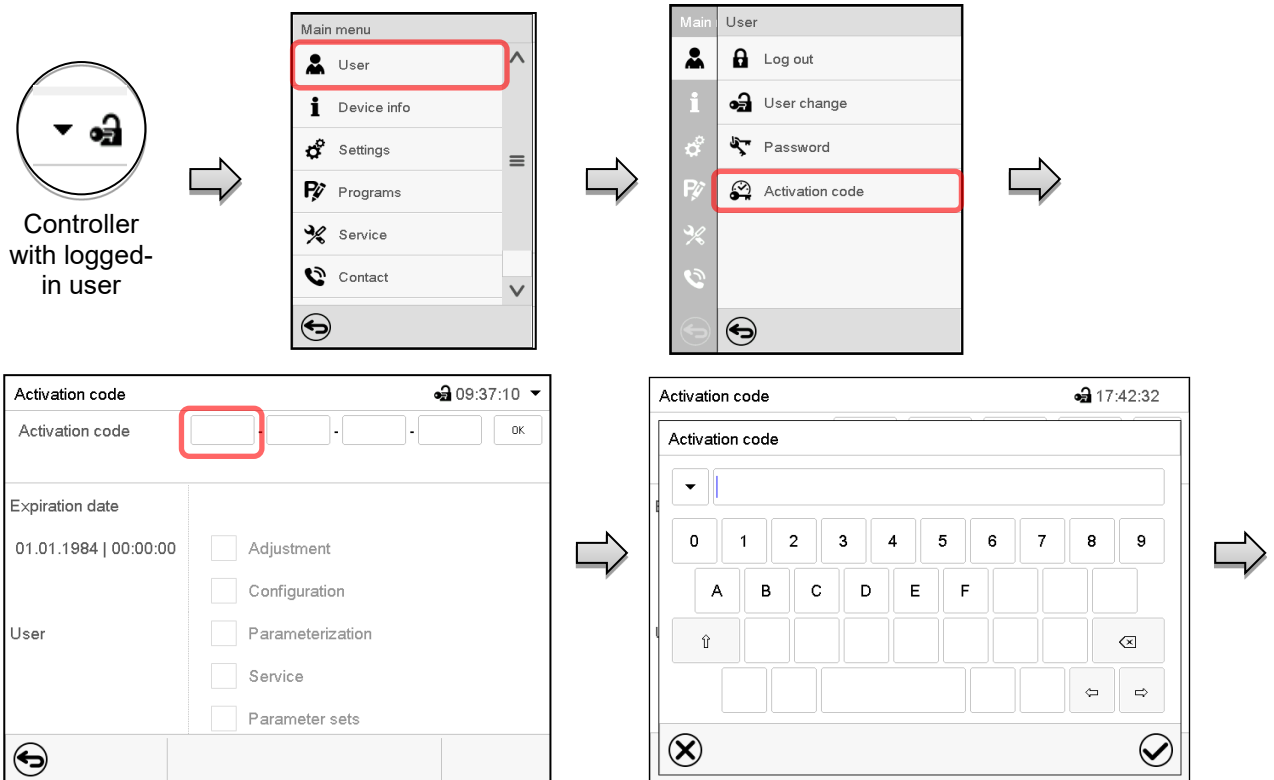

Activation code menu.

Select the first of the four entry fields.

Activation code entry window.

Enter the first four characters of the activation code and press the **Confirm** icon.

Select the next of the four entry fields and proceed accordingly until the entire code has been entered.

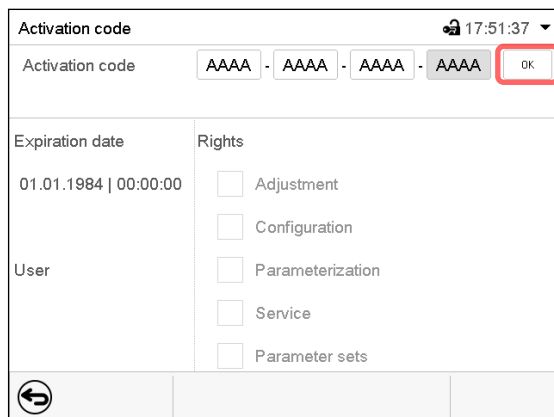

“Activation code” menu with entered code (sample view). Press **OK** to take over the entry.

The available functions are indicated by marked checkboxes.

Example: Extended configurations available.

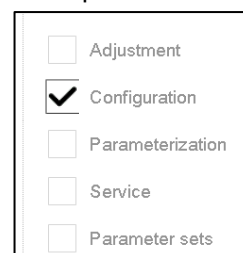

Under “Expiration date” the date of expiry of the code is displayed.

13. General controller settings and information

Most of the general settings can be accessed in the “Settings” submenu, which is available for users with “Service” or “Admin” authorization level. It serves to enter date and time, select the language for the controller menus and the desired temperature unit and to configure the controller’s communication functions.

13.1 Selecting the controller’s menu language

The MB2 program controller communicates by a menu guide using real words in German, English, French, Spanish, and Italian.

Path: [Main menu](#) > [Settings](#) > [Chamber](#)

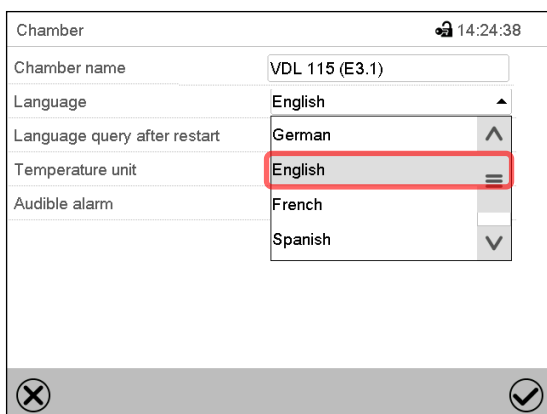

The screenshot shows the 'Chamber' submenu with the following settings:

- Chamber name: VDL 115 (E3.1)
- Language: English
- Language query after restart: German
- Temperature unit: English
- Audible alarm: French

The 'English' option for the temperature unit and the 'German' option for the language query after restart are highlighted with a red box.

“Chamber” submenu.
Select the desired language.

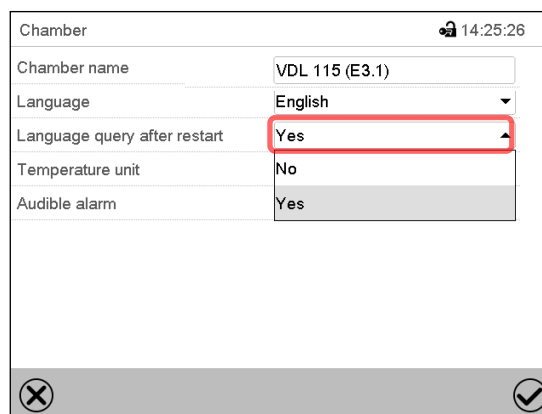

The screenshot shows the 'Chamber' submenu with the following settings:

- Chamber name: VDL 115 (E3.1)
- Language: English
- Language query after restart: Yes
- Temperature unit: No
- Audible alarm: Yes

The 'Yes' option for the language query after restart is highlighted with a red box.

“Chamber” submenu.
Select if there shall be a language query after restarting the chamber and press the **Confirm** icon.

Return to Normal display with the **Back** icon to take over the entries.

13.2 Setting date and time

Following start-up of the chamber after language selection:

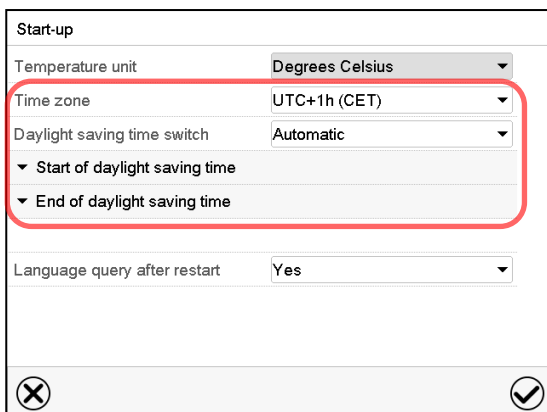

The screenshot shows the 'Start-up' submenu with the following settings:

- Temperature unit: Degrees Celsius
- Time zone: UTC+1h (CET)
- Daylight saving time switch: Automatic
- Start of daylight saving time: (dropdown)
- End of daylight saving time: (dropdown)
- Language query after restart: Yes

The 'Time zone' and 'Daylight saving time switch' options are highlighted with a red box.

Select the time zone and configure the daylight-saving time switch.

Or later:

Path: **Main menu > Settings > Date and time**

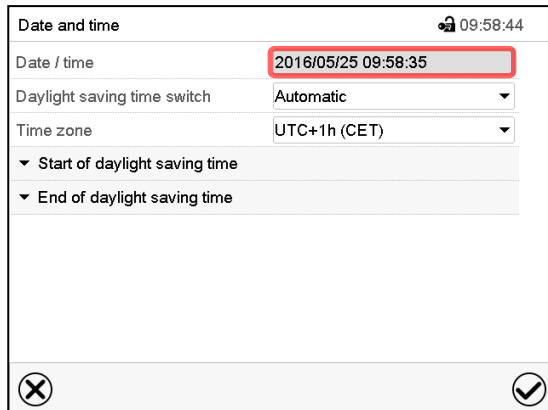

“Date and time” submenu.
Select the field “Date / time”.

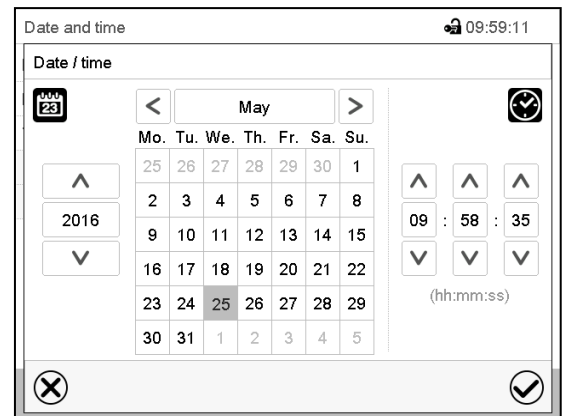

“Date / time” entry menu.
Enter date and time and press the **Confirm** icon.

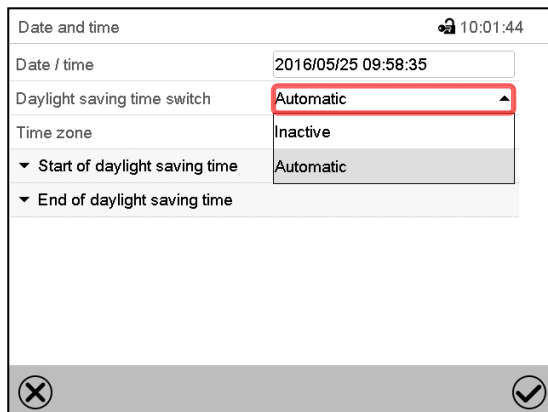

“Date and time” submenu.
In the field “Daylight saving time switch” select the desired setting “Automatic” or “Inactive”.

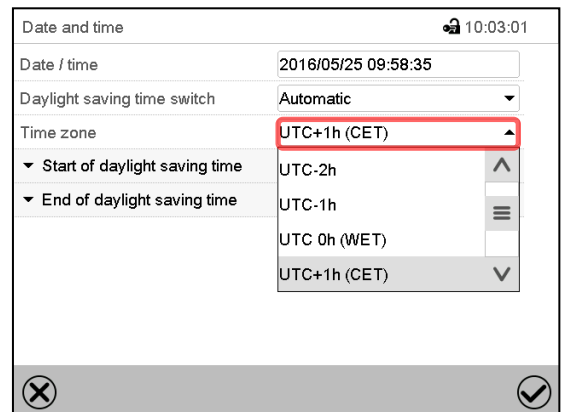

“Date and time” submenu.
Select the desired time zone and press the **Confirm** icon.

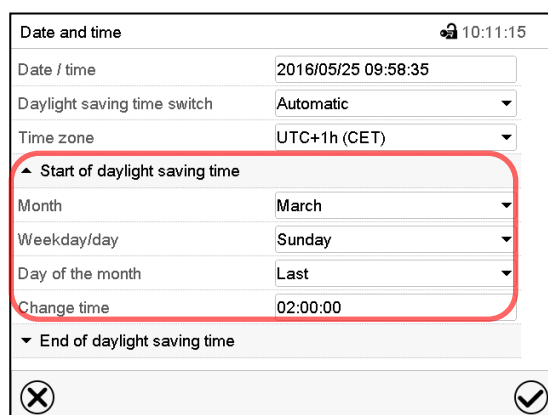

“Date and time” submenu.
Select the desired start of the daylight saving time.

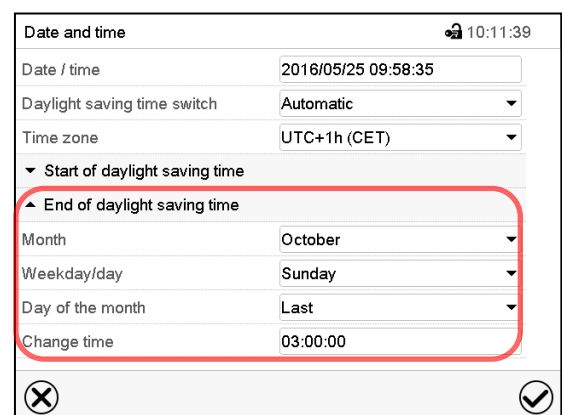

“Date and time” submenu.
Select the desired end of the daylight saving time and press the **Confirm** icon.

After completing the settings, press the **Confirm** icon to take over the entries and exit the menu, **or** press the **Close** icon to exit the menu without taking over the entries.

13.3 Selecting the temperature unit

Following start-up of the chamber:

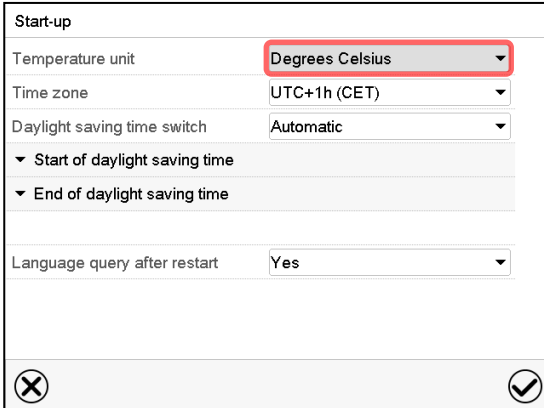

Or later:

Path: [Main menu](#) > [Settings](#) > [Chamber](#)

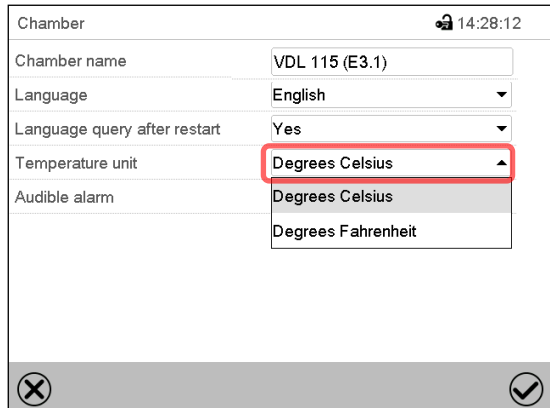

Select the desired temperature unit and press the **Confirm** icon.

Change of the temperature unit between °C and °F.

If the unit is changed, all values are converted accordingly

| | | | |
|--|-----------------------|----------------|---|
|  | C = degree Celsius | 0 °C = 31°F | Conversion: [value in °F] = [value in °C] * 1,8 + 32 |
| | F = degree Fahrenheit | 100 °C = 212°F | |

13.4 Display configuration

13.4.1 Adapting the display parameters

This function serves to configure parameters like display brightness and operating times.

Path: [Main menu](#) > [Settings](#) > [Display](#) > [Display](#)

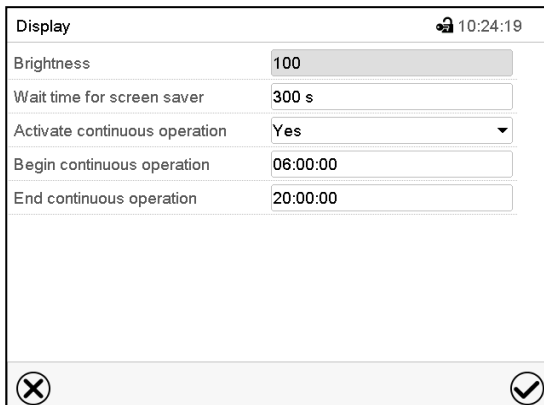

“Display” submenu.

- Select the field “Brightness”.
Move the grey slide to the left or right to define the brightness of the display
 - left = darker (minimum value: 0)
 - right = brighter (maximum value: 100)
- Press the **Confirm** icon.



- Select the field “Wait time for screen saver” and enter the desired waiting time for the screen saver in seconds. Setting range: 10 sec up to 32767 sec. During the waiting time the display is off. Confirm entry with **Confirm** icon.
- In the field “Activate continuous operation” select the desired setting “Yes” or “No”.

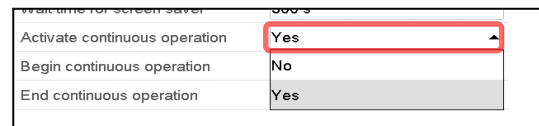

- Select the field “Begin continuous operation” (possible only if continuous operation is activated) and enter the time with the arrow keys. Confirm entry with **Confirm** icon.
- Select the field “End continuous operation. (only possible if continuous operation is activated) and enter the time with the arrow keys. Confirm entry with **Confirm** icon.

After completing the settings, press the **Confirm** icon to take over the entries and exit the menu, **or** press the **Close** icon to exit the menu without taking over the entries.

13.4.2 Touchscreen calibration

This function serves to optimize the display for the user’s individual angular perspective.

Path: [Main menu > Calibrate touchscreen](#)

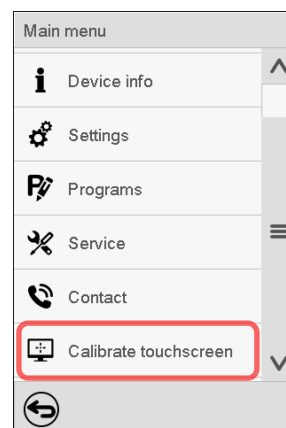
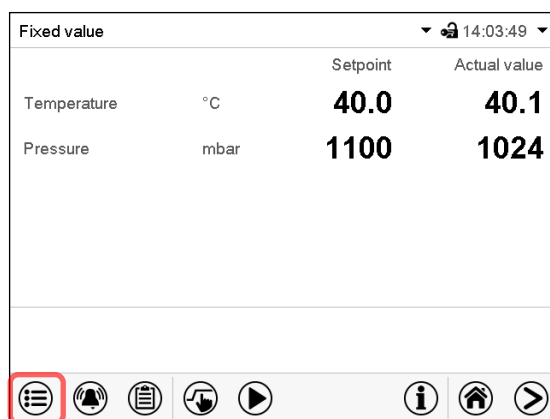

Normal display.

Select “Calibrate touchscreen” and follow the instructions on the display.

You need to touch all four corners of the touchscreen to calibrate it. Appropriate boxes appear successively in each corner.

| | |
|---|---|
|  | <p>The waiting icon shows how much time there is left to touch the currently activated box. If the box is not touched within this period, calibration is aborted and the display changes to Normal display.</p> |
|---|---|

After completing the calibration, i.e., touching all four boxes, the display changes to Normal display.

13.5 Event list

The “Event list” displays status information and errors of the current day. It enables to view the last 100 events or defective conditions of the chamber.

| | |
|---|---|
|  | <p>Press the Event list icon to access the event list from Normal display.</p> |
|---|---|

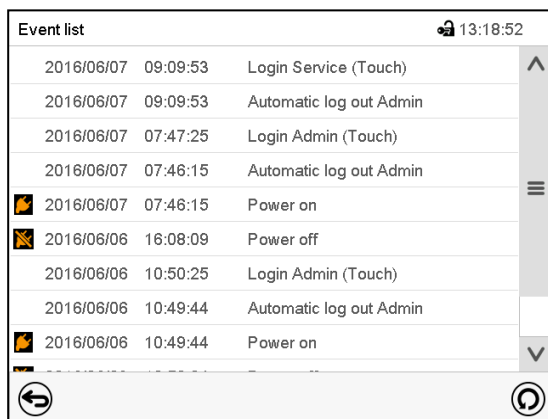

Event list

| | |
|---|---|
|  | <p>Press the Update icon to update the event list.</p> |
|---|---|

| | |
|---|--|
|  | <p>Attention: Following a modification of the language setting (chap. 13.1) or the storage interval of the chart recorder (chap. 22.2) the Event list is cleared.</p> |
|---|--|

13.6 Service contact page

Path: [Main menu](#) > [Contact](#)

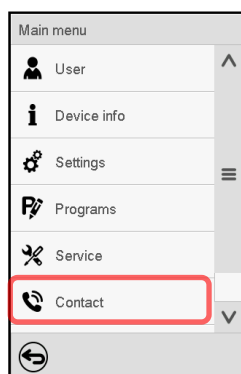

13.7 Current operating parameters

 Press the **Information** icon to access the “Info” menu from Normal display.

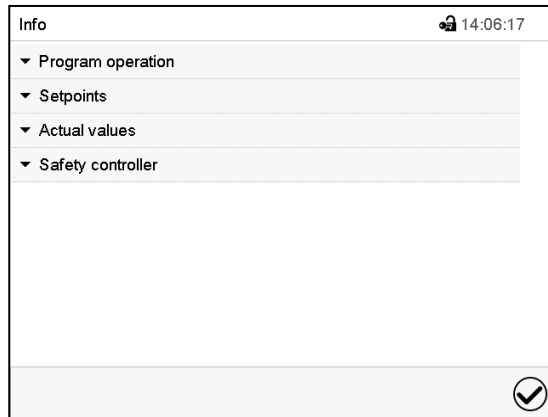

“Info” menu.
Select the desired information.

- Select “Program operation” to see information on a currently running program.
- Select “Setpoints” to see information on the entered setpoints and operation lines.
- Select “Actual values” to see information on the current actual values.
- Select “Safety controller” to see information on the safety controller status.

13.8 Technical chamber information

Path: [Main menu > Device info](#)

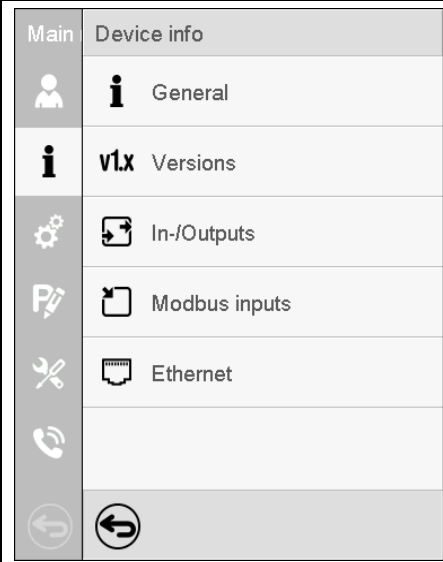
| | | |
|---|--|--------------------|
|  | Device info | |
| | Chamber name and setup | |
| | Versions of CPU, I/O module and safety controller | for BINDER Service |
| | Information on digital and analog inputs and outputs and phase angle outputs | for BINDER Service |
| | Information on modbus analog and digital inputs | for BINDER Service |
| | Information on Ethernet connection, MAC address display | chap. 20.1 |
| | Back to main menu | |

14. Temperature safety devices

14.1 Safety temperature limiter (TL) class 2

The safety temperature limiter (TL) serves to protect the vacuum drying oven, its environment and loading material against exceeding the permitted temperature. It has a fixed switching threshold and prevents exceeding the maximum surface temperature of the inner chamber of 160 °C in the event of a fault. If this temperature is exceeded, the heater turns off.

The safety temperature limiter (TL) provides temperature monitoring through a thermal switch (bimetal switch). If the permissible temperature is exceeded, the heating is switched off and an additional self-holding circuit is activated, which is only reset when the power plug is removed and reconnected. This prevents the heating from being automatically switched on again. When the TL is triggered, an alarm message is displayed on the controller. An annual function check by the operator is recommended, for this a controller test routine is provided (chap. 16.5).

The safety temperature limiter (TL) provides ignition source monitoring. For further information of its function as part of the manufacturer's safety plan, please refer to chap. 3.1.

14.2 Overtemperature safety controller class 2

The chambers are regularly equipped with an electronic overtemperature safety controller (temperature safety device class 2 – temperature limiter) acc. to DIN 12880:2007). The safety controller protects the chamber, its environment and the charging material against exceeding the maximum permissible temperature. The safety device class 2 is electrically independent of the temperature controller and turns off the chamber permanently.

In the event of a fault in the temperature controller, the safety controller turns off the vacuum drying oven permanently, i.e. until manual alarm reset. This condition (state of alarm) is indicated visually and additionally with an audible alert if the buzzer is enabled (chap. 16.4). You can turn off the buzzer with the **OK button / Confirm** icon. The alarm persists until the chamber cools down below the configured safety controller value.

Please observe the regulations applicable to your country (for Germany: DGUV guidelines 213-850 on safe working in laboratories, issued by the employers' liability insurance association).



Check the setting regularly and adjust it following changes of the set-point or charge.



The temperature safety device only activates after the set-point has been reached once.

14.2.1 Safety controller mode

You can set the **safety controller mode** to "Limit" or "Offset".

- **Limit:** Limit value, absolute maximum permitted temperature value

This setting offers high safety as a defined temperature limit will not be exceeded. It is important to adapt the safety controller value after each modification of the temperature set-point. Otherwise, the limit could be too high to ensure efficient protection, or, in the opposite case, it could prevent the controller from reaching an entered set-point outside the limit range.

- **Offset:** Offset value, maximum overtemperature above any active temperature set point. The resulting maximum temperature changes internally and automatically with every temperature set-point change.

This setting is recommended for program operation. It is important to check the safety controller set-point and safety controller mode occasionally, as it does not offer a fix, independent limit temperature value, which would never be exceeded.

The safety controller mode "Limit" offers greater safety also for programs when drying substances containing solvents.

Example:

Desired temperature value: 40 °C, desired safety controller value: 45 °C.

Possible settings for this example:

| Temperature set point | Safety controller mode | Safety controller value |
|-----------------------|------------------------|-------------------------|
| 40 °C | Limit | Limit value 45 °C |
| | Offset | Offset value 5 °C |

Recommended setting: Safety controller mode “Limit”, safety controller value by approx. 5 °C above the temperature set-point.

14.2.2 Setting the safety controller



Press the **Setpoint setting** icon to access the “Setpoint” setting menu from Normal display.

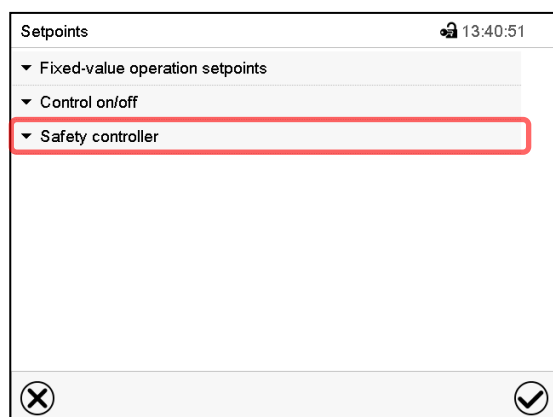

“Setpoints” menu.

Select the field “Safety controller” to access the settings.

- In the field “Mode” select the desired setting “Limit” or “Offset”.

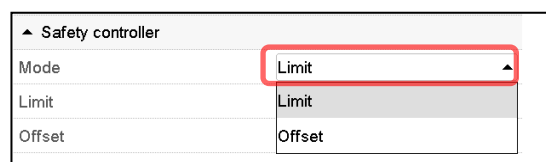

- Select the corresponding field “Limit” **or** “Offset” according to the selected mode and enter the desired safety controller setpoint. Confirm entry with **Confirm** icon.



Regularly check the safety controller setting for set-point type “Limit” or “Offset”

- in Fixed value operating mode according to the entered set-point temperature value
- in program mode according to the highest temperature value of the selected temperature program

Recommended setting: Set the safety controller set-point by approx. 5 °C above the desired temperature set-point.

After completing the settings, press the **Confirm** icon to take over the entries and exit the menu, **or** press the **Close** icon to exit the menu without taking over the entries.

14.2.3 Message and measures in the state of alarm

The state of alarm is indicated visually and additionally with an audible alert if the buzzer is enabled (chap. 16.4).

The alarm remains active until it is acknowledged on the controller and the inner temperature falls below the set safety controller setpoint. Then the heating is released again.

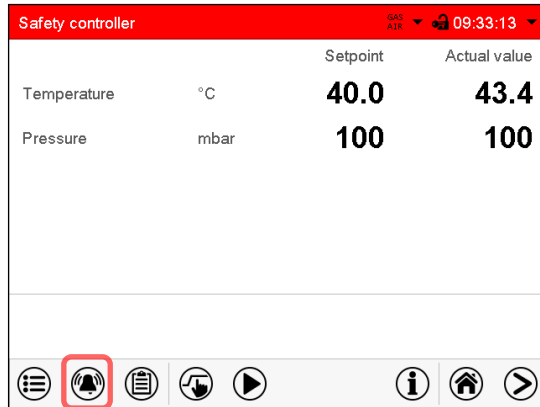

Normal display with safety controller alarm.
Press the **Alarm** icon

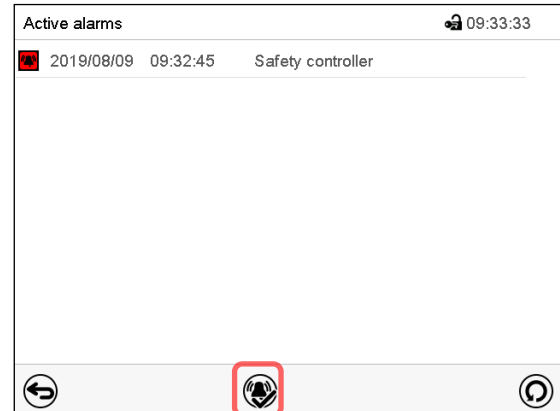

List of active alarms.
Press the **Reset alarm** icon.

14.2.4 Function check

Check the safety controller at appropriate intervals for its functionality. It is recommended that the authorized operating personnel should perform such a check, e.g., before starting a longer work procedure.

15. Tolerance range settings

In this menu you can define for temperature and pressure the deviation between the actual value and setpoint, which that shall cause a tolerance range alarm. The entered value defines the limit of permitted deviations from the set-point (exceeding and falling below). Reaching this limit triggers tolerance alarm.

In addition, you can specify delay times for these alarms.

This function only activates after the set-point has been reached once.

15.1 Setting the alarm delay times and the tolerance ranges

Path: [Main menu](#) > [Settings](#) > [Various](#)

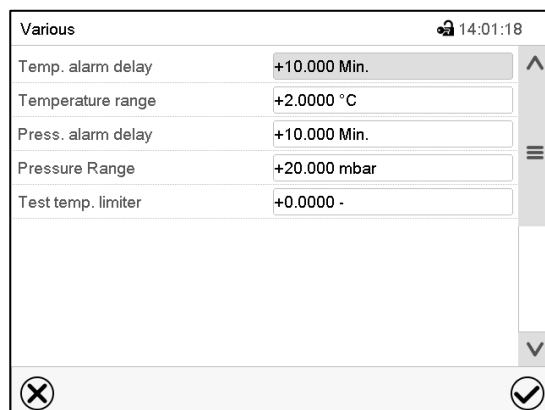

Submenu "Various".



- Select the field “**Temp. alarm delay**” and enter the time in minutes, after which the temperature range alarm shall be triggered. Setting range: 1 min to 120 min. Confirm entry with **Confirm** icon.
- Select the field “**Temperature range**” and enter the desired value for the temperature range. Setting range: 1,0 °C to 10,0 °C. Confirm entry with **Confirm** icon.
- Select the field “**Press. alarm delay**” and enter the time in minutes, after which the pressure range alarm shall be triggered. Setting range: 1 min to 120 min. Confirm entry with **Confirm** icon.
- Select the field “**Pressure range**” and enter the desired value for the pressure range. Setting range: 10 mbar to 200 mbar. Confirm entry with **Confirm** icon.

For testing the safety temperature limiter (TB) see chap. 16.5.

After completing the settings, press the **Confirm** icon to take over the entries and exit the menu, **or** press the **Close** icon to exit the menu without taking over the entries.

15.1.1 Alarm condition

If there are actual values outside the tolerance range the following information icons for the corresponding parameter are displayed:

| Icon | Signification | Information |
|--|---------------------|---|
|  | “Temperature range” | The current actual temperature value is outside the tolerance range |
|  | “Pressure range” | The current actual pressure value is outside the tolerance range |

If the condition persists, an alarm is triggered after the configured interval (“range alarm delay”). It is visually indicated in Normal display. If the alarm buzzer is activated (chap. 16.4) there is an audible alert. The alarm is shown in the list of active alarms (chap. 16.3).

16. Notification and alarm functions

16.1 Information messages

Information messages are indicated by **information icons** displayed in the screen header in Normal display.

An information icon serves as an indication of a certain condition.

If this condition persists, in some cases an alarm will be triggered after a fix or configurable interval. As long as the condition persists, the information icon therefore continues to be displayed also in state of alarm. If during alarm the conditions ends, e.g., if during a tolerance range alarm the actual value returns to within the tolerance range, the information icon disappears, whereas the alarm will continue until manual acknowledgement.



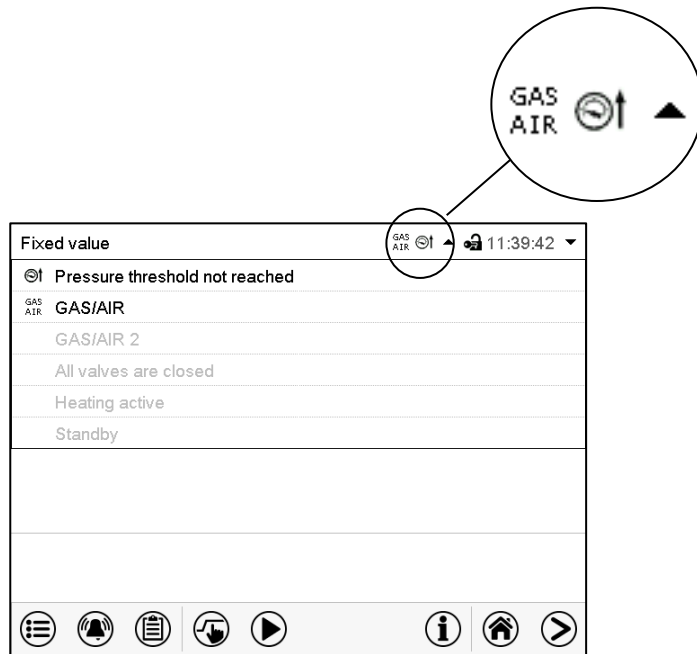

Press the flash icon next to the information icon to access the corresponding text information.



Normal display showing the text information.

The currently valid information texts are highlighted in black (example: "Pressure threshold not reached" and "GAS/AIR")

Information messages overview:

| Condition | Information icon | Text information | Start after condition occurred |
|--|---|--|--------------------------------|
| Deactivated temperature control | | Temperature setpoint value display shows " _ _ _ _ " | immediately |
| Deactivated pressure control | | Pressure setpoint value display shows " _ _ _ _ " | immediately |
| Pressure threshold of 100 mbar not reached |  | "Pressure threshold not reached" | immediately |
| Ventilation via regular connection "GAS/AIR" (4) | GAS AIR | "GAS/AIR" | immediately |
| Ventilation via optional connection "GAS/AIR 2" (5). Regular connection "GAS/AIR" (4) deactivated. | GAS AIR2 | "GAS/AIR 2" | immediately |
| All valves are closed |  | "All valves are closed" | immediately |
| Chamber is heating up |  | "Heating active" | immediately |
| Standby mode activated |  | "Standby" | immediately |

Information messages are not shown in the event list.

16.2 Alarm messages

Alarm messages overview:

| Condition | Alarm message | Start after condition occurred |
|--|--|---|
| The current actual temperature value is outside the tolerance range (chap. 15) | "Temperature range" | after configurable time (chap. 15.1) Factory setting: 10 minutes |
| The current actual pressure value is outside the tolerance range (chap. 15) | "Pressure range" | after configurable time (chap. 15.1) Factory setting: 10 minutes |
| Safety temperature limiter (TL) has turned off the heater | "Overtemperature" | immediately |
| Exceeded setpoint of the safety controller class 2 | "Safety controller" | immediately |
| Inner chamber temperature sensor defective. Heater turns off. | Actual temperature value display shows e.g. "----" or "<-<-<" or ">->->" | immediately |
| Heater temperature sensor defective. Heater turns off. | "Heater temp.sensor" | immediately |
| Pressure sensor defective | Actual pressure value display shows e.g. "----" or "<-<-<" or ">->->" | immediately |
| Failure of temperature sensor for object temperature (option) | Object pressure value display shows e.g. "----" or "<-<-<" or ">->->" | immediately |

Alarm messages are displayed in the list of active alarms until acknowledging them. They are also shown in the event list.

State of alarm

1. Visual indications in Normal display: alarm message, screen header flashing in red color
2. Audible alert, if the buzzer is enabled (chap. 16.4).

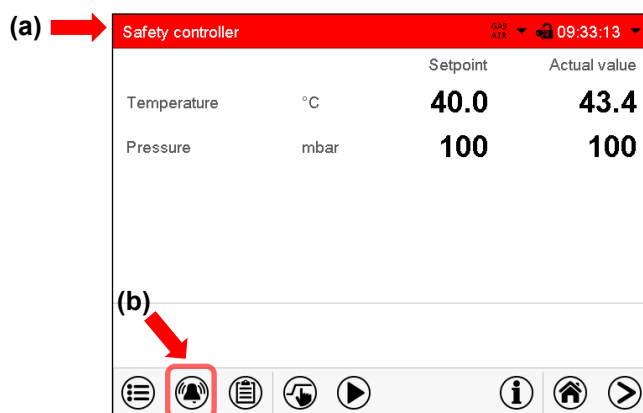

Normal display in state of alarm (example).

(a) Screen header flashing in red color and showing the alarm message

(b) **Alarm** icon on the bottom of the screen: change to the list of active alarms and alarm acknowledgement

16.3 Resetting an alarm

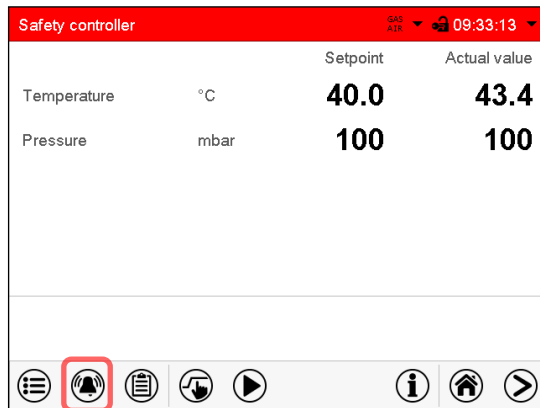

Normal display in state of alarm (example).
Press the **Alarm** icon.

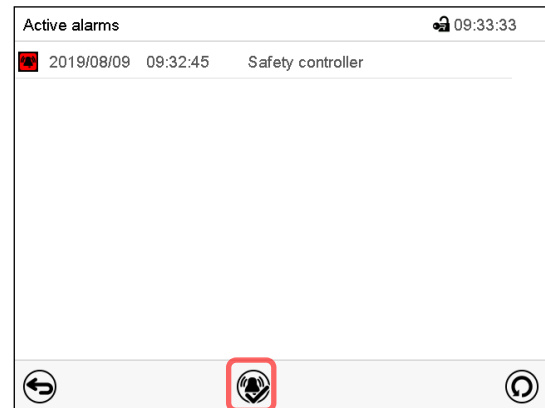

List of active alarms.
Press the **Reset alarm** icon.

Pressing the **Reset alarm** icon mutes the buzzer for all active alarms. The icon then disappears.

- Acknowledging while the alarm condition persists: Only the buzzer turns off. The visual alarm indication remains on the controller display. The alarm remains in the list of active alarms.

When the alarm condition has ended, the visual alarm indication is automatically cleared. The alarm is then no longer in the list of active alarms.

- Acknowledging after the alarm condition has ended: The buzzer and the visual alarm indication are reset together. The alarm is then no longer in the list of active alarms.

16.4 Activating / deactivating the audible alarm (buzzer)

Path: [Main menu](#) > [Settings](#) > [Chamber](#)

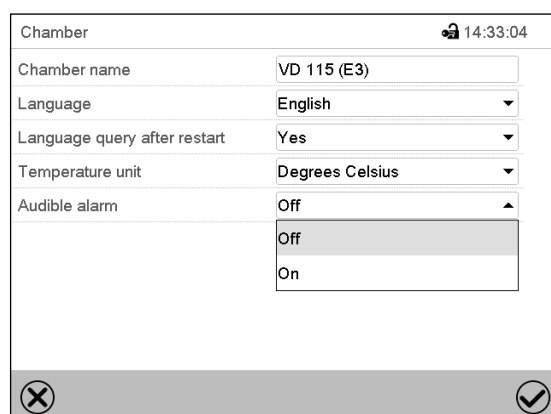

“Chamber” submenu (example).

In the field “Audible alarm” select the desired setting “off” or “on” and press the **Confirm** icon.

16.5 Test alarm of the safety temperature limiter (TL)

The safety temperature limiter (TL) provides temperature monitoring with a fixed switching threshold. It is an essential element of the manufacturer's safety plan to prevent ignition and explosions (chap. 3.1). Therefore, an annual function check by the operator is recommended. To do this, you can use the controller test routine described following. The test is performed on an empty chamber (without vacuum expansion racks and rack holders).

If the ambient temperature is below 28 °C, the chamber must be heated up to 28 °C to 38 °C before starting the test. To activate the heating, the chamber must first be evacuated below 100 mbar. This negative pressure is maintained during the test.

For chambers equipped with a single safety temperature limiter (TL), this is tested with the setting "1". For chambers with 2 TB, the test is run twice, first with the setting "1" and then again with the setting "2".

| Chambers with one TL | Chambers with two TL |
|--------------------------------|-----------------------------------|
| VDL 23 VDL 23-UL VDL 115 | VDL 56 VDL 56-UL VDL 115-UL |

Path: [Main menu](#) > [Settings](#) > [Various](#)

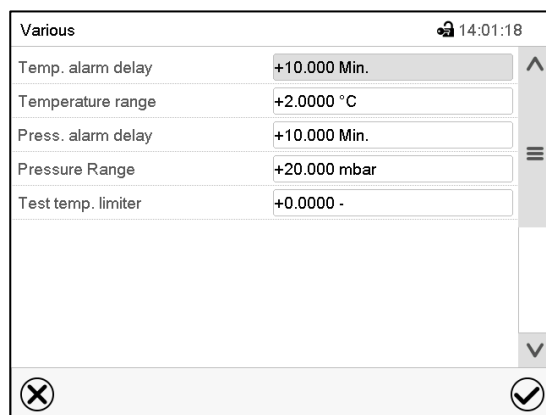

Submenu "Various".

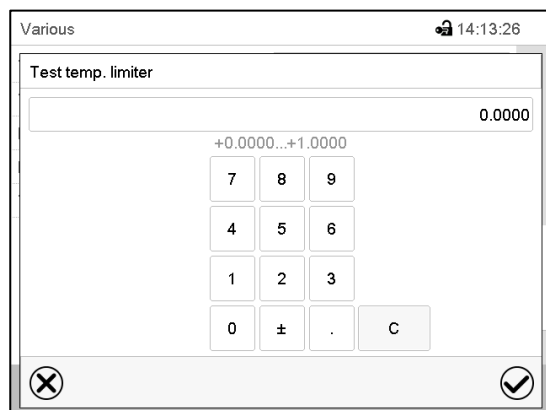

"Test temp. limiter" setting menu.

To activate the test alarm for the first TL, enter "1" and press the **Confirm** icon.

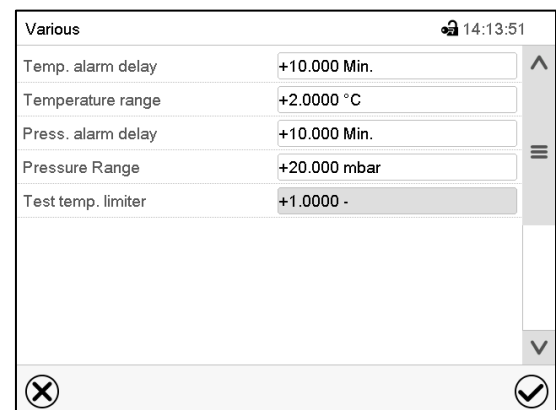

Submenu "Various" with activated test alarm "1".

Press the **Confirm** icon and go back to Normal display.

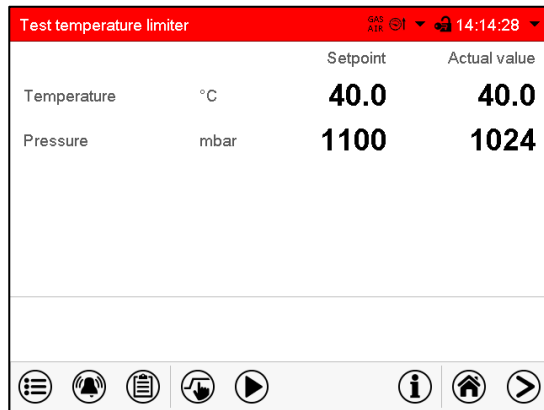

Normal display in state of alarm (sample values)

The alarm message “Test temperature limiter” Screen header flashes in red color. If the buzzer is enabled there is an audible alert. Press the **Alarm** icon.



List of active alarms.

Press the **Reset alarm** icon.

The chamber only starts heating if the current actual value of the unit has reached at least once a value below 40 °C. The chamber continues heating until one of the following alarm messages appears:

- If the test is passed, the alarm message “Temperature limiter 1 triggered” will be displayed.
- If the test fails, the alarm message “Temperature limiter 1 error” is displayed.

To deactivate the test alarm, go back to the “Test temp. limiter” setting menu and set the value to “0” (test alarm deactivated).

Then pull out the power plug and let the chamber cool down for 30 minutes. Plug in the power plug again to return to normal chamber operation.

For the chambers with a single safety temperature limiter (TL), the test is completed here.

For the chambers with two safety temperature limiters (TL), carry out another test for the second TL. For this purpose, the inner temperature must have cooled down to a value between 28 °C and 38 °C after the first test.

Enter “2” in the “Test temp. limiter” setting menu to activate the test alarm for the second TL and press the **Confirm** icon. Then proceed as described above.

The following table gives an overview of the maximum trigger times of the different chamber models.

If the safety temperature limiter is triggered before the end of this maximum trigger time, the test is considered passed. This corresponds to the alarm message “Temperature limiter 1 triggered” or “Temperature limiter 2 triggered”.



After the maximum trigger time has expired, the test is considered as failed. This corresponds to the alarm message “Temperature limiter 1 error” or “Temperature limiter 2 error”.

| Chamber | Test | Maximum trigger time in minutes |
|-------------------|------|---------------------------------|
| VDL 23, VDL 23-UL | 1 | 16 |
| VDL 56, VDL 56-UL | 1 | 20 |
| | 2 | 55 |
| VDL 115 | 1 | 17 |
| VDL 115-UL | 1 | 17 |
| | 2 | 22 |

17. Timer program (stopwatch function)



During an entered duration the controller constantly equilibrates to the setpoints entered in Fixed value operation mode (temperature, pressure, configuration of the special controller functions). This duration can be entered as a “Timer program”. During the program runtime, any setpoint changes do not become effective; the controller equilibrates to the values which were active during program start.

Solvents and forming vapors can ignite if the drying temperature is too high

| | |
|---|---|
|  |  DANGER |
| <p>Fire and explosion hazard when exceeding the auto-ignition temperature of the solvent due to excess drying temperature.</p> <p>Serious injury or death from burns and / or explosion pressure.</p> <p>➤ Make sure that only solvents with an auto-ignition temperature that is higher than 200 °C / 392 °F may be entered into the chamber. Check the auto-ignition temperature with the safety specifications of the solvent. In the case of solvent mixtures, use the auto-ignition temperature of the material with the lowest auto-ignition temperature.</p> | |









17.1 Starting a timer program

| | |
|---|--|
|  | <p>In Normal display press the Program start icon to access the “Program start” menu.</p> |
|---|--|

| | |
|---|---|
| Program start 🔒 07:37:40 | |
| Program type | Timer program  |
| Program | Time program |
| Start section | Week program |
| Program duration | Timer program |
| Program start | 2016/06/03 07:34:10 |
| Program end | 2016/06/03 07:34:10 |
| Programmhinweis | |
| Program info | |
|  |  |

“Program start” menu

- In the field “Program type” select “Timer program”.
- Select the field “Program duration” and enter the desired program duration. Press the **Confirm** icon.
- Select the field “Program start” and enter the desired start time of the program in the “Program start” entry menu. Press the **Confirm** icon. The program delay time until program start begins.

| | | | | | | |
|---|---------------|-----------------|-----------------|---|--|----------|
| <table style="width: 100%; border-collapse: collapse;"> <tr> <td style="border-bottom: 1px solid red;">Program</td> <td style="border-bottom: 1px solid red;">Timerprogramm</td> <td style="border-bottom: 1px solid red; text-align: right;">Program runtime</td> </tr> <tr> <td style="border-bottom: 1px solid red;"><div style="width: 50%; height: 10px; background-color: grey;"></div></td> <td style="border-bottom: 1px solid red;"></td> <td style="border-bottom: 1px solid red; text-align: right;">00:00:40</td> </tr> </table> | Program | Timerprogramm | Program runtime | <div style="width: 50%; height: 10px; background-color: grey;"></div> | | 00:00:40 |
| Program | Timerprogramm | Program runtime | | | | |
| <div style="width: 50%; height: 10px; background-color: grey;"></div> | | 00:00:40 | | | | |
|          | | | | | | |

Normal display.

Information on the bottom of the screen indicates the currently running program and the time already passed. The grey bar shows how much time of the whole time is elapsed.

17.1.1 Performance during program delay time

During the configured program delay time until program start, the controller equilibrates to the current setpoints of Fixed value operation mode. Modifications of these setpoints are possible but become effective only after the timer program is finished. When the configured moment for program start is reached, the program delay time ends and the program starts running. The controller equilibrates to the values which had been active during program start.



17.2 Stopping a running timer program

17.2.1 Pausing a running timer program

| | |
|---|---|
|  | Press the Program pause icon to interrupt the program. |
|---|---|

The program is paused. The program runtime stops running down, the time display flashes.

There are the following options:

| | |
|---|---|
|  | Press the Program start icon to continue the program |
|  | Press the Cancelling icon to cancel the program |

17.2.2 Cancelling a running timer program

| | |
|---|---|
|  | Press the Program cancelling icon to cancel the program. |
|---|---|

A confirmation prompt is displayed. Press the **Confirm** icon to confirm that the program shall really be cancelled.

After confirming the message the controller changes to Fixed value operation mode. Temperature and humidity will then equilibrate to the setpoints of Fixed value operation mode.

17.3 Performance after the end of the program

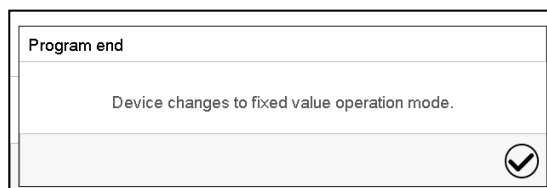

After the end of the program the message “Device changes to fixed value operation mode” appears on the screen.

Press the **Confirm** icon.

After confirming the message the controller changes to Fixed value operation mode. Temperature and humidity will then equilibrate to the setpoints of Fixed value operation mode.

18. Time programs



The MB2 program controller permits programming time programs with real-time reference. It offers 25 program memory positions with up to 100 program sections each.

For each program section you can enter a temperature set-point, a pressure set-point, section duration, type of temperature and pressure transition (ramp or step), the switching states of the special controller functions and the tolerance ranges.



Before starting the program, check the set-points entered in fixed value mode. After the end of the program, the set-points will equilibrate to these values

Solvents and forming vapors can ignite if the drying temperature is too high.

| | |
|---|---|
|  |  DANGER |
| <p>Fire and explosion hazard when exceeding the auto-ignition temperature of the solvent due to excess drying temperature.</p> <p>Serious injury or death from burns and / or explosion pressure.</p> <p>➤ Make sure that only solvents with an auto-ignition temperature that is higher than 200 °C / 392 °F may be entered into the chamber. Check the auto-ignition temperature with the safety specifications of the solvent. In the case of solvent mixtures, use the auto-ignition temperature of the material with the lowest auto-ignition temperature.</p> | |



Programming remains saved in case of a power failure or after turning off the unit.

Path: [Main menu](#) > [Programs](#) > [Time program](#)

18.1 Starting an existing time program



In Normal display press the **Program start** icon to access the “Program start” menu.

| | |
|---|---|
| Program start 🔒 10:17:27 | |
| Program type | Time program |
| Program | Drying monitoring |
| Start section | |
| Program duration | |
| Program start | 2019/09/23 10:17:23 |
| Program end | 2019/09/27 13:17:23 |
| Program info | Before start: set the correct temperatur setpoint in manual mode |
|  |  |

“Program start” menu

- In the field “Program type” select the setting “Time program”.
- In the field “Program” select the desired program.
- Select the field “Program start” and enter the desired program start time in the “Program start” entry menu. Press the **Confirm** icon. The program delay time until program start begins.

The program end is adapted automatically depending on the entered program duration.

After completing the settings, press the **Confirm** icon to take over the entries and exit the menu. The program starts running.

If instead you press the **Close** icon to exit the menu without taking over the entries, the program will not start.



Normal display. Information on the bottom of the screen indicates the currently running program and the time already passed. The grey bar shows how much time of the whole time is elapsed. If program duration has been set to infinite, the grey bar is not displayed.

Heating takes place only when a vacuum according to the pressure threshold of 100 mbar is reached. Only then start the program or set a tolerance range for the first program section.

18.1.1 Performance during program delay time

During the configured program delay time until program start, the controller equilibrates to the current setpoints of Fixed value operation mode. Modifications of these setpoints are effective. When the configured moment for program start is reached, the program delay time ends and the program starts running.

18.2 Stopping a running time program

18.2.1 Pausing a running time program

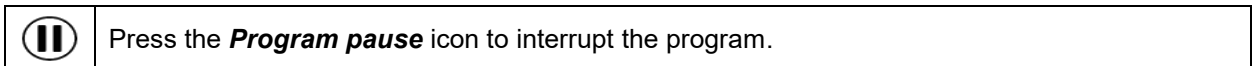

The program is paused. The program runtime stops running down, the time display flashes.

There are the following options:

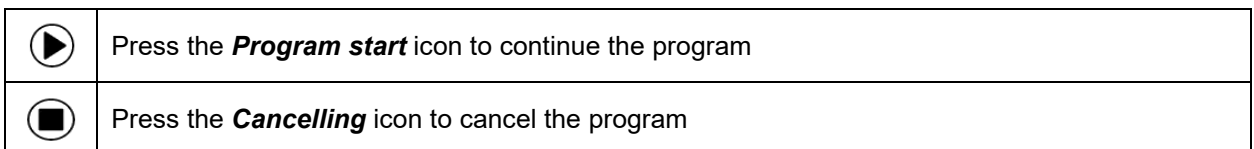

18.2.2 Cancelling a running time program

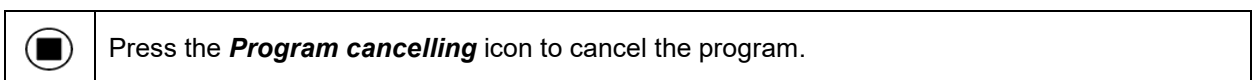

A confirmation prompt is displayed. Press the **Confirm** icon to confirm that the program shall really be cancelled.

After confirming the message, the controller changes to Fixed value operation mode. Temperature and humidity will then equilibrate to the setpoints of Fixed value operation mode.

18.3 Performance after the end of the program

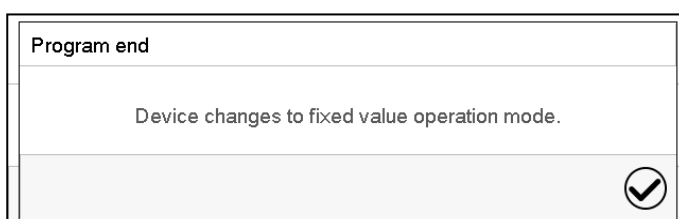

After the end of the program the message "Device changes to fixed value operation mode" appears on the screen.

Press the **Confirm** icon.

As long as the message has not been confirmed, the setpoint of the last program section remains effective. Program the last section as desired. If e.g. temperature and pressure control shall turn off, activate the corresponding controller functions (chap. 11.4, 11.5).

After confirming the message, the controller changes to Fixed value operation mode. Temperature and humidity will then equilibrate to the setpoints of Fixed value operation mode.

18.4 Creating a new time program

Path: [Main menu](#) > [Programs](#) > [Time program](#)

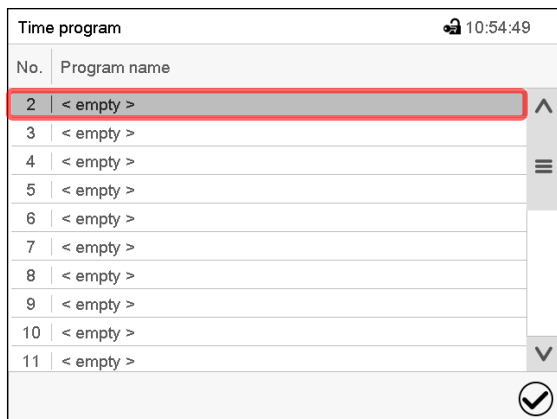

“Time program” menu:
overview of the existing programs.
Select an empty program place.

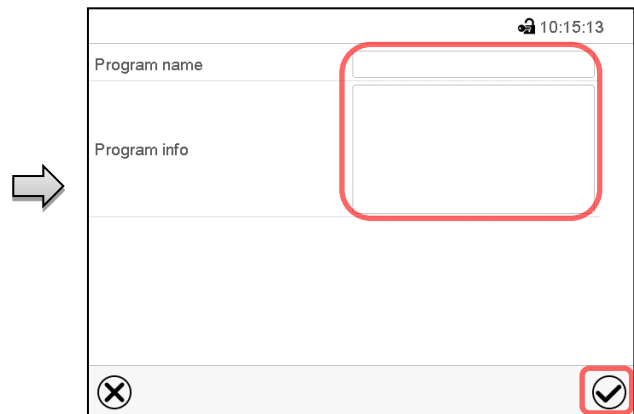

Enter the program name and, if desired, additional program information in the corresponding fields.

Press the **Confirm** icon.

The program view opens (chap. 18.5).

18.5 Program editor: program management

Path: [Main menu](#) > [Programs](#) > [Time program](#)

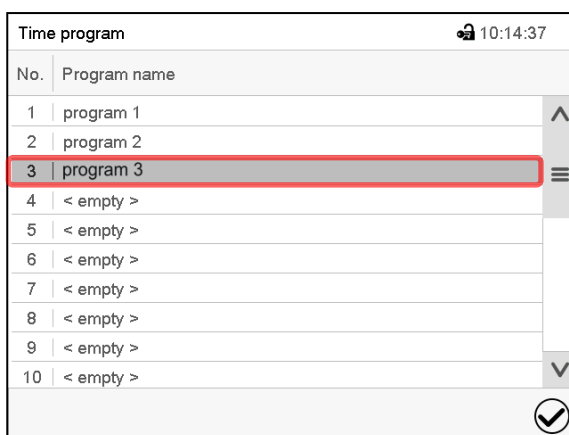

“Time program” menu:
overview of the existing programs.
Select an existing program (example: program 3) or create a new program (chap. 18.4).
The program view opens.

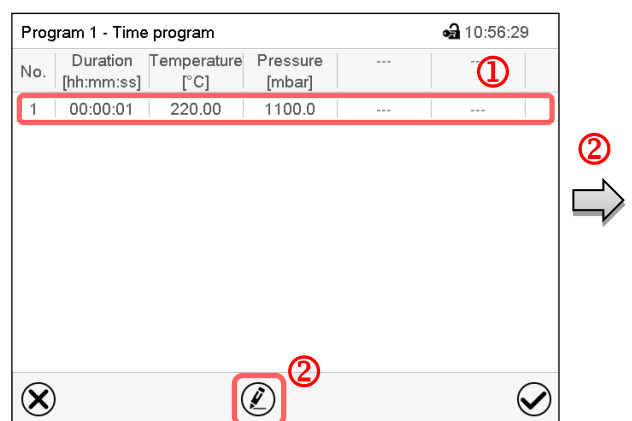

Program view (example: program 3).

If a new program has been created, there is just one program section.

There are the following options:

- ① Select a program section to open the section editor (chap. 18.6)
- ② Press the **Edit** icon to open the program editor

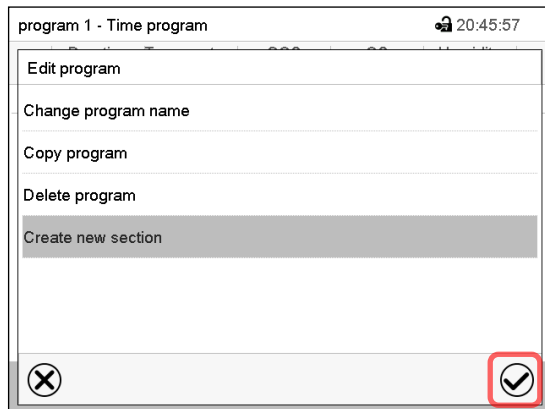

Program editor: "Edit program" menu

Select the desired function and press the **Confirm** icon.

The program editor offers following options:

- Change the program name
- Copy program
- Replace program: Replacing a new or an existing program with the copied program. This menu point is visible only after a program has been copied.
- Delete program
- Create new section

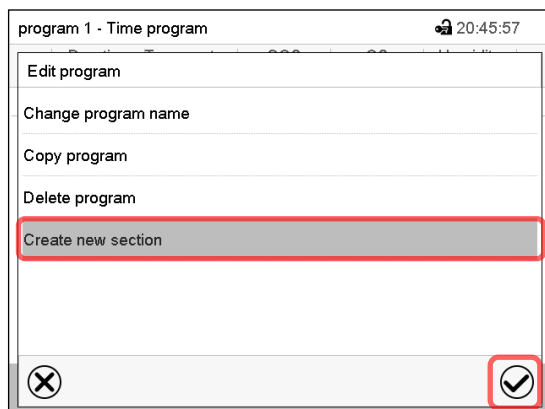

To add a new section, select "Create new section" and press the **Confirm** icon.

The program view opens.

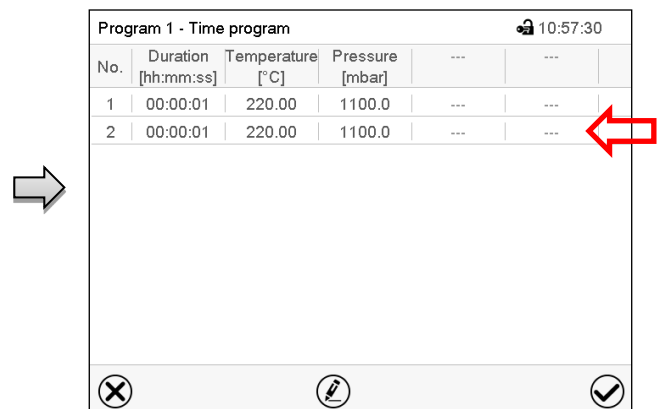

Program view.

A new section is always added at the very bottom (example: section 2).

18.5.1 Deleting a time program

Path: [Main menu](#) > [Programs](#) > [Time program](#)

In the "Time program" menu select the program to be deleted. The program view opens.



In the **program view** press the **Edit** icon to open the program editor



In the **program editor** select "Delete program" and press the **Confirm** icon.

The program is deleted. The controller returns to the program view.

18.6 Section editor: section management

Path: **Main menu > Programs > Time program**

Select the desired program.

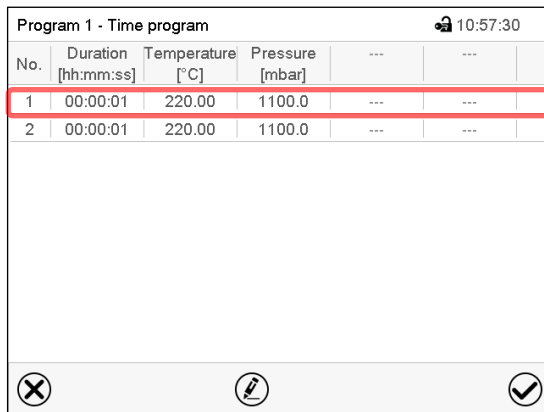

| No. | Duration [hh:mm:ss] | Temperature [°C] | Pressure [mbar] | --- | --- |
|-----|------------------------|---------------------|--------------------|-----|-----|
| 1 | 00:00:01 | 220.00 | 1100.0 | --- | --- |
| 2 | 00:00:01 | 220.00 | 1100.0 | --- | --- |

Program view.

Select the desired program section
(example: section 1)

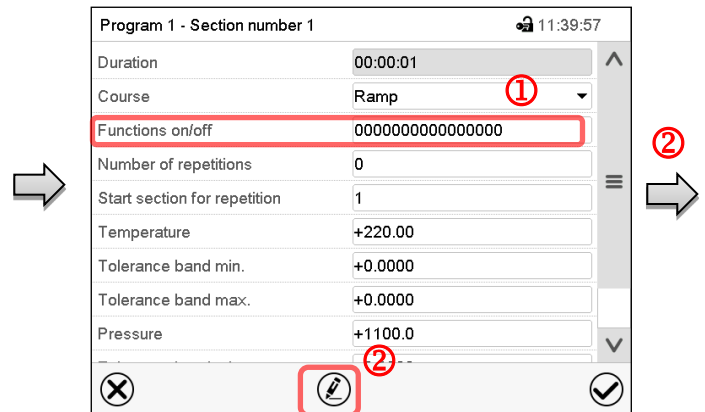

Program 1 - Section number 1

Duration: 00:00:01

Course: Ramp

Functions on/off: 0000000000000000

Number of repetitions: 0

Start section for repetition: 1

Temperature: +220.00

Tolerance band min.: +0.0000

Tolerance band max.: +0.0000

Pressure: +1100.0

Section view (example: section 1).

There are the following options:

- ① Select a parameter to enter or modify the according value (chap. 18.7)
- ② Press the **Edit** icon to open the program editor

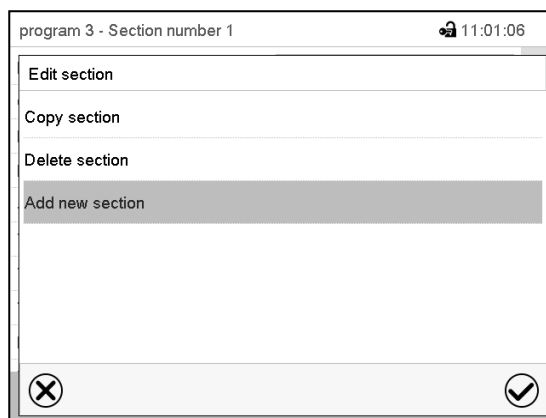

program 3 - Section number 1

Edit section

Copy section

Delete section

Add new section

Section editor: "Edit section" menu

Select the desired function and press the **Confirm** icon.

The section editor offers following options:

- Copy section
- Replace section: Replacing an existing section with the copied section. This menu point is visible only after a section has been copied.
- Insert section: Adding the copied section. This menu point is visible only after a section has been copied.
- Delete section
- Add new section

18.6.1 Add a new program section

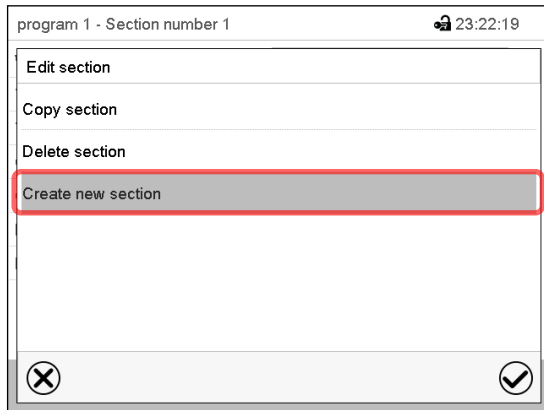

Section editor: "Edit section" menu.

Select "Create new section" and press the **Confirm** icon.

Then select whether to insert the new section before or after the current section.

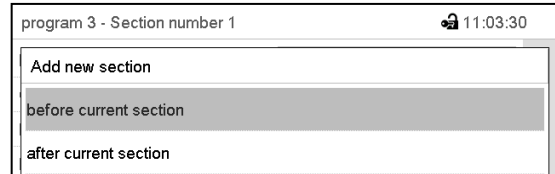

Press the **Confirm** icon. The new section opens.

18.6.2 Copy and insert or replace a program section

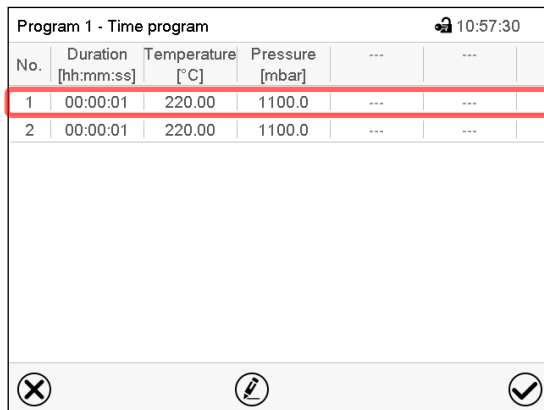

Program view.

Select the program section to be copied (example: section 1)

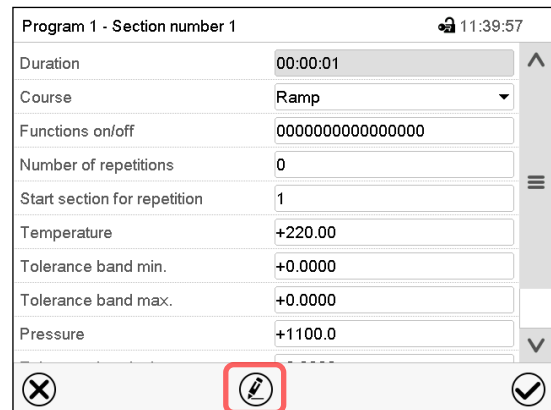

Section view (example: section 1).

Press the **Edit** icon to open the section editor.

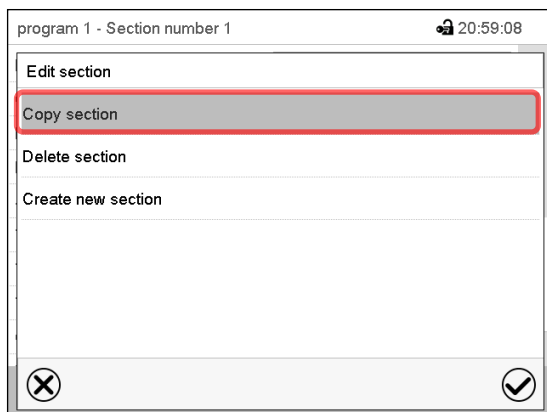

Section editor: "Edit section" menu

Select "Copy section" and press the **Confirm** icon.

The current section (example: section 1) is copied. The controller returns to the section view.

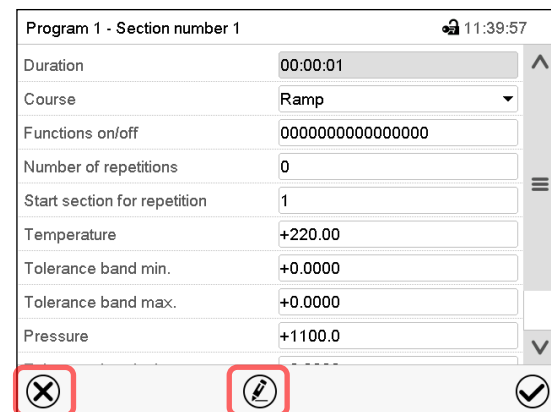

Section view (example: section 1).

Press the **Close** icon to change to the program view, if you want to select another section to be replaced or before or after which the copied section shall be inserted...



or

Press the **Edit** icon to open the section editor if you want the current section to be replaced or the copied section to be inserted before or after it

Program 1 - Time program 10:57:30

| No. | Duration [hh:mm:ss] | Temperature [°C] | Pressure [mbar] | --- | --- |
|-----|---------------------|------------------|-----------------|-----|-----|
| 1 | 00:00:01 | 220.00 | 1100.0 | --- | --- |
| 2 | 00:00:01 | 220.00 | 1100.0 | --- | --- |

Navigation icons: Close (X), Edit (Pencil), Confirm (Checkmark)

Program view.

Select the section to be replaced or before or after which the copied section shall be inserted (example: section 2) and press the **Confirm** icon.

Program 1 - Section number 1 11:39:57

Duration: 00:00:01

Course: Ramp

Functions on/off: 0000000000000000

Number of repetitions: 0

Start section for repetition: 1

Temperature: +220.00

Tolerance band min.: +0.0000

Tolerance band max.: +0.0000

Pressure: +1100.0

Navigation icons: Close (X), Edit (Pencil), Confirm (Checkmark)

Section view (example: section 1).

Press the **Edit** icon to open the section editor

Program 1 - Section number 1 11:48:00

Edit section

Copy section

Replace section

Insert section

Delete section

Create new section

Navigation icons: Close (X), Confirm (Checkmark)

Section editor: "Edit section" menu

Select "Replace section" to replace the selected section with the copied section

or

Select "Insert section" to additionally add the copied section.

In this case select whether to insert it before or after the selected section.

Insert section

before current section

after current section

Press the **Confirm** icon

18.6.3 Deleting a program section

In the **program view** select the program section to be deleted. The section view opens.

➔ In the **section view** press the **Edit** icon to open the section editor

➔ In the **section editor** select "Delete section" and press the **Confirm** icon.
The section is deleted. The controller returns to the section view.

18.7 Value entry for a program section

Path: **Main menu > Programs > Time program**

Select the desired program and section.

The section view gives access to all parameters of a program section. You can enter or modify the values.

| <div style="border: 1px solid black; padding: 5px;"> <p>Program 1 - Section number 1 🔒 11:39:57</p> <p>Duration <input type="text" value="00:00:01"/> ^</p> <p>Course <input type="text" value="Ramp"/> v</p> <p>Functions on/off <input type="text" value="0000000000000000"/></p> <p>Number of repetitions <input type="text" value="0"/></p> <p>Start section for repetition <input type="text" value="1"/></p> <p>Temperature <input type="text" value="+220.00"/></p> <p>Tolerance band min. <input type="text" value="+0.0000"/></p> <p>Tolerance band max. <input type="text" value="+0.0000"/></p> <hr/> <p>Pressure <input type="text" value="+1100.0"/></p> <p>Tolerance band min. <input type="text" value="+0.0000"/></p> <p>Tolerance band max. <input type="text" value="+0.0000"/></p> <p style="text-align: center;">⊗ ⊙</p> </div> | <table border="1" style="width: 100%; border-collapse: collapse;"> <tr style="background-color: #cccccc;"> <th style="padding: 5px;">Program name and section number</th> </tr> <tr> <td style="padding: 5px;">Section duration</td> </tr> <tr> <td style="padding: 5px;">Type of setpoint transition: ramp or step</td> </tr> <tr> <td style="padding: 5px;">Special controller function</td> </tr> <tr> <td style="padding: 5px;">Repeating one or several sections within a program</td> </tr> <tr> <td style="padding: 5px;">Temperature setpoint</td> </tr> <tr> <td style="padding: 5px;">Temperature tolerance range: minimum and maximum</td> </tr> <tr> <td style="padding: 5px;">Pressure setpoint</td> </tr> <tr> <td style="padding: 5px;">Pressure tolerance range: minimum and maximum</td> </tr> <tr> <td style="padding: 5px;"> </td> </tr> </table> | Program name and section number | Section duration | Type of setpoint transition: ramp or step | Special controller function | Repeating one or several sections within a program | Temperature setpoint | Temperature tolerance range: minimum and maximum | Pressure setpoint | Pressure tolerance range: minimum and maximum | |
|---|--|---------------------------------|------------------|---|-----------------------------|--|----------------------|--|-------------------|---|--|
| Program name and section number | | | | | | | | | | | |
| Section duration | | | | | | | | | | | |
| Type of setpoint transition: ramp or step | | | | | | | | | | | |
| Special controller function | | | | | | | | | | | |
| Repeating one or several sections within a program | | | | | | | | | | | |
| Temperature setpoint | | | | | | | | | | | |
| Temperature tolerance range: minimum and maximum | | | | | | | | | | | |
| Pressure setpoint | | | | | | | | | | | |
| Pressure tolerance range: minimum and maximum | | | | | | | | | | | |
| | | | | | | | | | | | |

The setting and control ranges for the individual parameters are the same as for “Fixed value” operating mode.

18.7.1 Section duration

program 3 - Section number 1 🔒 10:58:07

Duration ^

Section view (partial view).

Select the field “Duration” indicating the time.

program 3 - Section number 2 🔒 11:14:19

Duration

| | | |
|----|---|----|
| ^ | ^ | ^ |
| 00 | : | 00 |
| ∨ | : | 01 |
| ∨ | : | ∨ |

(hh:mm:ss)

⊗

“Duration” entry menu.

Enter the desired section duration with the arrow keys and press the **Confirm** icon.

Setting range: 0 up to 99 hours 59 min 59 sec.

18.7.2 Set-point ramp and set-point step

You can define the type of temperature and pressure transitions for each individual program section.

“Ramp” mode: Gradual changes of temperature and pressure

The set-point of a given program section functions as the section’s start temperature. During the section’s duration, the set-point gradually passes to the set-point of the subsequent program section. The actual value follows the continually changing set-point.

If the last program section is in “ramp” mode and the setpoint shall change within this section, then you must program an additional section (with the shortest possible section duration) to provide the target temperature of the last program section. Otherwise, the setpoint would remain constant during the section’s duration.

Programming in the “ramp” mode allows all kinds of temperature and humidity transitions:

- Gradual changes of temperature and pressure
The setpoint changes its value gradually during the entered section duration. The actual value follows the continually moving set-point at any time.
- Program sections with constant temperature and pressure
The setpoints (initial values) of two subsequent program sections are identical; so, the temperature and pressure remain constant during the entire duration of the first program section.
- Sudden changes of temperature and pressure
Steps can be programmed in ramp mode as temperature or humidity changes (ramps) that occur during a very short interval. If the duration of this transitional program section is very short (minimum entry 1 sec), the temperature or humidity change will proceed rapidly within the minimum amount of time.

“Step” mode: Sudden changes of temperature and pressure

The set-point of any program section functions as the section’s target value. At the start of the program section, the unit heats up and evacuates / ventilates the chamber with the maximum speed to reach the entered value; and then it holds it for the remaining section time. Therefore, the set-point temperature remains constant for the section’s duration. These changes occur rapidly within the minimum amount of time (minimum entry: 1 second).

Programming in the “step” mode allows only two kinds of temperature and pressure transitions:

- Programming gradual changes of temperature and humidity (ramps) is impossible in the “step” mode
- Program sections with constant temperature and pressure
The setpoints (target values) of two subsequent program sections are identical; so, the temperature and pressure remain constant during the entire duration of the first program section.
- Sudden changes of temperature and pressure
The entered setpoint of the section is reached as fast as possible and then held constant for the remaining section duration.

Selecting the setting “Ramp” or “Step”

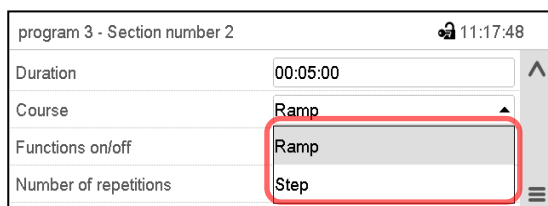

| program 3 - Section number 2 | | 🔒 11:17:48 |
|------------------------------|----------|------------|
| Duration | 00:05:00 | ▲ |
| Course | Ramp | ▲ |
| Functions on/off | Ramp | |
| Number of repetitions | Step | ☰ |

Section view (partial view).

In the field “Course” select the desired setting “Ramp” or “Step”.

“Ramp” and “Step” mode example (representation of a temperature course)

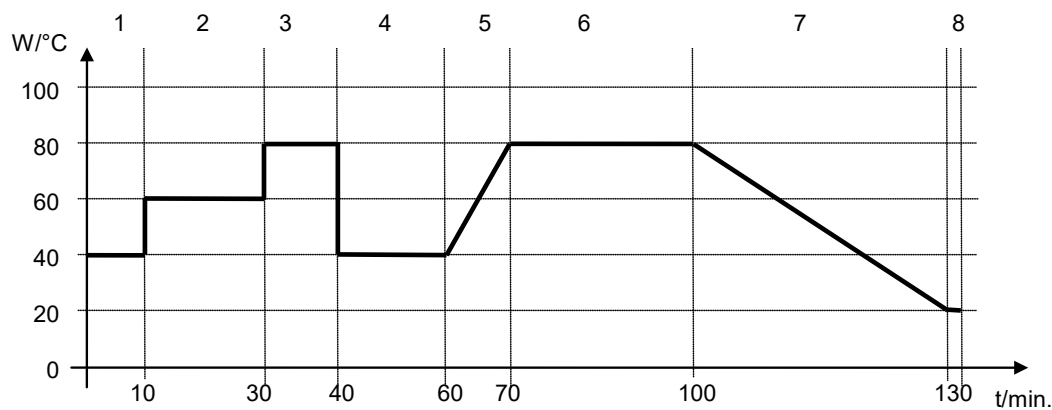

Corresponding program table

| Section No. | Duration [hh:mm:ss] | Temperature [°C] | Pressure mbar] | Ramp or Step |
|-------------|---------------------|------------------|----------------|--------------|
| 1 | 00:10:00 | 40.0 | xxxx | Step |
| 2 | 00:20:00 | 60.0 | xxxx | Step |
| 3 | 00:10:00 | 80.0 | xxxx | Step |
| 4 | 00:20:00 | 40.0 | xxxx | Step |
| 5 | 00:10:00 | 40.0 | xxxx | Ramp |
| 6 | 00:30:00 | 80.0 | xxxx | Ramp |
| 7 | 00:30:00 | 80.0 | xxxx | Ramp |
| 8 | 00:00:01 | 20.0 | xxxx | Ramp |

18.7.3 Special controller functions

In the “**Functions on/off**” menu you can define the switching state of three controller functions.

- Function “Standby” (chap. 9.5)
- Function “GAS/AIR 2” (chap. 11.2)
- Function “Close all valves” (chap. 11.3)

Section view.

Select the field “Functions on/off”.

“Functions on/off” entry menu.

Mark / unmark the checkbox of the desired function to activate / deactivate it and press the **Confirm** icon.

The controller returns to the section view.

| Program 1 - Section number 1 | | 11:43:37 |
|------------------------------|------------------|----------|
| Functions on/off | 0000000000000001 | |
| Number of repetitions | 0 | |
| Start section for repetition | 1 | |
| Temperature | +220.00 | |
| Tolerance band min. | +0.0000 | |
| Tolerance band max. | +0.0000 | |
| Pressure | +1100.0 | |
| Tolerance band min. | +0.0000 | |
| Tolerance band max. | +0.0000 | |

Section view indicating the controller functions.

The functions are displayed from right to left.

Activated function: switching status “1” (On)

Deactivated function: switching status “0” (Off)

Example:

Activated function “Standby” = 0000000000000001

Deactivated function “Standby” = 0000000000000000

18.7.4 Setpoint entry

- Select the field “Temperature” and enter the desired temperature setpoint.
Setting range: 0.0 °C up to 110.0 °C
Confirm entry with **Confirm** icon. The controller returns to the section view.
- Select the field “Pressure” and enter the desired pressure setpoint.
Setting range: 0 mbar up to 1100 mbar
Confirm entry with **Confirm** icon. The controller returns to the section view.

18.7.5 Tolerance range

You can specify a temperature and pressure program tolerance range for each program section with different values for the tolerance minimum and maximum. When the actual value exceeds the given threshold, the program is interrupted. This is indicated on the display (see below). When the actual temperature is situated again within the entered tolerance limits, the program automatically continues. Therefore, the duration of the program may be extended due to the programming of tolerances.

| | |
|---|--|
|  | Programming of tolerances may extend program duration. |
|---|--|

An entry of “-99999” for the tolerance minimum means “minus infinite” and an entry of “999999” for the tolerance maximum means “plus infinite”. Entry of these values will never lead to program interruption. The entry of “0” for the tolerance minimum and/or maximum deactivates the respective tolerance function.

When requesting rapid value transitions, we recommend not programming tolerance values in order to enable the maximum heating-up speed.

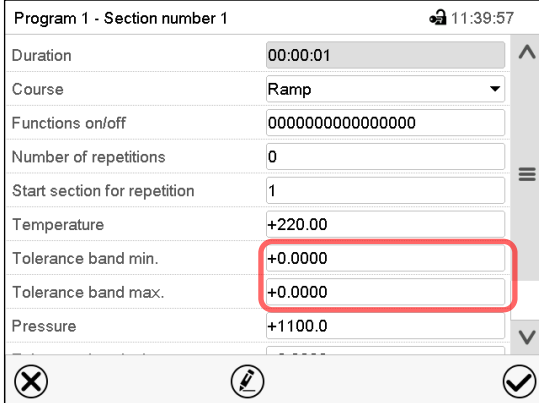

| | | |
|------------------------------|------------------|----------|
| Program 1 - Section number 1 | | 11:39:57 |
| Duration | 00:00:01 | ^ |
| Course | Ramp | ▼ |
| Functions on/off | 0000000000000000 | |
| Number of repetitions | 0 | ≡ |
| Start section for repetition | 1 | |
| Temperature | +220.00 | |
| Tolerance band min. | +0.0000 | |
| Tolerance band max. | +0.0000 | |
| Pressure | +1100.0 | ▼ |

Section view, showing the temperature tolerance range

- Select the field “Tolerance band min” and enter the desired lower tolerance band value. Setting range: -99999 to 99999. Confirm entry with **Confirm** icon. The controller returns to the section view.
- Select the field “Tolerance band max” and enter the desired upper tolerance band value. Setting range: -99999 to 99999. Confirm entry with **Confirm** icon. The controller returns to the section view.

Set the tolerance ranges for other parameters accordingly, if desired.

If one of the actual values (temperature and/or pressure) is outside the program tolerance range the whole program course is interrupted. During this program interruption time the controller equilibrates to the set-points of the current section.

The screen header indicates “Program pause (tolerance band)”. The program runtime indication flashes and does not proceed any further.

When the temperature or pressure values are back within the entered program tolerance range, the program continues automatically.

18.7.6 Repeating one or several sections within a time program

You can repeat several subsequent sections together. It is not possible to define the start section the same time also as the target section, therefore you cannot repeat a single individual section.

Enter the desired number of repetitions in the field “Number of repetitions” and the number of the section to start the repetition cycle with in the field “Start section for repetition” To have sections repeated infinitely, enter the number of repetitions as “-1”.

The selected sections are repeated as many times as selected. Then the program continues.

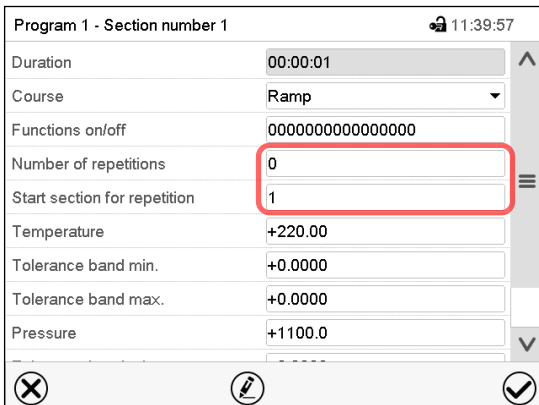

| | | |
|------------------------------|------------------|----------|
| Program 1 - Section number 1 | | 11:39:57 |
| Duration | 00:00:01 | ^ |
| Course | Ramp | ▼ |
| Functions on/off | 0000000000000000 | |
| Number of repetitions | 0 | ≡ |
| Start section for repetition | 1 | |
| Temperature | +220.00 | |
| Tolerance band min. | +0.0000 | |
| Tolerance band max. | +0.0000 | |
| Pressure | +1100.0 | ▼ |

Section view, showing the repetition function

- Select the field “Number of repetitions” and enter the desired number of repetitions. Setting range: 1 to 99, and -1 for infinite. Confirm entry with **Confirm** icon. The controller returns to the section view.
- Select the field “Start section for repetition” and enter the section number, at which the repetition should start. Setting range: 1 up to the section before the currently selected section. Confirm entry with **Confirm** icon. The controller returns to the section view.

18.7.7 Saving the time program

program3 - Section number 1 🔒 18:23:14

Duration ^

Course v

Functions on/off

Number of repetitions

Start section for repetition

Temperature

Tolerance band min.

Tolerance band max.

Pressure v

⊗ ⓘ ✔



program3 - Time program 🔒 18:20:50

| No. | Duration [hh:mm:ss] | Temperature [°C] | Pressure [mbar] | --- | --- |
|-----|---------------------|------------------|-----------------|-----|-----|
| 1 | 00:30:00 | 70.000 | 120.00 | --- | --- |
| 2 | 00:15:00 | 75.000 | 120.00 | --- | --- |
| 3 | 01:00:00 | 75.000 | 100.00 | --- | --- |

⊗ ⓘ ✔

Section view (sample values).

After the all desired values of the program section have been configured, press the **Confirm** icon to take over the programming.

The controller changes to the program view.

Program view (sample program).

Press the **Confirm** icon to take over the programming.

The controller changes to the Normal display.

To save the programming it is absolutely required to press the Confirm icon. Otherwise all settings will be lost! There is no confirmation prompt!

19. Week programs

The MB2 program controller permits programming week programs with real-time reference. It offers 5 week program places in total with up to 100 shift points for each week program.

Path: [Main menu](#) > [Programs](#) > [Week program](#)

For each program section you can enter the moment in time, the temperature set-point, the pressure set-point, and the switching states of the special controller functions.

Before starting the program, check the set-points entered in fixed value mode. After the end of the program, the set-points will equilibrate to these values.

Solvents and forming vapors can ignite if the drying temperature is too high

DANGER

Fire and explosion hazard when exceeding the auto-ignition temperature of the solvent due to excess drying temperature.

Serious injury or death from burns and / or explosion pressure.

- Make sure that only solvents with an auto-ignition temperature that is higher than 200 °C / 392 °F may be entered into the chamber. Check the auto-ignition temperature with the safety specifications of the solvent. In the case of solvent mixtures, use the auto-ignition temperature of the material with the lowest auto-ignition temperature.

19.1 Starting an existing week program

 In Normal display press the **Program start** icon to access the “Program start” menu.

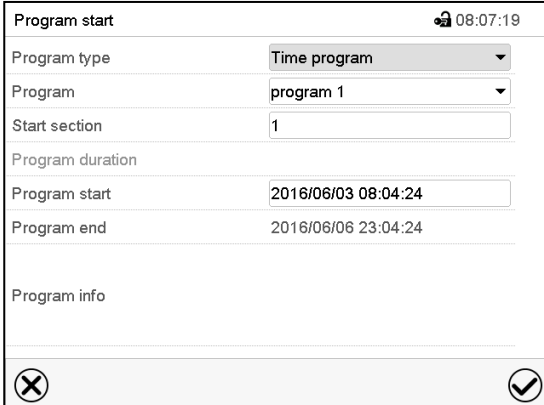

“Program start” menu.

- In the field “Program type” select the setting “Week program”.
- In the field “Program” select the desired program.
- There are no further settings available in the “Program start” menu for week programs, as they are needed only for time programs.

After completing the settings, press the **Confirm** icon to take over the entries and exit the menu. The program starts running.

If instead you press the **Close** icon to exit the menu without taking over the entries, the program will not start.

After starting the week program, the previously entered week program setpoints are active and will be equilibrated according to the current time.

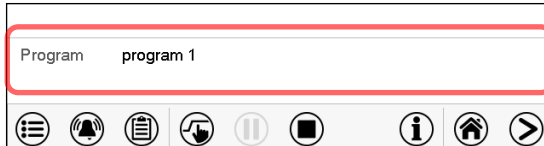

Information on the bottom of the screen indicates the currently running program.

19.2 Cancelling a running week program

 Press the **Program cancelling** icon to cancel the program.

A confirmation prompt is displayed. Press the **Confirm** icon to confirm that the program shall really be cancelled.

After confirming the message, the controller changes to Fixed value operation mode. Temperature and humidity will then equilibrate to the setpoints of Fixed value operation mode.

19.3 Creating a new week program

Path: **Main menu > Programs > Week program**

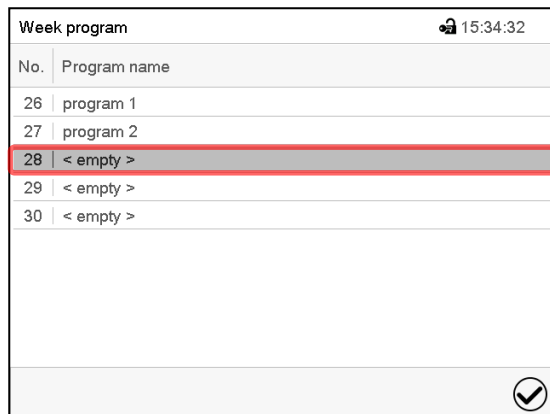

“Week program” menu:
overview of the existing programs.
Select an empty program place.

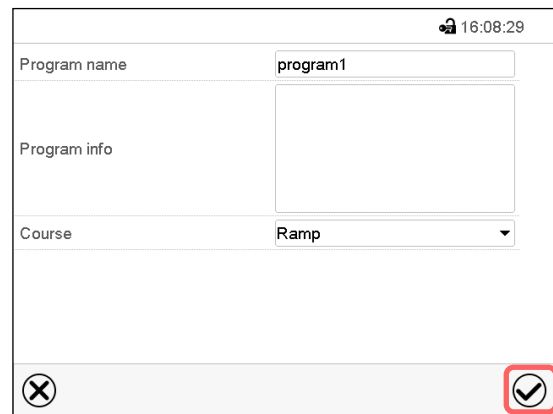

Enter the program name and, if desired, additional program information in the corresponding fields.

Select the set-point course “Ramp” or “Step” (chap. 19.6.1).

Press the **Confirm** icon. The program view opens.

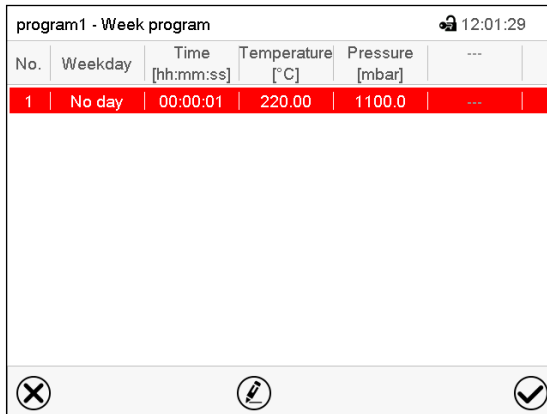
| No. | Weekday | Time [hh:mm:ss] | Temperature [°C] | Pressure [mbar] | ... |
|-----|---------|-----------------|------------------|-----------------|-----|
| 1 | No day | 00:00:01 | 220.00 | 1100.0 | ... |

Program view.
For the first section no weekday is specified.
Therefore the section is first marked in red and cannot be saved.

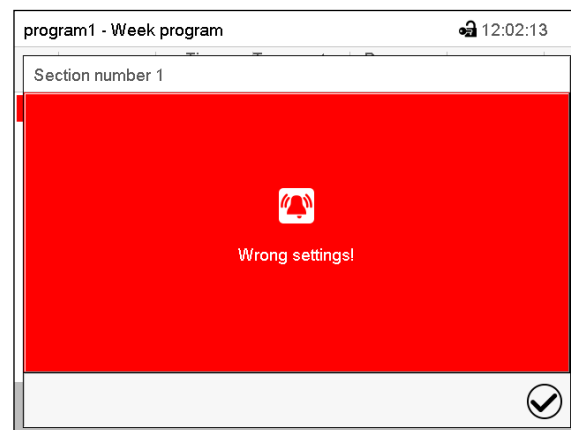

Error message when attempting to save the program

To enter the values, select the program section which is marked in red. You will have access to the **Section view** where you can enter the values of the selected section (chap. 19.6).

19.4 Program editor: program management

Path: **Main menu > Programs > Week program**

| No. | Program name |
|-----|--------------|
| 26 | program 1 |
| 27 | program 2 |
| 28 | < empty > |
| 29 | < empty > |
| 30 | < empty > |

“Week program” menu:
overview of the existing programs.
Select an existing program (example: program 1).



| No. | Weekday | Time [hh:mm:ss] | Temperature [°C] | Pressure [mbar] | ... |
|-----|---------|-----------------|------------------|-----------------|-----|
| 1 | Monday | 08:00:00 | 60.000 | 100.00 | --- |
| 2 | Monday | 14:00:00 | 40.000 | 500.00 | --- |

Program view (example: program 1).

If a new program has been created, there is just one program section.

There are the following options:

- ① Select a program section to open the section editor (chap. 19.5)
- ② Press the **Edit** icon to open the program editor



| program 1 - Week program | |
|--------------------------|--|
| Edit program | |
| Change program name | |
| Copy program | |
| Delete program | |
| Create new section | |

Program editor: “Edit program” menu.

Select the desired function and press the **Confirm** icon.

The program editor offers following options:

- Change program name. This menu also offers to configure the ramp / step mode setting (chap. 19.6.1).
- Copy program
- Replace program: Replacing a new or an existing program with the copied program. This menu point is visible only after a section has been copied.
- Delete program
- Create new section

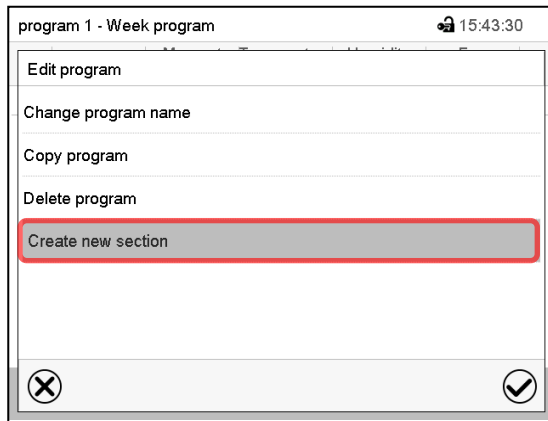

To add a new section, select "Create new section" and press the **Confirm** icon.
The program view opens.

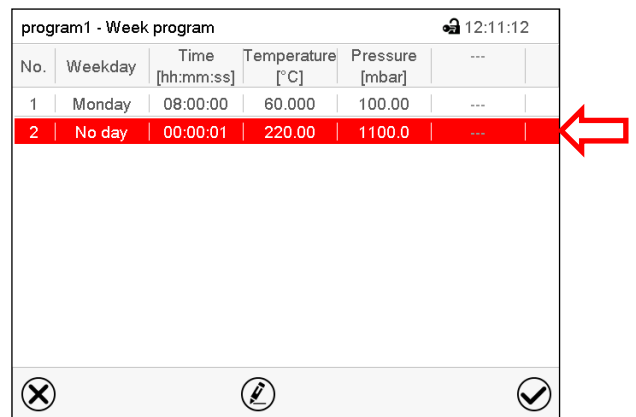

Program view.

With a new section no weekday is specified. Therefore, the section is first marked in red and cannot be saved.

A new section is always added at the very bottom (example: section 3). When the section start is specified the sections are automatically arranged in the correct chronological order.

19.4.1 Deleting a week program

Path: [Main menu](#) > [Programs](#) > [Week program](#)

In the "Week program" menu select the program to be deleted. The program view opens.



In the **program view** press the **Edit** icon to open the program editor



In the **program editor** select "Delete program" and press the **Confirm** icon.
The program is deleted. The controller returns to the program view.

19.5 Section editor: section management

Path: [Main menu](#) > [Programs](#) > [Week program](#)

Select the desired program.

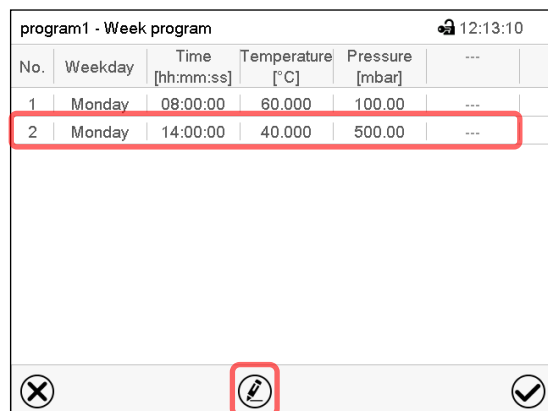

Program view.

Select the desired program section
(example: section 2)

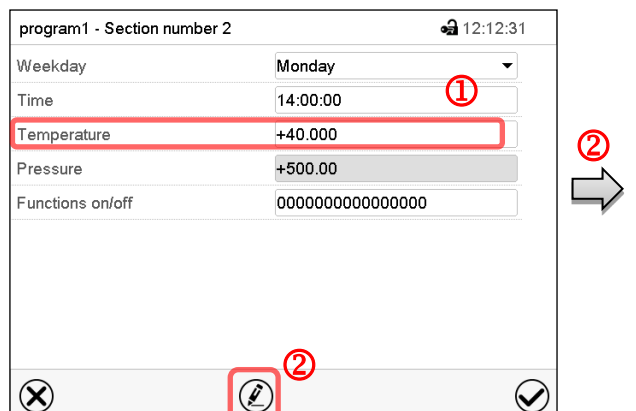

Section view (example: section 2).

There are the following options:

- ① Select a parameter to enter or modify the according value (chap. 19.6)
- ② Press the **Edit** icon to open the program editor

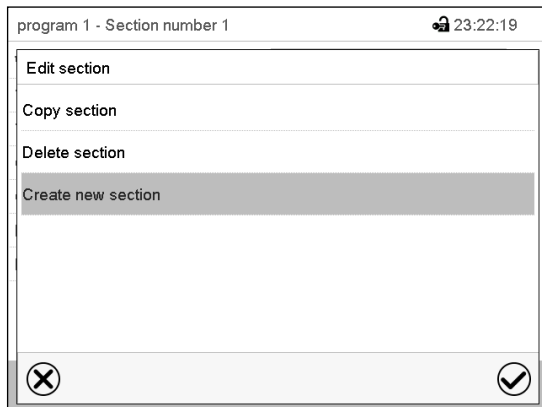

Section editor: "Edit section" menu
 Select the desired function and press the **Confirm** icon.

The section editor offers following options:

- Copy section
- Replace section: Replacing an existing section with the copied section. This menu point is visible only after a section has been copied.
- Insert section: Adding the copied section. This menu point is visible only after a section has been copied.
- Delete section
- Create new section

19.5.1 Add a new program section

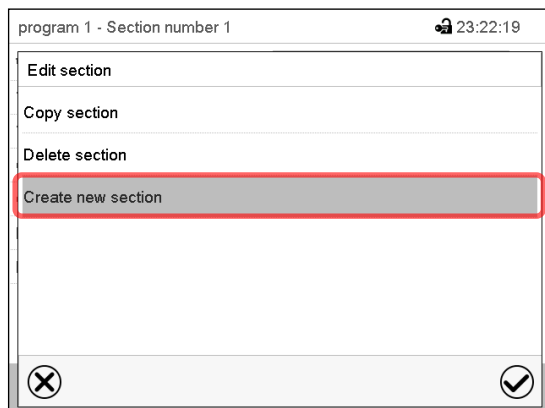

Section editor: "Edit section" menu.
 Select "Create new section" and press the **Confirm** icon.

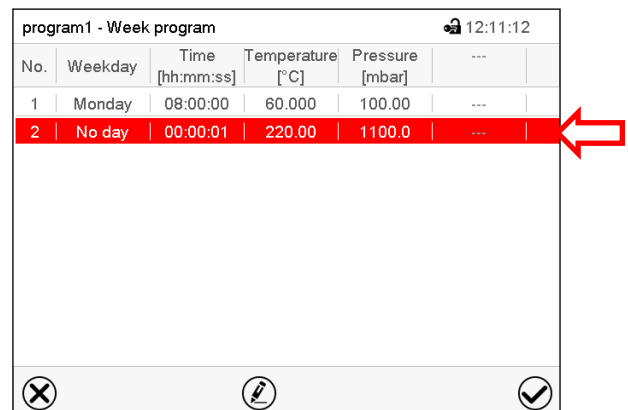
| No. | Weekday | Time [hh:mm:ss] | Temperature [°C] | Pressure [mbar] | ... | ... | ... |
|-----|---------|-----------------|------------------|-----------------|-----|-----|-----|
| 1 | Monday | 08:00:00 | 60.000 | 100.00 | ... | ... | ... |
| 2 | No day | 00:00:01 | 220.00 | 1100.0 | ... | ... | ... |

Program view.

With a new section no weekday is specified. Therefore, the section is first marked in red and cannot be saved.

A new section is always added at the very bottom (example: section 3). When the section start is specified the sections are automatically arranged in the correct chronological order.

19.5.2 Copy and insert or replace a program section

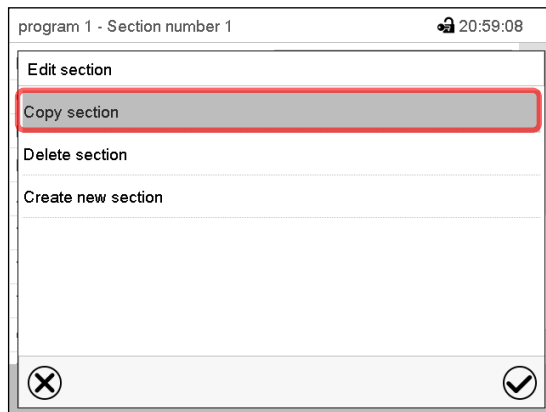

Section editor: “Edit section” menu
 Select “Copy section” and press the **Confirm** icon.
 The current section (example: section 1) is copied.
 The controller returns to the program view.

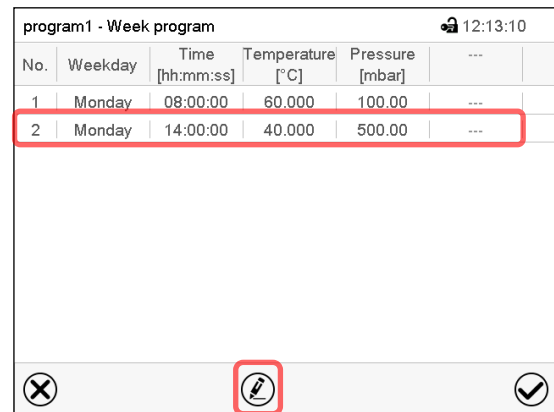

Program view
 Select the section to be replaced or before or after which the copied section shall be inserted (example: section 2).
 Press the **Confirm** icon
 The controller returns to the section editor

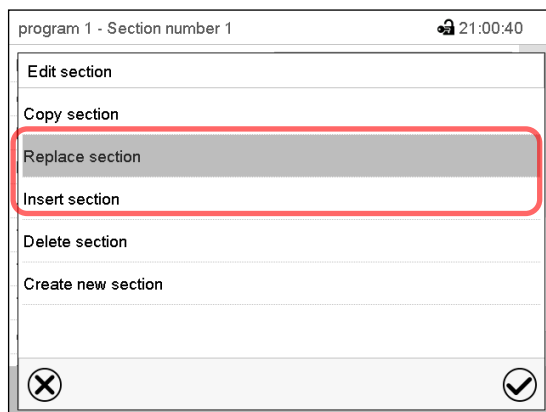

Section editor: “Edit section” menu

Select “Replace section” to replace the selected section with the copied section
 or
 Select “Insert section” to additionally add the copied section.
 Press the **Confirm** icon.
 If you selected “Insert section” the sections are automatically arranged in the correct chronological order.

19.5.3 Deleting a program section

In the **program view** select the program section to be deleted. The section view opens.



In the **section view** press the **Edit** icon to open the section editor



In the **section editor** select “Delete section” and press the **Confirm** icon.
 The section is deleted. The controller returns to the section view.

19.6 Value entry for a program section in the Section view

Path: [Main menu](#) > [Programs](#) > [Week program](#)

Select the desired program and section.

19.6.1 Set-point ramp and set-point step modes

The explanation of the settings “Ramp” or “Step” is given in chap. 18.7.2.

You can define the type of temperature and pressure transitions for the entire week program.

Select the desired program and press the **Edit** icon to open the program editor. In the program editor select the “Change program name” function and press the **Confirm** icon.

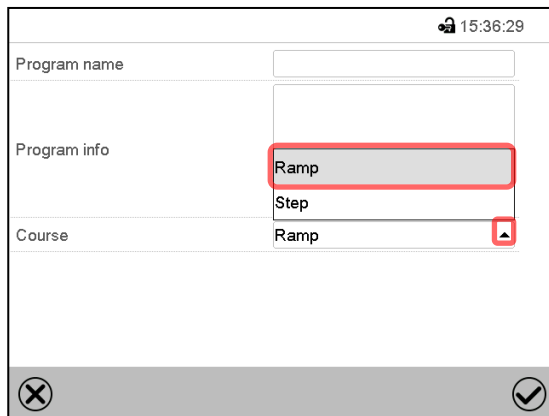

“Change program name” menu.

In the field “Course” select the desired setting “Ramp” or “Step” and press the **Confirm** icon.

19.6.2 Weekday

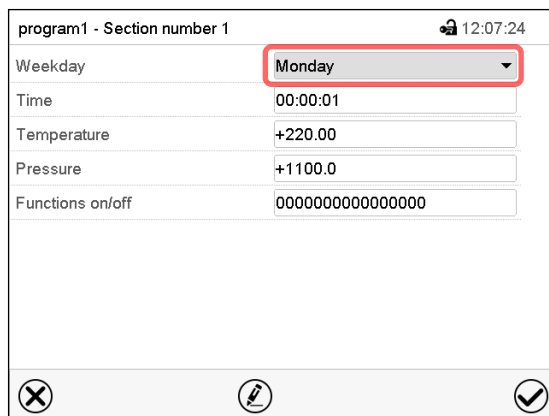

Section view.

In the field “Weekday” select the desired weekday.

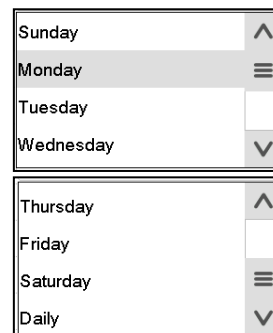

With “Daily” selected, this section will run every day at the same time.

19.6.3 Start time

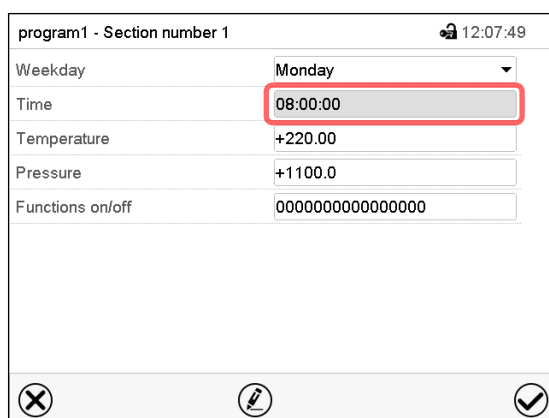

Section view.

Select the field “Moment”.

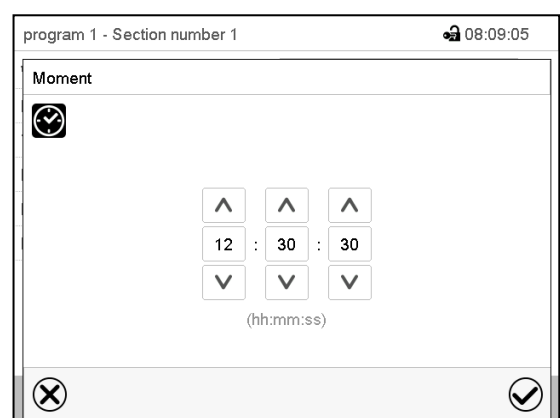

Entry menu “Moment”.

Select with the arrow keys the desired start moment of the section and press the **Confirm** icon.

19.6.4 Setpoint entry

| program1 - Section number 1 | | 🔒 12:09:47 |
|-----------------------------|------------------|------------|
| Weekday | Monday | ▼ |
| Time | 08:00:00 | |
| Temperature | +60.000 | |
| Pressure | +100.00 | |
| Functions on/off | 0000000000000000 | |

✕ ✎ ✔

Section view.

- Select the field “Temperature” and enter the desired temperature setpoint.

Setting range: 0.0 °C up to 110.0 °C

Confirm entry with **Confirm** icon. The controller returns to the section view.

- Select the field “Pressure” and enter the desired pressure setpoint.

Setting range: 0 mbar up to 1100 mbar

Confirm entry with **Confirm** icon. The controller returns to the section view.

19.6.5 Special controller functions

| program1 - Section number 1 | | 🔒 12:09:47 |
|-----------------------------|------------------|------------|
| Weekday | Monday | ▼ |
| Time | 08:00:00 | |
| Temperature | +60.000 | |
| Pressure | +100.00 | |
| Functions on/off | 0000000000000000 | |

✕ ✎ ✔

Section view.

In the “**Functions on/off**” menu you can define the switching state of three controller functions.

- Function “Standby” (chap. 9.5)
- Function “GAS/AIR 2” (chap. 11.2)
- Function “Close all valves” (chap. 11.3)

For details please refer to chap. 18.7.3.

After the all desired values of the program section have been configured, press the **Confirm** icon. The controller changes to the program view

20. Network and communication

For the network and communication settings at least the “Admin” authorization level is required.

20.1 Ethernet

20.1.1 Configuration

Path: [Main menu](#) > [Settings](#) > [Ethernet](#)

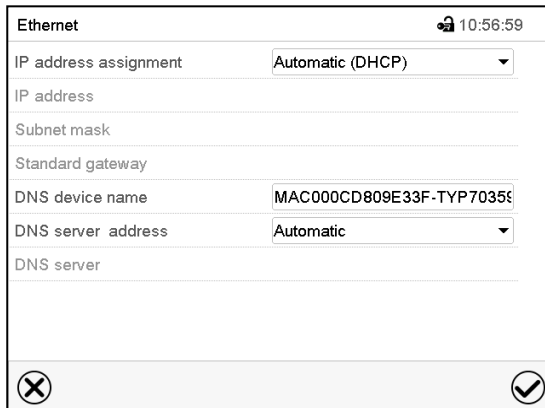

“Ethernet” submenu.

- In the field “IP address assignment” select the desired setting “Automatic (DHCP)” or “Manual”.

With selection “Manual” you can enter the IP-address, the subnet mask and the standard gateway manually.

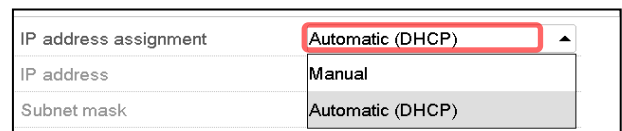
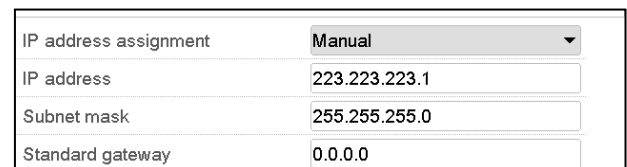
- Select “DNS device name” and enter the DNS device name. Confirm entry with **Confirm** icon.
- In the field “DNS server address” select the desired setting “Automatic” or “Manual”.

With selection “Manual” you can enter the DNS server address manually.

After completing the settings, press the **Confirm** icon to take over the entries and exit the menu, **or** press the **Close** icon to exit the menu without taking over the entries.

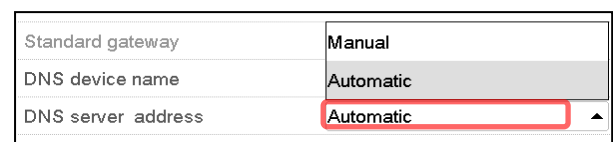
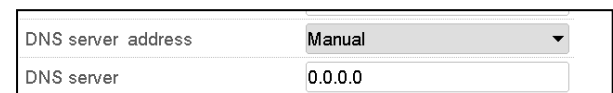
20.1.2 Display of MAC address

Path: [Main menu](#) > [Device info](#) > [Ethernet](#)

| Ethernet | | 🔒 13:49:56 |
|------------------|---------------------------|---|
| Ethernet | Yes | ^ ≡ v |
| MAC address | 00-0C-D8-09-E3-3F | |
| IP address | 192.168.14.87 | |
| Subnet mask | 255.255.255.0 | |
| Standard gateway | 192.168.14.1 | |
| DNS server | 192.168.10.5 | |
| DNS device name | MAC000CD809E33F-TYP703596 | |
| | | |
| | | |
| | | |

“Ethernet” submenu (example).

20.2 Web server

This controller menu serves to configure the web server. Then you can enter the chamber’s IP-address in the Internet. The IP address is available via [Chamber information](#) > [Ethernet](#). The BINDER web server opens. Enter the user name and password which have been assigned for the web server in the controller menu. This enables online access to the controller display, to see e.g., the event list or error messages. In this view no settings can be changed.

Path: [Main menu](#) > [Settings](#) > [Web server](#)

| Web server | | 🔒 11:08:32 |
|-------------------------|-------|------------|
| Password active | Yes | |
| User name | admin | |
| Password | 1234 | |
| Automatic log out after | 0 Min | |

“Webserver” submenu.

- In the field “Password active” select the desired setting “Yes” or “No”.

| | |
|-----------------|-----|
| Password active | Yes |
| User name | No |
| Password | Yes |

- Select the field “User name” and enter the desired user name. Confirm entry with **Confirm** icon.
- Select the field “Password” and enter the desired password. Confirm entry with the **Confirm** icon.
- Select the field “Automatic log out after” and enter the time in minutes after which the webserver shall log out automatically. Setting range: 0 min to 65535 min. Confirm entry with **Confirm** icon.

After completing the settings, press the **Confirm** icon to take over the entries and exit the menu, **or** press the **Close** icon to exit the menu without taking over the entries.

20.3 E-Mail

As soon as an alarm was triggered, an e-mail is sent to the configured e-mail address.

Path: [Main menu](#) > [Settings](#) > [Email](#)

E-mail address entry:

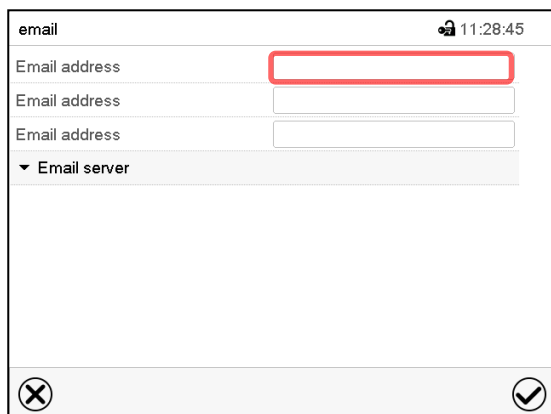

“Email” submenu.

Select the desired e-mail address field and enter the e-mail address. You can use the **Keyboard change** icon for entry. Confirm entry with **Confirm** icon.

E-mail server settings:

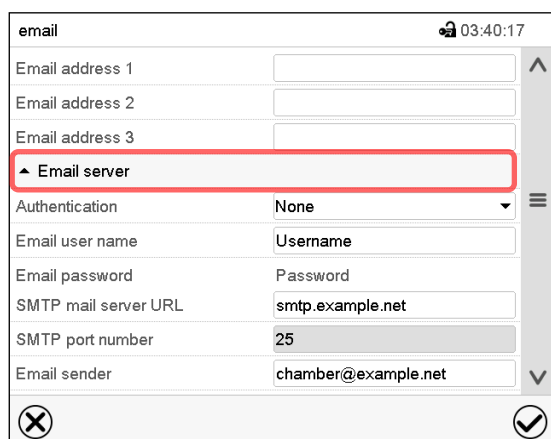

“Email” submenu.

Select the field “Email server” to access the settings

- In the field “Authentication” select the desired setting “None” or “SMTP” auth“.

With the setting “SMTP auth”, you can enter a password under “Email password”.

| | |
|----------------------|---------------|
| Authentication | None |
| Email user name | None |
| Email password | SMTP auth |
| SMTP mail server URL | 192.168.10.45 |

- Select the field “Email user name” and enter the desired user name. Confirm entry with **Confirm** icon.
- Select the field “SMTP mail server URL” and enter the SMPT mail server URL. Confirm entry with **Confirm** icon.
- Select the field “SMTP port number” and enter the desired port number. Standard setting: “25”. Confirm entry with **Confirm** icon.
- Select the field “Email sender” and enter the desired Email sender. Confirm entry with **Confirm** icon.

After completing the settings, press the **Confirm** icon to take over the entries and exit the menu, **or** press the **Close** icon to exit the menu without taking over the entries.

21. USB menu: Data transfer via USB interface

21.1 Using the USB connection during chamber operation

- Turn the pressure regulator on the chamber rear until the clamping ring touches the lower stop (turn clockwise. This gives the maximum overpressure.
- Open the USB cover on the controller housing (triangle instrument box)
- Observe the display of the manometer: The overpressure must not drop below 25 Pa (recommendation: >40 Pa).
- Connect the USB stick.
- If the USB stick remains on the unit for a longer period of time, the pressure can be set to an overpressure of at least 25 Pa (recommendation: >40 Pa) on the pressure regulator.
- Close the USB cover on the controller housing (triangle instrument box)
- Now the pressure regulator can be turned back (counter-clockwise rotation) until the clamping ring touches the upper stop. (Only tighten to the stop by hand)

The USB port is located in the controller housing (triangle instrument box).

When you insert a USB-stick, the “USB” menu opens. Depending on the user’s authorization level, different functions (highlighted in black) are available for the logged-in user.

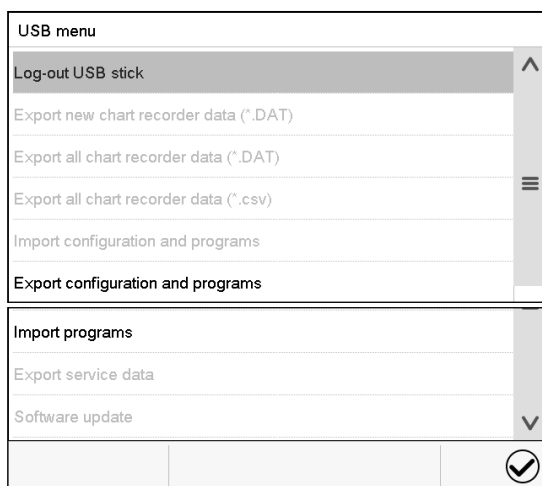

Available functions
with “User” authorization level

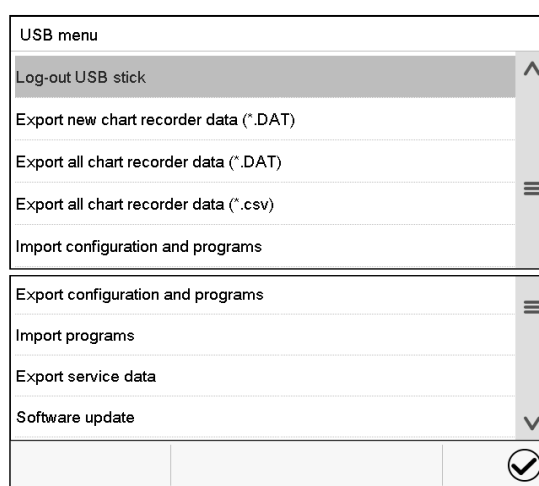

Available functions
with “Admin” authorization level

| Function | Explanation |
|--|---|
| Log-out USB stick | Log-out USB stick bevor pulling it |
| Export new chart recorder data (*.DAT) | Export chart recorder data, which have been added since last export, in .dat format |
| Export all chart recorder data (*.DAT) | Export all chart recorder data in .dat format |
| Export all chart recorder data (*.csv) | Export all chart recorder data in .csv format |
| Import configuration and programs | Import configuration and timer / time / week programs |
| Export configuration and programs | Export configuration and timer / time / week programs |
| Import programs | Import timer / time / week programs |
| Export service data | Export service data |
| Software update | Controller firmware update |

22. Chart recorder display

This view offers graphic representation of the measurement course. Data representation imitates a chart recorder and allows recalling any set of measured data at any point of time taken from the recorded period.

22.1 Views

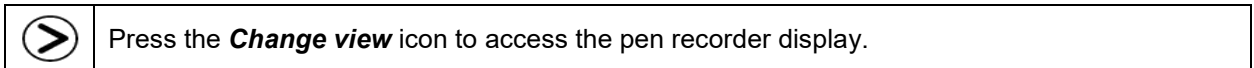

22.1.1 Show and hide legend



Press the **Show legend** icon to display the legend on the right side of the display

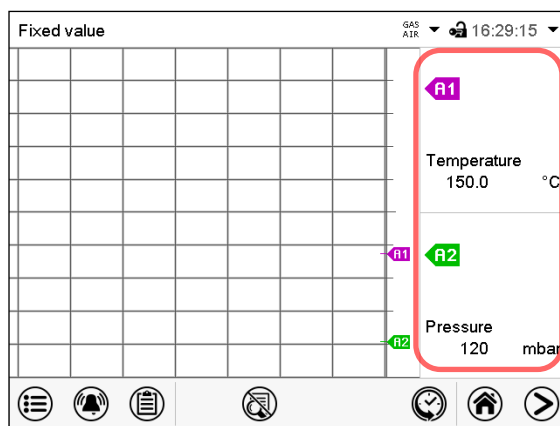

Legend shown on the right side of the display

22.1.2 History display



Press the **History display** icon to change to the history display.

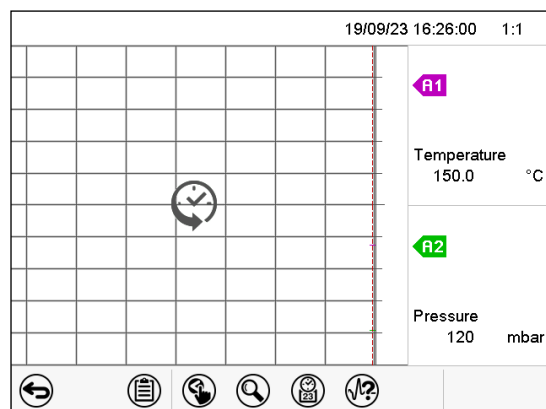

History display with legend shown.

The chart recorder is paused. Data recording continues in the background.

Move the central red line by tapping and holding to the desired position.

The legend at the right side shows the values of the current line position.

Then further icons appear:

History display: Curve selection

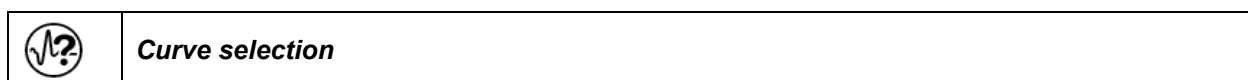

Press the **Curve selection** icon to access the “Curve selection” submenu.

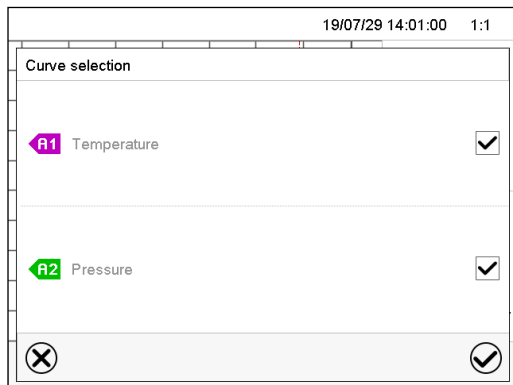

“Curve selection” submenu.

Select the curves to be displayed by checking the checkbox of the corresponding parameter. Press the **Confirm** icon

History display: Search the required instant

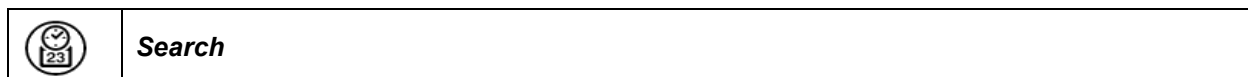

Press the **Search** icon to access the “Search” submenu.

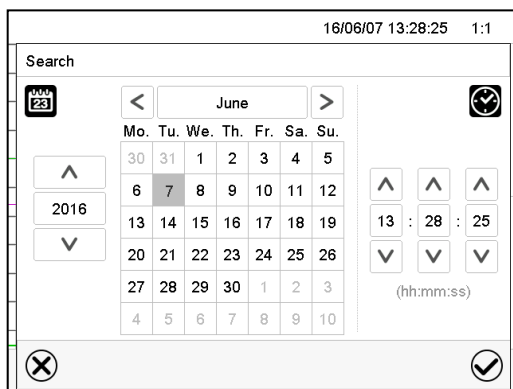

“Search” submenu.

Select the required instant by entering its date and time and press the **Confirm** icon

History display: Zoom function

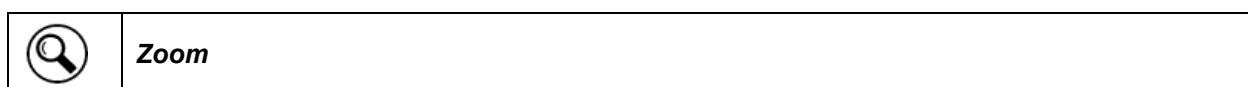

Press the **Zoom** icon to access the “Zoom” submenu.

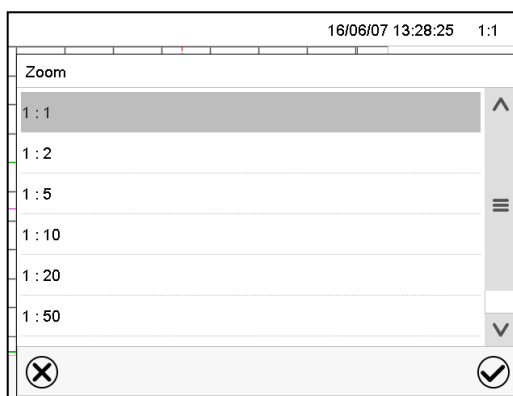

“Zoom” submenu.

Select the zoom factor and press the **Confirm** icon

History display: Show and hide scroll buttons to scroll to an instant

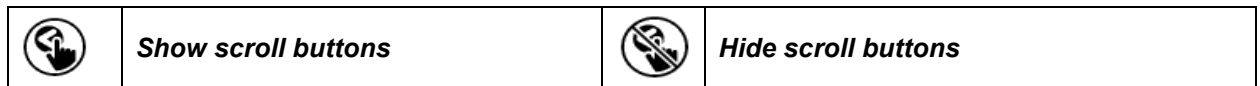

Press the **Show scroll buttons** icon to access the “Page selection” submenu.

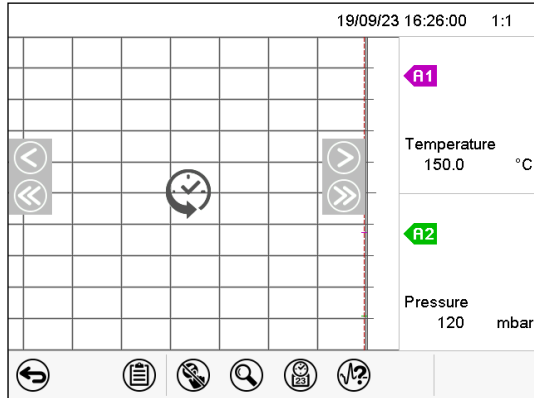

“Page selection” submenu.

Scroll buttons are shown on the left and on the right. Use them to move along the timeline.

22.2 Setting the parameters

This menu allows setting the storage interval, the type of values to be shown and the scaling of the temperature and humidity charts.

Path: [Main menu](#) > [Settings](#) > [Measurement chart](#)

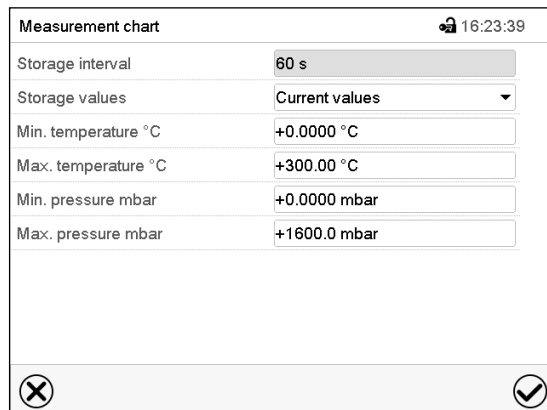

“Measurement chart” submenu.

- Select the field “Storage interval” and enter the desired storage interval. Confirm entry with **Confirm** icon.

The available presentation depends on the pre-selected storage rate. Factory setting: 60 seconds. This means the higher the storage rate, the more precisely but shorter the data representation will be.

- In the field “Storage values” select the desired value type to be displayed.

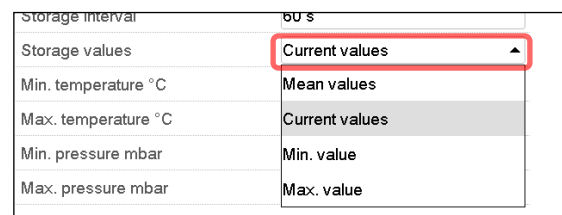

- For scaling the representation select the desired minimum and maximum temperature or pressure value and enter the desired values. Temperature display range: 0 °C up to 300 °C. Pressure display range: 0 mbar up to 1600 mbar. Confirm each entry with **Confirm** icon.

Setting the storage rate or rescaling (minimum and/or maximum) will clear the measured-value memory and the event list.

| | |
|---|--|
|  | NOTICE |
| | <p>Danger of information loss when setting the storage rate or rescaling. Data loss of measured-value memory and event list.</p> <p>➤ Change the storage rate or scaling ONLY if the previously registered data is no longer needed.</p> |

After completing the settings, press the **Confirm** icon to take over the entries and exit the menu, **or** press the **Close** icon to exit the menu without taking over the entries.

23. Reference measurements

23.1 Checking the temperature in the inner chamber

The controller display was adjusted in the factory to the temperature in the center of the usable volume (chap. 28.1). The sensor probe of the reference measuring device was connected tightly to an expansion rack positioned in the middle of the chamber.

23.1.1 Checking the controller display

- Conduct the reference sensor into the inner chamber through the measuring port (12). The port must be largely vacuum tight to enable a typical operation vacuum for the calibration. Use e.g., a silicone plug with a hole for the sensor wire.
- Fix the sensor to the center of an expansion rack in the middle of the useable volume with adhesive aluminum tape or thermal conductive paste to ensure sufficient thermal conductivity.
- Perform the measurement in a thermally stable condition with 3 expansion racks and empty oven.
- Equilibrating time: at least 12 hours.

23.1.2 Checking the spatial temperature exactitude

- Fix at least 9 sensor probes on 3 racks with adhesive aluminum tape or thermal conductive paste to ensure sufficient thermal conductivity
- The distance of the sensor probes to all inner chamber walls must be at least 10% of the corresponding inner chamber dimension (see DIN 12880:2007).
- Perform the measurement in a thermally stable condition with 3 expansion racks and empty oven.
- Response time: at least 12 hours.



Do NOT use the temperature probe of the reference measurement device without any contact to the expansion rack, i.e., do NOT measure vacuum values!



In case the temperature probe is a thermo element, mount it so it is electrically insulated from the rack.

If you note an excessive divergence between the controller and reference temperatures, please contact BINDER Service to calibrate the temperature controller.

23.1.3 Checking the function of the manometer for compressed air sweeping

We recommend checking the manometer display for compressed air sweeping in the chamber door at least once a year.

Via the outlet with sweeping plug for compressed air sweeping before start-up (11), the manometer display in the door can be tested with a reference manometer.

- Remove the sweeping plug and attach a hose to the tube \varnothing 8 mm of the outlet (11).
- Open the USB cover on the controller housing (triangular instrument box)
- Use the pressure regulator to set a visible value on the manometer.
- Measure the pressure at the outlet (11) and compare it to the manometer display

The acceptable deviation between the manometer display of the chamber and the reference measuring device is ± 10 Pa.

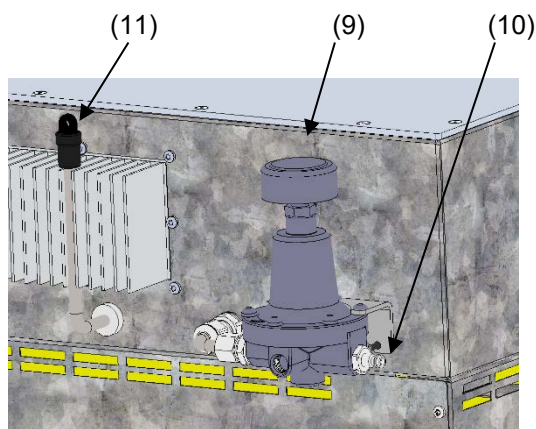

- (9) Pressure regulator for compressed air sweeping
- (10) Connection for compressed air sweeping / overpressure
- (11) Outlet with sweeping plug for compressed air sweeping before start-up

Figure 27: Pressure regulator and sweeping plug for compressed air sweeping on the chamber rear

24. Options

24.1 APT-COM™ 4 Multi Management software (option)



The chamber is regularly equipped with an Ethernet interface (2) that can connect the BINDER APT-COM™ 4 Multi Management Software.

The MAC Address is indicated in the “Device info” controller menu (chap. 20.1.2).

The actual temperature and pressure values are given at adjustable intervals. Programming can be performed graphically via PC.

Up to 100 chambers can be cross-linked. For further information please refer to the APT-COM™ 4 operating manual.

The plug connection of the analog output is unprotected and must therefore be established outside a zone.

| | |
|--|---|
|  |  DANGER |
| <p>Explosion hazard due to sparking when disconnecting an electrical connection. Serious injury or death from burns and / or explosion pressure.</p> <ul style="list-style-type: none"> ➤ Make sure that the plug connection for Ethernet is located outside a zone. ➤ Make sure that the plug connection for Ethernet is located outside the installation area of the VDL and the pump. Take into account the information on zone classification (chap. 3.5.2) | |

24.2 Analog outputs for temperature and pressure (option)

With this option, the chamber is equipped with analog outputs 4-20 mA for temperature and pressure. These outputs allow transmitting data to external data registration systems or devices.

A 2-meter connection cable is firmly connected to the connection “Analog output” (3b) located in the VDL rear connection panel. The connection of this cable is realized as a 9-poles SUB-D socket as follows:

ANALOG OUTPUT 4-20 mA DC

PIN 1: Temperature +

PIN 2: Temperature –

PIN 4: Pressure +

PIN 5: Pressure –

Temperature range: 0 °C to +110 °C, pressure range: 0 mbar to 1100 mbar

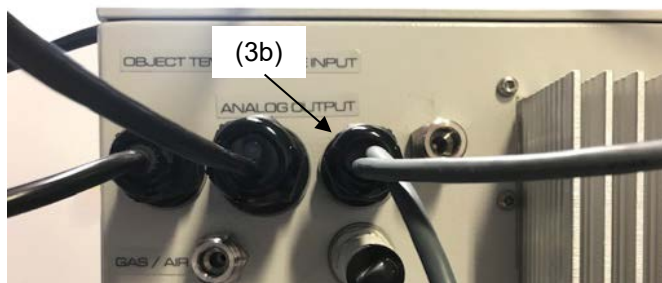



Figure 28: Connection cable on the “Analog output” (3b) connection



Figure 29: SUB-D socket for the analog outputs option

A suitable plug is enclosed. Please note that the plug connection of the analog output is unprotected and must therefore be established outside a zone.

| | |
|---|--|
|  |  DANGER |
| | <p>Explosion hazard due to sparking when disconnecting an electrical connection. Serious injury or death from burns and / or explosion pressure.</p> <ul style="list-style-type: none"> ➤ Make sure that the plug connection of the analog outputs is located outside a zone. ➤ Make sure that the plug connection of the analog outputs is located outside the installation area of the VDL and the pump. Take into account the information on zone classification (chap. 3.5.2) |

24.3 Object temperature display with flexible Pt 100 temperature sensor (option)

The object temperature display permits recording the object temperature directly on or in the drying material. This enables the determination of the actual temperature of the charging material during the whole process. The object temperature is measured via a flexible Pt100 sensor inside the inner chamber and can be viewed on the controller display. The sensor needs to be in thermally conducting contact with the charging material. It can be plunged into humid charging material up to the length of its protecting tube.

The intrinsically safe connection cable is firmly connected (via an isolation amplifier) to the connection "Object temperature input" (3a) located in the VDL rear connection panel. This cable connection is realized as a Lemo socket, which will be connected to a measuring access port on the measuring connection (12) in the rear panel of the chamber.

24.3.1 Connection of the object temperature sensor

- Insert the Pt 100 temperature sensor from the rear through the measuring connection (12) into the inner chamber.
- The 3 contacts of the Pt 100 sensor are conducted outside via a measuring access port. For reasons of explosion protection, this electrical connection to the inner chamber is conducted via a triple internal safety barrier with a conducting-state voltage of 1.6 Volt maximum against ground.



Technical data of the Pt 100 sensor:

- Three-wire technique
- Class B (DIN EN 60751)
- Temperature range up to 320 °C / 608 °F
- Stainless steel protective tube, length 45 mm / 1.77 in, stainless steel material no. 1.4501

Figure 30: Measuring connection (12) with measuring access port

- Establish a plug connection between the measuring access port and the Lemo socket of the cable, which is connected to the connection (3a)



Figure 31: Connection cable on the “Object temperature input” connection (3a)

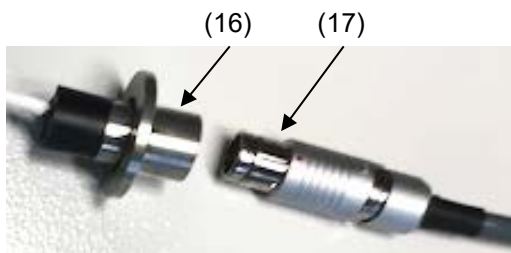

Figure 32: Plug connection between measuring access port and Lemo socket

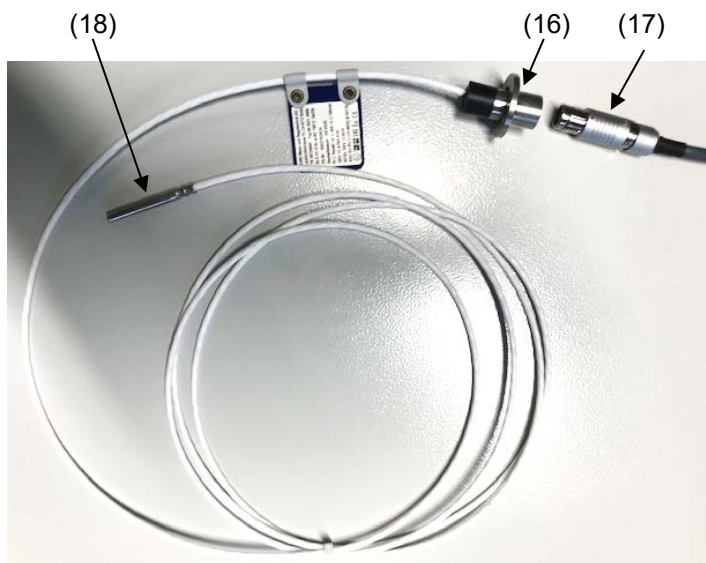

Figure 33: Cable connection of the optional Pt 100 sensor

- (16) Measuring access port for Object temperature display
- (17) Lemo socket
- (18) Pt 100 Temperature sensor

- For the correct function and temperature display of the device, this plug connection must not be disconnected.

| | |
|--|---|
| | NOTICE |
| | Danger of malfunctions by disconnecting the plug connection of the object temperature display. |
| | Incorrect regulation and display of the temperature. |
| | ∅ Do NOT disconnect the plug connection of the object temperature display. |

24.3.2 Display on the MB2 controller

| Fixed value | | 09:05:00 | |
|-------------|------|-------------|--------------|
| | | Setpoint | Actual value |
| Temperature | °C | 40.0 | 40.1 |
| Pressure | mbar | 1100 | 1024 |
| Obj. Temp. | °C | | 10.6 |

Normal display with object temperature display (sample values)



The object temperature data are put out together with the data of the temperature controller to the chamber's interface and can be documented by the APT-COM™ 4 Multi Management Software (option, chap. 24.1) developed by BINDER.

25. Cleaning and decontamination





Clean the chamber after each use to avoid potential corrosion damage by ingredients of the charging material. .

25.1 Safety instructions on cleaning and decontamination



During cleaning and decontamination, no explosive atmosphere may be present in the installation area of the chamber and inside the chamber.

| | |
|---|---|
|  |  DANGER |
| | <p>Fire and explosion hazard due to explosive atmosphere during cleaning and decontamination.</p> <p>Serious injury or death from burns and / or explosion pressure.</p> <ul style="list-style-type: none"> ➤ Before performing any cleaning and decontamination measures, make sure that there is no explosive atmosphere in the installation area of the chamber or inside the chamber. ⊘ Do NOT clean the chamber in potentially explosive areas. ➤ Before commissioning, ensure that the system is correctly and completely grounded |

Prior to renewed startup, allow the chamber to completely dry after all cleaning and decontamination measures.

| | |
|---|---|
|    |  DANGER |
| | <p>Electrical hazard by water entering the chamber.</p> <p>Deadly electric shock.</p> <ul style="list-style-type: none"> ➤ Make sure that the chamber will not become wet during cleaning or decontamination. ⊘ Do NOT spill water or cleaning agents over the inner and outer chamber surfaces. ⊘ Do NOT put ANY cleaning aids (cloth or brush) into slots or openings on the chamber. ➤ Make sure that no water will enter into slots or openings on the chamber, especially in the area of the door hinges. ➤ Before cleaning, disconnect the power plug. Let the chamber cool down to ambient temperature. ➤ Completely dry the chamber before turning it on again. |

Avoid electrostatic charges.

| | |
|--|---|
|   |  DANGER |
| | <p>Explosion hazard due to electrostatic charge when rubbing with a dry cloth.</p> <p>Serious injury or death from burns and / or explosion pressure.</p> <ul style="list-style-type: none"> ➤ Use only damp cloth when wiping the device. You may use water and the specified cleaning agents. ⊘ NEVER wipe the device with a dry cloth. |

25.2 Cleaning

Disconnect the oven from the power supply before cleaning. Disconnect the power plug.

| | |
|---|---|
|  | The interior of the chamber must be kept clean. Thoroughly remove any residues of the charging material |
|---|---|

Wipe the surfaces with a moistened towel. In addition, you can use the following cleaning agents:

| | |
|--|---|
| Exterior surfaces, inner chamber, door gaskets | Standard commercial cleaning detergents free from acid or halides. Alcohol based solutions. We recommend using the neutral cleaning agent Art. No. 1002-0016. |
| Expansion racks, rack holders | Standard commercial cleaning detergents free from acid or halides, no salt solution or chlorinated solvents. We recommend using the neutral cleaning agent Art. No. 1002-0016. |
| Controller housing (triangular instrument box) | Standard commercial cleaning detergents free from acid or halides. We recommend using the neutral cleaning agent Art. No. 1002-0016. |
| Zinc coated hinge parts rear chamber wall | Standard commercial cleaning detergents free from acid or halides. Do NOT use a neutral cleaning agent on zinc coated surfaces. |

Do not use cleaning agents that may cause a hazard due to reaction with components of the device or the charging material. If there is doubt regarding the suitability of cleaning products, please contact BINDER service.

| | |
|---|--|
|  | We recommend using the neutral cleaning agent Art. No. Art. 1002-0016 for a thorough cleaning. Any corrosive damage that may arise following use of other cleaning agents is excluded from liability by BINDER GmbH. Any corrosive damage caused by a lack of cleaning, is excluded from liability by BINDER GmbH. |
|---|--|

| | |
|---|--|
|  | NOTICE |
| | <p>Danger of corrosion by using unsuitable cleaners. Damage to the chamber.</p> <ul style="list-style-type: none"> ∅ Do NOT use acidic or chlorine cleaning detergents. ∅ Do NOT use a neutral cleaning agent on other kind of surfaces e.g., the zinc coated hinge parts or the rear chamber wall. |

| | |
|---|--|
|  | For surface protection, perform cleaning as quickly as possible. After cleaning completely remove cleaning agents from the surfaces with a moistened towel. Let the chamber dry. |
|---|--|





| | |
|---|---|
|  | Soapsuds may contain chlorides and must therefore NOT be used for cleaning. |
|---|---|

| | |
|---|---|
|  | With every cleaning method, always use adequate personal safety controls. |
|---|---|

Following cleaning, leave the chamber door open or remove the access port plugs.

| | |
|---|---|
|  | <p>The neutral cleaning agent may cause health problems in contact with skin and if ingested. Follow the operating instructions and safety hints labeled on the bottle of the neutral cleaning agent.</p> |
|---|---|

Recommended precautions: To protect the eyes use sealed protective goggles. Suitable protective gloves with full contact: butyl or nitrile rubber, penetration time >480 minutes.

| | | | | | | | | | | | | | | | |
|---|--|---|--|---|--|--|--|---|--|--|--|--|--|--|--|
|  | <table border="1"> <tr> <td colspan="2" data-bbox="544 465 1487 539" style="background-color: yellow; text-align: center;">  CAUTION </td> </tr> <tr> <td colspan="2" data-bbox="544 546 1487 611"> <p>Danger of chemical burns due to contact with skin or ingestion of the neutral cleaning agent.</p> </td> </tr> <tr> <td colspan="2" data-bbox="544 618 1487 651"> <p>Skin and eye damage. Environmental damage.</p> </td> </tr> <tr> <td colspan="2" data-bbox="544 658 1487 692"> <p>Ø Do NOT empty the neutral cleaning agent into drains.</p> </td> </tr> <tr> <td colspan="2" data-bbox="544 698 1487 763"> <p>Ø Do not ingest the neutral cleaning agent. Keep it away from food and beverages.</p> </td> </tr> <tr> <td colspan="2" data-bbox="544 770 1487 804"> <p>➤ Wear protective gloves and goggles.</p> </td> </tr> <tr> <td colspan="2" data-bbox="544 810 1487 844"> <p>➤ Avoid skin contact with the neutral cleaning agent.</p> </td> </tr> </table> |  CAUTION | | <p>Danger of chemical burns due to contact with skin or ingestion of the neutral cleaning agent.</p> | | <p>Skin and eye damage. Environmental damage.</p> | | <p>Ø Do NOT empty the neutral cleaning agent into drains.</p> | | <p>Ø Do not ingest the neutral cleaning agent. Keep it away from food and beverages.</p> | | <p>➤ Wear protective gloves and goggles.</p> | | <p>➤ Avoid skin contact with the neutral cleaning agent.</p> | |
|  CAUTION | | | | | | | | | | | | | | | |
| <p>Danger of chemical burns due to contact with skin or ingestion of the neutral cleaning agent.</p> | | | | | | | | | | | | | | | |
| <p>Skin and eye damage. Environmental damage.</p> | | | | | | | | | | | | | | | |
| <p>Ø Do NOT empty the neutral cleaning agent into drains.</p> | | | | | | | | | | | | | | | |
| <p>Ø Do not ingest the neutral cleaning agent. Keep it away from food and beverages.</p> | | | | | | | | | | | | | | | |
| <p>➤ Wear protective gloves and goggles.</p> | | | | | | | | | | | | | | | |
| <p>➤ Avoid skin contact with the neutral cleaning agent.</p> | | | | | | | | | | | | | | | |

25.3 Decontamination / chemical disinfection

The operator must ensure that proper decontamination is performed in case a contamination of the chamber by hazardous substances has occurred.

Disconnect the chamber from the power supply prior to chemical decontamination. Disconnect the power plug.

Do not use decontamination agents that may cause a hazard due to reaction with components of the device or the charging material. If there is doubt regarding the suitability of cleaning products, please contact BINDER service.

You can use the following disinfectants:

| | |
|---------------|--|
| Inner chamber | <p>Standard commercial surface disinfectants free from acid or halides. Alcohol based solutions. We recommend using the disinfectant spray Art. No. 1002-0022.</p> |
|---------------|--|

| | |
|---|---|
|  | <p>For chemical disinfection, we recommend using the disinfectant spray Art. No. 1002-0022. Any corrosive damage that may arise following use of other disinfectants is excluded from liability by BINDER GmbH.</p> |
|---|---|

| | |
|---|--|
|  | <p>With every decontamination / disinfection method, always use adequate personal safety controls.</p> |
|---|--|



In case of contamination of the interior by biologically or chemically hazardous material, proceed as follows:

Remove the vacuum expansion racks and removable rack holders and spray the inner chamber with an appropriate disinfectant.

If desired you can sterilize the vacuum expansion racks and removable rack holders in a sterilizer or autoclave. Before start-up, the chamber must be absolutely dry and ventilated, as explosive gases may form during the decontamination process.



| | |
|---|---|
|  | <p>In case of eye contact, the disinfectant spray may cause eye damage due to chemical burns. Follow the operating instructions and safety hints labeled on the bottle of the disinfectant spray.</p> |
|---|---|

Recommended precautions: To protect the eyes use sealed protective goggles.

| | |
|---|--|
|  |  CAUTION |
| <p>Danger of chemical burns due to eye contact with desinfectants. Eye damage. Environmental damage.</p> <ul style="list-style-type: none"> Ø Do NOT empty desinfectants into drains. ➤ Wear protective goggles. | |

| | |
|---|---|
|  | <p>After using the disinfectant spray, allow the chamber to dry thoroughly, and aerate it sufficiently.</p> |
|---|---|

26. Maintenance and service, troubleshooting, repair, testing

| | |
|---|--|
|  |  DANGER |
| <p>Fire and explosion hazard due to explosive atmosphere during maintenance and service, troubleshooting, repair, and testing.</p> <p>Serious injury or death from burns and / or explosion pressure.</p> <ul style="list-style-type: none"> ➤ Before performing troubleshooting, maintenance or repair work, make sure that there is no explosive atmosphere in the installation area of the chamber or inside the chamber Ø Do NOT perform any maintenance, repair or tests on the chamber in potentially explosive areas. ➤ Conduct the explosion protection test when performing the annual maintenance and after repair. Ø Do NOT put the chamber into operation if it did not pass the explosion protection test. ➤ Before commissioning, ensure that the system is correctly and completely grounded. | |

26.1 General information, personnel qualifications

- **Maintenance**

Please refer to chap. 26.3

- **Simple troubleshooting**

Chap. 26.2. describes troubleshooting by operating personnel. It does not require technical intervention into the chamber, nor disassembly of chamber parts

For personnel requirements please refer to chap. 1.1

- **Detailed troubleshooting**

If errors cannot be identified with simple troubleshooting, further troubleshooting must be performed by BINDER Service or by BINDER qualified service partners or technicians, in accordance with the description in the VDL Service Manual.

For personnel requirements please refer to the Service Manual.

- **Repair**

Repair of the chamber can be performed by BINDER Service or by BINDER qualified service partners or technicians, in accordance with the description in the VDL Service Manual.

After maintenance, the chamber must be **tested** prior to resuming operation. An electrical test and an explosion protection test are required.

- **Electrical testing**

To prevent the risk of electrical shock from the electrical equipment of the chamber, an annual repeat inspection as well as a test prior to initial startup and prior to resuming operation after maintenance or repair, are required. This test must meet the requirements of the competent public authorities. We recommend testing under DIN VDE 0701-0702:2008 in accordance with the details in the Service Manual.



For personnel requirements please refer to the Service Manual.

- **Test for explosion protection**

Testing before initial commissioning and before restarting after maintenance or repair as well as repeat tests according to the explosion protection concept created by the operator is required.

Observe the relevant legal regulations for the qualification of the examiner. In Germany, the explosion protection test may only be carried out by a **qualified person recognized by a state authority** or by the **manufacturer** (BINDER Service).

26.2 Simple troubleshooting

| | |
|---|---|
|  |  DANGER |
| | <p>Fire and explosion hazard due to explosive atmosphere during troubleshooting. Serious injury or death from burns and / or explosion pressure.</p> <p>➤ Before performing a simple troubleshooting, make sure that there is no explosive atmosphere in the installation area of the chamber or inside the chamber.</p> |

Defects and shortcomings can compromise the operational safety of the chamber and can lead to risks and damage to equipment and persons. If there is a technical fault or shortcoming, take the chamber out of operation and inform BINDER Service. If you are not sure whether there is a technical fault, proceed according to the following list. If you cannot clearly identify an error or there is a technical fault, please contact BINDER Service.

| | |
|---|--|
|  | <p>Only qualified service personnel authorized by BINDER must perform repair. Repaired chambers must comply with the BINDER quality standards and pass the required tests.</p> |
|---|--|



| Fault description | Possible cause | Required measures |
|---------------------------------|-----------------------------|---|
| General | | |
| Chamber permanently turned off. | No power supply. | Check connection to power supply. |
| | Wrong voltage. | Check power supply for voltage of 115V or 230V. |
| | Chamber fuse has responded. | Check chamber fuse. |
| | Controller defective. | Contact BINDER Service. |



| Fault description | Possible cause | Required measures |
|---|--|---|
| Heating | | |
| Chamber doesn't heat up. | Pressure threshold of 100 mbar not reached. No heater release. | Wait until pressure threshold is reached and heater released. Select suitable pressure setpoint. |
| | Chamber door not properly closed. | Completely close chamber door. |
| | Door gasket defective. | Replace door gasket, |
| | Pt 100 sensor defective. | Contact BINDER service. |
| | Heating element defective. | |
| | Semiconductor relay defective | |
| Chamber doesn't heat up. Alarm message "Safety controller" on the controller display | Safety controller has responded: Inner chamber temperature has reached the safety controller value. Safety controller value set too low or temperature set-point too high, or error in the heating system. | Let the chamber cool down. Acknowledge the alarm on the controller. Check the settings of the temperature setpoint and safety controller value. If appropriate, select suitable safety controller value (chap. 14.2). |
| | Safety controller defective. | Contact BINDER service. |
| Chamber doesn't heat up. Alarm message "Overtemperature" on the controller display | Safety temperature limiter (TL) has turned off the heater. Chamber defective. | Let the chamber cool down. Acknowledge the alarm on the controller and restart the chamber (re-connect power plug). If the error repeats, turn off the chamber and contact BINDER service. |
| Set-point temperature is not reached after specified time. | Chamber door not properly closed. | Completely close chamber door. |
| | Door gasket defective. | Replace door gasket, |
| | Controller not adjusted. | Calibrate and adjust controller. |
| Chamber heating permanently, set-point not maintained. | Controller defective. | Contact BINDER service |
| | Pt 100 sensor defective. | |
| | Semiconductor relay defective | |
| | Controller not adjusted. | Calibrate and adjust controller. |
| Deviations from the indicated heating-up times. | Oven fully loaded. | Charge the oven less or consider longer heating-up times. |
| Deviations from the temperature set-point in equilibrated state. | Invalid calibration | Use the delivered expansion racks only. Do NOT change between aluminum and stainless-steel racks |
| Wrong temperature value measured during calibration | Reference temperature sensor has insufficient contact to expansion rack. | Fix the reference temperature sensor with thermal conductive paste or adhesive aluminum tape. |
| | Leakage current when using a thermo element not electrically isolated. | Mount a thermo element electrically isolated from the rack. |
| Vacuum | | |
| Vacuum not held. | Door gasket defective. | Replace door gasket, |
| | Safety glass panel defective. | Replace safety glass panel. |
| | Gaskets of small flange connections (universal eccentric ring) defective. | Replace gaskets of small flange connections. |
| | Inner tube connection leaky. | Contact BINDER Service. |



| Fault description | Possible cause | Required measures |
|---|---|--|
| Controller | | |
| No chamber function (dark display). | Chamber is in standby mode. | Deactivate standby mode (chap. 9.5). |
| Menu functions not available. | Menu functions not available with current authorization level. | Log in with the required higher authorization. |
| | | Log in with the required higher authorization. or contact BINDER service to obtain an activation code (chap. 12.6). |
| No access to controller | Incorrect password. | Contact BINDER service. |
| Controller does not equilibrate to entered setpoints. | Temperature control is turned off | Turn on temperature control (chap. 11.4). |
| | Pressure control is turned off. | Turn on pressure control (chap. 11.5). |
| | Set-points were entered in Fixed value operation mode. Controller is in program operation mode. | Change to Fixed value operation mode. |
| Pressure alarm when operating without a vacuum connection. | Pressure control turned on. | Turn off pressure control (chap. 11.5). |
| Acknowledging the alarm does not cancel the alarm state. | Cause of alarm persists. | Remove cause of alarm. If the alarm state continues, contact BINDER service. |
| Alarm message: - - - - or <-<< or >>>-> | Sensor rupture between sensor and controller or Pt 100 sensor defective. | Contact BINDER service. |
| | Short-circuit. | |
| Measured-value memory cleared in Chart recorder function, information lost. | New setting of storage rate or scaling (minimum and/or maximum) (chap. 22.2). | Change the storage rate or scaling ONLY if the previously registered data are no longer required. |
| Program does not run correctly after starting it. | Pressure threshold of 100 mbar not reached. No heater release | Wait until pressure threshold is reached and heater released. Start program after this or set suitable tolerance limits. If appropriate, select suitable pressure setpoint. |
| Controller does not equilibrate to program set-points. | Controller is not in program operation mode, or program delay time is running. | Start the program again. If appropriate, wait for the program delay time. |
| Program duration longer than programmed. | Tolerances have been programmed. | For rapid transition phases, do NOT program tolerance limits in order to permit maximum heating, evacuating, or ventilation speed. |
| Program keeps the last program setpoint constant while in setting "ramp". | Program line with setting "ramp" is incomplete. | When programming with setting "ramp", define the end value of the desired cycle by adding an additional section with a section time of at least one second. |
| Ramp temperature transitions are only realized as steps. | Setting "step" has been selected. | Select setting "ramp". |

26.3 Maintenance, Service

26.3.1 Safety instructions on maintenance work

| | |
|---|---|
|  |  DANGER |
| <p>Fire and explosion hazard due to explosive atmosphere during maintenance . Serious injury or death from burns and / or explosion pressure.</p> <ul style="list-style-type: none"> ➤ Before performing maintenance work, make sure that there is no explosive atmosphere in the installation area of the chamber or inside the chamber. ⊘ Do NOT perform any maintenance or tests on the chamber in potentially explosive areas. ➤ Conduct the explosion protection test when performing the annual maintenance. ⊘ Do NOT put the chamber into operation if it did not pass the explosion protection test. ➤ Before commissioning, ensure that the system is correctly and completely grounded. | |

| | |
|---|---|
|   |  DANGER |
| <p>Electrical hazard during live maintenance work. Deadly electric shock.</p> <ul style="list-style-type: none"> ➤ Disconnect the chamber before conducting maintenance work. Pull the power plug. ⊘ Do NOT remove the rear panel of the chamber. ➤ Make sure that general maintenance work will be conducted by licensed electricians with additional skills in explosion protection (ATEX) or experts authorized by BINDER. | |

| | |
|---|---|
|  |  DANGER |
| <p>Electrical hazard due to high voltage after improper repairs. Deadly electric shock.</p> <ul style="list-style-type: none"> ➤ Make sure to perform the electrical safety test during annual maintenance and after any repairs. ⊘ Do NOT put the chamber into operation if it did not pass the electrical safety test. ➤ Have potential causes for errors checked and eliminated by servicing technicians. ➤ Make sure that general maintenance work will be conducted by licensed electricians with additional skills in explosion protection (ATEX) or experts authorized by BINDER. | |

| | |
|---|--|
|  | <p>The warranty becomes void if maintenance work is conducted by non-authorized personnel.</p> |
|---|--|

| | |
|---|---|
|  | <p>Replace the door gasket only when cold. Otherwise, the door gasket may become damaged.</p> |
|---|---|

26.3.2 Maintenance intervals

Ensure regular maintenance work is performed at least once a year and that the legal requirements are met regarding the qualifications of service personnel, scope of testing and documentation.

Calibration of the Pt 100 controller sensor and, if required, subsequent adjustment shall be performed annually during maintenance. The procedure is described in the Service manual (customer version).

An extended test of the safety temperature limiter (TL) as described in the Service manual shall be performed annually during maintenance.

Maintenance of the pump or vacuum system must be performed regularly as specified by the manufacturer. When using the VP4 pump provided by BINDER, note the information given by the pump manufacturer.

The technical ventilation (extraction) in the installation area of the chamber must also be monitored in accordance with relevant standards and regulations (for Germany: TRBS2152 Part 2).

Regular maintenance of the pump must also be carried out.

26.4 Service Reminder

After 8760 operating hours or two years the following message appears:

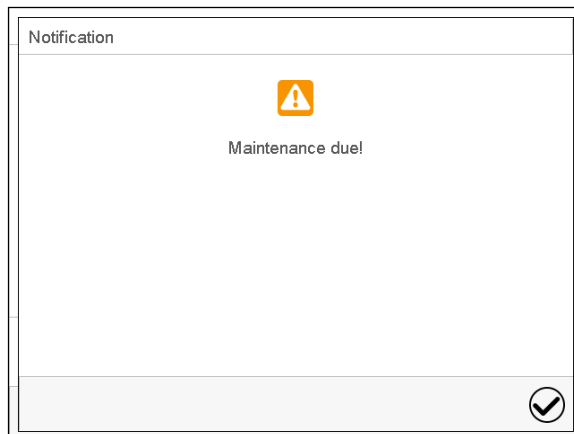

After confirmation with the **Confirm** icon, the message window will pop up again every two weeks until it is reset by BINDER Service.

26.4.1 BINDER Service contact data

We recommend taking out a maintenance agreement. Please consult BINDER Service.

| | |
|---------------------------------------|---|
| BINDER telephone hotline: | +49 (0) 7462 2005 555 |
| BINDER fax hotline: | +49 (0) 7462 2005 93555 |
| BINDER e-mail hotline: | customerservice@binder-world.com |
| BINDER service hotline USA: | +1 866 885 9794 or +1 631 224 4340 x3 (toll-free in the USA) |
| BINDER service hotline Asia Pacific: | +852 390 705 04 or +852 390 705 03 |
| BINDER service hotline Russia and CIS | +7 495 988 15 16 |
| BINDER Internet website | http://www.binder-world.com |
| BINDER address | BINDER GmbH, post office box 102, D-78502 Tuttlingen |

International customers, please contact your local BINDER distributor.

26.5 Sending the chamber back to BINDER GmbH

If you return a BINDER product to us for repair or any other reason, we will only accept the product upon presentation of an **authorization number** (RMA number) that has previously been issued to you. An authorization number will be issued after receiving your complaint either in writing or by telephone **prior** to your sending the BINDER product back to us. The authorization number will be issued following receipt of the information below:

- BINDER product type and serial number
- Date of purchase
- Name and address of the dealer from which you bought the BINDER product
- Exact description of the defect or fault
- Complete address, contact person and availability of that person
- Exact location of the BINDER product in your facility
- A contamination clearance certificate (chap. 31) must be faxed in advance

The authorization number must be applied to the packaging in such a way that it can be easily recognized or be recorded clearly in the delivery documents.



For security reasons we cannot accept a chamber delivery if it does not carry an authorization number.

Return address: BINDER GmbH, Abteilung Service, Gänsäcker 16, 78502 Tuttlingen, Germany

27. Disposal

27.1 Disposal of the transport packing



| Packing element | Material | Disposal |
|---|---|-------------------|
| Straps to fix packing on pallet | Plastic | Plastic recycling |
| Wooden transport box (option) with metal screws | Non-wood (compressed match-wood, IPPC standard) | Wood recycling |
| | Metal | Metal recycling |
| Pallet with foamed plastic stuffing | Solid wood (IPPC standard) | Wood recycling |
| | PE foam | Plastic recycling |
| Shipping box with metal clamps | Cardboard | Paper recycling |
| | Metal | Metal recycling |
| Top cover | Cardboard | Paper recycling |
| Edge protection | Styropor® or PE foam | Plastic recycling |
| Protection of doors | PE foam | Plastic recycling |
| Bag for operating manual | PE foil | Plastic recycling |
| Insulating air cushion foil (packing of optional accessories) | PE foil | Plastic recycling |

If recycling is not possible, all packing parts can also be disposed of with normal waste.

27.2 Decommissioning

- Disconnect the oven from the power supply. Disconnect the power plug.
- Turn off the inert gas supply.

When the chamber is disconnected from power supply, all solenoid valves are closed. In this condition, no inert gas can enter the vacuum drying oven and escape into the ambient air, as long as the inert gas connection with the VDL is in place.

| | |
|---|---|
|  |  DANGER |
| | <p>Risk of suffocation by inert gas in a high concentration. Death by suffocation.</p> <ul style="list-style-type: none"> ➤ Respect the relevant regulations for handling inert gases. ➤ When decommissioning the vacuum drying oven, turn off the inert gas supply. |

- Turn off the vacuum pump. Ventilate the chamber as described in chap. 9.9.1.
- Remove the vacuum connection (chap. 6.5).
- Remove the inert gas connection and the pressure reducer (chap. 6.6).

Temporal decommissioning: See indications for appropriate storage, chap. 4.3.

Final decommissioning: Dispose of the chamber as described in chap. 27.3 to 27.5.

27.3 Disposal of the chamber in the Federal Republic of Germany

According to Annex I of Directive 2012/19/EU of the European Parliament and of the Council on waste electrical and electronic equipment (WEEE), BINDER devices are classified as “monitoring and control instruments” (category 9) only intended for professional use”. They must not be disposed of at public collecting points.

The chambers bear the symbol for the marking of electrical and electronic equipment manufactured / placed on the market in the EC after 13 August 2005 and be disposed of in separate collection according to Directive 2012/19/EU on waste electrical and electronic equipment (WEEE) and German national law for electrical and electronic equipment (Elektro- und Elektronikgerätegesetz, ElektroG). WEEE marking: crossed-out wheeled bin with solid bar under. A significant part of the materials must be recycled in order to protect the environment.

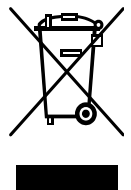



At the end of the device's service life, have the chamber disposed of according to the German national law for electrical and electronic equipment (Elektro- und Elektronikgerätegesetz, ElektroG from 20 October 2015, BGBl. I p. 1739) or contact BINDER service who will organize taking back and disposal of the chamber according to the German national law for electrical and electronic equipment (Elektro- und Elektronikgerätegesetz, ElektroG from 20 October 2015, BGBl. I p. 1739).

| | |
|---|--|
|  | NOTICE |
| | <p>Danger of violation against existing law if not disposed of properly. Failure to comply with applicable law.</p> <ul style="list-style-type: none"> ⊘ Do NOT dispose of BINDER devices at public collecting points. ➤ Have the device disposed of professionally at a recycling company which is certified according to the German national law for electrical and electronic equipment (Elektro- und Elektronikgerätegesetz, ElektroG from 20 October 2015, BGBl. I p. 1739). <li style="text-align: center;"><i>or</i> ➤ Instruct BINDER Service to dispose of the device. The general terms of payment and delivery of BINDER GmbH apply, which were valid at the time of purchasing the chamber. |

Certified companies disassemble waste (used) BINDER equipment in primary substances for recycling according to Directive 2012/19/EU. The devices must be free from toxic, infectious or radioactive substances in order to eliminate any health hazards to the employees of the recycling companies.

| | |
|---|---|
|  | <p>Prior to handing the chamber over to a recycling company, it is the user's responsibility that it is free from toxic, infectious or radioactive substances.</p> <ul style="list-style-type: none"> • Prior to disposal, clean all introduced or residual toxic substances from the chamber. • Prior to disposal, disinfect the chamber from all sources of infection. Be aware that sources of infection may also be located outside the inner chamber. • If you cannot safely remove all toxic substances and sources of infection from the chamber, dispose of it as "special" waste according to national law. • Fill out the contamination clearance certificate (chap. 31) and enclose it with the chamber. |
|---|---|

| | |
|---|--|
|  | <div style="background-color: orange; text-align: center; padding: 5px;">  WARNING </div> <p>Danger of intoxication and infection through contamination of the chamber with toxic, infectious or radioactive substances.</p> <p>Damages to health.</p> <ul style="list-style-type: none"> Ø NEVER take a chamber contaminated with toxic substances or sources of infection for recycling according to Directive 2012/19/EU. ➤ Prior to disposal, remove all toxic substances and sources of infection from the chamber. ➤ A chamber from which all toxic substances or sources of infection cannot be safely removed must be considered as "special" waste according to national law. Dispose of it accordingly. |
|---|--|

27.4 Disposal of the chamber in the member states of the EU except for the Federal Republic of Germany

According to Annex I of Directive 2012/19/EU of the European Parliament and of the Council on waste electrical and electronic equipment (WEEE), BINDER devices are classified as "monitoring and control instruments" (category 9) only intended for professional use". They must not be disposed of at public collecting points.

The chambers bear the symbol for the marking of electrical and electronic equipment manufactured / placed on the market in the EC after 13 August 2005 and be disposed of in separate collection according to the Directive 2012/19/EU on waste electrical and electronic equipment (WEEE). WEEE marking: crossed-out wheeled bin with solid bar under.

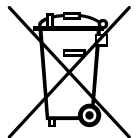



At the end of the device's service life, notify the distributor who sold you the device, who will take back and dispose of the chamber according to the Directive 2012/19/EU on waste electrical and electronic equipment (WEEE).

| | |
|---|--|
|  | <div style="background-color: blue; color: white; text-align: center; padding: 5px;"> NOTICE </div> <p>Danger of violation against existing law if not disposed of properly.</p> <p>Failure to comply with applicable law.</p> <ul style="list-style-type: none"> Ø Do NOT dispose of BINDER devices at public collecting points. ➤ Have the device disposed of professionally at a recycling company that is certified according to conversion of the Directive 2012/19/EU into national law. <li style="text-align: center;"><i>or</i> ➤ Instruct the distributor who sold you the device to dispose of it. The agreements apply that were agreed with the distributor when purchasing the chamber (e.g. his general terms of payment and delivery). ➤ If your distributor is not able to take back and dispose of the chamber, please contact BINDER service. |
|---|--|

Certified companies disassemble waste (used) BINDER equipment in primary substances for recycling according to Directive 2012/19/EU. The devices must be free from toxic, infectious or radioactive substances in order to eliminate any health hazards to the employees of the recycling companies.

| | |
|---|---|
|  | <p>Prior to handing the chamber over to a recycling company, it is the user's responsibility that it is free from toxic, infectious or radioactive substances.</p> <ul style="list-style-type: none"> • Prior to disposal, clean all introduced or residual toxic substances from the chamber. • Prior to disposal, disinfect the chamber from all sources of infection. Be aware that sources of infection may also be located outside the inner chamber. • If you cannot safely remove all sources of infection and toxic substances from the chamber, dispose of it as "special" waste according to national law. • Fill out the contamination clearance certificate (chap. 31) and enclose it with the chamber. |
|---|---|

| | |
|---|---|
|  | <div style="background-color: #FFA500; padding: 5px; text-align: center;">  WARNING </div> <p>Danger of intoxication and infection through contamination of the chamber with toxic, infectious or radioactive substances.</p> <p>Damages to health.</p> <ul style="list-style-type: none"> ⊘ NEVER take a chamber contaminated with toxic substances or sources of infection for recycling according to Directive 2012/19/EU. ➤ Prior to disposal, remove all toxic substances and sources of infection from the chamber. ➤ A chamber from which all toxic substances or sources of infection cannot be safely removed must be considered as "special" waste according to national law. Dispose of it accordingly. |
|---|---|

27.5 Disposal of the chamber in non-member states of the EU

| | |
|---|--|
|  | <div style="background-color: #00AEEF; color: white; padding: 5px; text-align: center;"> NOTICE </div> <p>Danger of violation against existing law if not disposed of properly.</p> <p>Failure to comply with applicable law. Alteration of the environment.</p> <ul style="list-style-type: none"> ➤ For final decommissioning and disposal of the vacuum drying oven, please contact BINDER Service. ➤ Follow the statutory regulations for appropriate, environmentally friendly disposal. |
|---|--|

The main board of the vacuum drying oven in the controller housing (triangular instrument box) includes a lithium cell. Please dispose of it according to national regulations.

28. Technical description

28.1 Factory calibration and adjustment

This chamber was calibrated and adjusted in the factory. Calibration and adjustment were performed using standardized test instructions, according to the QM DIN EN ISO 9001 system applied by BINDER (certified since December 1996 by TÜV CERT). All test equipment used is subject to the administration of measurement and test equipment that is also a constituent part of the BINDER QM DIN EN ISO 9001 systems. They are controlled and calibrated to a DKD-Standard at regular intervals.

Factory adjustment was done in the center of the usable volume and under vacuum conditions. The sensor is fixed in the middle of the expansion rack in a way ensuring good thermal conductivity (heat conduction). Measuring is performed in equilibrated state.

| | |
|---|--|
|  | NOTICE |
| | <p>Risk of invalid calibration due to modified heat transmission when changing between aluminum and stainless-steel racks.</p> <p>Undefined heating behavior.</p> <ul style="list-style-type: none"> ⊘ Do NOT change between aluminum and stainless-steel racks. ➤ Use the delivered expansion racks only. |

28.2 Over current protection

The chambers are protected by one or two miniature fuses against over current, accessible from the outside. The miniature fuses are located at the rear of the chamber next to the power cable connection. Each fuse holder is equipped with a fuse clip 5mm x 20 mm (cUL version 6,3x32 mm). A fuse may be replaced only with a substitute of the same ratings. Refer to the technical data of the respective device type.

28.3 VDL / VDL-UL technical data

| Chamber size | | 23 | 56 | 115 |
|---|------------|---------------|---------------|---------------|
| External dimensions | | | | |
| Vacuum drying oven | | | | |
| Width, net | mm / inch | 520 / 20.47 | 637 / 25.10 | 742 / 29.21 |
| Height, gross (including feet) | mm / inch | 720 / 28.35 | 837 / 32.95 | 964 / 37.95 |
| Depth, net | mm / inch | 490 / 19.29 | 540 / 21.26 | 660 / 25.98 |
| Depth, gross (including controller, door handle, connections, pressure regulator) | mm / inch | 632 / 24.88 | 680 / 26.77 | 801 / 31.54 |
| Window width | mm / inch | 265 / 10.43 | 380 / 14.96 | 486 / 19.13 |
| Window height | mm / inch | 265 / 10.43 | 380 / 14.96 | 486 / 19.13 |
| Pump module (option) | | | | |
| Width, net | mm / inch | 523 / 20.59 | 638 / 25.12 | 743 / 29.25 |
| Height, net | mm / inch | 705 / 27.76 | 705 / 27.76 | 705 / 27.76 |
| Depth, net | mm / inch | 491 / 19.33 | 539 / 21.22 | 659 / 25.94 |
| Depth, gross (including door handle, connections) | mm / inch | 546.5 / 21.52 | 594.5 / 23.41 | 714.5 / 28.13 |
| External dimensions | | | | |
| Chamber with optional pump module | | | | |
| Width, net | mm / inch | 523 / 20.59 | 637 / 25.10 | 742 / 29.21 |
| Height, net | mm / inch | 1425 / 56.10 | 1542 / 60.71 | 1669 / 65.71 |
| Depth, net | mm / inch | 491 / 19.33 | 540 / 21.26 | 660 / 25.98 |
| Depth, gross (including controller, door handle, connections, pressure regulator) | mm / inch | 632 / 24.88 | 680 / 26.77 | 801 / 31.54 |
| Wall clearances | | | | |
| Wall clearance, rear (minimum) | mm / inch | 100 / 3.94 | 100 / 3.94 | 100 / 3.94 |
| Wall clearance, side (minimum) | mm / inch | 70 / 2.76 | 70 / 2.76 | 70 / 2.76 |
| Internal dimensions | | | | |
| Width | mm / inch | 285 / 11.22 | 400 / 15.75 | 506 / 19.92 |
| Height | mm / inch | 285 / 11.22 | 400 / 15.75 | 506 / 19.92 |
| Depth | mm / inch | 295 / 11.61 | 343 / 13.50 | 460 / 18.11 |
| Interior volume | l / cu.ft. | 24 / 0.85 | 55 / 1.94 | 119 / 4.20 |

| Chamber size | | 23 | 56 | 115 | |
|---|--------------------------------|---|----------------------------|----------------------------|----------------------------|
| Racks | | | | | |
| Number of expansion racks (aluminum), series | | 2 | 2 | 2 | |
| Number of expansion racks (aluminum), max. | | 4 | 5 | 6 | |
| Distance between the racks | | mm / inch | 53 / 2.09 | 62 / 2.44 | 68 / 2.68 |
| Usable space per rack (width x depth) | | mm / inch | 234 x 280 9.21 x 11.02 | 349 x 320 13.74 x 12.60 | 455 x 440 17.91 x 17.32 |
| Permissible load per rack | | Kg / lbs | 20 / 44 | 20 / 44 | 20 / 44 |
| Permissible total load | | Kg / lbs | 50 / 110 | 60 / 132 | 70 / 154 |
| Weight | | | | | |
| Weight (empty) | | Kg / lbs | 72 / 159 | 104 / 229 | 158 / 348 |
| Temperature data | | | | | |
| Temperature range | degrees above room temperature | °C / °F | 9 / 16.2 | 9 / 16.2 | 9 / 16.2 |
| | up to | °C / °F | 110 / 230 | 110 / 230 | 110 / 230 |
| Temperature fluctuation at 100 °C / 212 °F | | ± K | 0.1 | 0.1 | 0.1 |
| Temperature uniformity (variation) at 100 °C / 212 °F | | ± K | 1.0 | 1.2 | 2.9 |
| Heating up time to 100 °C / 212 °F | | Min | 110 | 140 | 170 |
| Vacuum data | | | | | |
| Vacuum connection with small flange | | DN mm / inch | 16 | 16 | 16 |
| Measuring access port with small flange | | DN mm / inch | 16 | 16 | 16 |
| Inert gas connection with flow-limiter Adapter with hose olive | | ∅ mm / inch | 8 | 8 | 8 |
| Vacuum range (adjustable) | | mbar / inHg | 10 to 1100 | 10 to 1100 | 10 to 1100 |
| Leak rate | | bar/h / inHg/h | 1x10 ⁻² / 0.295 | 1x10 ⁻² / 0.295 | 1x10 ⁻² / 0.295 |
| Ex Classification | | | | | |
| Ex-Classification of the entire chamber according to ATEX Directive 2014/34/EU | |  II 2/3/- G IIB T3 Gb/Gc/- X | | | |
| Electrical data (model versions VDL023-230V, VDL056-230V, VDL115-230V) | | | | | |
| Protection type according to EN 60529 - MB2 controller housing | | IP | 20 | 20 | 20 |
| Protection type, VDL general (type plate) | | IP | 20 | 20 | 20 |
| Nominal voltage (+/-10%) | at 50 Hz power frequency | V | 200-230 | 200-230 | 200-230 |
| | at 60 Hz power frequency | V | 200-230 | 200-230 | 200-230 |
| Current type | | | 1N~ | 1N~ | 1N~ |
| Nominal power | | kW | 0,90 | 1,40 | 1,60 |
| Nominal current | | A | 3,9 | 6,1 | 7,0 |
| Chamber fuse 5 x 20 mm / 250V / time-lag T | | A | 2 x 6,3 | 2 x 8 | 2 x 10 |
| Power plug | | | Grounded plug | | |
| Over-voltage category acc. to IEC 61010-1 | | | II | II | II |
| Pollution degree acc. to IEC 61010-1 | | | 2 | 2 | 2 |
| Different electrical data for VD-UL constructed for the USA and Canada (model versions VDL023UL-120V, VDL056UL-120V, VDL115UL-120V) | | | | | |
| Nominal voltage (+/-10%) | at 50 Hz power frequency | V | 100-120 | 100-120 | 100-120 |
| | at 60 Hz power frequency | V | 100-120 | 100-120 | 100-120 |
| Nominal current | | A | 7,5 | 11,7 | 13,4 |
| Chamber fuse 5 x 20 mm / 250V / time-lag T | | A | 10 | 2 x 16 | -- |
| Chamber fuse 6.3 x 32 mm / 250V / time-lag T | | A | -- | -- | 2 x 20 |
| Power plug | | NEMA | 5-15P | 5-20P | 5-20P |

| Chamber size | | 23 | 56 | 115 |
|---------------------------------------|--------|-----|-----|-----|
| Environment-specific data | | | | |
| VDL noise level (mean value) | dB (A) | 40 | 40 | 40 |
| Energy consumption at 100 °C / 212 °F | Wh/h | 140 | 180 | 230 |

All technical data is specified for unloaded chambers with standard equipment (with aluminum racks) at an ambient temperature of +22 °C +/- 3 °C / 71.6 °F +/- 5.4 °F and a power supply voltage fluctuation of +/- 10 %. Technical data is determined in accordance to BINDER Factory Standard Part 2:2015 and DIN 12880:2007.

All indications are average values, typical for chambers produced in series. We reserve the right to change technical specifications at any time.

28.4 Equipment and options (extract)



To operate the VDL vacuum drying oven, use only original BINDER accessories or accessories / components from third-party suppliers authorized by BINDER. The user is responsible for any risk arising from using unauthorized accessories.

| Regular equipment |
|---|
| Microprocessor display program controller MB2 with touch screen |
| Ethernet interface for computer communication |
| USB interface |
| Safety controller (safety device class 2 according to DIN 12880:2007) |
| Universal connection for inert gas / ambient air "GAS/AIR", adapter with 8 mm hose olive, with solenoid valve for inert gas / ambient air |
| Pressure regulator (rear) for sweeping with compressed air |
| Analog pressure display (manometer) for sweeping with compressed air |
| Pressure switch for heating release at 100 mbar |
| Measuring connection (DN 16), rear |
| 2 vacuum expansion racks |
| Safety glass panel |

| Options / accessories | | |
|--|-------------------|-----------|
| Expansion racks , aluminum or stainless steel 1.4571 | | |
| Lockable door | | |
| Analog outputs 4-20 mA for temperature and pressure | | |
| Additional universal connection for inert gas / ambient air „GAS/AIR 2“, adapter with 8 mm hose olive, with solenoid valve for inert gas / ambient air | | |
| Additional universal access port 40 mm | | |
| FKM door gasket (temperature resistant up to 150 °C / 302 °F) | | |
| Object temperature display with flexible Pt 100 temperature sensor | | |
| APT-COM™ 4 Multi Management Software for logging and display of temperature data and networking up to 100 chambers with PC | | |
| ATEX connection kit for VP4 vacuum pump with various small flange parts | | |
| Pump module | | |
| Chemical membrane pump VP4 with separator and emission condenser | | |
| • Ready to connect: Suction power | m ³ /h | 1,9 |
| • End vacuum | mbar | 12 |
| • Electrical connection (50-60 Hz) | V | 120 / 230 |

| Options / accessories |
|---|
| Factory calibration certificate |
| Extension to factory calibration certificate (additional value) |
| Calibration certificate of object temperature display |
| Calibration certificate of pressure display |
| Extension to factory calibration certificate (additional value) of pressure display |
| Qualification folder |
| Evaporating dish, small or large |
| Stable table on wheels with castors and locking brakes |

28.5 Accessories and spare parts (extract)

| | |
|---|--|
|  | BINDER GmbH is responsible for the safety features of the chamber only, provided skilled electricians or qualified personnel authorized by BINDER perform all maintenance and repair, and if components relating to chamber safety are replaced in the event of failure with original spare parts. The user is responsible for any risks arising from using unauthorized accessories/components. |
|---|--|

Failure to follow these instructions can result in loss of explosion protection.

| Chamber size | 23 | 56 | 115 |
|--|-----------|-----------|-----------|
| Description | Art. no. | | |
| Expansion rack, aluminum | 8009-1031 | 8009-1030 | 8009-1029 |
| Expansion rack, stainless steel | 8009-1093 | 8009-1092 | 8009-1091 |
| Exchange of aluminum expansion racks for stainless steel, calibration included | 8012-1955 | 8012-1956 | 8012-1957 |
| Silicon door gasket, temperature-resistant up to 200 °C / 392 °F | 6005-0290 | 6005-0291 | 6005-0292 |
| FKM door gasket, temperature-resistant up to 150 °C / 302 °F, acid-resistant, silicon free | 8012-0502 | 8012-0501 | 8012-0500 |
| Chamber fuse 5 x 20 mm / 250V / time lag T for VDL 230 V | 5006-0092 | 5006-0093 | 5006-0079 |
| Chamber fuse 5 x 20 mm / 250V / time lag T for VDL 23-UL, VD 56-UL | 5006-0079 | 5006-0103 | --- |
| Chamber fuse 6,3 x 32 mm / 250V / time lag T for VDL 115-UL | --- | --- | 5006-0030 |
| Safety glass panel | 6012-0012 | 6012-0013 | 6012-0014 |
| Rack holder | 6004-0230 | 6004-0229 | 6004-0211 |
| Pump module | 8012-1948 | 8012-1949 | 8012-1950 |

| Description | Art. no. |
|--|-----------|
| Accessory kit, consisting of: | 8009-0070 |
| Copper seal ring | 6005-0056 |
| Hose olive | 6009-0064 |
| Universal centering ring | 6009-0048 |
| Straining ring | 6009-0009 |
| Blind flange | 6009-0010 |
| Door handle, complete | 6002-0541 |
| Stable table on wheels with castors and locking brakes | 9051-0018 |
| Evaporating dish, small | 4022-0125 |
| Evaporating dish, large | 4022-0126 |
| Vacuum pump VP 4 (230V) | 5013-0049 |
| Vacuum pump VP 4 (120V) | 5013-0118 |
| Connection kit for vacuum pump VP4 | 8012-0621 |
| Neutral cleaning agent, 1 kg | 1002-0016 |

| Validation service | Art. No. |
|---|-----------|
| Qualification folder IQ-OQ (printed version) | 7007-0001 |
| Qualification folder IQ-OQ (digital version) | 7057-0001 |
| Qualification folder IQ-OQ-PQ (printed version) | 7007-0005 |
| Qualification folder IQ-OQ-PQ (digital version) | 7057-0005 |
| Execution of IQ-OQ | DL420300 |
| Execution of IQ-OQ-PQ | DL440500 |

| Calibration service | Art. no. |
|---|-----------|
| Calibration of temperature including certificate (1 measuring point) | 8012-1145 |
| Spatial temperature measurement including certificate (9 measuring points) | 8012-0916 |
| Spatial temperature measurement including certificate (15 measuring points) | 8012-0919 |
| Calibration of pressure including certificate | 8012-0440 |

For information on components not listed here, please contact BINDER Service.

28.6 Dimensions

28.6.1 VDL 23

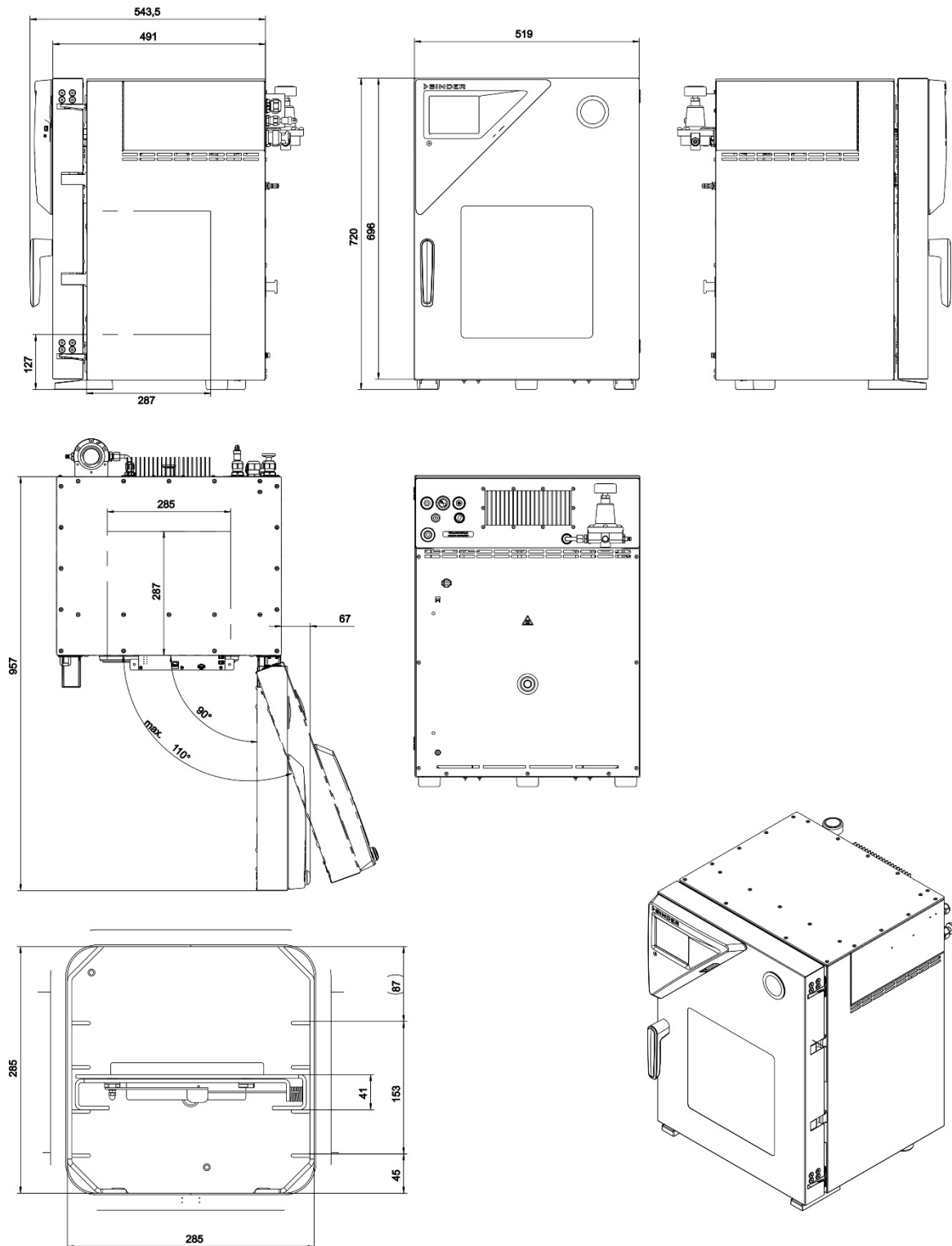

(Dimensions in mm)

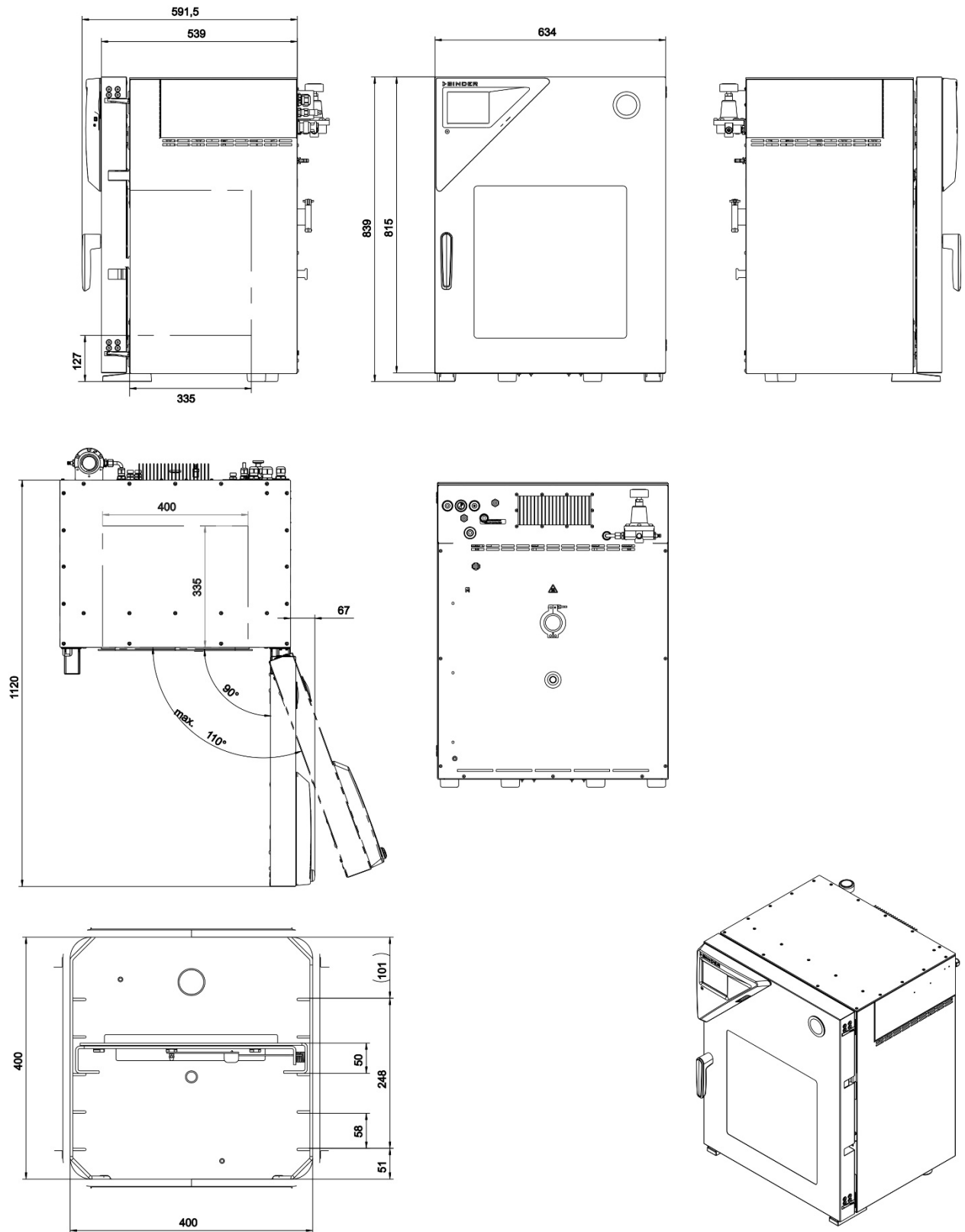
28.6.2 VDL 56

(Dimensions in mm)

28.6.3 VDL 115

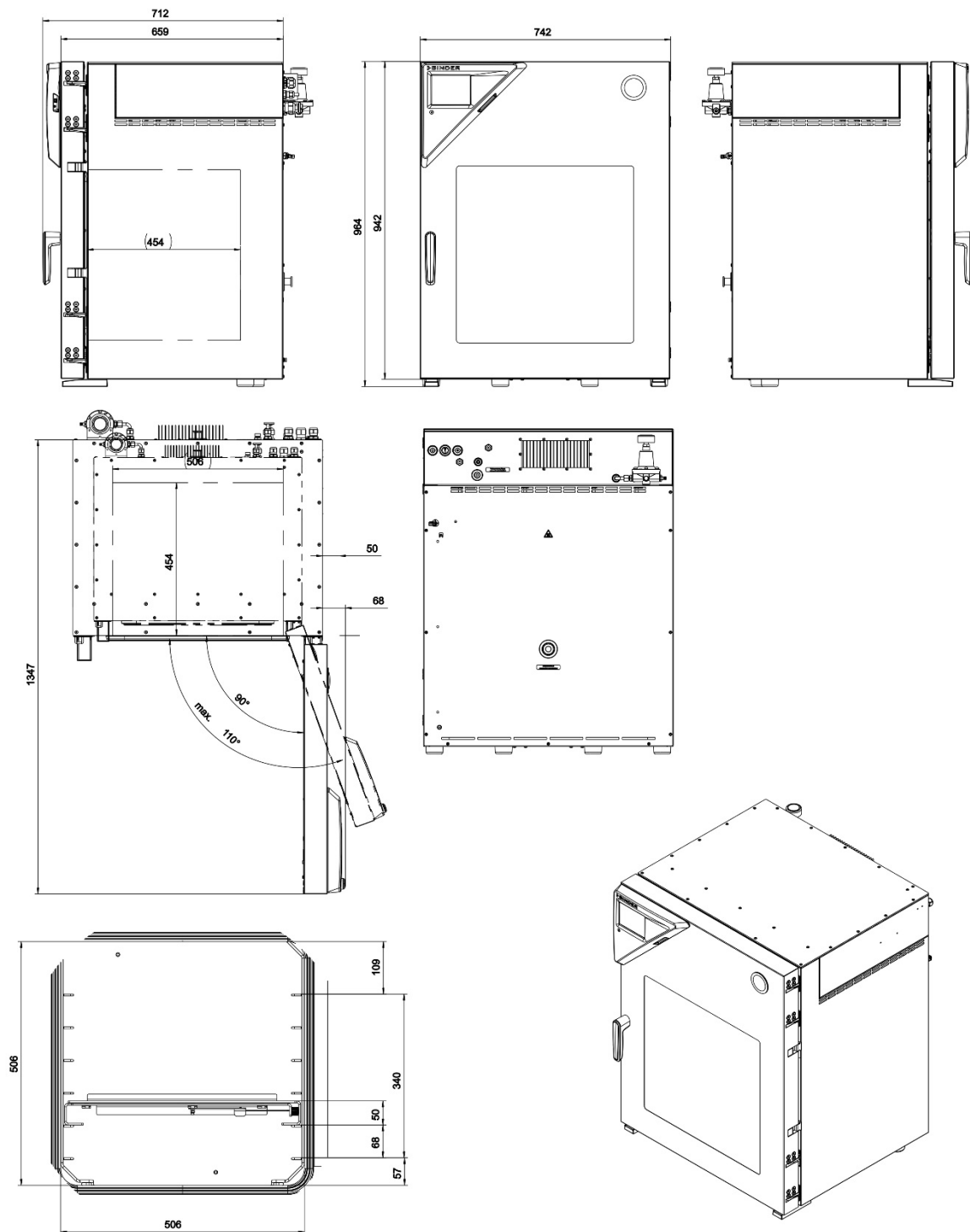

(Dimensions in mm)

29. Index

- Activation code 113
- Ambient temperature 52
- Analog output 161
- Analog outputs 44, 50
- Area classification 26, 44, 47
- Audible alarm 126
- Auto-ignition temperature 18, 19, 22, 26, 33, 34, 35, 37, 38, 60, 62, 63, 84, 85, 91, 92, 95, 96, 97, 129, 131, 143
- Cleaning 164
- Commissioning 70, 71
- Compressed air supply 16, 21, 27, 30, 44, 52, 54, 56, 84, 85, 86, 160
- Compressed air sweeping 16, 21, 22, 24, 25, 27, 44, 46, 56, 84, 85, 86, 87, 88, 160
- Condensate catchpot 18, 27, 39, 51, 85, 96
- Connection kit 59, 64, 179, 181
- Corrosion 53, 61, 63
- Domestic vacuum system 59
- Drying monitoring 103
- Drying monitoring 85
- Dust 15, 19, 26, 50, 92
- Emergency ventilation 44, 48, 82, 93, 94
- Equipotential bonding 27, 38, 40, 52, 66, 67, 91
- Equipotential bonding 84
- ESD 20, 27, 28, 32, 33, 39, 52, 66, 68, 85, 91, 95, 96
- Ethernet 36, 44, 46, 50, 161, 179
- Ex classification 13, 36
- Exothermic reactions 26
- Expansion rack 180
- Expansion racks 37, 53, 54, 165, 166, 178, 179
- Explosion group 19, 26
- Explosion hazard 8, 15, 16, 17, 18, 19, 21, 50, 51, 53, 56, 58, 60, 61, 62, 63, 70, 92, 94, 95, 97, 129, 131, 143, 161, 162
- Explosion protection document 32, 71
- Explosion protection plan 14, 32, 33, 70, 71
- Explosion protection symbol 10, 13
- Extraction 18, 27, 39, 50, 51, 91, 95, 96, 172
- Fire extinguisher 52
- Flame arrester 64
- Foreseeable misuse 34
- Foreseeable Misuse 28
- Fuse 177
- Gas group 19, 26
- Gas inlet temperature 18, 60, 62, 63
- GAS/AIR 44, 93, 100, 179
- Gloves 28, 33, 39, 72, 91, 96
- Grounding concept 15, 66, 84
- Grounding plan 27, 38, 40, 91
- Heater release 38
- Heating release 179
- Ignition source monitoring 37, 120
- Inert gas 21, 22, 51, 62, 63, 64, 65, 93, 100, 174
- Inert gas connection 64
- Instrument box 42, 155
- Intended use 25
- interface 179
- Interface 36, 42, 44, 161, 163
- Labels 12
- Lightning protection device 52
- Loading area 20, 39, 51, 52, 92
- Maintenance 35, 171, 172
- Manual ventilation 44, 48, 93, 94
- Measuring connection 42, 162, 179
- Medical devices 27
- Object temperature display 44, 162, 163
- Object temperature input 162
- Operating instructions 28, 29, 33, 34
- Overheating 15
- Password protection 91, 105
- Personal protective equipment 28, 32, 33, 52, 66, 68, 91, 95, 96
- Personal protective equipment 20
- Plug 44, 48, 93, 94
- PPE 20, 27, 33, 52, 66, 68, 72, 91, 95, 96
- Pressure threshold 85

Pump module 21, 38, 39, 47, 48, 50, 52, 56, 59, 61, 62, 63, 66, 68, 70, 177, 179, 180

Rack holder 180

Rack holders 53

Residual risks 30, 34

Risk assessment 32

safety alert symbol 10

Safety controller 22, 35, 40, 83, 84, 96, 119, 121, 169, 179

Safety glass panel 40, 180

Safety glass window 41

Safety pressure monitoring 38

Safety temperature 91

SOP 34

Stacking 50

Standard Operating Procedures 34

Standby 84, 89, 91, 99, 140

Technical ventilation 16, 18, 19, 21, 22, 27, 39, 46, 49, 50, 51, 59, 72, 73, 83, 84, 88, 89, 91, 95, 96, 172

Temperature class 13, 18, 19, 26, 36, 60, 62, 63

Termination of the drying process 34, 94

Tests 71, 73

tolerance range 83

Tolerance range 122

Transport 49

TRGS 725 72, 73

Type plate 13, 26, 28, 36, 40, 69

Unpacking 48

USB 36, 42, 155, 179

Vacuum connection 44, 59

Vacuum pump 17, 47, 50, 52, 59, 60, 61, 62, 63, 64, 66, 70, 181

Vacuum supply 17

Zone 15, 17, 21, 25, 27, 28, 44, 50, 59, 62, 63, 64

Zone classification 44

30. Certificates and declarations of conformity

30.1 EU Declaration of Conformity



Best conditions for your success

| | |
|---|---|
|  | EU-Konformitätserklärung / EU Declaration of Conformity / Déclaration de conformité UE / Declaración de conformidad UE / Dichiarazione di conformità UE / Декларация соответствия EU |
| Hersteller / Manufacturer / Fabricant / Fabricante / Fabricante / Производитель | BINDER GmbH |
| Anschrift / Address / Adresse / Dirección / Endereço / Адрес | Im Mittleren Ösch 5, 78532 Tuttlingen, Germany |
| Produkt / Product / Produit / Producto / Prodotto / Продукт | Vakuumentrockenschränke für entflammable Lösungsmittel Vacuum drying ovens for flammable solvents Etuves de séchage à vide pour les solvants inflammables Estufas de secado al vacío para disolventes inflamables Stufe a vuoto per solventi infiammabili Вакуумные сушильные шкафы для воспламеняющихся растворителей |
| Typenbezeichnung / Type / Type / Tipo / Tipo / Тип | VDL 23, VDL 56, VDL 115 (E3.1) |
| Art. No. / Art. no. / Réf. / Art. N° / Art. n. / № арт. | 9630-0009, 9630-0010, 9630-0011, 9630-0013, 9630-0014, 9630-0015 |

Die oben beschriebenen Maschinen sind konform mit folgenden EG/EU-Richtlinien (gemäß Veröffentlichung im Amtsblatt der europäischen Kommission):

The machines described above are in conformity with the following EC/EU Directives (as published in the Official Journal of the European Union):

Les machines décrites ci-dessus sont conformes aux directives CE/UE suivantes (selon leur publication dans le Journal officiel de l'Union européenne):

La máquina descrita arriba cumple con las siguientes directivas de la CE/UE (publicados en el Diario oficial de la Unión Europea):

Le macchine sopra descritte sono conforme alle seguenti direttive CE/UE (secondo la pubblicazione nella Gazzetta ufficiale della Commissione europea):

Машина, указанная выше, полностью соответствует следующим регламентам ЕС/ЕУ (опубликованным в Официальном журнале Европейского Содружества):

- **2006/42/EC**
Maschinenrichtlinie 2006/42/EG / Machinery directive 2006/42/EC / Directive Machines 2006/42/EC / Directiva 2006/42/CE (Máquinas) / Direttiva macchine 2006/42/CE / Директива о машинах 2006/42/EC
- **2014/34/EU**
ATEX-Richtlinie 2014/34/EU / ATEX Directive 2014/34/EU / Directive ATEX 2014/34/UE / Directiva ATEX 2014/34/UE / Direttiva ATEX 94/9/UE / Директива ATEX 2014/34/EU
- **2014/30/EU**
EMV-Richtlinie 2014/30/EU / EMC Directive 2014/30/EU / Directive CEM 2014/30/UE / Directiva CEM 2014/30/UE / Direttiva EMC 2014/30/UE / Директива ЭМС 2014/30/EU
- **2011/65/EU**
RoHS-Richtlinie 2011/65/EU / RoHS Directive 2011/65/EU / Directive RoHS 2011/65/UE / Directiva RoHS 2011/65/UE / Direttiva RoHS 2011/65/UE / Директива RoHS 2011/65/EU

1 / 3

BINDER GmbH Postfach 102 D-78502 Tuttlingen **Anschrift:** BINDER GmbH Im Mittleren Ösch 5 D-78532 Tuttlingen
Kontakt: Telefon: +49 (0) 74 62 / 20 05 - 0 | Telefax: +49 (0) 74 62 / 20 05 - 100 | info@binder-world.com | www.binder-world.com
Geschäftsführung: Dipl.-Ing. Peter M. Binder | Amtsgericht Stuttgart, HRB 727150 | Sitz der Gesellschaft: Tuttlingen
Bankverbindung: Kreissparkasse Tuttlingen Konto-Nr.: 2266 BLZ: 643 500 70 | IBAN-Code: DE05643 500700 000002266 | SWIFT-Code: SOLA DE S1TUT
 S-Account 2202 611 55 | IBAN-Code: DE7464350070 0220 261155 | SWIFT-Code: SOLA DE S1TUT
 Deutsche Bank Tuttlingen Konto-Nr.: 2 138 709 BLZ: 653 700 75 | IBAN-Code: DE56653 70075 0213870900 | SWIFT-Code: DEUT DE SS603
 Altgeräte-Entsorgung gemäß WEEE-Reg.-Nr. DE 37004983

Die oben beschriebenen Maschinen entsprechen aufgrund ihrer Konzipierung und Bauart sowie in der von uns in Verkehr gebrachten Ausführung den einschlägigen grundlegenden Sicherheits- und Gesundheitsanforderungen der genannten EG/EU-Richtlinien.

The machines described above are conform to the mentioned EC/EU directives in regard to the relevant safety and health demands due to their conception and style of construction as well as to the version put onto market by us.

Les machines décrites ci-dessus correspondent aux demandes de sécurité et de santé des directives citées de la CE/UE due à leur conception et construction et dans la réalisation mise sur le marché par nous.

Las máquinas descritas arriba se corresponden con los requisitos básicos pertinentes de seguridad y salud de las citadas directivas de la CE/UE debido a su concepción y fabricación, así como a la realización llevada a cabo por nosotros.

Le macchine sopra descritte sono conforme ai requisiti essenziali di sanità e sicurezza pertinenti delle summenzionate direttive CE/UE in termini di progettazione, tipo di costruzione ed esecuzione messa da noi in circolazione.

Машины описано выше, соответствует указанным директивам ЕС/ЕУ в отношении требований соответствующей безопасности и здоровья по концепции и конструкции так же как и версия, применяемая нами на рынке.

Die oben beschriebenen Maschinen tragen entsprechend die Kennzeichnung CE.

The machines described above, corresponding to this, bear the CE-mark.

Les machines décrits ci-dessus, en correspondance, portent l'indication CE.

Las máquinas descritas arriba, en conformidad, llevan la indicación CE.

Le macchine sopra descritte sono contrassegnate dal marchio CE.

Машины описано выше, в соответствии с изложенным выше маркированы знаком CE.

Die oben beschriebenen Maschinen sind konform mit folgenden harmonisierten Normen:

The machines described above are in conformity with the following harmonized standards:

Les machines décrits ci-dessus sont conformes aux normes harmonisées suivantes:

Las máquinas descritas arriba cumplen con las siguientes normas:

Le macchine sopra descritte sono conforme alle seguenti normative armonizzate:

Машины описано выше, полностью соответствуют следующим стандартам:

| |
|---|
| Sicherheit / Safety / Sécurité / Seguridad / Sicurezza / Нормативы по безопасности |
| <ul style="list-style-type: none"> • EN ISO 12100:2010 • EN ISO 13732-1:2008 • EN 60204-1:2018 |
| EMV / EMC / CEM / CEM / EMC / ЭМС |
| <ul style="list-style-type: none"> • EN 61326-1:2013 |
| RoHS |
| <ul style="list-style-type: none"> • EN 50581:2012 |

2 / 3

BINDER GmbH Postfach 102 D-78502 Tuttlingen **Anschrift:** BINDER GmbH Im Mittleren Ösch 5 D-78532 Tuttlingen
Kontakt: Telefon: +49 (0) 74 62 / 20 05 - 0 | Telefax: +49 (0) 74 62 / 20 05 - 100 | info@binder-world.com | www.binder-world.com
Geschäftsführung: Dipl.-Ing. Peter M. Binder | Amtsgericht Stuttgart, HRB 727150 | Sitz der Gesellschaft: Tuttlingen
Bankverbindung: Kreissparkasse Tuttlingen Konto-Nr.: 2266 BLZ: 643 500 70 | IBAN-Code: DE05643 500700 000002266 | SWIFT-Code: SOLA DE S1TUT
S-Account 2202 611 55 | IBAN-Code: DE7464350070 0220 261155 | SWIFT-Code: SOLA DE S1TUT
Deutsche Bank Tuttlingen Konto-Nr.: 2 138 709 BLZ: 653 700 75 | IBAN-Code: DE56653 70075 0213870900 | SWIFT-Code: DEUT DE SS603
 Altgeräte-Entsorgung gemäß WEEE-Reg.-Nr. DE 37004983

Explosionsschutz / Explosion protection / Protection contre les explosions / Protección contra explosiones /
Protezione contro le esplosioni / Взрывозащита

- EN 1127-1:2011
- EN 60079-2:2014
- EN 60079-11:2012
- EN ISO 80079-36:2016
- EN ISO 80079-37:2016

Die Ex-Klassifikation des Gesamtgerätes (Baugruppe) nach ATEX Richtlinie 2014/34/EU ist :

The Ex classification of the entire unit (assembly) according to ATEX Directive 2014/34/EU is :

La classification Ex de l'appareil entier (assemblage) selon la Directive 2014/34/UE ATEX est :

La clasificación Ex del dispositivo completo (ensamblaje) según la Directiva 2014/34/UE es:

La classificazione Ex dello spazio interno dell'intero apparecchio (assemblaggio) secondo la direttiva ATEX 2014/34/UE è:

Классификация Ex внутренней всей камеры (сборка) в соответствии с Директивой ATEX 2014/34/EU

 II 2/3/- G IIB T3 Gb/Gc/- X

Die Temperaturklasse des Gerätes nach EN 60079-0 ist T3.

The temperature class of the entire unit acc. to EN 60079-0 is T3.

La classe de température de l'appareil entier selon EN 60079-0 est T3.

La clase de temperatura del dispositivo completo es T3.

La classe di temperatura dell'intero apparecchio secondo EN 60079-0 è T3.

Класс температурной защиты всей камеры в соответствии с EN 60079-0 – T3.

78532 Tuttlingen, 25.03.2020

BINDER GmbH



P. M. Binder
Geschäftsführender Gesellschafter
Managing Director
Directeur général
Director general
Direttore Generale
Директор



J. Bollaender
Leiter F & E
Director R & D
Chef de service R&D
Responsable I & D
Direttore R & D
Глава департамента R&D

3 / 3

BINDER GmbH Postfach 102 D-78502 Tuttlingen **Anschrift:** BINDER GmbH Im Mittleren Ösch 5 D-78532 Tuttlingen
Kontakt: Telefon: +49 (0) 74 62 / 20 05 - 0 | Telefax: +49 (0) 74 62 / 20 05 - 100 | info@binder-world.com | www.binder-world.com
Geschäftsführung: Dipl.-Ing. Peter M. Binder | Amtsgericht Stuttgart, HRB 727150 | Sitz der Gesellschaft: Tuttlingen
Bankverbindung: Kreissparkasse Tuttlingen Konto-Nr.: 2266 BLZ: 643 500 70 | IBAN-Code: DE05643 500700 000002266 | SWIFT-Code: SOLA DE S1TUT
S-Account 2202 611 55 | IBAN-Code: DE7464350070 0220 261155 | SWIFT-Code: SOLA DE S1TUT
Deutsche Bank Tuttlingen Konto-Nr.: 2 138 709 BLZ: 653 700 75 | IBAN-Code: DE56653 70075 0213870900 | SWIFT-Code: DEUT DE SS603
Altgeräte-Entsorgung gemäß WEEE-Reg.-Nr. DE 37004983

30.2 Certificate for the GS mark of conformity of the “Deutsche Gesetzliche Unfallversicherung e.V.” (German Social Accident Insurance) DGUV

Zertifikat
Nr. **NV 20231**
vom 23.11.2020

 **DGUV Test**
Prüf- und Zertifizierungsstelle
Nahrungsmittel und Verpackung
Fachbereich Nahrungsmittel

GS-Zertifikat

| | |
|---|--|
| Name und Anschrift des Zertifikatsinhabers: (Auftraggeber) | Binder GmbH Im Mittleren Ösch 5 78532 Tuttlingen |
| Produktbezeichnung: | Vakuumtrockenschrank |
| Typ: | VDL (E3.1), VDL 23, VDL 56, VDL 115 |
| Prüfgrundlage: | GS-NV 2:2019/08 Prüfgrundsätze für Nahrungsmittelmachines |
| Zugehöriger Prüfbericht: | Prüfbericht zum Zertifikat NV 20231 |
| Weitere Angaben: | Das Zertifikat bezieht sich auf die im zugehörigen Prüfbericht beschriebene Ausführung des Produkts. |

Das geprüfte Baumuster stimmt mit den in § 21 Absatz 1 des Produktsicherheitsgesetzes genannten Anforderungen überein. Der Zertifikatsinhaber ist berechtigt, das umseitig abgebildete GS-Zeichen an den mit dem geprüften Baumuster übereinstimmenden Produkten anzubringen. Der Zertifikatsinhaber hat dabei die umseitig aufgeführten Bedingungen zu beachten.

Dieses Zertifikat einschließlich der Berechtigung zur Anbringung des GS-Zeichens ist gültig bis einschließlich:

22.11.2025

Weiteres über die Gültigkeit, eine Gültigkeitsverlängerung und andere Bedingungen regelt die Prüf- und Zertifizierungsordnung.



Rückseite GS-Zertifikat: NV 20231

GS-Zeichen



NV 20231

Normalausführung



NV 20231

dguv.de/dguv-test

Bei einer Höhe von 20 mm oder weniger
auch zulässige Ausführung

1. Der Zertifikatsinhaber hat die Voraussetzungen einzuhalten, die bei der Herstellung des umseitig genannten Produktes zu beachten sind, um die Übereinstimmung mit dem geprüften Baumuster zu gewährleisten.
2. Die Prüf- und Zertifizierungsstelle des Fachbereichs Nahrungsmittel führt in regelmäßigen Abständen Kontrollmaßnahmen zur Überwachung der Herstellung und rechtmäßigen Verwendung des GS-Zeichens durch.
3. Die für die Herstellung verantwortliche Person hat sich zur Einhaltung der Voraussetzungen nach Nummer 1 und Duldung der Kontrollmaßnahmen verpflichtet.
4. Die Prüf- und Zertifizierungsstelle entzieht dem Zertifikatsinhaber die Zuerkennung des GS-Zeichens, wenn sich die Anforderungen nach § 21 Absatz 1 Produktsicherheitsgesetz geändert haben oder die Voraussetzungen nach Nummer 1 nicht eingehalten werden.
5. Das GS-Zeichen darf nur verwendet und mit ihm darf nur geworben werden, wenn die Voraussetzungen nach § 22 Produktsicherheitsgesetz erfüllt sind.

31. Contamination clearance certificate

31.1 For chambers located outside USA and Canada

Declaration regarding safety and health

Erklärung zur Sicherheit und gesundheitlichen Unbedenklichkeit

The German Ordinance on Hazardous Substances (GefStofV), and the regulations regarding safety at the workplace, require that this form be filled out for all products that are returned to us, so that the safety and the health of our employees can be guaranteed.

Die Sicherheit und Gesundheit unserer Mitarbeiter, die Gefahrstoffverordnung GefStofV und die Vorschriften zur Sicherheit am Arbeitsplatz machen es erforderlich, dass dieses Formblatt für alle Produkte, die an uns zurückgeschickt wird.



Note: A repair is not possible without a completely filled out form.
Ohne Vorliegen des vollständig ausgefüllten Formblattes ist eine Reparatur nicht möglich.

- A completely filled out form must be transmitted via Fax (+49 (0) 7462 2005 93555) or by letter in advance, so that this information is available before the equipment/component part arrives. A second copy of this form must accompany the equipment/component part. In addition, the carrier should be notified.

Eine vollständig ausgefüllte Kopie dieses Formblattes soll per Telefax (Nr. +49 (0) 7462 2005 93555) oder Brief vorab an uns gesandt werden, so dass die Information vorliegt, bevor das Gerät/Bauteil eintrifft. Eine weitere Kopie soll dem Gerät/Bauteil beigelegt sein. Ggf. ist auch die Spedition zu informieren.

- Incomplete information or non-conformity with this procedure will inevitably lead to substantial delays in processing. Please understand the reason for this measure, which lies outside our area of influence, and will help us to speed up this procedure.

Unvollständige Angaben oder Nichteinhalten dieses Ablaufs führen zwangsläufig zu beträchtlichen Verzögerungen in der Abwicklung. Bitte haben Sie Verständnis für Maßnahmen, die außerhalb unserer Einflussmöglichkeiten liegen und helfen Sie mit, den Ablauf beschleunigen.

- Please print and fill out this form completely.

Bitte unbedingt vollständig ausfüllen!

| | |
|------------|---|
| 1. | Unit/ component part / type: / Gerät / Bauteil / Typ: |
| 2. | Serial No. / Serien-Nr.: |
| 3. | Details about utilized substances / biological substances / Einzelheiten über die eingesetzten Substanzen/biologische Materialien: |
| 3.1 | Designations / Bezeichnungen: |
| a) | _____ |
| b) | _____ |
| c) | _____ |
| 3.2 | Safety measures required for handling these substances / Vorsichtsmaßnahmen beim Umgang mit diesen Stoffen: |
| a) | _____ |
| b) | _____ |
| c) | _____ |

| | |
|--------------------------|---|
| 3.3 | Measures to be taken in case of skin contact or release into the atmosphere / Maßnahmen bei Personenkontakt oder Freisetzung: |
| a) | _____ |
| b) | _____ |
| c) | _____ |
| d) | _____ |
| 3.4 | Other important information that must be taken into account / Weitere zu beachtende und wichtige Informationen: |
| a) | _____ |
| b) | _____ |
| c) | _____ |
| 4. | Declaration on the risk of these substances (please checkmark the applicable items) / Erklärung zur Gefährlichkeit der Stoffe (bitte Zutreffendes ankreuzen): |
| <input type="checkbox"/> | 4.1 For non-toxic, non-radioactive, biologically harmless materials / für nicht giftige, nicht radioaktive, biologisch ungefährliche Stoffe: We hereby guarantee that the above-mentioned unit / component part... / Wir versichern, dass o.g. Gerät/Bauteil... |
| <input type="checkbox"/> | Has not been exposed to or contains any toxic or otherwise hazardous substances / weder giftige noch sonstige gefährliche Stoffe enthält oder solche anhaften. |
| <input type="checkbox"/> | That eventually generated reaction products are non-toxic and also do not represent a hazard / auch evtl. entstandene Reaktionsprodukte weder giftig sind noch sonst eine Gefährdung darstellen. |
| <input type="checkbox"/> | Eventual residues of hazardous substances have been removed / evtl. Rückstände von Gefahrstoffen entfernt wurden. |
| <input type="checkbox"/> | 4.2 For toxic, radioactive, biologically harmful or hazardous substances, or any other hazardous materials / für giftige, radioaktive, biologisch bedenkliche bzw. gefährliche Stoffe oder anderweitig gefährliche Stoffe. We hereby guarantee that ... / Wir versichern, dass ... |
| <input type="checkbox"/> | The hazardous substances, which have come into contact with the above-mentioned equipment/component part, have been completely listed under item 3.1 and that all information in this regard is complete / die gefährlichen Stoffe, die mit dem o.g. Gerät/Bauteil in Kontakt kamen, in 3.1 aufgelistet sind und alle Angaben vollständig sind. |
| <input type="checkbox"/> | That the unit /component part has not been in contact with radioactivity / das Gerät/Bauteil nicht mit Radioaktivität in Berührung kam |
| 5. | Kind of transport / transporter / Transportweg/Spediteur: Transport by (means and name of transport company, etc.) / Versendung durch (Name Spediteur o.ä.) _____ Date of dispatch to BINDER GmbH / Tag der Absendung an BINDER GmbH: _____ |

We hereby declare that the following measures have been taken / Wir erklären, dass folgende Maßnahmen getroffen wurden:

- Hazardous substances were removed from the unit including component parts, so that no hazard exists for any person in the handling or repair of these items / das Gerät/Bauteil wurde von Gefahrstoffen befreit, so dass bei Handhabung/Reparaturen für die betreffenden Person keinerlei Gefährdung besteht
- The unit was securely packaged and properly identified / das Gerät wurde sicher verpackt und vollständig gekennzeichnet.
- Information about the hazardousness of the shipment (if required) has been provided to the transporter / der Spediteur wurde (falls vorgeschrieben) über die Gefährlichkeit der Sendung informiert.

We hereby commit ourselves and guarantee that we will indemnify BINDER GmbH for all damages that are a consequence of incomplete or incorrect information provided by us, and that we will exempt BINDER GmbH from eventual damage claims by third parties. / Wir versichern, dass wir gegenüber BINDER für jeden Schaden, der durch unvollständige und unrichtige Angaben entsteht, haften und BINDER gegen eventuell entstehende Schadenansprüche Dritter freistellen.

We are aware that, in accordance with Article 823 of the German Civil Code (BGB), we are directly liable with regard to third parties, in this instance especially the employees of BINDER GmbH, who have been entrusted with the handling / repair of the unit / component. / Es ist uns bekannt, dass wir gegenüber Dritten – hier insbesondere mit der Handhabung/Reparatur des Geräts/des Bauteils betraute Mitarbeiter der Firma BINDER – gemäß §823 BGB direkt haften

Name: _____

Position/Title: _____

Date / Datum: _____

Signature / Unterschrift: _____

Company stamp / Firmenstempel:



Equipment that is returned to the factory for repair must be accompanied by a completely filled out contamination clearance certificate. For service and maintenance on site, such a contamination clearance certificate must be submitted to the service technician before the start of any work. No repair or maintenance of the equipment is possible, without a properly filled out contamination clearance certificate.

31.2 For chambers located in USA and Canada

Product Return Authorization Request

Please complete this form and the Customer Decontamination Declaration (next 2 pages) and attach the required pictures. E-mail to: IDL_SalesOrderProcessing_USA@binder-world.com

After we have received and reviewed the complete information we will decide on the issue of a RMA number. Please be aware that size specifications, voltage specifications as well as performance specifications are available on the internet at www.binder-world.us at any time.

Take notice of shipping laws and regulations.

| | | |
|--|--|--|
| | Please fill: | |
| Reason for return request | <input type="radio"/> Duplicate order | |
| | <input type="radio"/> Duplicate shipment | |
| | <input type="radio"/> Demo | <i>Page one completed by sales</i> |
| | <input type="radio"/> Power Plug / Voltage | 115V / 230 V / 208 V / 240V |
| | <input type="radio"/> Size does not fit space | |
| | <input type="radio"/> Transport Damage | Shock watch tripped? (<i>pictures</i>) |
| | <input type="radio"/> Other (specify below) | |
| | _____ | |
| Is there a replacement PO? | <input type="radio"/> Yes <input type="radio"/> No | |
| <i>If yes -> PO #</i> | | |
| <i>If yes -> Date PO placed</i> | | |
| | | |
| Purchase order number | | |
| BINDER model number | | |
| BINDER serial number | | |
| Date unit was received | | |
| | | |
| Was the unit unboxed? | <input type="radio"/> Yes <input type="radio"/> No | |
| Was the unit plugged in? | <input type="radio"/> Yes <input type="radio"/> No | |
| Was the unit in operation? | <input type="radio"/> Yes <input type="radio"/> No | |
| | | |
| <i>Pictures of unit attached?</i> | <input type="radio"/> Yes <input type="radio"/> No | Pictures have to be attached! |
| <i>Pictures of Packaging attached?</i> | <input type="radio"/> Yes <input type="radio"/> No | |

| | Customer Contact Information | Distributor Contact Information |
|---------|------------------------------|---------------------------------|
| Name | | |
| Company | | |
| Address | | |
| Phone | | |
| E-mail | | |

Customer (End User) Decontamination Declaration

Health and Hazard Safety declaration

To protect the health of our employees and the safety at the workplace, we require that this form is completed by the user for all products and parts that are returned to us. (Distributors or Service Organizations cannot sign this form)

| | |
|---|---|
|  | <p>NO RMA number will be issued without a completed form. Products or parts returned to our NY warehouse without an RMA number will be refused at the dock.</p> |
|---|---|

A second copy of the completed form must be attached to the outside of the shipping box.

| | |
|------------|---|
| 1. | Unit/ component part / type: |
| 2. | Serial No. |
| 3. | List any exposure to hazardous liquids, gasses or substances and radioactive material |
| 3.1 | List with MSDS sheets attached where available or needed (if there is not enough space available below, please attach a page): |
| a) | _____ |
| b) | _____ |
| c) | _____ |
| 3.2 | Safety measures required for handling the list under 3.1 |
| a) | _____ |
| b) | _____ |
| c) | _____ |
| 3.3 | Measures to be taken in case of skin contact or release into the atmosphere: |
| a) | _____ |
| b) | _____ |
| c) | _____ |
| d) | _____ |
| 3.4 | Other important information that must be considered: |
| a) | _____ |
| b) | _____ |
| c) | _____ |

4. Declaration of Decontamination

For toxic, radioactive, biologically and chemically harmful or hazardous substances, or any other hazardous materials.

We hereby guarantee that

- 4.1 Any hazardous substances, which have come into contact with the above-mentioned equipment / component part, have been completely listed under item 3.1 and that all information in this regard is complete.
- 4.2 That the unit /component part has not been in contact with radioactivity
- 4.3 Any Hazardous substances were removed from the unit / component part, so that no hazard exists for a person in the shipping, handling or repair of these returned unit
- 4.4 The unit was securely packaged in the original undamaged packaging and properly identified on the outside of the packaging material with the unit designation, the RMA number and a copy of this declaration.
- 4.5 Shipping laws and regulations have not been violated.

I hereby commit and guarantee that we will indemnify BINDER Inc. for all damages that are a consequence of incomplete or incorrect information provided by us, and that we will indemnify and hold harmless BINDER Inc. from eventual damage claims by third parties.

Name: _____

Position: _____

Company: _____

Address: _____

Phone #: _____

Email: _____

Date: _____

Signature: _____



Equipment returned to the NY warehouse for repair must be accompanied by a completed customer decontamination declaration. For service and maintenance works on site, such a customer decontamination declaration must be submitted to the service technician before the start of work. No repair or maintenance of the equipment is possible without a completed form.