

NIST on a Chip: Revolution in Measurement Services

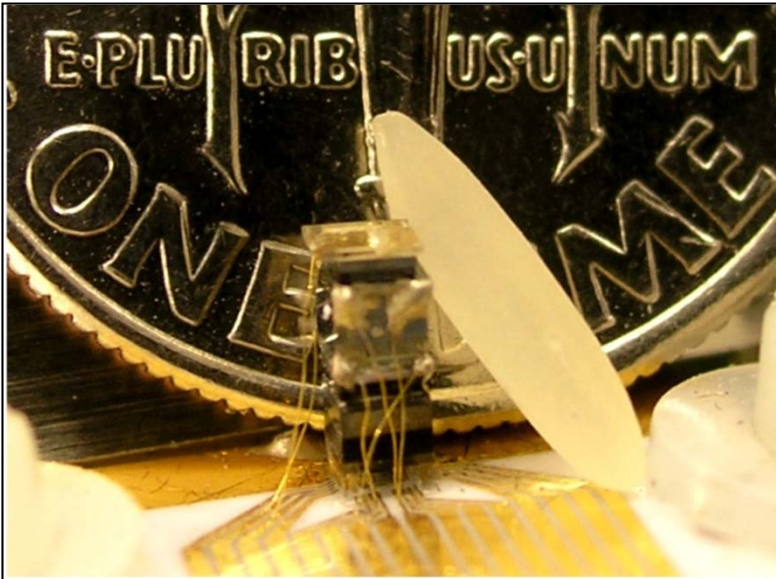

...And Measurement Science

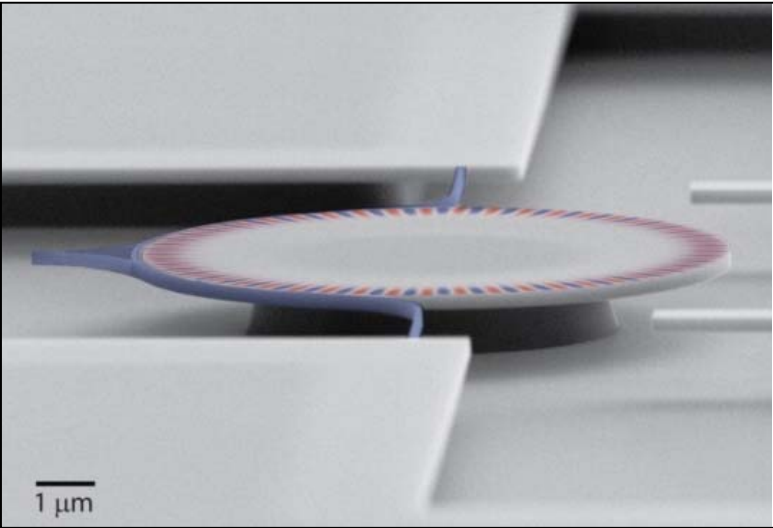
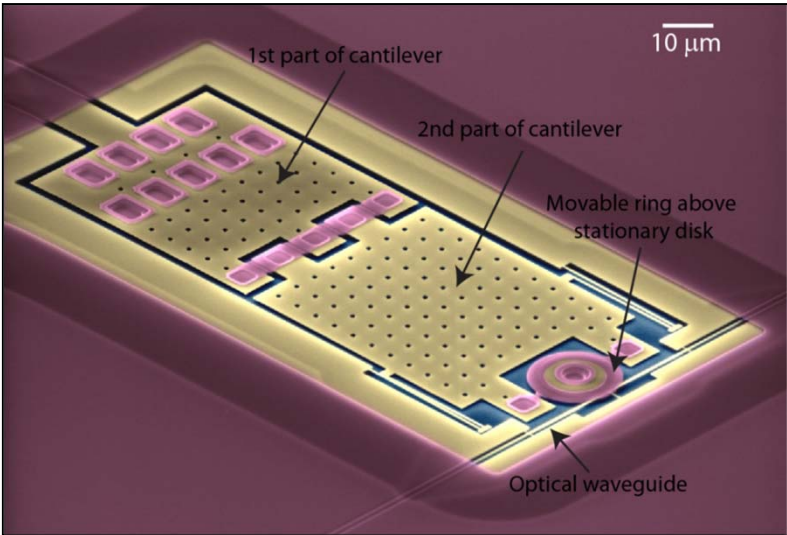

What is NIST on a Chip?

An integrated program to develop and deploy NIST-traceable measurements and physical standards that:

- Are deployed in the customer's lab / factory floor / device / system.
- Easily used and integrated.
 - Small size and weight, low power consumption, rugged.
- Provide a broad range of measurements and standards relevant to the particular customer needs / applications.
 - One, few, or many measurements from a single small form package.
- Are manufacturable.
 - Potential for production costs low enough to enable broad deployment.

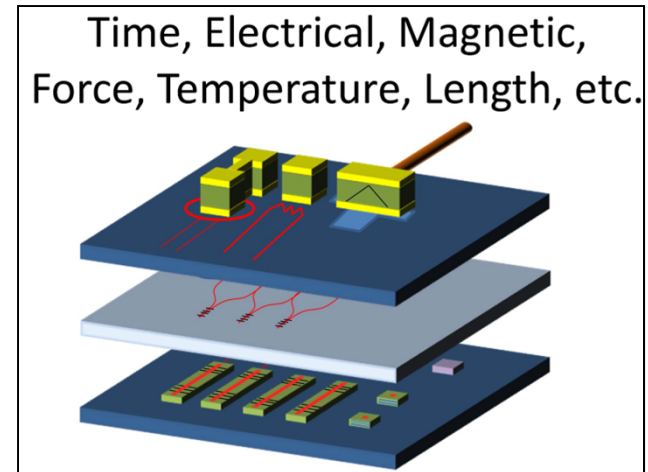

What is NIST on a Chip?

Free NIST precision measurements and physical standards from the NIST lab and directly provide them to the customer / user.



Time, Electrical, Magnetic,
Force, Temperature, Length, etc.

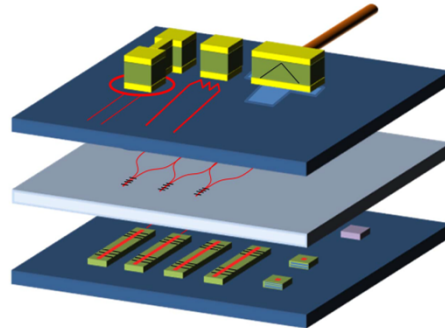

What is NIST on a Chip?

New applications enabled by small size, low power, intrinsic standard...

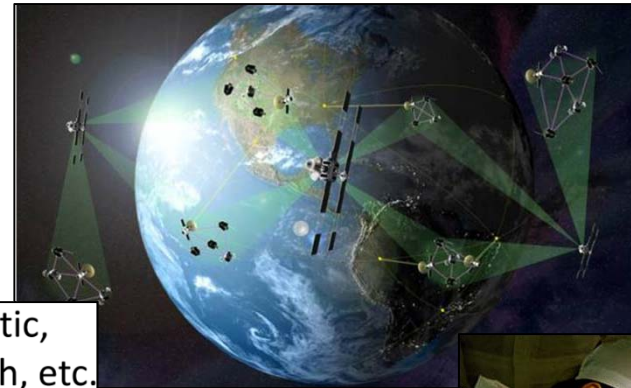

Time, Electrical, Magnetic, Force, Temperature, Length, etc.

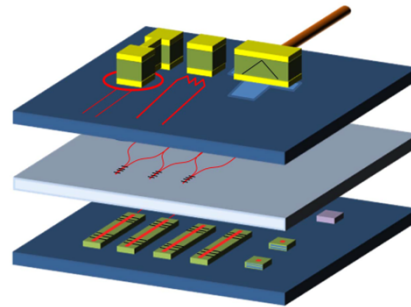

Traditional Measurement Services vs. NIST on a Chip

NIST measurements

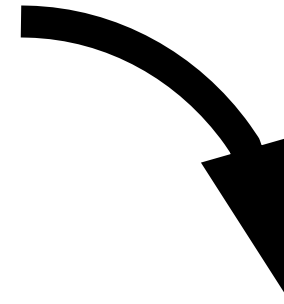

Device shipped
to customer

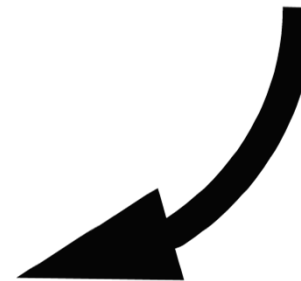

Customer needs
calibration/measurement
of device

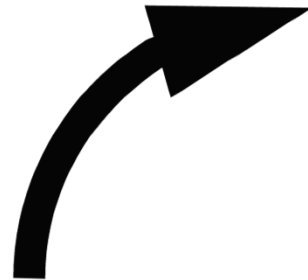

Device shipped
to NIST

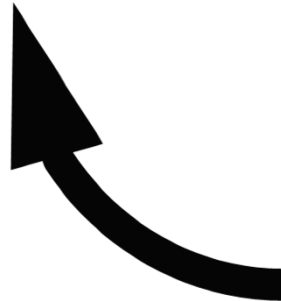

Traditional Measurement Services vs. NIST on a Chip

NIST provides critical measurement needs as efficiently and effectively as possible through traditional measurement services.

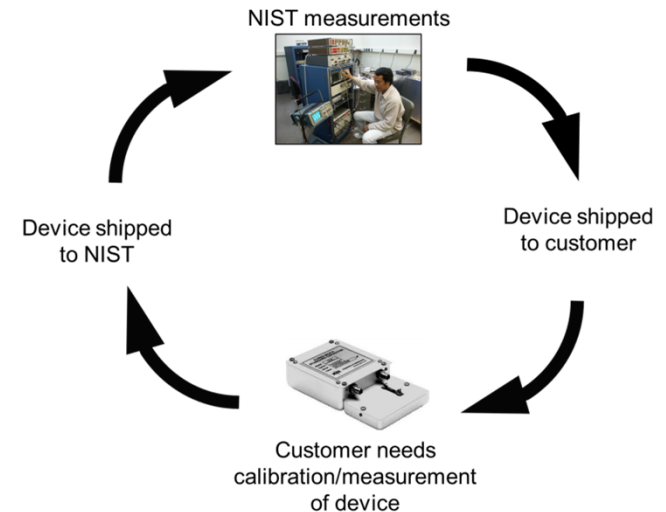

But some limitations of the traditional model include:

- Significant down time for customer's standard or device.
 - Customer must have back-up standards/devices, or accept down-time.
 - Standard/device cannot be easily deployed on factory floor / systems.
- Expensive NIST staff time and administrative burden.
- Periodic recalibrations.
 - Customer cannot be certain standard/device remains in calibration specifications.
- Range of available calibrations/measurements may be limited and relatively inflexible compared to changing customer needs.

Traditional Measurement Services vs. NIST on a Chip

With NIST on a Chip:

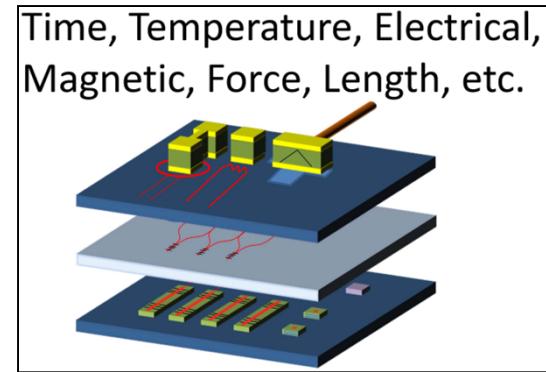

- Customer has NIST-traceable standard in lab / on factory floor / in operating device or system 24/7/365.
- No need for periodic recalibration so standard is always in service (in most cases).
- Potential for much broader and more flexible range of measurements and standards.

How Realistic is NIST on a Chip?

Substantial proof-of-principle measurement science and initial demonstrations already exist:

- Are deployed in the customer's lab / factory floor / device / system.
- Easily used and integrated.
 - Small size and weight, low power consumption, rugged.
- Provide a broad range of measurements and standards relevant to the particular customer needs / applications.
 - One, few, or many measurements from a single small form package.
- Are manufacturable.
 - Potential for production costs low enough to enable broad deployment.

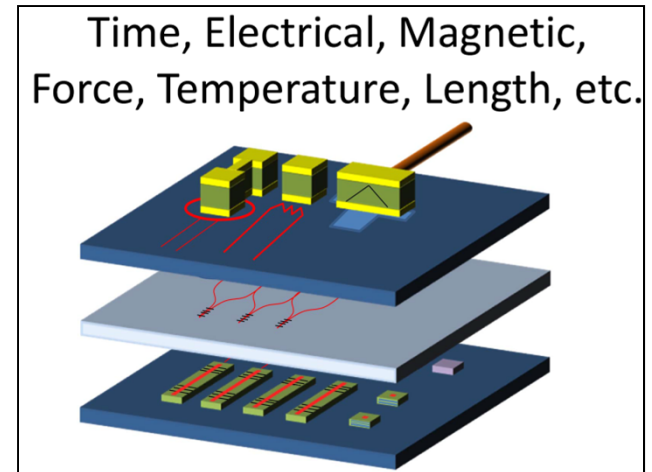

Remotely Deployed Measurement Services and Standards



10^{-14} uncertainty
NIST time and
frequency in
customer's lab

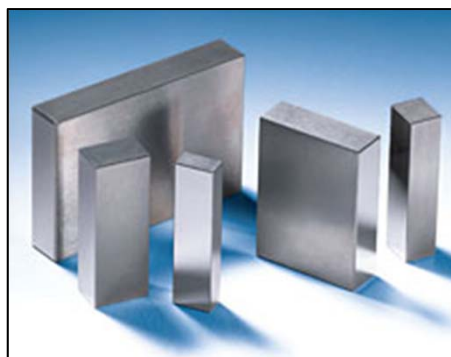
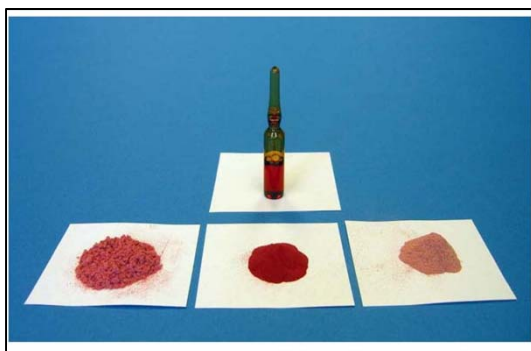

Standard Reference Materials

NIST on a Chip – Roughly analogous to “active SRM.”

How Realistic is NIST on a Chip?

Substantial proof-of-principle already exists:

- Are deployed in the customer's lab / factory floor / device / system.
- Easily used and integrated.
 - Small size and weight, low power consumption, rugged.
- Provide a broad range of measurements and standards relevant to the particular customer needs / applications.
 - One, few, or many measurements from a single small form package.
- Are manufacturable.
 - Potential for production costs low enough to enable broad deployment.

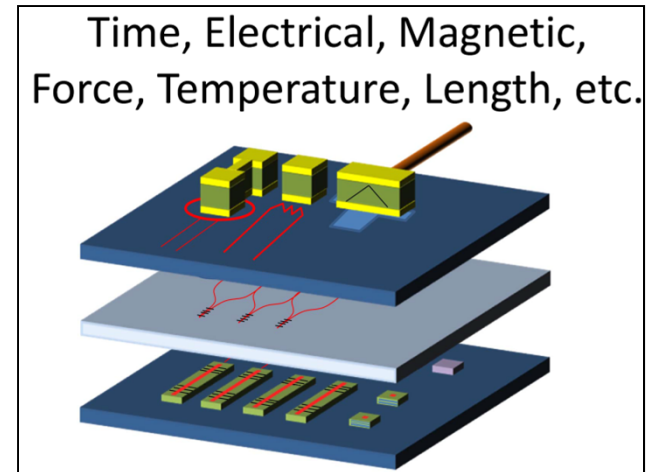

NIST Chip-Scale Devices

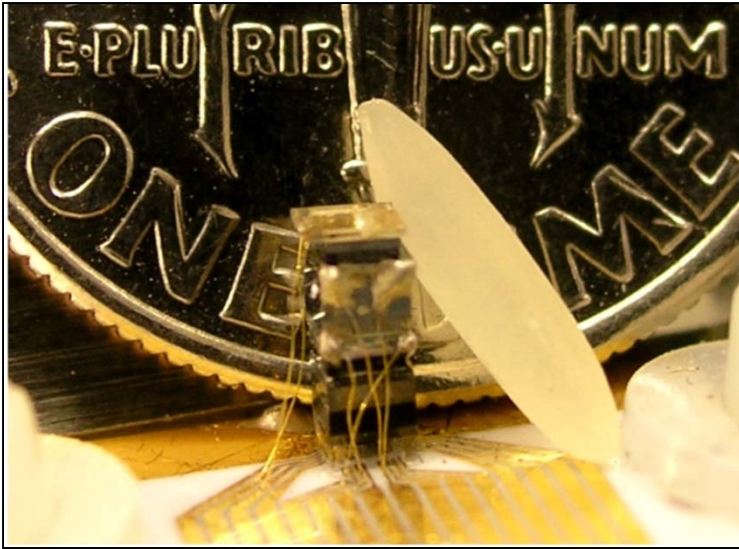

NIST chip-scale atomic clocks and magnetometers.

Atomically precise measurements.

AA battery power (~ 0.01 W).

NIST Josephson quantum voltage standard.

Intrinsic (quantum-based) standard.

$\sim 300,000$ junctions.

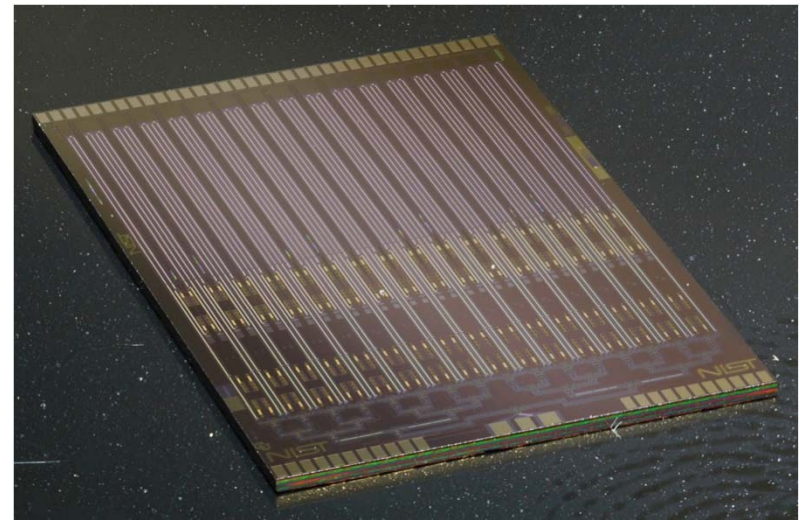

How Realistic is NIST on a Chip?

Substantial proof-of-principle measurement science and initial demonstrations already exist:

- Are deployed in the customer's lab / factory floor / device / system.
- Easily used and integrated.
 - Small size and weight, low power consumption, rugged.
- Provide a broad range of measurements and standards relevant to the particular customer needs / applications.
 - One, few, or many measurements from a single small form package.
- Are manufacturable.
 - Potential for production costs low enough to enable broad deployment.

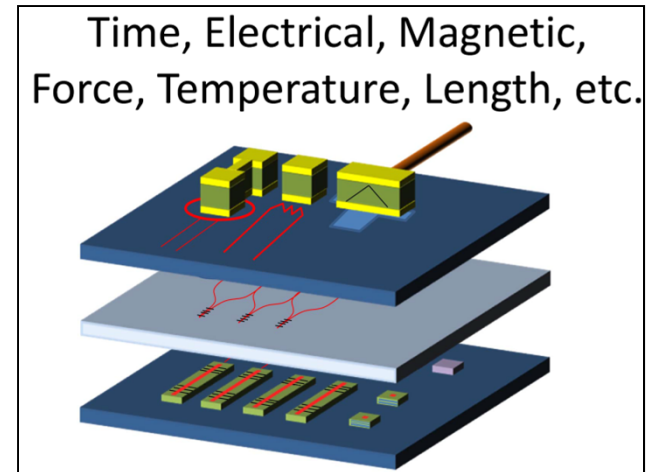

NIST on a Chip Measurement Technologies

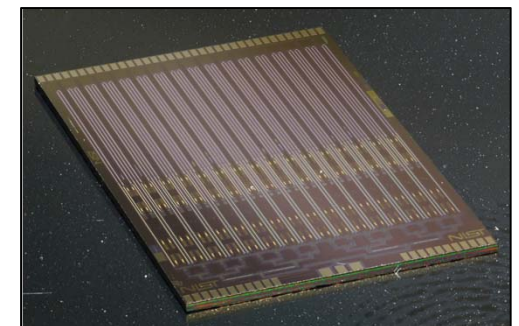
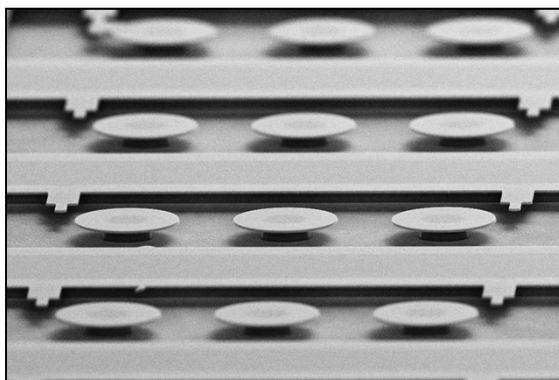
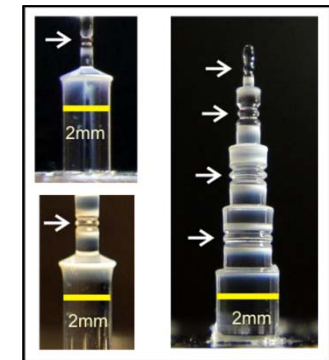
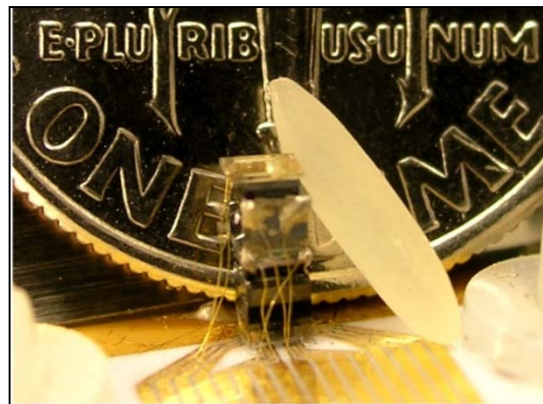
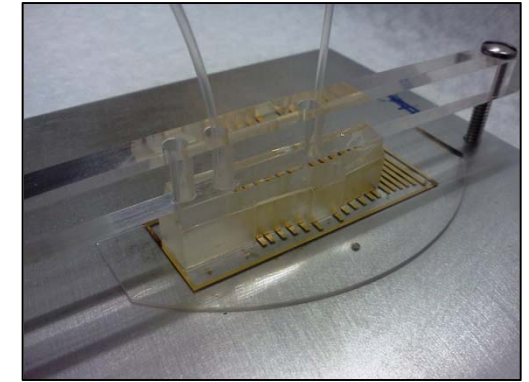
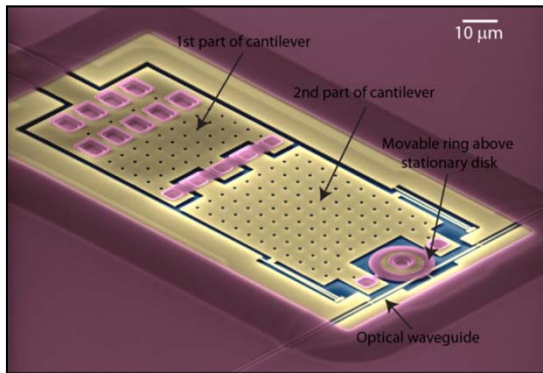

- Force
- Fluid flow
- Pressure
- Length
- Voltage
- Current
- Magnetic field
- Time and frequency
- Optical power
- Displacement
- Electric field
- More...

How Realistic is NIST on a Chip?

Substantial proof-of-principle measurement science and initial demonstrations already exist:

- Are deployed in the customer's lab / factory floor / device / system.
- Easily used and integrated.
 - Small size and weight, low power consumption, rugged.
- Provide a broad range of measurements and standards relevant to the particular customer needs / applications.
 - One, few, or many measurements from a single small form package.
- Are manufacturable.
 - Potential for production costs low enough to enable broad deployment.

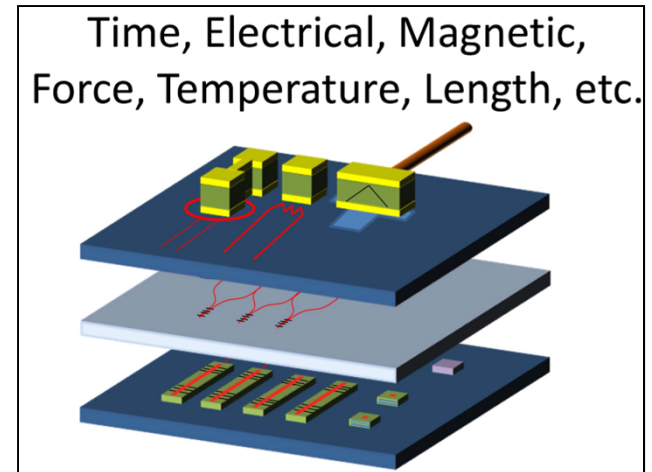

Manufacturability

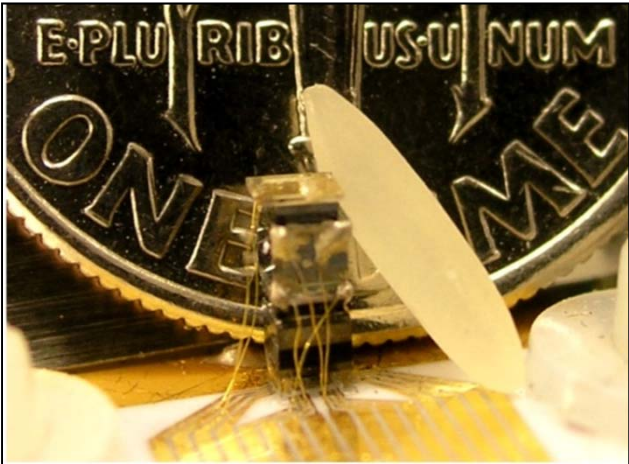

NIST Chip-scale atomic clock



Commercial chip-scale atomic clock

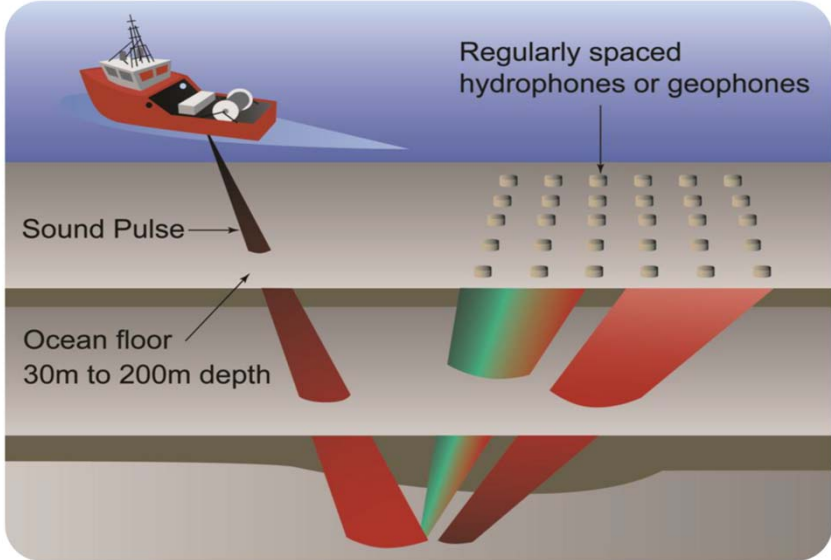

Commercial CSAC built into third party commercial applications

How Realistic is NIST on a Chip?

Substantial proof-of-principle measurement science and initial demonstrations already exist:

- Remote deployment.
- Small size, low power, rugged.
- Broad range of measurements.
- Manufacturability.
- Demonstration of all these capabilities, but mostly in early stages with limited integration.

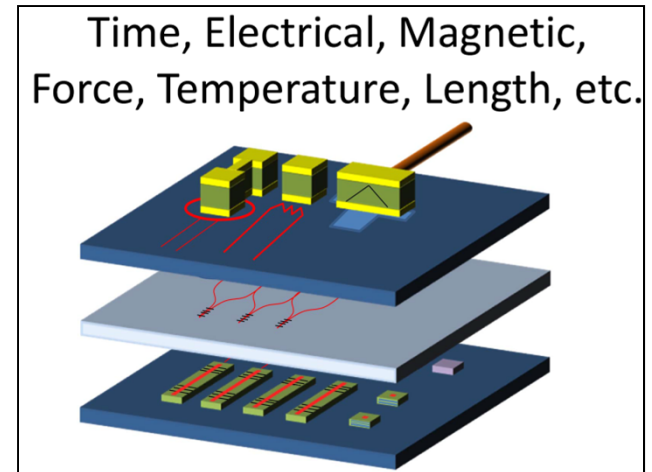

Substantially more work needed for:

- Fundamental measurement science.
- Integration of multiple measurement technologies.
- Manufacturability.

Likelihood of continuing success is high, with sufficient resources, planning, coordination, and external partnering.

“Lab on a Chip”

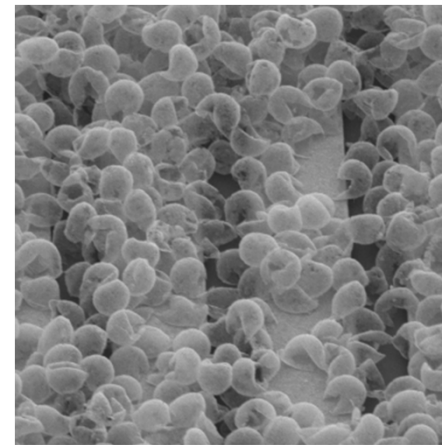
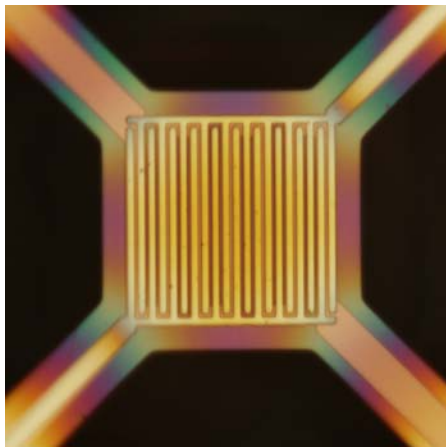
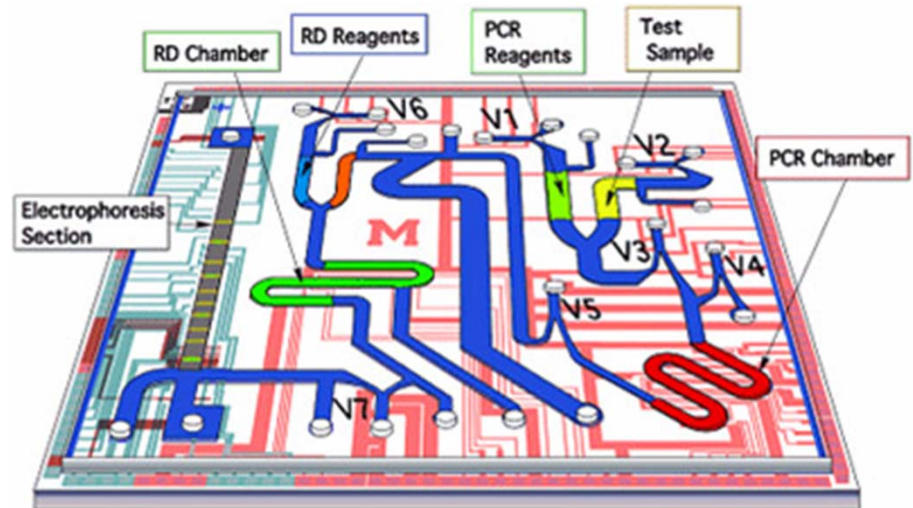
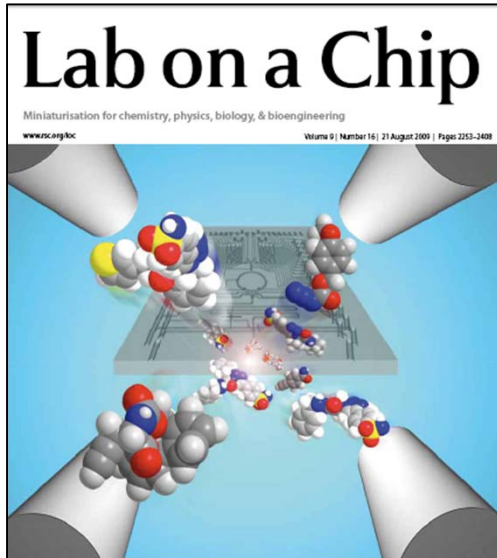

Long-term NIST on a Chip: Physical, chemical, biological...

NIST on a Chip: Why NIST?

- NIST is the nation's measurements and standards laboratory, mission to provide measurements and standards enabling innovation, productivity, research, trade, etc.
- World-leading NIST capabilities in measurement science.
- Unique NIST capabilities in micro/nanofabrication for precision measurement technology.
 - NIST Center for Nanoscale Science and Technology.
 - New Boulder Fabrication Facility and Precision Imaging Facility.
- Expanding NIST roles in manufacturing.
- Success in convening broad external partnerships: Industry, academia, Federal government, international community.

NIST on a Chip: Why NIST?

Department of Commerce
National Institute of Standards and
Technology

Three-Year Programmatic Plan
FY 2012 – FY 2014

NIST Three-Year Programmatic Plan

NIST Strategic Goals and Programmatic Planning

The breadth of technology in the U.S. economy results in a broad technical portfolio for NIST. The NIST programs must maintain technical leadership in measurement science, while also responding effectively to the rapid pace of technological innovation. NIST uses a comprehensive annual planning process to develop program priorities that support NIST's mission to promote economic prosperity and job creation in a technology-based economy.

Strategic Goals

With the aim of promoting U.S. innovation and industrial competitiveness, NIST has established three overarching strategic goals to guide and align investments in its programs:

1. Position NIST to accelerate technology development, promote advanced manufacturing, and promote industrial competitiveness.
 - Accelerate and strengthen engagement in documentary standards
 - Improve the development and delivery of measurement services
 - Enhance user access and collaboration at our unique facilities
2. Strengthen our core technical and organizational capabilities
 - Invest in the basic research required to meet the NIST mission.
 - Improve facilities and equipment to ensure NIST maintains a leading measurement capability.
 - Develop world class operations and support activities, especially in safety management.
3. Promote innovation, commercialization, and business growth
 - Support the acceleration and promotion of innovation through TIP and other programs
 - Support business success through BPEP and MEP

Programmatic Planning Priorities

Program planning for NIST seeks to align with our strategic goals and to focus on the most critical national priorities and challenges. To identify important trends, NIST continually gathers and assesses input from customers, potential stakeholders, Congress and the Administration. This input is integrated into the annual program planning process that forms the basis of this plan. Currently the programmatic plans are organized across six investment priority areas (IPAs):

1. Position NIST to accelerate technology development, promote advanced manufacturing, and promote industrial competitiveness.
 - Accelerate and strengthen engagement in documentary standards
 - Improve the development and delivery of measurement services
 - Enhance user access and collaboration at our unique facilities
2. Strengthen our core technical and organizational capabilities
 - Invest in the basic research required to meet the NIST mission.
 - Improve facilities and equipment to ensure NIST maintains a leading measurement capability.
 - Develop world class operations and support activities, especially in safety management.

NIST on a Chip: Why NIST?

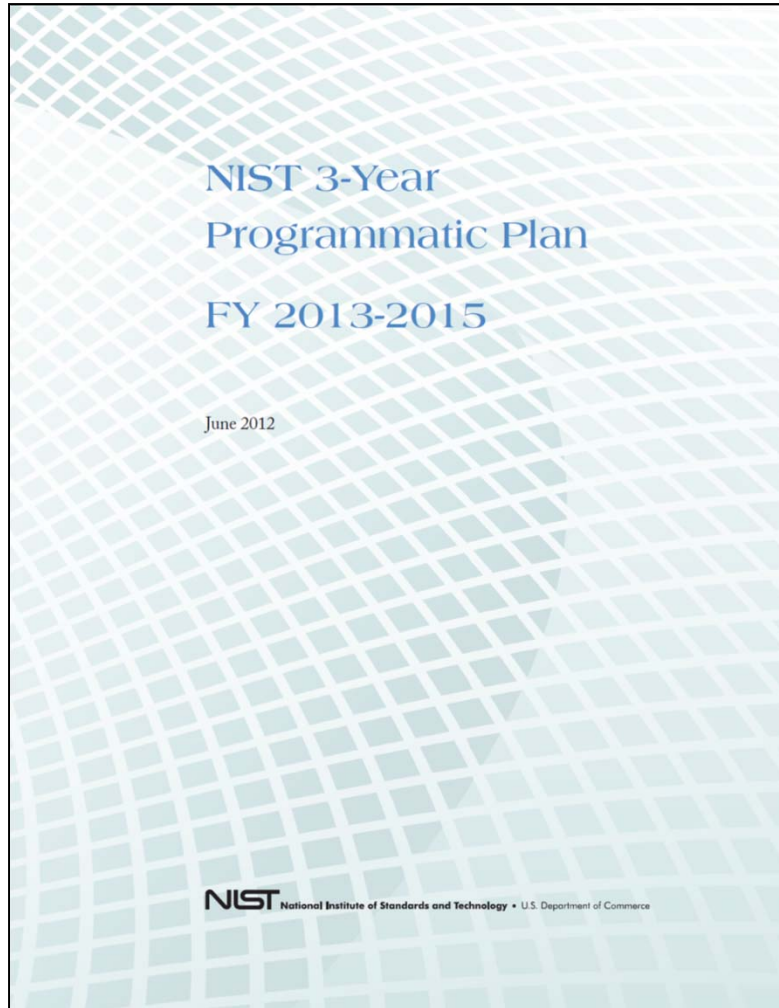

NIST 3-Year Programmatic Plan FY 2013-2015

Driving Innovation through Measurement

NIST provides measurement and calibration services via its Standard Reference Materials®, calibration services, and Standard Reference Data. More than 32,000 units of 1,300 different types of certified reference materials were sold in FY 2011 to industry, academia, and government, to assure the accuracy of millions of measurements made daily in medical clinics, manufacturing plants, crime labs, and industrial labs throughout the United States. The calibration services NIST provides help customers achieve the highest measurement quality and productivity in areas such as dimensional, electromagnetic, ionizing radiation, mechanical, optical radiation, thermodynamic, and time and frequency measurements. In FY 2011, over 18,000 calibrations were carried out on more than 2,800 objects, which underpin hundreds of thousands of additional calibrations carried out in industry, academia and government agencies. NIST Standard Reference Data are well-documented numeric data used in technical problem-solving, research, and development; over 100 types are available for use in scientific and engineering applications, with over 19 million downloads recorded in FY 2011 (excluding web-based time services).

The International System of Units (SI) is essential to science, technology, and commerce. NIST coordinates U.S. government policy on the use of the SI by federal agencies as well as on the use of the SI by U.S. industry. NIST also provides official U.S. representation to the International Bureau of Weights and Measures (BIPM), created by the Convention of the Metre Treaty of 187 and now including 55 member-states, as well as to the International Committee for Weights and Measures (CIPM), an 18-member committee whose principal task is to promote worldwide uniformity in units of measurement. In addition, NIST serves as the U.S. representative to the International Organization of Legal Metrology (OIML), a 119-member treaty organization that recommends manufacture and use requirements for legal metrology applications.



NIST has developed a nanoindentation test method that presses a diamond tip into an integrated circuit (IC) to measure the toughness of the insulating films contained within the IC. This technique is aimed at developing standards and testing methodology that will improve reliability and manufacturability of ICs
(Credit: Dylan Morris/NIST)



Artist's conception of the first "frequency comb" in the extreme ultraviolet band of the spectrum, which contains high-energy light less than 100 nanometers (nm) in wavelength, created by physicists at JILA. Laser-generated frequency combs are the most accurate method available for precisely measuring frequencies, or colors, of light (Credit: Baxley/JILA)

6

NIST on a Chip: Why NIST?

Priorities for NIST, FY 2013-2015

Priorities for NIST, FY 2013-2015

For FY 2013 – 2015, NIST will align its programs with the following strategic priorities to ensure that targeted program investments meet its mission of advancing U.S. innovation and industrial competitiveness.

Strengthening U.S. advanced manufacturing capabilities:

NIST supports long-term U.S. economic competitiveness by strengthening development and deployment of advanced manufacturing capabilities. NIST will:

- Develop and deliver the measurement science tools that will support advanced manufactur-

Strengthening U.S. advanced manufacturing capabilities:

NIST supports long-term U.S. economic competitiveness by strengthening development and deployment of advanced manufacturing capabilities. NIST will:

- Develop and deliver the measurement science tools that will support advanced manufacturing technologies (including materials modeling, nano and biomanufacturing, sensors, quality control processes, robotics, and other enabling technologies);



(Credit: Rainer Plendl/Shutterstock)

NIST on a Chip: Why NIST?

Priorities for NIST, FY 2013 - 2015

Accelerating technology transfer and commercialization:

Technology transfer is the process by which NIST knowledge, facilities and capabilities are deployed to fulfill public and private needs, and NIST plays a unique role in advancing the federal government's technology transfer goals. Technology transfer enables NIST to utilize its measurement science, standards, technology, and external partnership programs to fulfill its responsibility to promote U.S. innovation and industrial competitiveness. The October 2011 Presidential Memorandum, "Accelerating Technology Transfer and Commercialization of Federal Research in Support of High-Growth Businesses," challenges all federal agencies to increase the successful outcomes of technology transfer while simultaneously achieving excellence in basic and mission-focused research activities. NIST's responsibility for tracking and measuring the impact of technology transfer activities from federal laboratories represents a distinctive policy role.

Accordingly, NIST will:

- Establish and implement a five-year plan to increase technology transfer activities with external partners, including private firms, research organizations, and non-profit entities;
- Develop a comprehensive definition of the full range of NIST's technology transfer mechanisms and execute a coordinated effort to track the outcomes and impacts of such activities;
- Exercise continuing leadership through convening the Interagency Working Group on Technology Transfer to identify opportunities for improving technology transfer from Federal laboratories, and support OMB and OSTP in the review and monitoring of agency plans;
- Improve and expand the collection of metrics and develop rigorous economic impact models and tools for technology transfer; and
- Establish new competitive Centers of Excellence in measurement science areas defined by NIST, which will provide an interdisciplinary environment for NIST, academia and industry to collaboratively carry out basic and applied research with the end goal of enabling innovation and technology transfer.

NIST on a Chip: Why NIST?

A REVIEW OF THE MANUFACTURING-RELATED PROGRAMS AT THE NATIONAL INSTITUTE OF STANDARDS AND TECHNOLOGY

FISCAL YEAR 2012

Panel on Review of the Manufacturing-Related Programs at the National Institute of Standards and Technology

Laboratory Assessments Board

Division on Engineering and Physical Sciences

NATIONAL RESEARCH COUNCIL
OF THE NATIONAL ACADEMIES

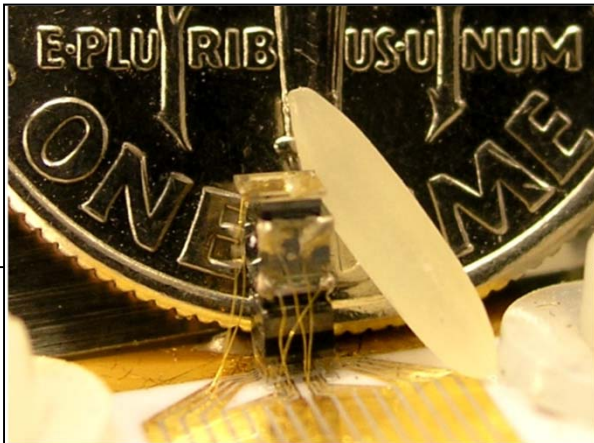

“The technical merit and scientific caliber of the work in the Nanomanufacturing area are impressive. Much of the work is among the best in the world, evidencing the unique skills and contributions of NIST.”

“For example, one panel member called the ‘rice-sized’ atomic clock developed at NIST the most significant example of nanomanufacturing that he had seen, noting that this is paradigm-shifting work which the automotive industry can use today if the clock can be manufactured cost-effectively.”

NIST on a Chip: Measurement Science Research Examples

Only a small sample of current and developing NIST on a Chip activities.

Time and Frequency; Voltage

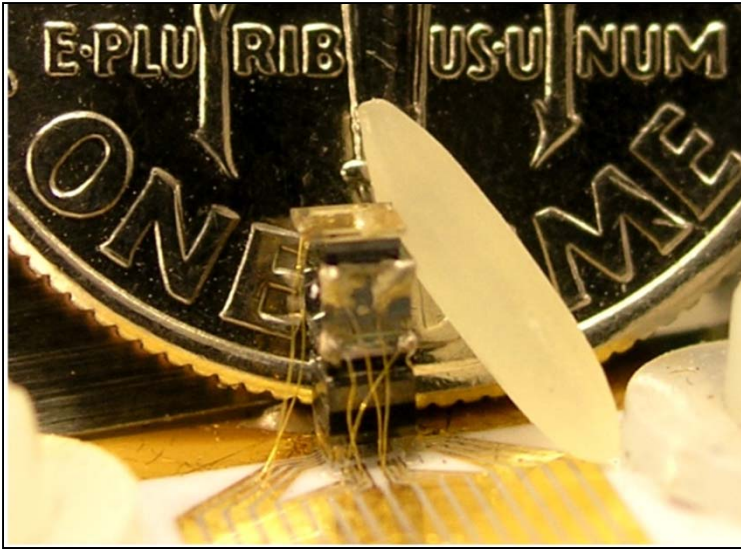

NIST chip-scale atomic clocks and magnetometers.

Atomically precise measurements.

AA battery power (~ 0.01 W).

NIST Josephson quantum voltage standard.

Intrinsic (quantum-based) standard.

$\sim 300,000$ junctions.

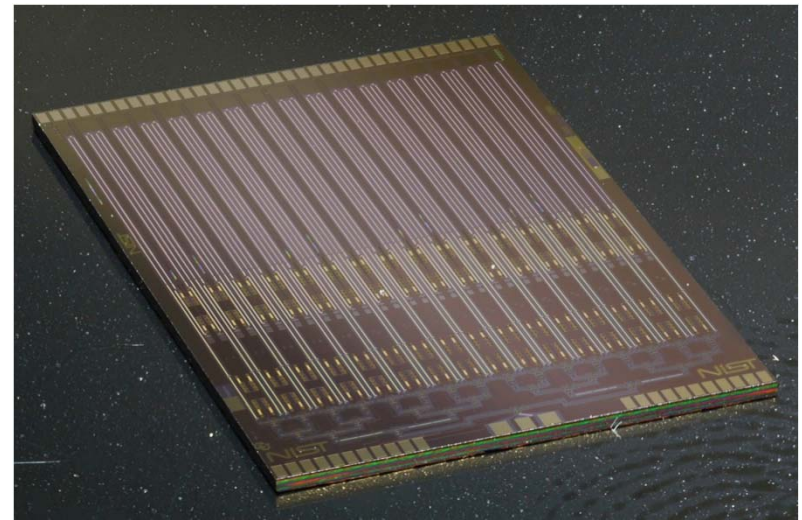

Time and Frequency; Voltage



NIST chip-scale atomic clocks and magnetometers.

Atomically precise measurements.

Further Discussion and Lab Tour

NIST Josephson
standard.

Intrinsic (quantum-based) standard.

~300,000 junctions.

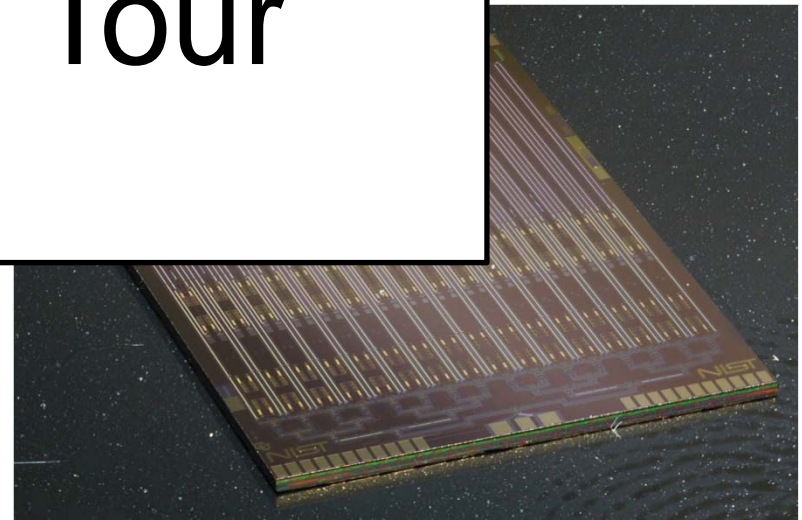

NIST Chip-Scale Atomic Magnetometry

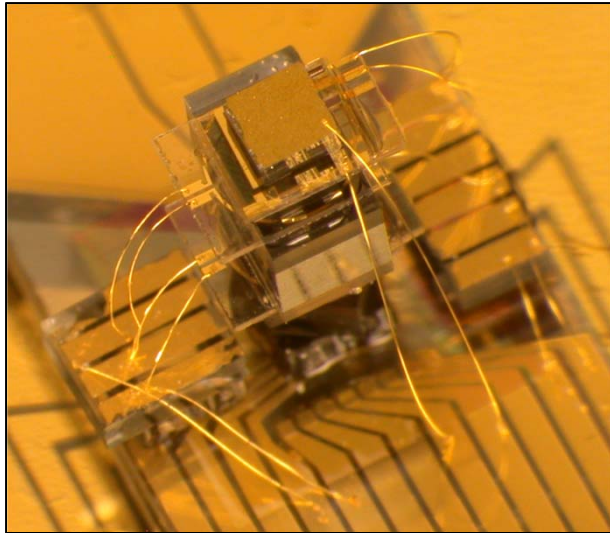

Based on NIST chip-scale atomic clock technology.

SQUID-level performance.

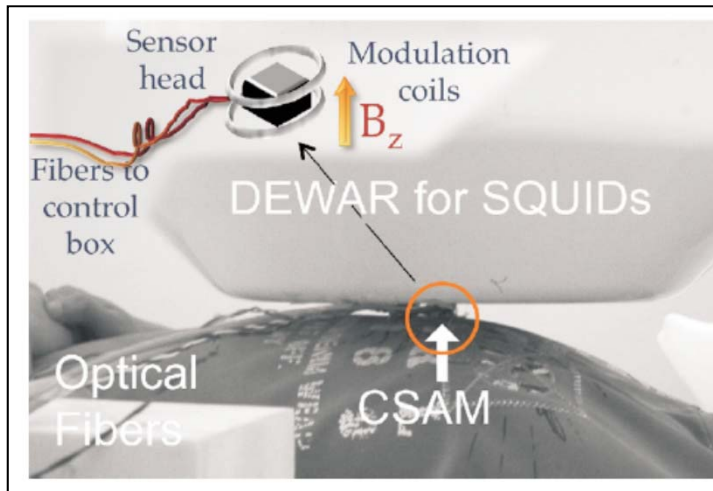
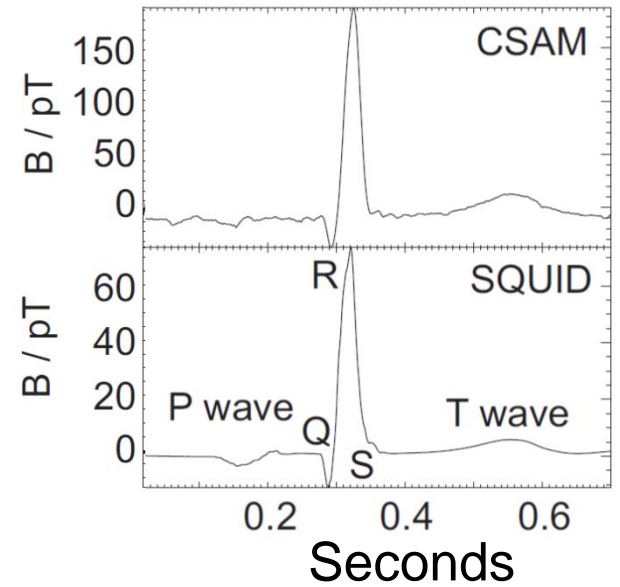

Magnetocardiography with CSAM and SQUID

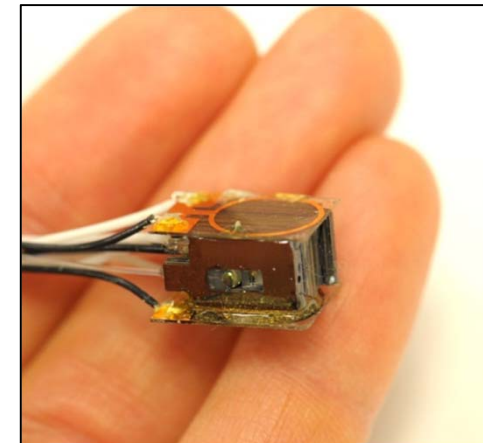

NIST Chip-Scale Fluid Metrology

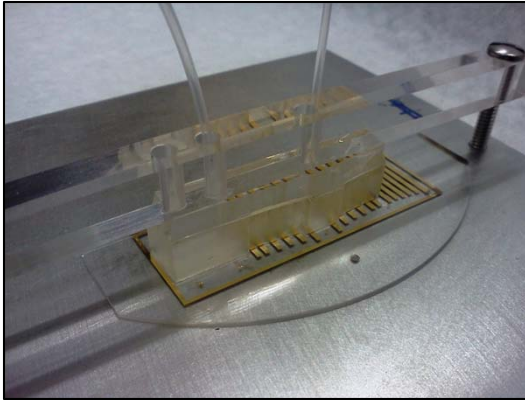

Micron-sized particle manipulation using Surface Acoustic Wave (SAW) device

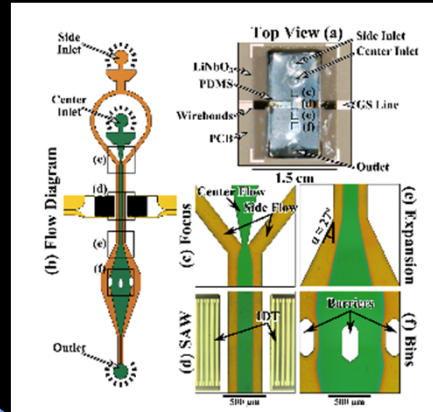

Integrate microfluidics and microelectronics for electronic-based measurement of fluid properties.

- Electromagnetic (permittivity, permeability, conductivity).
- Thermal (conductivity, heat capacity).
- Mechanical (viscosity, density, shear modulus).

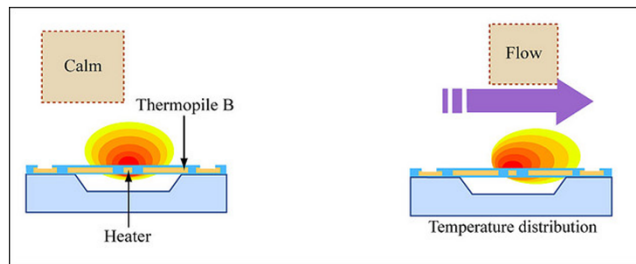
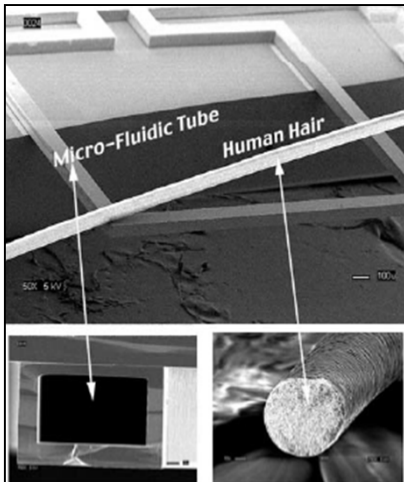

NIST Chip-Scale Force/Acceleration Metrology

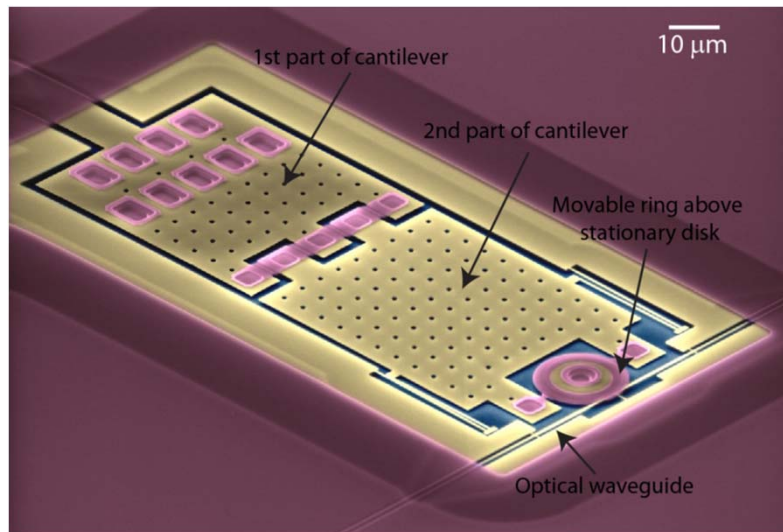
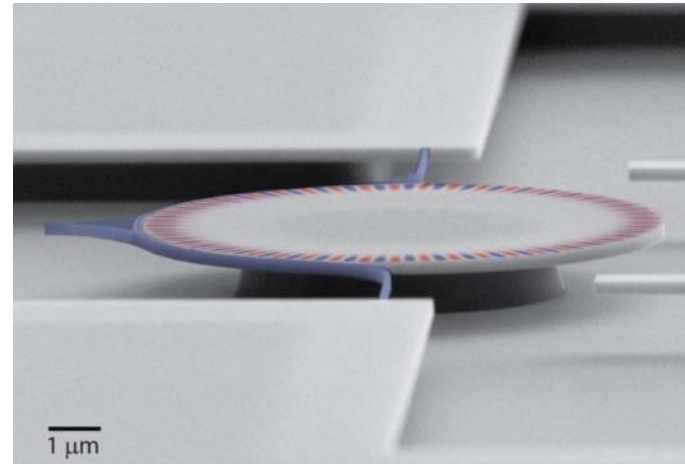
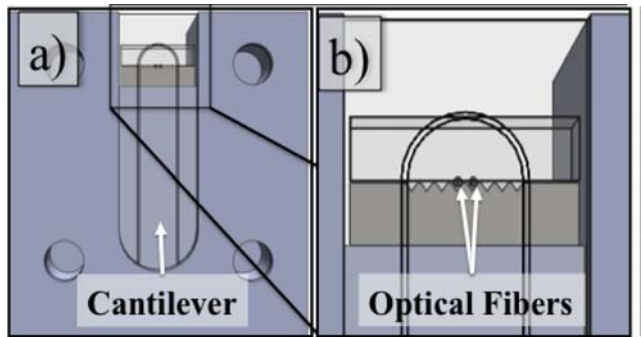

Coupling of mechanical displacement with optical signals for interferometric quality measurements of force and displacement.

NIST Chip-Scale Nanophotonics for Force and Displacement

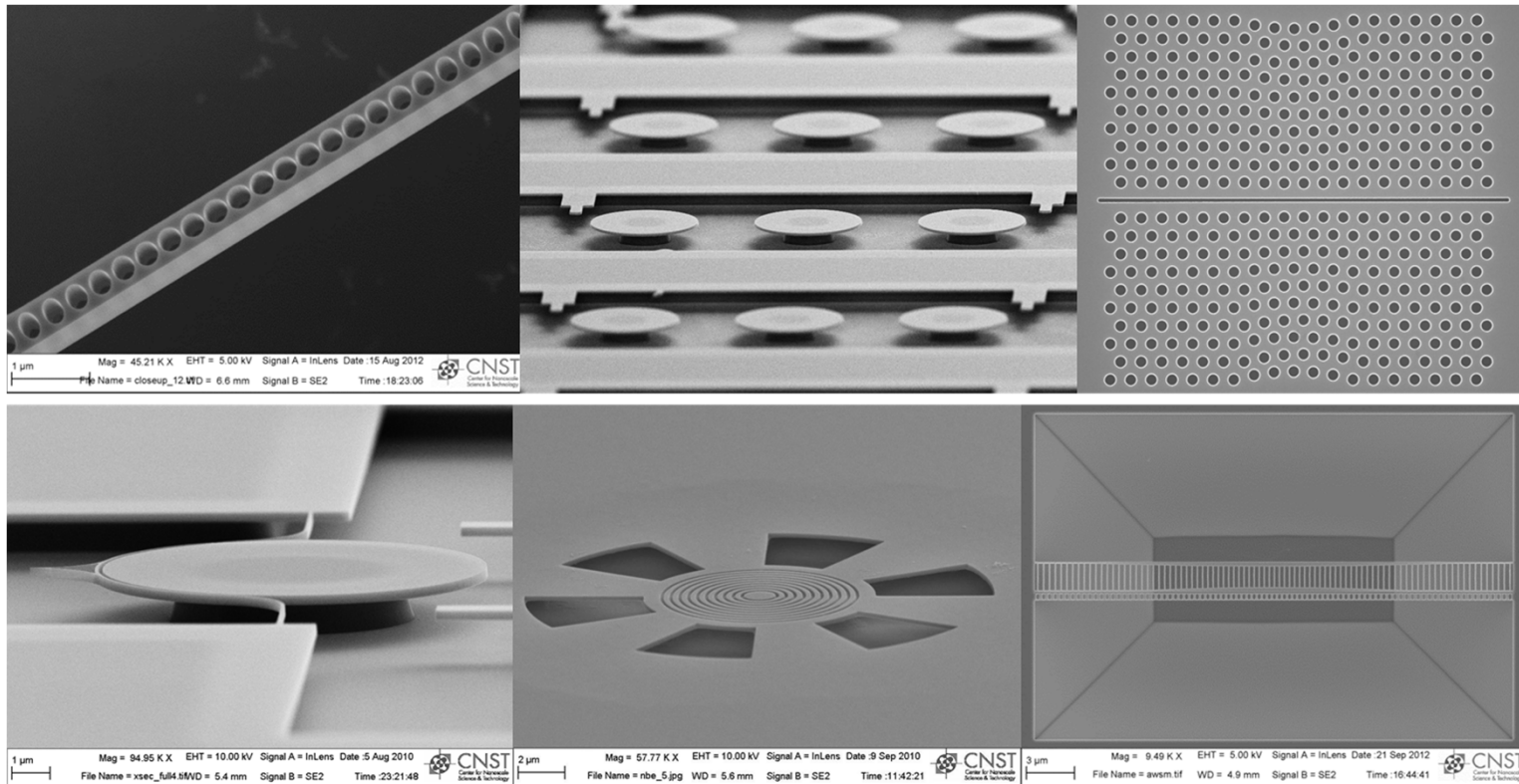

- Cavity optomechanical systems for sensitive force and displacement metrology.
- Interface micro/nanophotonic systems with macroscopic fiber and free-space optics.

NIST Chip-Scale Force/Acceleration Metrology

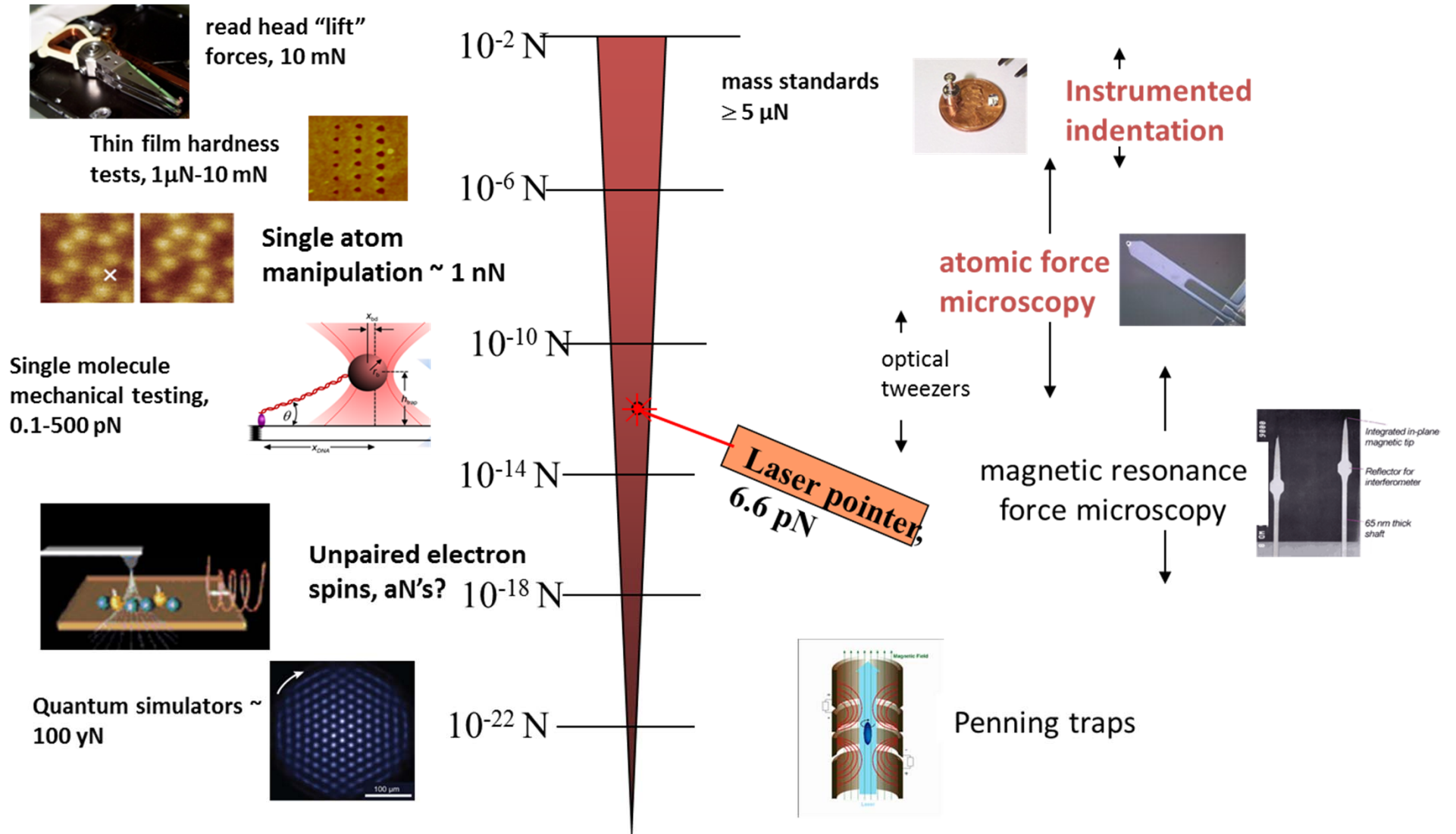

NIST Chip-Scale Temperature Metrology

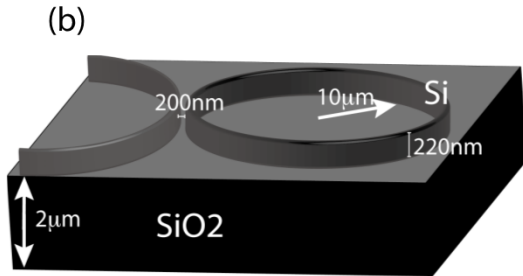

Silicon optomechanics / thermo-optics.
Temperature from thermal (Brownian) motion.
Measurements in 0.001 K to 1,000 K range.

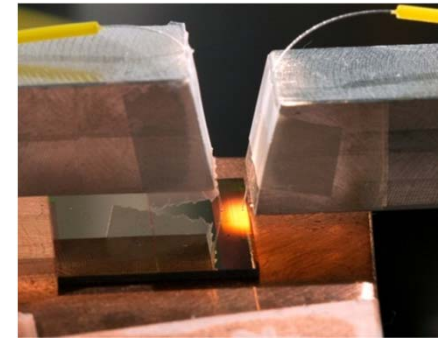
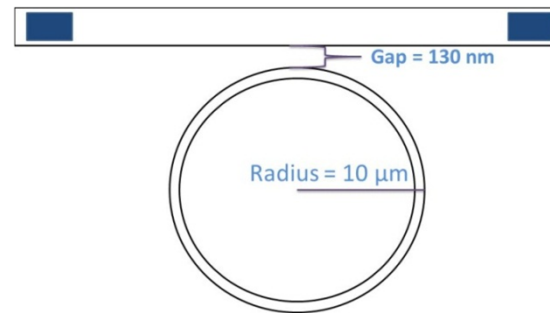
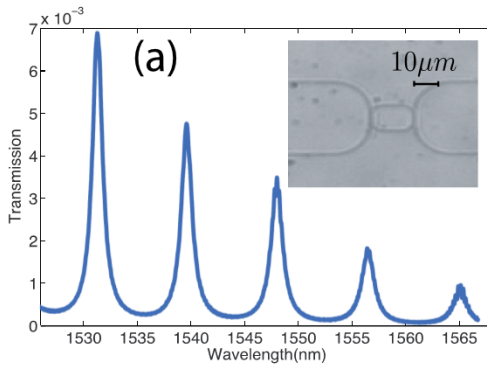

Photonic temperature sensor provides standard platinum resistance thermometer-level accuracy (1 mK) in package 1,000 times smaller.

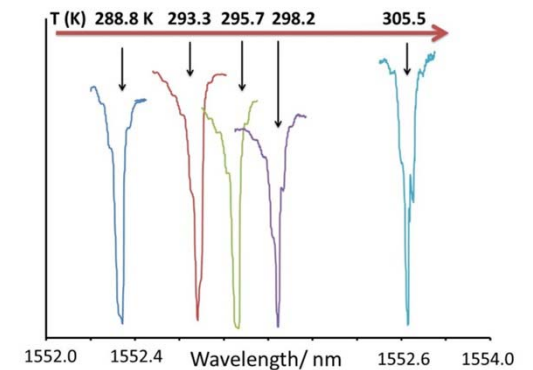

NIST Chip-Scale Laser Frequency Combs

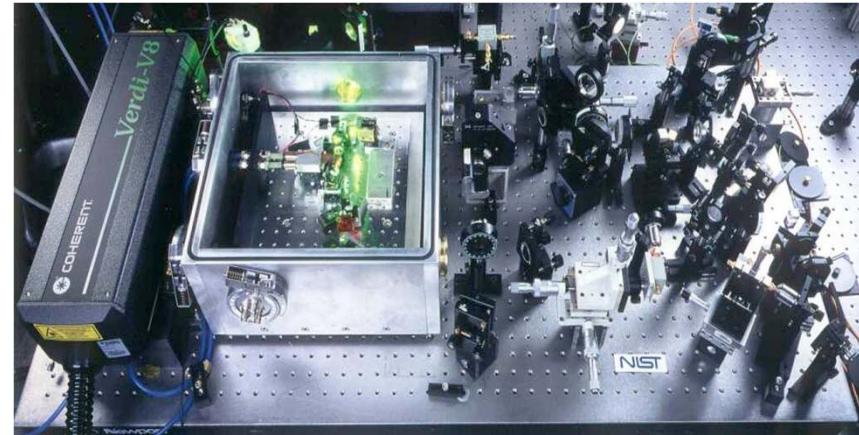
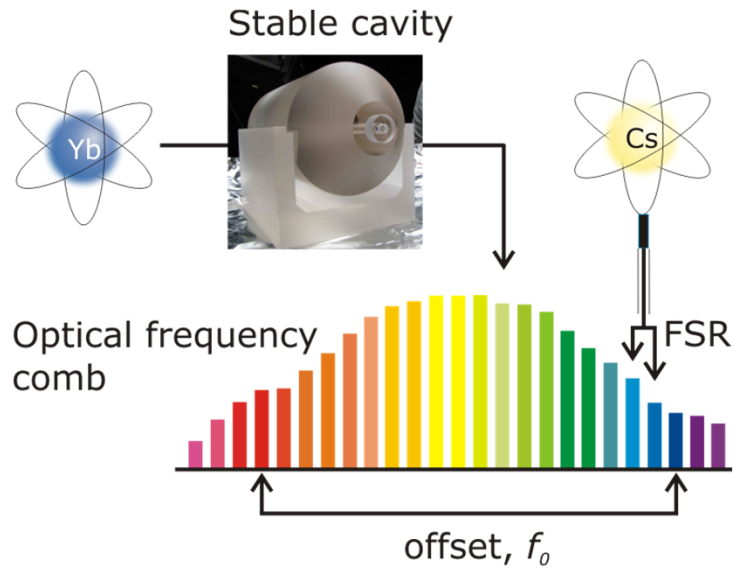

2005 Nobel Prize in Physics
for NIST's Jan Hall

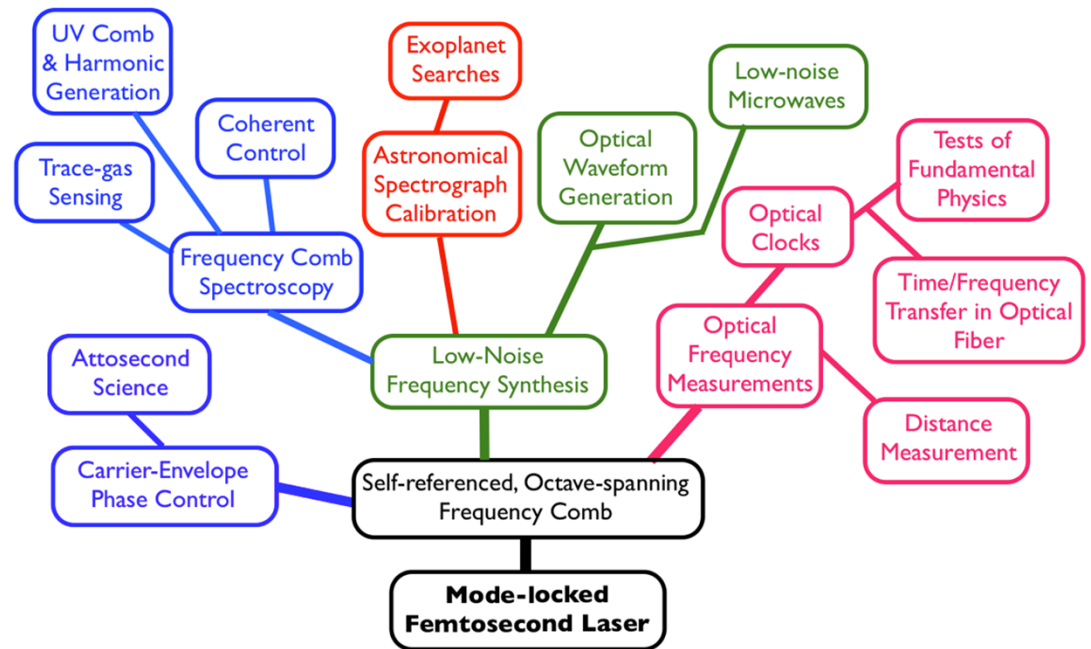

NIST Chip-Scale Laser Frequency Combs

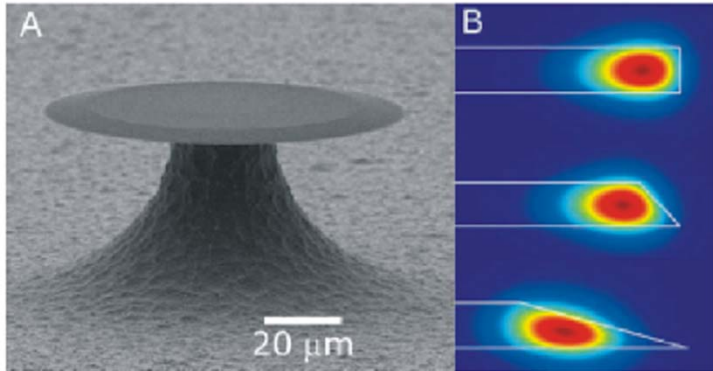

Wedge resonators
(CalTech partnership)

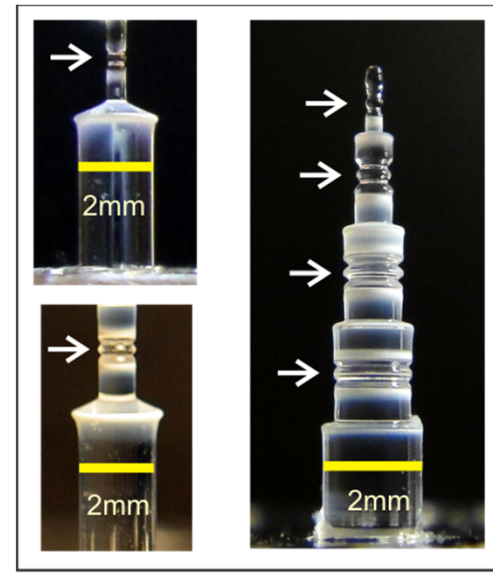

NIST microcombs

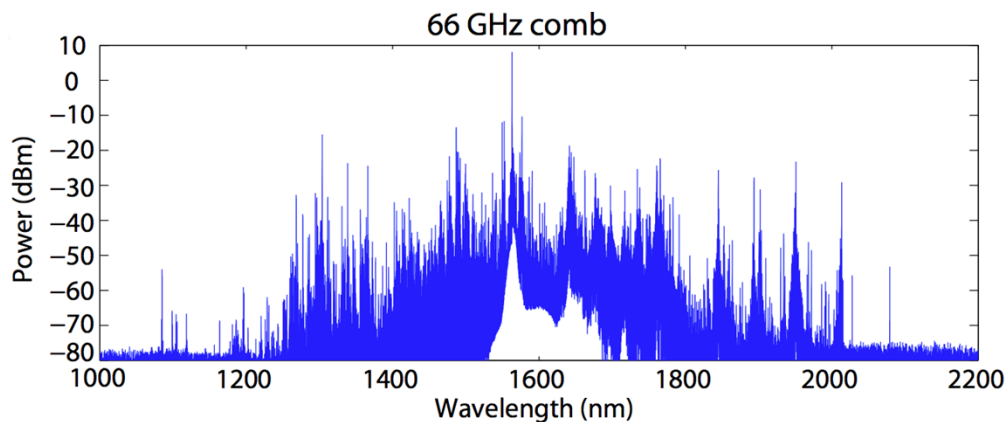

Laser frequency combs
key tool for chip-scale
precision metrology and
for coupling chip-scale
measurements to “outside
world.”

NIST on a Chip: Measurement Science Research Examples

Only a small sample of current NIST technologies and ideas shown today.

Many more examples available...

NIST on a Chip: Potential Integration of Measurements

One example:

Atoms

- Stability and accuracy from atomic structure
 - Clocks
 - Magnetometers
 - Atom interferometers
- Optically excited and detected

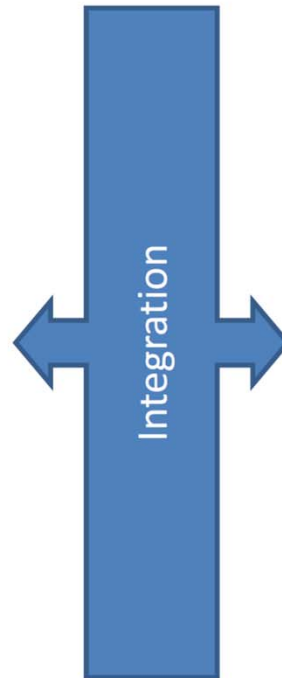

Microsystems Technology

- MEMS
 - Atom confinement
 - Compact, parallel fab
- Photonics
 - Atom interrogation
 - Coupling to outside world
- Micromechanics
 - Resonant microstructures

NIST on a Chip: Potential Integration of Measurements

Time and frequency.

Magnetic field.

- Precision measurement of atomic transition in chip-scale atomic clock or laser-cooled atom chip.

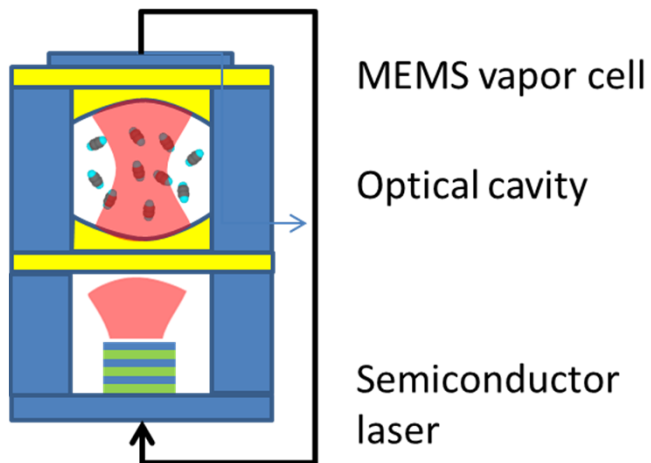
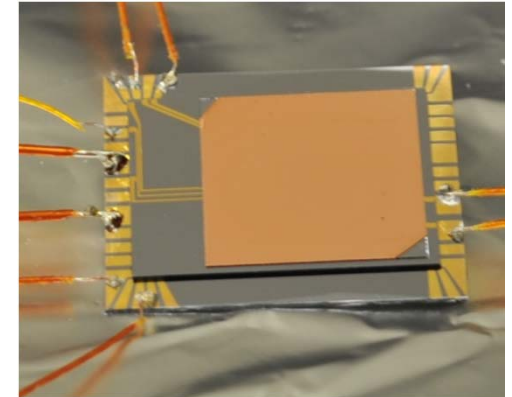
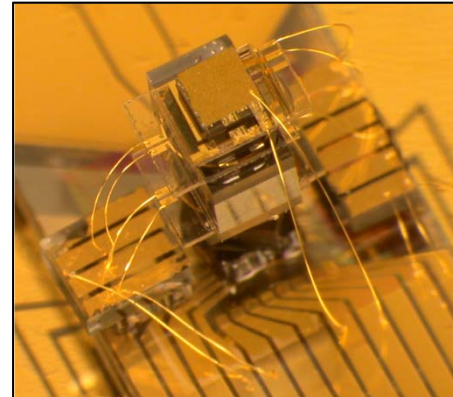

Length.

- Laser frequency comb stabilized to transitions in molecules in microcell.

NIST on a Chip: Potential Integration of Measurements

Temperature.

- Precision measurement of atom/molecule transition width.

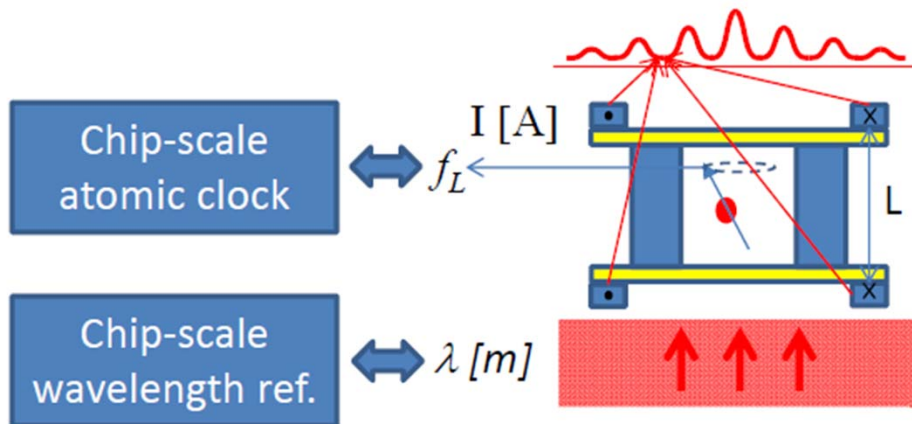
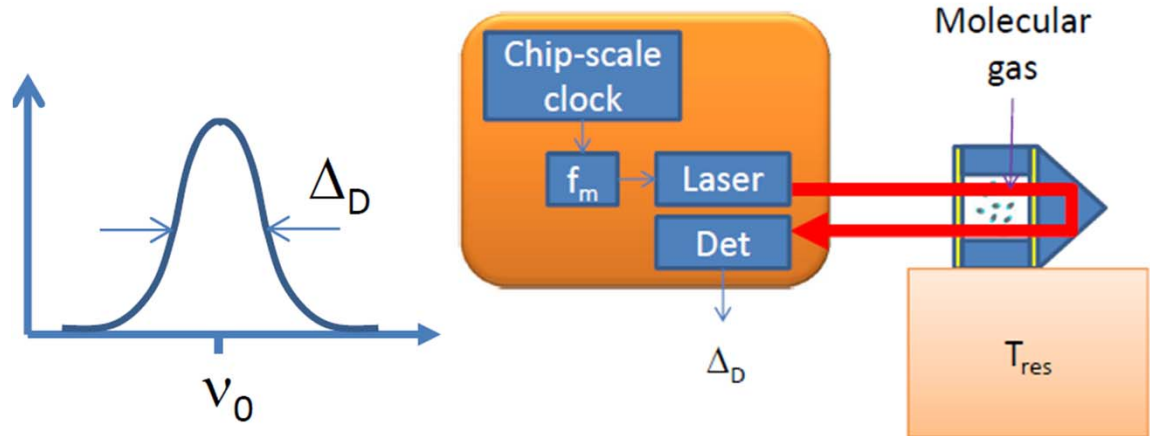

Electric current.

- Precision measurement of atomic frequencies altered by magnetic field generated by electric current.

NIST on a Chip: Potential Integration of Measurements

Time, Electrical, Magnetic,
Temperature, Length, etc.

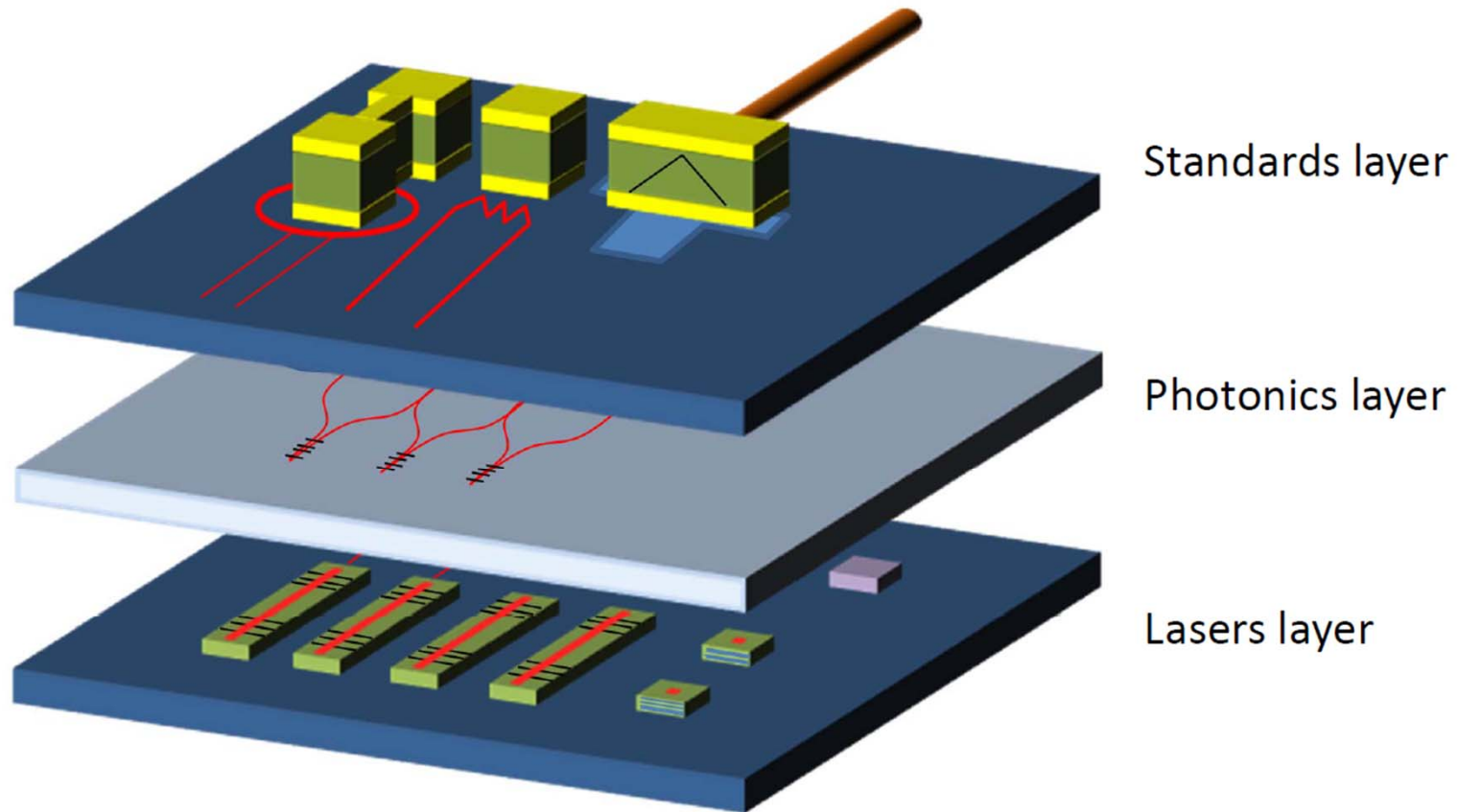

NIST on a Chip: Potential Integration of Measurements

Another example:

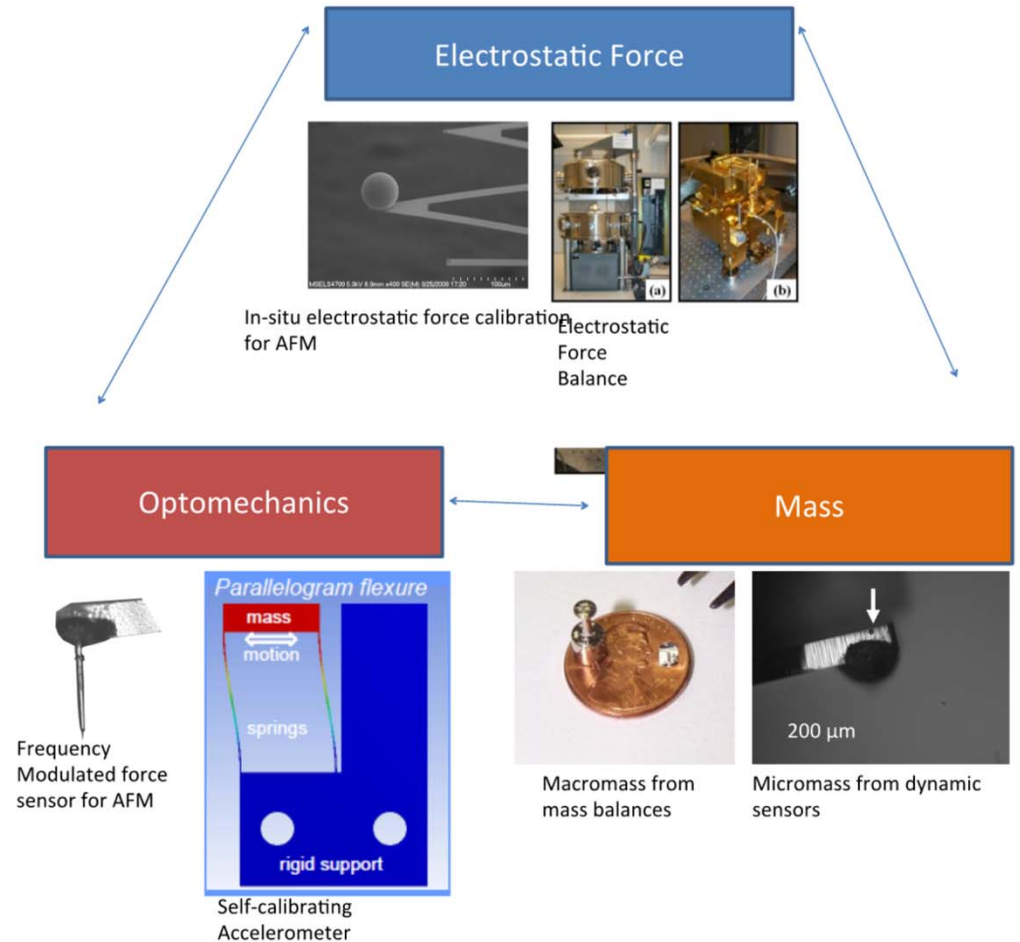
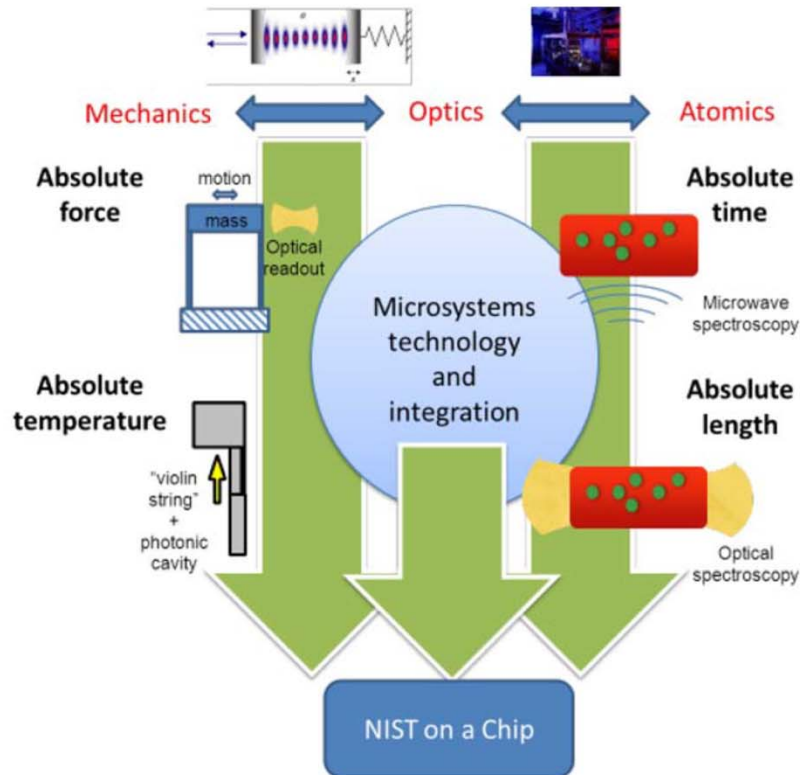

NIST on a Chip: Enables New Measurement Science

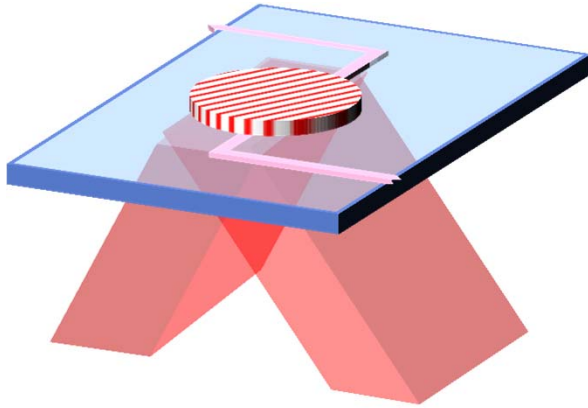

- On-chip optical trapping for precision measurement of fundamental physical constants (e , h , α , μ , etc.).

Unique measurements and technologies resulting from microscale interactions.

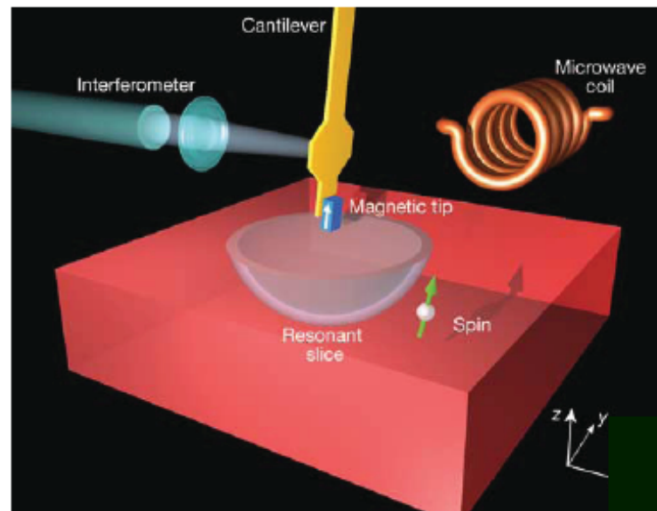

2012 Nobel Prize in Physics for NIST's Dave Wineland

- Opto-mechanical resonators for fundamental physics research, quantum computing, quantum simulation, yoctoNewton force metrology, etc.

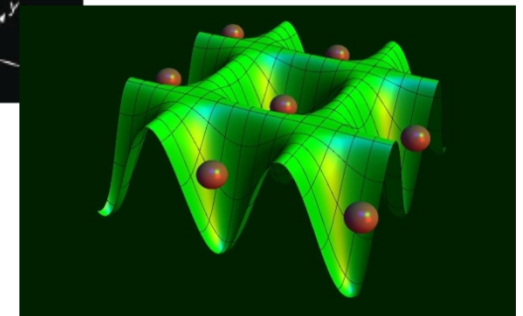

NIST on a Chip

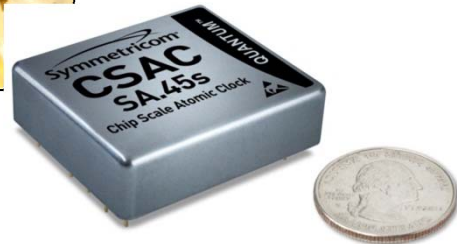
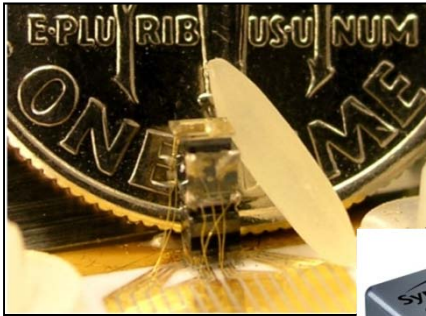

- Initial applications likely to be NIST Chips performing a single measurement or a few closely related measurements.

- Longer-term deployment: Mix of single/few measurement NIST Chips with multifunction NIST Chips.
- Initial adoption likely to be high-value applications where function, small form factor, low power more important than cost.
- Broader adoption and deployment with manufacturability improvements.

NIST on a Chip: Impacts on NIST Measurement Services

- Traditional measurement service model unlikely to disappear completely, especially for the most accurate and demanding calibrations and measurements.
- Many traditional measurement services can be eventually replaced by NIST on a Chip.
- NIST resources freed from traditional measurements services can be redirected, such as to NIST on a Chip research programs, and to other NIST programs.
- NIST on a Chip has the potential to more tightly couple NIST and external partners (industry, academia, government) in development and provision of measurement services.

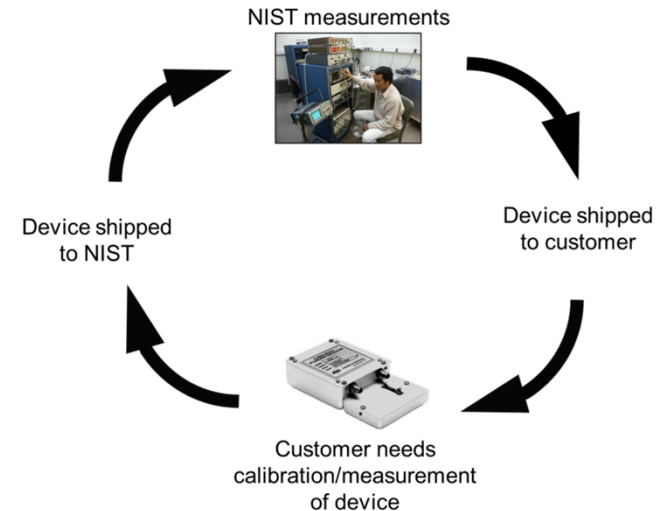

NIST on a Chip Program

Some preliminary ideas.

NIST senior management decisions and VCAT guidance needed.

Vertically integrated program:

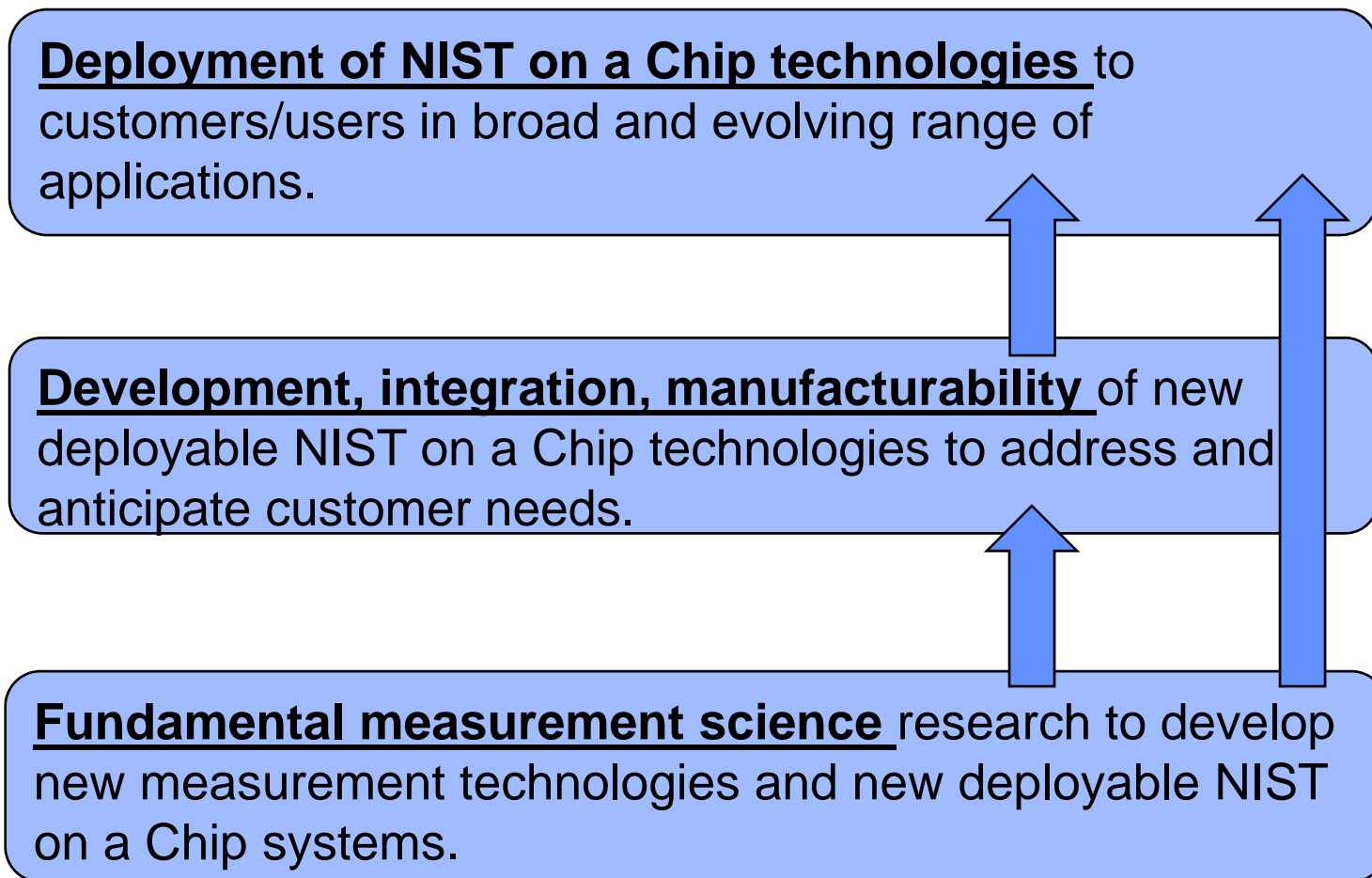

NIST on a Chip Program

- Program spans all NIST Laboratories.
- CNST and Boulder Fabrication/Precision Imaging capabilities crucial to program success.
- Strengthen and expand existing external partnerships.
 - Industry, academia, Federal laboratories.
 - For NIST on a Chip measurement science research.
 - For manufacturability considerations.
 - As potential manufacturers and marketers of NIST on a Chip products.
 - Formal and informal tech transfer.
 - To better understand and respond to customer/user needs.
- Possible future Center of Excellence?
- Management model.

NIST on a Chip Program

- Foundations of NIST on a Chip already in place and rapidly expanding.
 - Remote measurement services.
 - Intrinsic (quantum-based) standards in small form factor.
 - Integration.
 - Manufacturability.
- NIST-wide program with coordinated external partnerships will strengthen and accelerate all areas.
 - Integration, manufacturability areas of particular need.

NIST on a Chip Program

- Next steps:
 - Internal NIST workshop, share and inventory NIST on a Chip technologies, proposals, brainstorm new approaches, etc.
 - November 1-2 in Boulder.
 - Preliminary recommendations to NIST senior management on NIST on a Chip program.
 - Public NIST on a Chip workshop.
 - Invite industry, academia, Federal agencies, other national metrology institutes.
 - Better clarify customer needs and opportunities, partnership opportunities, etc.
 - More complete recommendations to NIST senior management on NIST on a Chip program coordinated with external partners.

NIST on a Chip Program

Next steps:

- Begin formal coordinated NIST on a Chip program.
 - Near-term and long-term strategic plans.
 - Resources.
 - Leadership for cross-cutting program.
 - Formalize external partnerships.
- Some business model issues to consider:
 - NIST on a Chip as NIST product, or commercial product, or combination.
 - External partnership and tech transfer models.
 - Challenges of industry/academia/government partnerships when IP and profitable products are likely.

NIST on a Chip Program

- O'Brian opinions only, not necessarily NIST positions.
 - Important to keep appropriate balance of:
 - Fundamental measurement science research.
 - Directed NIST on a Chip development.
 - Deployed NIST on a Chip technologies.
 - Crucial to ensure “bottom up” ideas are carefully considered.
 - Vision, plans, initial execution for NIST chip-scale atomic device program and NIST on a Chip were “bottom up.”

NIST on a Chip Program

VCAT advice and guidance needed:

- Does this approach make sense to you?
- What suggestions do you have for changes in these broad plans?
- What applications can you see in your industry/areas of expertise? In other industries/technical areas?
- What are the best ways to engage industry and other external partners in planning for the most effective NIST on a Chip measurements?
 - Includes potential for a broader NIST-sponsored workshop(s) engaging external partners, following up on the internal NIST November 1-2 workshop.

NIST on a Chip Program

VCAT advice and guidance needed:

- What are the best ways to engage industry and other external partners in joint research and development with NIST on NIST on a Chip technologies?
- What suggestions do you have for building support for a NIST on a Chip program among industry, Congress, other stakeholders?
- What suggestions do you have for better articulating and explaining the NIST on a Chip vision to various stakeholders?
- What sorts of business models make sense for NIST, potential NIST on a Chip manufacturers, and customers/users?
- Any other input?